

TARIFA 2023

Mediterránea de Válvulas

ΧΟΨΩU ÁÖÒÜÖÒÁΦΔJÓÚVÇT ÓÜÒΒΕGH





TARIFA 2023

CODIGOS QR DE DESCARGA



CATALOGO 2023
Descargar PDF



TARIFA 2023
Descargar EXCEL



NOVEDADES 2023
Descargar PDF

Este catalogo ANULA cualquier otro de fecha de edición anterior

Fecha Edición de este catálogo: 01/09/2023



Queda prohibida la reproducción total o parcial de este catálogo sin autorización expresa y por escrito de Mediterránea de Válvulas, S.L. que se reserva el derecho a modificar total o parcialmente el contenido de dicho catálogo.

ÍNDICE



VÁLVULAS DE LATÓN		10 - 14
Válvulas escuadra	10	
Grifos lavadora	12	
Accesorios	14	
GRIFERÍA TEMPORIZADA		16 - 22
Grifos lavabo	16	
Grifos mural	17	
Grifos fuente	17	
Grifos ducha	19	
Grifos urinario	20	
Fluxómetros y tubos	20	
Rejilla urinario	21	
GRIFOS DE PEDAL		24 - 26
Grifos un pedal	24	
Grifos dos pedales	25	
Caños fijos y giratorios	25	
GRIFERÍA MEDICAL		28 - 30
GRIFERÍA SERIE CATI		32
GRIFERÍA SERIE MINIMALISTA		33
GRIFERÍA SERIE ESFERA		34
GRIFERÍA SERIE NICE		35
GRIFERÍA TERMOSTÁTICA		36
GRIFERÍA HIGIÉNICA WC/BIDET		38
COLUMNAS DE DUCHA		40
GRIFERÍA DE FREGADERO		42 - 46
Monomandos	42	
Baterías	45	
Monoblocs	46	

ÍNDICE



GRIFERÍA DE UN AGUA	48 - 54
Monomandos	48
Baterías	50
Office	51
RECAMBIOS DE GRIFERÍA	56
ACCESORIOS DE GRIFERÍA	58 - 62
Fijaciones y excéntricas	58
Conexiones flexibles	59
Accesorios grifo extraíble	59
Cartuchos y monturas	60
Atomizadores	61
Adaptadores grifería	62
COMPLEMENTOS DE BAÑO	64 - 72
Mangos de ducha	64
Flexos de ducha	67
Rociadores	68
Brazos y barra de ducha	70
Soportes de ducha	71
Barras de seguridad	72
VÁLVULAS DESAGÜE	74 - 80
Válvulas click-clack	74
Válvulas automáticas y manuales	76
Válvulas bañera y ducha	77
Tapa orificios y tapones	79
Cadena y anillas	80
FILTROS DESAGÜE	82
SIFONES DESAGÜE Y ACCESORIOS	84 - 88
ENCHUFES DE GOMA	90
CABEZALES UNIVERSALES, ACCESORIOS Y REPUESTOS	92 - 96
CONEXIONES FLEXIBLES	98 - 104
Serie A	98
Termo "Serie Súper"	100
Batería de contador	102
Bomba de agua	103
CONEXIONES PARA LAVADORA	106

ÍNDICE



VÁLVULAS ESFERA EMPOTRAR Y ACCESORIOS		108 - 110
VÁLVULAS DE CONTROL		112 - 116
Soldar	112	
Roscar	113	
Recambios	114	
VÁLVULAS DE ESFERA		118 - 122
Válvulas esfera palanca	118	
Válvulas esfera cuadradillo	119	
Válvulas esfera palomilla	120	
Válvulas esfera mini	121	
GRIFOS CURVOS Y ACCESORIOS		124 - 126
Grifo curvo esfera	124	
Grifo curvo candado	125	
Grifo curvo polipropileno y antihielo	125	
Racor, enchufe, unión y boquilla adaptables	126	
GRIFOS DECORATIVOS		128 - 130
REDUCTORES DE PRESIÓN Y MANÓMETROS		132 - 134
VÁLVULAS DE RETENCIÓN Y FILTROS		136 - 140
Válvulas de retención H-H	136	
Filtros	137	
Válvulas de retención M-M	137	
Válvulas de retención clapeta	138	
Filtro colador tipo "Y"	138	
Válvulas de compuerta	138	
Válvulas esfera 3 vías	139	
Válvulas esfera con retención incorporada	139	
Válvulas esfera contador y accesorios	140	
RACORES DE CONTADOR Y ACCESORIOS		142
ACCESORIOS TUBO POLIETILENO		144 - 150
Anillo de nylon	144	DESCATALOGADO
Anillo de latón	146	
Anillo de acero inox. con bridas	148	
Recambios	150	
GRIFOS FLOTADORES Y BOYAS		152 - 156
Flotadores	152	
Boyas	154	
Accesorios	156	

ÍNDICE



CISTERNA E INODORO	158 - 168
Descargadores y gomas	158
Cisterna y accesorios	161
Tiradores	162
Gomas y juntas	163
Manguitos y tapones	164
Tapas inodoro	166
Accesorios de baño	167
ACCESORIOS DE FIJACIÓN	170 - 172
RACORERÍA DE LATÓN ROSCAR	174 - 188
Machón doble	174
Marsella hexagonal	176
Reducción hexagonal	177
Reducción lisa	177
Codos	178
Te H-H-H	180
Manguitos	181
Tapón Hembra	182
Tapón Macho	183
Unión 3 piezas	184
Racor depósito uralita	185
Arandela acero y latón	185
Tuercas correderas	186
Alargaderas cilíndricas pulidas y cromadas	186
Codo 3 bocas, cruz 4 bocas, Te 5 vías	187
Bebedero de cerdo	187
Curvas de 90°	187
Collarines	188
Manguitos electrolíticos	188
RACORERÍA DE LATÓN SOLDAR	190 - 192
Codos	190
Enlaces y entronques	191
Te H, tapones, curva desviación	192
RACORERÍA DE LATÓN PARA RIEGO	194 - 198
NIPPELS GALVANIZADOS	200 - 202
VÁLVULAS DE FUNDICIÓN	204 - 206
Racores unión	204
Abrazaderas de reparación	205
Conexiones manguera	206
Manguitos antivibratorios	206



ÍNDICE



CALEFACCIÓN	208 - 218
Purgadores automáticos	208
Purgadores manuales	209
Válvulas de seguridad y retención	209
Válvulas y detentores manuales para radiador	210
Válvulas termostatzables para radiador	212
Colectores	213
Complementos colectores	214
Termostatos y cronotermostatos	215
Tuercas	216
Florones y tapones	217
Soportes radiador y casquillo	218
JUNTAS Y ARANDELAS	220 - 224
Juntas tóricas	220
Juntas planas	221
Arandelas de goma y juntas de fibra	222
Juntas klinger y juntas de teflón	223
MEMBRANAS	226
SOLETAS Y PORTASOLETAS	228
ACCESORIOS DE SELLADO	230 - 231
ACCESORIOS PARA GAS	234 - 240
Reguladores y goma de butano	234
Gas hermeto y soldar	235
Soportes y tapas contador	239
ACCESORIOS DE VENTILACIÓN	242 - 244
Rejillas	242
Difusores	244
SUMIDEROS, CALDERETAS Y BOTE SIFÓNICO	246
ACCESORIOS DE COBRE	248 - 257
Racor recto	248
Racor curvo	250
Manguitos	251
Codos	253
Tapón Hembra	254
Curva de 90°	254
Curva de 45° y curva desviación	255
Te H-H-H	256

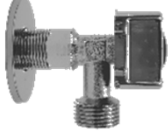
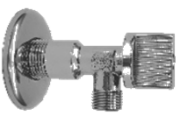

VÁLVULAS DE LATÓN

Válvulas escuadra		10
Grifos lavadora		12
Accesorios		14

VÁLVULAS DE LATÓN



VÁLVULA ESCUADRA



Código	Medida	Caja	Código Barras	€ / Ud.
10001	M 1/2" x M 3/8"	100	8435195800005	2,99
10003	M 1/2" x M 1/2"	100	8435195800029	3,73

- PN 16.
- Latón EN 12165 cromado.
- Temperatura máxima 90°C.
- Mando ABS 1/4 de vuelta con tornillo de sujeción.
- Florón en acero inoxidable.
- Eje de latón.

VÁLVULA ESCUADRA A-96

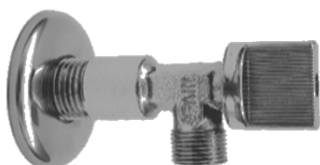

Código	Medida	Caja	Código Barras	€ / Ud.
10002	M 1/2" x M 3/8"	100	8435195800012	3,10
10004	M 1/2" x M 1/2"	100	8435195800036	3,73

- PN 16.
- Latón EN 12165 cromado.
- Temperatura máxima 90°C.
- Mando ABS 1/4 de vuelta con tornillo de sujeción.
- Florón en acero inoxidable.
- Eje de latón.
- **SISTEMA PATENTADO**

VÁLVULA ESCUADRA A-96 MINI M-H



Código	Medida	Caja	Código Barras	€ / Ud.
10005	H 3/8" x M 3/8"	100	8435195800043	3,29
10006	H 1/2" x M 3/8"	100	8435195800050	3,39

- PN 16.
- Latón EN 12165 cromado.
- Temperatura máxima 90°C.
- Mando ABS 1/4 de vuelta con tornillo de sujeción.
- Eje de latón.
- **SISTEMA PATENTADO**

VÁLVULA ESCUADRA ANTICAL

**NUEVO
Producto**

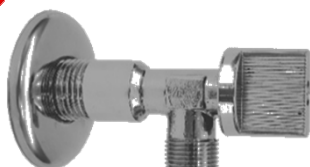

Código	Medida	Caja	Código Barras	€ / Ud.
10007	M 1/2" x M 3/8"	100	8435195848045	2,90

- PN 16.
- Fabricada en latón.
- Temperatura máxima 90°C.
- Mando ABS 1/4 de vuelta con tornillo de sujeción.
- **Eje de polímero antical.**
- Juntas interiores de EPDM.

VÁLVULAS DE LATÓN



VÁLVULA ESCUADRA A-96 LARGA



Código	Medida	Caja	Código Barras	€ / Ud.
10010	M 1/2" x M 3/8" 86 mm.	100	8435195800074	4,30
10012	M 1/2" x M 3/8" 96 mm.	100	8435195825442	4,10

- PN 16.
- Latón EN 12165 cromado.
- Temperatura máxima 90°C.
- Mando ABS 1/4 de vuelta con tornillo de sujeción.
- Florón en acero inoxidable.
- Eje de latón.
- **SISTEMA PATENTADO**

VÁLVULA ESCUADRA CILÍNDRICA



Código	Medida	Caja	Código Barras	€ / Ud.
12101	M 1/2" x M 3/8"	100	8435195821482	6,40
12102	M 1/2" x M 1/2"	50	8435195825497	6,45

- PN 16.
- Latón EN 12165 cromado.
- Temperatura máxima 90°C.
- Florón en acero inoxidable.
- Montura cerámica.

VÁLVULA ESCUADRA MINIMALISTA



Código	Medida	Caja	Código Barras	€ / Ud.
12105	M 1/2" x M 3/8"	100	8435195821499	6,60
12106	M 1/2" x M 1/2"	50	8435195825503	6,80

- PN 16.
- Latón EN 12165 cromado.
- Temperatura máxima 90°C.
- Florón en acero inoxidable.
- Montura cerámica.

VÁLVULA ESCUADRA CON FILTRO

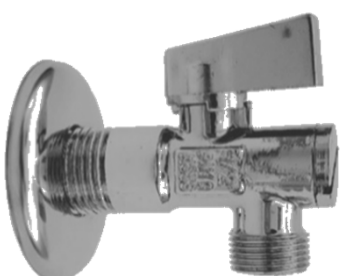

Código	Medida	Caja	Código Barras	€ / Ud.
12001	M 1/2" x M 3/8"	100	8435195820041	5,62
12004	M 1/2" x M 3/4"	50	8435195825480	5,99

- PN 16.
- Latón EN 12165 cromado.
- Temperatura máxima 90°C.
- Florón en acero inoxidable.
- Mando ABS 1/4 de vuelta con tornillo de sujeción.
- Eje de latón.

VÁLVULAS DE LATÓN



GRIFO LAVADORA

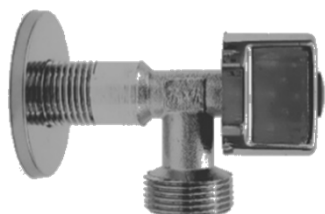

Código	Medida	Caja	Código Barras	€ / Ud.
11002	M 1/2" x M 3/4"	50	8435195800142	3,89

- PN 16.
- Latón EN 12165 cromado.
- Temperatura máxima 90°C.
- Mando ABS 1/4 de vuelta con tornillo de sujeción.
- Florón en acero inoxidable.
- Eje de latón.
- **SISTEMA PATENTADO**

GRIFO LAVADORA



Código	Medida	Caja	Código Barras	€ / Ud.
11004	M 1/2" x M 3/4"	50	8435195825459	3,39

- PN 16.
- Latón EN 12165 cromado.
- Temperatura máxima 90°C.
- Mando ABS SAFOR 1/4 de vuelta con tornillo de sujeción.
- Florón en acero inoxidable.
- Eje de latón.

GRIFO LAVADORA LARGO

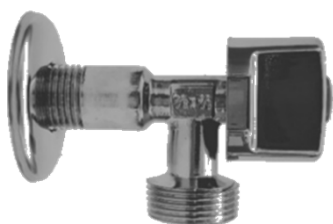

Código	Medida	Caja	Código Barras	€ / Ud.
11006	M 1/2" x M 3/4"	50	8435195820027	4,35

- PN 16.
- Latón EN 12165 cromado.
- Temperatura máxima 90°C.
- Mando ABS 1/4 de vuelta con tornillo de sujeción.
- Florón en acero inoxidable.
- Eje de latón.

GRIFO LAVADORA CORTO



Código	Medida	Caja	Código Barras	€ / Ud.
11510	M 1/2" x M 3/4"	100	8435195820034	3,58

- PN 16.
- Latón EN 12165 cromado.
- Temperatura máxima 90°C.
- Mando ABS 1/4 de vuelta con tornillo de sujeción.
- Florón en acero inoxidable.
- Eje de latón.

VÁLVULAS DE LATÓN



GRIFO LAVADORA CON VÁLVULA DE REGULACIÓN



Código	Medida	Caja	Código Barras	€ / Ud.
11508	M 1/2" x M 3/4" x M 3/8"	50	8435195834048	9,05
11509	M 1/2" x M 1/2" x M 3/8"	50	8435195834055	10,24

- PN 16.
- Latón EN 12165 cromado.
- Temperatura máxima 90°C.
- Mandos ABS 1/4 de vuelta con tornillos de sujeción.
- Florón en acero inoxidable.
- Eje de latón.

VÁLVULA MIXTA LAVADORA - LAVABO



Código	Medida	Caja	Código Barras	€ / Ud.
25517	M 1/2" x M 3/8" x M 3/4"	50	8435195801927	9,59

- PN 16.
- Latón EN 12165 cromado.
- Temperatura máxima 90°C.
- Mando ABS.
- Florón en acero inoxidable.

VÁLVULAS DE LATÓN



CODO LATÓN PULIDO Y CROMADO



Código	Medida	Caja	Código Barras	€ / Ud.
12130	M 1/2" x M 3/8"	50	8435195821505	2,90
12131	M 1/2" x M 1/2"	50	8435195821512	3,79

- PN 10.
- Latón EN 12165 cromado y pulido.
- Temperatura máxima 90°C.
- Florón en acero inoxidable.

CODO MONOBLOC CROMADO

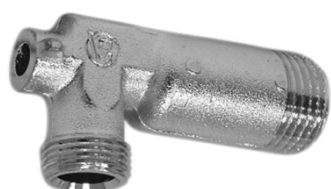

Código	Medida	Caja	Código Barras	€ / Ud.
64501	M 1/2" x M 3/8"	50	8435195810127	1,58

- PN 10.
- Latón EN 12165 cromado.
- Temperatura máxima 90°C.

FLORÓN ACERO INOXIDABLE



Código	Medida	Caja	Código Barras	€ / Ud.
63501	3/8" Sin garras	100	8435195809671	0,21
63502	1/2" x 55 Sin garras	100	8435195809688	0,15
63504	1/2" x 55 Con garras	100	8435195809701	0,18
63506	1/2" x 65 Sin garras	100	8435195825510	0,47
63509	1/2" x 65 Con garras	100	8435195825527	0,29
63508	3/4" x 65 Sin garras	100	8435195841473	0,47

TUERCA ENLACE

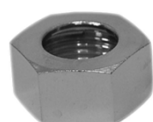

Su color

Código	Medida	Caja	Código Barras	€ / Ud.
71001	3/8" x 10 Ø	100	8435195811629	0,47
71002	1/2" x 10 Ø	100	8435195811636	0,59
71003	1/2" x 12 Ø	100	8435195811643	0,64



Cromo

71004	3/8" x 10 Ø	100	8435195811650	0,56
71005	1/2" x 10 Ø	100	8435195811667	0,65
71006	1/2" x 12 Ø	100	8435195811674	0,70

BICONO DE CAUCHO



Código	Medida	Caja	Código Barras	€ / Ud.
74002	3/8" x 10 Ø	100	8435195812206	0,087
74003	1/2" x 12 Ø	100	8435195812213	0,087
74004	1/2" x 10 Ø	100	8435195812220	0,087



GRIFERÍA TEMPORIZADA

Grifos lavabo		16
Grifos mural		17
Grifos fuente		17
Grifos ducha		19
Grifos urinario		20
Fluxómetros y tubos		20
Rejilla urinario		21

GRIFERÍA TEMPORIZADA



GRIFO LAVABO



Código	Medida	Caja	Código Barras	€ / Ud.
1001	1/2"	2	8435195817201	41,95

- Tiempo de apertura estándar de 8 a 12 segundos.
- Cuerpo fabricado en latón según EN1982 y cromado.
- Atomizador de latón.

	Código	Descripción	Código Barras	€ / Ud.
Recambio	1012	Montura + Pulsador	8435195817249	16,40

GRIFO LAVABO MINIMALISTA



Código	Medida	Caja	Código Barras	€ / Ud.
1002	1/2"	2	8435195821529	41,95

- Tiempo de apertura estándar de 8 a 12 segundos.
- Cuerpo fabricado en latón según EN1982 y cromado.
- Atomizador de latón.

GRIFO LAVABO REPISA



Código	Medida	Caja	Código Barras	€ / Ud.
1005	1/2"	2	8435195817225	72,56

- Tiempo de apertura estándar de 8 a 12 segundos.
- Cuerpo fabricado en latón según EN1982 y cromado.
- Atomizador de latón.

	Código	Descripción	Código Barras	€ / Ud.
Recambio	1017	Montura + Pulsador	8435195834062	34,70

GRIFO LAVABO MEZCLADOR



Código	Medida	Caja	Código Barras	€ / Ud.
1009	1/2"	2	8435195828283	121,62

- Tiempo de apertura estándar de 8 a 12 segundos.
- Dotado de válvula antirretorno
- Cuerpo fabricado en latón según EN1982 y cromado.
- Atomizador de latón.

	Código	Descripción	Código Barras	€ / Ud.
Recambio	1017	Montura + Pulsador	8435195834062	34,70

GRIFERÍA TEMPORIZADA



GRIFO MURAL



Código	Medida	Caja	Código Barras	€ / Ud.
1003	1/2"	2	8435195817218	55,94

- Tiempo de apertura estándar de 8 a 12 segundos.
- Cuerpo fabricado en latón según EN 1982.
- Cromado.

	Código	Descripción	Código Barras	€ / Ud.
Recambio	1017	Montura + Pulsador	8435195834062	34,70

GRIFO MURAL



Código	Medida	Caja	Código Barras	€ / Ud.
1031	1/2"	2	8435195817294	25,55

- Tiempo de apertura estándar de 8 a 12 segundos.
- Cuerpo fabricado en latón según EN 1982.
- Cromado.

	Código	Descripción	Código Barras	€ / Ud.
Recambio	1012	Montura + Pulsador	8435195817249	16,40

GRIFO FUENTE VERTICAL



Código	Medida	Caja	Código Barras	€ / Ud.
1033	3/8"	2	8435195817300	52,60

- Tiempo de apertura estándar de 8 a 12 segundos.
- Cuerpo fabricado en latón según EN 1982.
- Cromado.

	Código	Descripción	Código Barras	€ / Ud.
Recambio	1014	Montura + Pulsador	8435195817263	17,84

GRIFO FUENTE CAÑO ALTO



Código	Medida	Caja	Código Barras	€ / Ud.
1034	3/8"	2	8435195817317	55,07

- Tiempo de apertura estándar de 8 a 12 segundos.
- Cuerpo fabricado en latón según EN 1982.
- Cromado.

	Código	Descripción	Código Barras	€ / Ud.
Recambio	1036	Montura + Pulsador	8435195834079	27,17

GRIFERÍA TEMPORIZADA



GRIFO FUENTE PÚBLICA S/COLOR



Código	Medida	Caja	Código Barras	€ / Ud.
1035	1/2"	1	8435195828290	41,08
1037	3/4"	1	8435195828306	42,33
1038	1"	1	8435195828313	59,26

- Cuerpo fabricado en latón según EN 1982.
- Su color.

GRIFO FUENTE PÚBLICA CROMO



Código	Medida	Caja	Código Barras	€ / Ud.
1047	1/2"	1	8435195828320	60,48
1048	3/4"	1	8435195828337	66,08
1049	1"	1	8435195828344	98,21

- Cuerpo fabricado en latón según EN 1982.
- Cromado.

GRIFO FUENTE PÚBLICA PULSADOR FRONTAL S/COLOR



Código	Medida	Caja	Código Barras	€ / Ud.
1126	1/2"	1	8435195834093	43,78

- Cuerpo fabricado en latón según EN 1982.
- Su color.

• **Modelo cierre soleta página 128**

GRIFERÍA TEMPORIZADA



GRIFO DUCHA / URINARIO EMPOTRAR



Código	Medida	Caja	Código Barras	€ / Ud.
1020	1/2"	2	8435195817270	69,47

- Tiempo de apertura estandar ducha: 15/25"
- Tiempo de apertura estandar urinario: 4/6"
- Cuerpo fabricado en latón según EN 1982.

GRIFO DUCHA / URINARIO VISTO



Código	Medida	Caja	Código Barras	€ / Ud.
1021	1/2"	2	8435195817287	44,76

- Tiempo de apertura pre regulada.
- Tiempo de apertura estandar urinario: 4/6"
- Cuerpo fabricado en latón según EN 1982.
- Cromado.

GRIFO DUCHA MEZCLADOR EMPOTRAR



Código	Medida	Caja	Código Barras	€ / Ud.
1022	1/2"	2	8435195828139	134,36

- Tiempo de apertura estandar: 15/25"
- Dotada de válvula antirretorno.
- Cuerpo fabricado en latón según EN 1982.

GRIFO DUCHA MEZCLADOR VISTO



Código	Medida	Caja	Código Barras	€ / Ud.
1023	1/2"	2	8435195828146	142,09

- Tiempo de apertura estandar: 15/25"
- Dotada de válvula antirretorno.
- Cuerpo fabricado en latón según EN 1982.
- Cromado.

GRIFO PREMEZCLADOR



Código	Medida	Caja	Código Barras	€ / Ud.
1057	1/2"	2	8435195817423	52,41

- Tiempo de apertura estándar: 12/16"
- Dotada de válvula antirretorno.
- Cuerpo fabricado en latón según EN 1982.

GRIFERÍA TEMPORIZADA



GRIFO URINARIO



Código	Medida	Caja	Código Barras	€ / Ud.
1010	1/2"	2	8435195817232	40,95

- Tiempo de apertura estándar de 8 a 12 segundos.
- Cuerpo fabricado en latón según EN 1982.
- Con accesorio para urinario recto.
- Cromado.

	Código	Descripción	Código Barras	€ / Ud.
Recambio	1013	Montura + Pulsador	8435195817256	17,15
	1011	Tubo recto + florón	8435195815528	9,89
	1024	Tubo curvo 15,5 cm + florón + tuerca	8435195834109	11,97

GRIFO URINARIO MINIMALISTA



Código	Medida	Caja	Código Barras	€ / Ud.
1050	1/2" Cuadrado	2	8435195821536	37,76
1016	1/2" Cilíndrico	2	8435195825572	49,80

- Tiempo de apertura estándar de 8 a 12 segundos.
- Cuerpo fabricado en latón según EN 1982.
- Tubo de salida ajustable.
- Cromado.

FLUXÓMETRO EMPOTRAR TEMPORIZADO



Código	Medida	Caja	Código Barras	€ / Ud.
1064	3/4"	2	8435195817430	68,20

- Tiempo de apertura estándar de 5 a 8 segundos.
- Cuerpo fabricado en latón según EN 1982.
- Cromado.

	Código	Descripción	Código Barras	€ / Ud.
Recambio	1004	Montura + Pulsador	8435195833997	38,68

FLUXÓMETRO VISTO TEMPORIZADO



Código	Medida	Caja	Código Barras	€ / Ud.
1065	3/4"	2	8435195817447	86,78
1075	1"	1	8435195817454	74,75

- Tiempo de apertura estándar de 5 a 8 segundos.
- Cuerpo fabricado en latón según EN 1982.
- Cromado.

GRIFERÍA TEMPORIZADA



TUBO CROMADO EXTENSIBLE

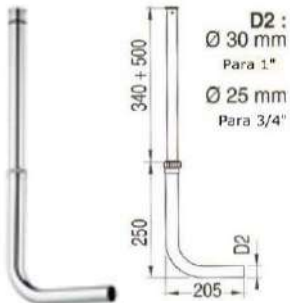

Código	Medida	Caja	Código Barras	€ / Ud.
1066	Ø 25 x 3/4"	2	8435195817461	35,85
1067	Ø 32 x 1"	2	8435195817478	35,85

- Accesorio para fluxómetro empotrado y visto.
- Cuerpo fabricado en latón según EN 12165.
- Cromado.

FILTRO REJILLA URINARIO

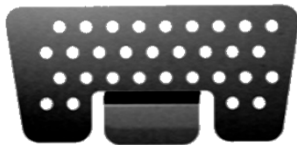

Código	Medida	Caja	Código Barras	€ / Ud.
85121	Única	10	8435195823684	1,19



GRIFOS DE PEDAL

Grifos un pedal		24
Grifos dos pedales		25
Caños fijos y giratorios		25

GRIFOS DE PEDAL



GRIFO PEDAL UN AGUA



Código	Medida	Caja	Código Barras	€ / Ud.
1055	1/2"	2	8435195817416	71,98

- Cuerpo latón cromado.
- Regulación de caudal incorporado.
- Agua fría con caudal constante.
- Sujeción al suelo y pared.

GRIFO PEDAL UN AGUA TEMPORIZADO "LUX"



Código	Medida	Caja	Código Barras	€ / Ud.
1082	1/2"	2	8435195828153	133,18

- Cuerpo latón cromado.
- Regulación de caudal incorporado.
- Agua fría con caudal constante.
- Sujeción al suelo y pared.
- Modelo LUX.

GRIFO PEDAL MEZCLADOR



Código	Medida	Caja	Código Barras	€ / Ud.
1053	1/2"	2	8435195817386	92,89

- Cuerpo latón cromado.
- Regulación de caudal incorporado.
- Agua fría y progresivamente agua mezclada.
- Sujeción al suelo y pared.

GRIFOS DE PEDAL Y ACCESORIOS



GRIFO DOS PEDALES



Código	Medida	Caja	Código Barras	€ / Ud.
1056	1/2"	2	8435195817409	179,25

- Cuerpo latón cromado.
- Regulación de caudal incorporado.
- Agua fría y caliente. Pulsando ambos pedales: agua mezclada.
- Sujeción al suelo.

GRIFO DOS PEDALES



Código	Medida	Caja	Código Barras	€ / Ud.
1083	1/2"	2	8435195828160	198,35

- Cuerpo latón cromado.
- Regulación de caudal incorporado.
- Agua fría y caliente. Pulsando ambos pedales: agua mezclada.
- Sujeción al suelo y pared.
- Modelo LUX.

CAÑO FIJO



Código	Medida	Caja	Código Barras	€ / Ud.
1040	1/2"	2	8435195817324	41,82

- Caño fundido a pared. • Con atomizador.



Código	Medida	Caja	Código Barras	€ / Ud.
1041	1/2"	2	8435195817331	52,91

- Caño fundido a encimera. • Con atomizador.

Código	Medida	Caja	Código Barras	€ / Ud.
1054	1/2"	2	8435195821550	38,25

- Caño fundido a encimera. • Con atomizador.

CAÑO GIRATORIO



Código	Medida	Caja	Código Barras	€ / Ud.
1042	1/2"	2	8435195817348	77,65

- Caño fundido a encimera. • Con atomizador.

Código	Medida	Caja	Código Barras	€ / Ud.
1043	1/2"	2	8435195817355	45,51

- Caño tubo a encimera 200 mm. • Con atomizador.

Código	Medida	Caja	Código Barras	€ / Ud.
1044	1/2"	2	8435195827910	44,82



- Caño a pared bajo. • Con atomizador.

Código	Medida	Caja	Código Barras	€ / Ud.
1045	1/2"	2	8435195827996	41,58

- Caño a pared alto. • Con atomizador



GRIFERÍA MEDICAL

Grifos mural		28
Grifos lavabo		28
Grifos fregadero		29

GRIFERÍA MEDICAL



GRIFO MURAL MEDICAL CAÑO BAJO



Código	Medida	Caja	Código Barras	€ / Ud.
25551	1/2"	1	8435195825268	108,76

- Caño bajo giratorio tubo de latón.
- Cuerpo fabricado en latón según EN 1982.
- Cromado.
- Entrada M 1/2.

GRIFO MURAL MEDICAL 1/2"



Código	Medida	Caja	Código Barras	€ / Ud.
25555	1/2"	1	8435195825305	47,52

- Cuerpo fabricado en latón según EN 1982.
- Cromado.
- Entrada M 1/2.

GRIFO MURAL MEDICAL ITÁLICO

	Código	Medida	Caja	Código Barras	€ / Ud.
Corto	25505	1/2"	1	8435195801873	20,51
Largo	25506	1/2"	1	8435195801880	21,82



- Cuerpo fabricado en latón según EN 1982.
- Cromado.
- Entrada M 1/2.

	Código	Descripción	Código Barras	€ / Ud.
Recambio	19054	Palanca medical	8435195834925	9,47

GRIFO LAVABO MEDICAL



Código	Medida	Caja	Código Barras	€ / Ud.
25556	1/2"	1	8435195825312	36,80

- Cuerpo fabricado en latón según EN 1982.
- Cromado.
- Atomizador de latón

GRIFERÍA MEDICAL



MONOMANDO FREGADERO MEDICAL



Código	Medida	Caja	Código Barras	€ / Ud.
25552	-	1	8435195825275	49,76

- Caño alto orientable tubo de latón.
- Cuerpo latón pulido y cromado.
- Cartucho cerámico de 40 mm.
- Conexiones Aenor H3/8*35 cm.
- Atomizador de latón M 24/100.

	Código	Descripción	Código Barras	€ / Ud.
Recambio	1110	Cartucho 40 mm.	8435195821116	3,96

MONOMANDO FREGADERO MURAL MEDICAL



Código	Medida	Caja	Código Barras	€ / Ud.
25553	-	1	8435195825282	89,20

- Caño bajo orientable tubo de latón.
- Cuerpo latón pulido y cromado.
- Cartucho cerámico de 40 mm.
- Excéntricas de latón niquelado.
- Atomizador de latón M 24/100.

	Código	Descripción	Código Barras	€ / Ud.
Recambio	1110	Cartucho 40 mm.	8435195821116	3,96

MONOMANDO LAVABO MEDICAL



Código	Medida	Caja	Código Barras	€ / Ud.
25557	-	1	8435195825329	66,78

- Cuerpo fabricado en latón según EN 1982.
- Cromado.
- Cartucho cerámico de 40 mm.
- Conexiones Aenor 10/100*3/8*35 cm.
- Atomizador de latón

	Código	Descripción	Código Barras	€ / Ud.
Recambio	1110	Cartucho 40 mm.	8435195821116	3,96

PALANCA GERONTOLÓGICA - MEDICAL CROMO



Código	Medida	Caja	Código Barras	€ / Ud.
1105	-	1	8435195834512	37,46



GRIFERÍA SERIE

Grifería serie CATI		32
Grifería serie MINIMALISTA		33
Grifería serie ESFERA		34
Grifería serie NICE		35
Grifería TERMOSTÁTICA		36

GRIFERÍA SERIE CATI



MONOMANDO LAVABO CATI



Código	Medida	Caja	Código Barras	€ / Ud.
1170	-	1	8435195815535	40,98

- Cuerpo latón pulido y cromado.
- Cartucho cerámico de 40 mm.
- Conexiones Aenor 10/100*3/8*35 cm.
- Atomizador de latón M 24/100.

	Código	Descripción	Código Barras	€ / Ud.
Recambio	1110	Cartucho 40 mm.	8435195821116	3,96

MONOMANDO BIDET CATI

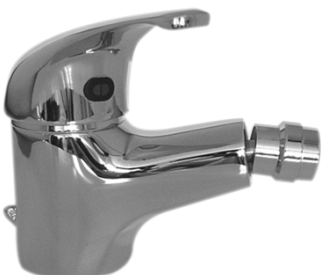

Código	Medida	Caja	Código Barras	€ / Ud.
1171	-	1	8435195815542	40,62

- Cuerpo latón pulido y cromado.
- Cartucho cerámico de 40 mm.
- Conexiones Aenor 10/100*3/8*35 cm.
- Atomizador de latón M 24/100.

	Código	Descripción	Código Barras	€ / Ud.
Recambio	1110	Cartucho 40 mm.	8435195821116	3,96

MONOMANDO DUCHA CATI



Código	Medida	Caja	Código Barras	€ / Ud.
1172	-	1	8435195815559	49,98

- Cuerpo latón pulido y cromado.
- Cartucho cerámico de 40 mm.
- Excéntricas de latón niquelado.
- Incluye mango de ducha, soporte y flexo.

	Código	Descripción	Código Barras	€ / Ud.
Recambio	1110	Cartucho 40 mm.	8435195821116	3,96

MONOMANDO BAÑO CATI



Código	Medida	Caja	Código Barras	€ / Ud.
1173	-	1	8435195815566	59,40

- Cuerpo latón pulido y cromado.
- Cartucho cerámico de 40 mm.
- Excéntricas de latón niquelado.
- Incluye mango de ducha, soporte y flexo.
- Atomizador de latón M 24/100.

	Código	Descripción	Código Barras	€ / Ud.
Recambio	1110	Cartucho 40 mm.	8435195821116	3,96

GRIFERÍA SERIE MINIMALISTA



MONOMANDO LAVABO MINIMALISTA



Código	Medida	Caja	Código Barras	€ / Ud.
1180	-	1	8435195815580	51,10

- Cuerpo latón pulido y cromado.
- Cartucho cerámico de 40 mm.
- Conexiones Aenor 10/100*3/8*35 cm.
- Atomizador de latón M 24/100.

	Código	Descripción	Código Barras	€ / Ud.
Recambio	1110	Cartucho 40 mm.	8435195821116	3,96

MONOMANDO BIDET MINIMALISTA



Código	Medida	Caja	Código Barras	€ / Ud.
1181	-	1	8435195815597	37,80

- Cuerpo latón pulido y cromado.
- Cartucho cerámico de 40 mm.
- Conexiones Aenor 10/100*3/8*35 cm.
- Atomizador de latón M 24/100.

	Código	Descripción	Código Barras	€ / Ud.
Recambio	1110	Cartucho 40 mm.	8435195821116	3,96

MONOMANDO DUCHA MINIMALISTA



Código	Medida	Caja	Código Barras	€ / Ud.
1183	-	1	8435195815610	85,67

- Cuerpo latón pulido y cromado.
- Cartucho cerámico de 40 mm.
- Excéntricas de latón niquelado.
- Incluye mango de ducha, soporte y flexo.

	Código	Descripción	Código Barras	€ / Ud.
Recambio	1110	Cartucho 40 mm.	8435195821116	3,96

MONOMANDO BAÑO MINIMALISTA



Código	Medida	Caja	Código Barras	€ / Ud.
1182	-	1	8435195815603	85,67

- Cuerpo latón pulido y cromado.
- Cartucho cerámico de 40 mm.
- Excéntricas de latón niquelado.
- Incluye mango de ducha, soporte y flexo.
- Atomizador de latón M 24/100.

	Código	Descripción	Código Barras	€ / Ud.
Recambio	1110	Cartucho 40 mm.	8435195821116	3,96

GRIFERÍA SERIE ESFERA



MONOBLOC LAVABO ESFERA



Código	Medida	Caja	Código Barras	€ / Ud.
1084	-	1	8435195817553	66,69

- Cuerpo latón pulido y cromado.
- Monturas cerámica de media vuelta.
- Conexiones Aenor 10/100*3/8*35 cm.
- Atomizador de latón M 24/100.

	Código	Descripción	Código Barras	€ / Ud.
Recambio	1080	Montura cerámica 1/2"	8435195834116	7,57

MONOBLOC BIDET ESFERA



Código	Medida	Caja	Código Barras	€ / Ud.
1085	-	1	8435195817560	49,06

- Cuerpo latón pulido y cromado.
- Monturas cerámica de media vuelta.
- Conexiones Aenor 10/100*3/8*35 cm.
- Atomizador de latón M 24/100.

	Código	Descripción	Código Barras	€ / Ud.
Recambio	1080	Montura cerámica 1/2"	8435195834116	7,57

MONOBLOC DUCHA ESFERA



Código	Medida	Caja	Código Barras	€ / Ud.
1087	-	1	8435195817584	64,99

- Cuerpo latón pulido y cromado.
- Monturas cerámica de media vuelta.
- Excéntricas de latón niquelado.
- Incluye mango de ducha de latón cromado, soporte y flexo.

	Código	Descripción	Código Barras	€ / Ud.
Recambio	1080	Montura cerámica 1/2"	8435195834116	7,57

MONOBLOC BAÑO ESFERA



Código	Medida	Caja	Código Barras	€ / Ud.
1086	-	1	8435195817577	91,94

- Cuerpo latón pulido y cromado.
- Monturas cerámica de media vuelta.
- Excéntricas de latón niquelado.
- Incluye mango de ducha de latón cromado, soporte y flexo.

	Código	Descripción	Código Barras	€ / Ud.
Recambio	1080	Montura cerámica 1/2"	8435195834116	7,57

GRIFERÍA SERIE NICE



MONOMANDO LAVABO NICE



Código	Medida	Caja	Código Barras	€ / Ud.
1201	-	1	8435195847758	38,00

- Cuerpo latón pulido y cromado.
- Cartucho cerámico de 40 mm.
- Conexiones Aenor 10/100*3/8*35 cm.
- Atomizador antivandálico de latón M 24/100.

MONOMANDO LAVABO EMPOTRAR NICE



Código	Medida	Caja	Código Barras	€ / Ud.
1202	-	1	8435195847765	99,00

- Cuerpo latón pulido y cromado.
- Cartucho cerámico de 40 mm.
- Atomizador antivandálico de latón M 24/100.

MONOMANDO BIDET NICE



Código	Medida	Caja	Código Barras	€ / Ud.
1203	-	1	8435195847772	36,50

- Cuerpo latón pulido y cromado.
- Cartucho cerámico de 40 mm.
- Conexiones Aenor 10/100*3/8*35 cm.
- Atomizador con rótula de latón M 24/100.

MONOMANDO DUCHA EMPOTRAR 1 VÍA NICE



Código	Medida	Caja	Código Barras	€ / Ud.
1204	H 1/2"	1	8435195847789	50,00

- Mezclador agua fría/caliente.
- Cartucho cerámico de 40 mm.

MONOMANDO DUCHA EMPOTRAR 2 VÍAS NICE



Código	Medida	Caja	Código Barras	€ / Ud.
1205	H 1/2"	1	8435195847796	76,50

- Mezclador agua fría/caliente.
- Con distribuidor: tres posiciones.

GRIFERÍA TERMOSTÁTICA



TERMOSTÁTICA DUCHA



Código	Medida	Caja	Código Barras	€ / Ud.
1187	-	1	8435195817607	99,27

- Cuerpo latón pulido y cromado.
- Cartucho termostático de latón.
- Regulación automática de temperatura a 38°C
- Incluye mango de ducha, soporte y flexo.

	Código	Descripción	Código Barras	€ / Ud.
Recambio	11111	Cartucho termostático	8435195834123	35,14

TERMOSTÁTICA BAÑO



Código	Medida	Caja	Código Barras	€ / Ud.
1189	-	1	8435195817621	114,96

- Cuerpo latón pulido y cromado.
- Cartucho termostático de latón.
- Regulación automática de temperatura a 38°C
- Incluye mango de ducha, soporte y flexo.

	Código	Descripción	Código Barras	€ / Ud.
Recambio	11111	Cartucho termostático	8435195834123	35,14



GRIFERÍA HIGIÉNICA WC/BIDET

Grifo higiénico y mangos



38

GRIFERÍA HIGIÉNICA WC/BIDET



GRIFO HIGIÉNICO MEZCLADOR WC/BIDET MANGO ABS



Código	Medida	Caja	Código Barras	€ / Ud.
1301	-	1	8435195847802	54,60

- Agua fría y caliente.
- Flexo WC/Bidet PVC 1,2m.
- Mango WC/Bidet ABS.

GRIFO HIGIÉNICO MEZCLADOR WC/BIDET MANGO LATÓN



Código	Medida	Caja	Código Barras	€ / Ud.
1302	-	1	8435195847819	68,24

- Agua fría y caliente.
- Flexo WC/Bidet PVC 1,2m.
- Mango WC/Bidet latón.

MANGO ABS GRIFO HIGIÉNICO WC/BIDET



Código	Medida	Caja	Código Barras	€ / Ud.
1303	-	1	8435195847826	4,40

MANGO LATÓN GRIFO HIGIÉNICO WC/BIDET



Código	Medida	Caja	Código Barras	€ / Ud.
1304	-	1	8435195847833	21,50



COLUMNAS DE DUCHA

Columnas de ducha



40

COLUMNAS DE DUCHA



COLUMNA TELESCÓPICA DUCHA



Código	Medida	Caja	Código Barras	€ / Ud.
78301	-	1	8435195828191	198,25

- Válida para bañera y ducha.
- Compatible con cualquier grifería.
- Extensible: 800 a 1350 mm.
- Tubo y soporte a pared de latón cromado.
- Rociador redondo de 20 cm.
- Flexo de acero reforzado.
- Soporte mango ducha deslizante.
- Incluye mango de ducha.

COLUMNA TELESCÓPICA DUCHA CON TERMOSTÁTICA



Código	Medida	Caja	Código Barras	€ / Ud.
78302	-	1	8435195828207	270,85

- Grifería termostática con mando y distribuidor.
- Extensible: 800 a 1350 mm.
- Tubo y soporte a pared de latón cromado.
- Rociador redondo de 20 cm.
- Flexo de acero reforzado.
- Soporte mango ducha deslizante.
- Incluye mango de ducha.

COLUMNA TELESCÓPICA DUCHA CON MONOMANDO

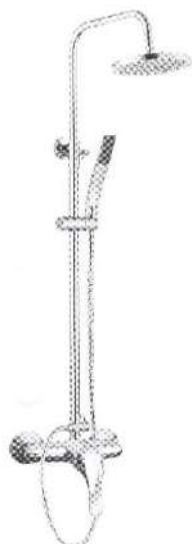



Código	Medida	Caja	Código Barras	€ / Ud.
78303	-	1	8435195828214	229,98

- Grifería monomando.
- Extensible: 800 a 1350 mm.
- Tubo y soporte a pared de latón cromado.
- Rociador redondo de 20 cm.
- Flexo de acero reforzado.
- Soporte mango ducha deslizante.
- Incluye mango de ducha.



GRIFERÍA DE FREGADERO

Monomandos		42
Baterías		45
Monoblocs		46

GRIFERÍA DE FREGADERO

Monomandos



MONOMANDO FREGADERO CAÑO HORIZONTAL



Código	Medida	Caja	Código Barras	€ / Ud.
1174	-	1	8435195821475	39,70

- Caño tubo de latón conformado.
- Cuerpo latón pulido y cromado.
- Cartucho cerámico de 40 mm.
- Conexiones Aenor 10/100*3/8*35 cm.
- Atomizador de latón M 24/100.

	Código	Descripción	Código Barras	€ / Ud.
Recambio	1110	Cartucho 40 mm.	8435195821116	3,96

MONOMANDO FREGADERO VERTICAL CAÑO TUBO



Código	Medida	Caja	Código Barras	€ / Ud.
1175	-	1	8435195815573	50,95

- Caño tubo de latón conformado.
- Cuerpo latón pulido y cromado.
- Cartucho cerámico de 40 mm.
- Conexiones Aenor 10/100*3/8*35 cm.
- Atomizador de latón M 24/100.

	Código	Descripción	Código Barras	€ / Ud.
Recambio	1110	Cartucho 40 mm.	8435195821116	3,96

MONOMANDO FREGADERO VERTICAL CAÑO FUNDIDO



Código	Medida	Caja	Código Barras	€ / Ud.
1076	-	1	8435195825602	82,95

- Caño fundido de latón.
- Cuerpo latón pulido y cromado.
- Cartucho cerámico de 40 mm.
- Conexiones Aenor 10/100*3/8*35 cm.
- Atomizador de latón M 24/100.

	Código	Descripción	Código Barras	€ / Ud.
Recambio	1110	Cartucho 40 mm.	8435195821116	3,96

MONOMANDO FREGADERO VERTICAL CAÑO CISNE



Código	Medida	Caja	Código Barras	€ / Ud.
1194	-	1	8435195825596	58,20

- Caño tubo de latón Ø 24 mm.
- Cuerpo latón pulido y cromado.
- Cartucho cerámico de 40 mm.
- Conexiones Aenor 10/100*3/8*35 cm.
- Atomizador de latón H 22/100.

	Código	Descripción	Código Barras	€ / Ud.
Recambio	1110	Cartucho 40 mm.	8435195821116	3,96

GRIFERÍA DE FREGADERO

Monomandos



MONOMANDO FREGADERO EXTRAÍBLE CAÑO BAJO



Código	Medida	Caja	Código Barras	€ / Ud.
1177	-	1	8435195825619	67,72

- Cuerpo latón pulido y cromado.
- Cartucho cerámico de 40 mm.
- Conexiones Aenor 10/100*3/8*35 cm.
- Mango de dos posiciones.

	Código	Descripción	Código Barras	€ / Ud.
Recambio	1110	Cartucho 40 mm.	8435195821116	3,96
	78005	Mango extraíble	8435195825862	7,50

MONOMANDO FREGADERO EXTRAÍBLE CAÑO ALTO



Código	Medida	Caja	Código Barras	€ / Ud.
1196	-	1	8435195820485	93,80

- Cuerpo latón pulido y cromado.
- Cartucho cerámico de 40 mm.
- Conexiones Aenor 10/100*3/8*35 cm.
- Mango de dos posiciones.

	Código	Descripción	Código Barras	€ / Ud.
Recambio	1110	Cartucho 40 mm.	8435195821116	3,96
	78005	Mango extraíble	8435195825862	7,50

MONOMANDO FREGADERO OSMOSIS



Código	Medida	Caja	Código Barras	€ / Ud.
1179	-	1	8435195828351	123,43

- Caño tubo de latón.
- Cuerpo latón pulido y cromado.
- Cartucho cerámico de 35 mm.
- Conexiones Aenor 10/100*3/8*35 cm.
- Atomizador de latón M 24/100 para mezclador
- Atomizador de latón M 18/100 para osmotizador.

	Código	Descripción	Código Barras	€ / Ud.
Recambio	1112	Cartucho 35 mm.	8435195821130	3,96

MONOMANDO FREGADERO MINIMALISTA



Código	Medida	Caja	Código Barras	€ / Ud.
1184	-	1	8435195815627	46,30

- Caño tubo de latón Ø 24 mm.
- Cuerpo latón pulido y cromado.
- Cartucho cerámico de 40 mm.
- Conexiones Aenor 10/100*3/8*35 cm.

GRIFERÍA DE FREGADERO

Monomandos



MONOMANDO FREGADERO MURAL CAÑO ALTO TUBO



Código	Medida	Caja	Código Barras	€ / Ud.
1176	-	1	8435195825626	65,40

- Caño tubo de latón conformado.
- Cuerpo latón pulido y cromado.
- Cartucho cerámico de 40 mm.
- Atomizador de latón M 24/100.

	Código	Descripción	Código Barras	€ / Ud.
Recambio	1110	Cartucho 40 mm.	8435195821116	3,96

MONOMANDO FREGADERO MURAL CAÑO ALTO FUNDIDO



Código	Medida	Caja	Código Barras	€ / Ud.
1102	-	1	8435195834130	85,24

- Caño fundido de latón.
- Cuerpo latón pulido y cromado.
- Cartucho cerámico de 40 mm.
- Atomizador de latón M 24/100.

	Código	Descripción	Código Barras	€ / Ud.
Recambio	1110	Cartucho 40 mm.	8435195821116	3,96

MONOMANDO FREGADERO MURAL CAÑO BAJO TUBO



Código	Medida	Caja	Código Barras	€ / Ud.
1178	-	1	8435195825633	57,60

- Cuerpo latón pulido y cromado.
- Cartucho cerámico de 40 mm.
- Atomizador de latón M 24/100.

	Código	Descripción	Código Barras	€ / Ud.
Recambio	1110	Cartucho 40 mm.	8435195821116	3,96

GRIFERÍA DE FREGADERO

Baterías



BATERÍA FREGADERO CAÑO BAJO



Código	Medida	Caja	Código Barras	€ / Ud.
99071	11 cm.	1	8435195825640	43,00
99072	16 cm.	1	8435195825657	45,00

- Caño giratorio Ø 18 mm. Y longitud 22 cm. con filtro atomizador.
- Monturas cierre cerámico.
- Excéntricas de latón niquelado.

	Código	Descripción	Código Barras	€ / Ud.
Recambio	1135	Montura cerámica	8435195832228	3,55
	78211	Caño bajo	8435195832266	5,45
	19045	Volante metálico, tapa e índice	8435195832235	4,45

BATERÍA FREGADERO CAÑO ALTO



Código	Medida	Caja	Código Barras	€ / Ud.
99090	11 cm.	1	8435195817652	43,00
99089	16 cm.	1	8435195817669	45,00

- Caño giratorio Ø 18 mm. Y longitud 21 cm. con filtro atomizador.
- Monturas cierre cerámico.
- Excéntricas de latón niquelado.

	Código	Descripción	Código Barras	€ / Ud.
Recambio	1135	Montura cerámica	8435195832228	3,55
	78210	Caño alto	8435195832259	4,98
	19045	Volante metálico, tapa e índice	8435195832235	4,45

BATERÍA FREGADERO CAÑO ALTO MONTURA SOLETA



Código	Medida	Caja	Código Barras	€ / Ud.
99073	11 cm.	1	8435195828368	43,00
99074	16 cm.	1	8435195828375	45,00

- Caño giratorio Ø 18 mm. Y longitud 22 cm. con filtro atomizador.
- Monturas cierre soleta.
- Excéntricas de latón niquelado.

	Código	Descripción	Código Barras	€ / Ud.
Recambio	78210	Caño alto	8435195832259	4,98
	19045	Volante metálico, tapa e índice	8435195832235	4,45

BATERÍA FREGADERO CAÑO CORTO



Código	Medida	Caja	Código Barras	€ / Ud.
99097	11 cm.	1	8435195817676	41,00
99098	16 cm.	1	8435195817683	45,00

- Caño giratorio Ø 18 mm. Y longitud 16 cm. con filtro atomizador.
- Monturas cierre cerámico.
- Excéntricas de latón niquelado.

	Código	Descripción	Código Barras	€ / Ud.
Recambio	1135	Montura cerámica	8435195832228	3,55
	78204	Caño corto	8435195832242	7,20
	19045	Volante metálico, tapa e índice	8435195832235	4,45

GRIFERÍA DE FREGADERO

Monoblocs



MONOBLOC FREGADERO CAÑO TUBO



Código	Medida	Caja	Código Barras	€ / Ud.
1096	-	1	8435195817690	45,62

- Caño tubo de latón Ø 24 mm.
- Monturas cerámicas de media vuelta.
- Conexiones Aenor 10/100*3/8*35 cm.

	Código	Descripción	Código Barras	€ / Ud.
Recambio	1135	Montura cerámica	8435195832228	3,55
	19045	Volante metálico, tapa e índice	8435195832235	4,45



GRIFERÍA DE UN AGUA

Monomandos		48
Baterías		50
Office		51

GRIFERÍA DE UN AGUA

Monomandos



MONOMANDO MURAL UN AGUA CAÑO VERTICAL GIRATORIO



Código	Medida	Caja	Código Barras	€ / Ud.
1094	1/2"	1	8435195833973	26,68

- Caño tubo recto giratorio.
- Cartucho cerámico de 25 mm.
- Entrada de agua rosca gas macho 1/2"
- Atomizador de latón

	Código	Descripción	Código Barras	€ / Ud.
Recambio	1074	Cartucho 25 mm.	8435195827972	2,80
	78216	Caño vertical	8435195847857	12,00

MONOMANDO MURAL UN AGUA CAÑO VERTICAL GIRATORIO



Código	Medida	Caja	Código Barras	€ / Ud.
1107	1/2"	1	8435195834154	35,73

- Caño tubo recto giratorio.
- Cartucho cerámico de 25 mm.
- Entrada de agua rosca gas macho 1/2"
- Atomizador de latón H 22/100.

	Código	Descripción	Código Barras	€ / Ud.
Recambio	1074	Cartucho 25 mm.	8435195827972	2,80

MONOMANDO MURAL UN AGUA CAÑO HORIZONTAL GIRATORIO



Código	Medida	Caja	Código Barras	€ / Ud.
1099	1/2"	1	8435195817645	24,30

- Caño tubo recto giratorio de 22 cm.
- Cartucho cerámico de 25 mm.
- Entrada de agua rosca gas macho 1/2"
- Atomizador de latón H 22/100.

	Código	Descripción	Código Barras	€ / Ud.
Recambio	1074	Cartucho 25 mm.	8435195827972	2,80

MONOMANDO FREGADERO UN AGUA CAÑO VERTICAL CROMADO



Código	Medida	Caja	Código Barras	€ / Ud.
1103	1/2"	1	8435195834147	40,60

- Caño tubo recto giratorio.
- Cartucho cerámico de 25 mm.
- Entrada de agua rosca gas macho 1/2"
- Atomizador de latón H 22/100.

	Código	Descripción	Código Barras	€ / Ud.
Recambio	1074	Cartucho 25 mm.	8435195827972	2,80

GRIFERÍA DE UN AGUA

Monomandos



MONOMANDO MURAL LAVABO UN AGUA



Código	Medida	Caja	Código Barras	€ / Ud.
1072	1/2"	1	8435195828412	22,95

- Cartucho cerámico de 25 mm.
- Entrada de agua rosca gas macho 1/2"
- Atomizador de latón M 24/100.

	Código	Descripción	Código Barras	€ / Ud.
Recambio	1078	Cartucho 25 mm.	8435195834161	2,92

MONOMANDO LAVABO UN AGUA



Código	Medida	Caja	Código Barras	€ / Ud.
1071	1/2"	1	8435195828405	23,95

- Cartucho cerámico de 25 mm.
- Entrada de agua rosca gas macho 1/2"
- Atomizador de latón M 24/100.

	Código	Descripción	Código Barras	€ / Ud.
Recambio	1078	Cartucho 25 mm.	8435195834161	2,92

GRIFERÍA DE UN AGUA

Baterías



GRIFO MURAL UN AGUA CAÑO ALTO HORIZONTAL



Código	Medida	Caja	Código Barras	€ / Ud.
1069	1/2"	1	8435195817638	16,55

- Caño giratorio Ø 18 mm. Y longitud 22 cm. con filtro atomizador.
- Monturas cierre cerámico.
- Volante metálico con índice azul.
- Entrada M 1/2"

	Código	Descripción	Código Barras	€ / Ud.
Recambio	18510	Montura cerámica	8435195834727	2,30
	78213	Caño alto	8435195828399	4,98
	19045	Volante metálico, tapa e índice	8435195832235	4,45

GRIFO MURAL UN AGUA CAÑO BAJO HORIZONTAL

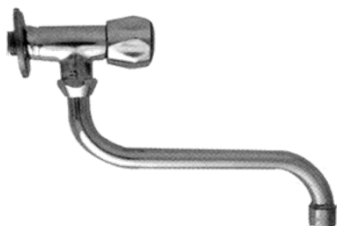

Código	Medida	Caja	Código Barras	€ / Ud.
1068	1/2"	1	8435195827927	16,55

- Caño giratorio Ø 18 mm. con filtro atomizador.
- Monturas cierre cerámico.
- Volante metálico con índice azul.
- Entrada M 1/2"

	Código	Descripción	Código Barras	€ / Ud.
Recambio	18510	Montura cerámica	8435195834727	2,30
	78211	Caño bajo	8435195832266	5,45
	19045	Volante metálico, tapa e índice	8435195832235	4,45

GRIFO UN AGUA CAÑO VERTICAL



Código	Medida	Caja	Código Barras	€ / Ud.
1098	1/2"	1	8435195817713	25,28

- Caño giratorio Ø 18 mm. y longitud 26 cm. con filtro atomizador.
- Monturas cierre cerámico.
- Volante metálico con índice azul.
- Entrada M 1/2"

	Código	Descripción	Código Barras	€ / Ud.
Recambio	1135	Montura cerámica	8435195832228	3,55
	78215	Caño vertical	8435195834178	14,40
	19045	Volante metálico, tapa e índice	8435195832235	4,45

GRIFERÍA DE UN AGUA

Office



PLACA ATORNILLAR CROMADA



Código	Medida	Caja	Código Barras	€ / Ud.
25519	M-H 1/2"	10	8435195801989	5,32
25521	H-H 1/2"	10	8435195802009	5,99

GRIFO LAVADORA SENCILLO



	Código	Medida	Caja	Código Barras	€ / Ud.
Soleta	25004	1/2" x 3/4"	10	8435195801774	6,75
Cerámico	25007	1/2" x 3/4"	10	8435195801781	10,50

- Entrada M 1/2" - Salida M 3/4"
- Volante metálico con índice azul.

	Código	Descripción	Código Barras	€ / Ud.
Recambio	1133	Montura soleta	8435195834239	2,95
	1134	Montura cerámica	8435195832211	2,95

GRIFO LAVADORA DOBLE TIPO "Y"



Código	Medida	Caja	Código Barras	€ / Ud.
25526	1/2" x 3/4" x 3/4"	10	8435195820331	11,81

- Entrada M 1/2" - 2 Salidas M 3/4"
- Volante metálico con índice azul.
- Montura cierre soleta.

	Código	Descripción	Código Barras	€ / Ud.
Recambio	1133	Montura soleta	8435195834239	2,95

GRIFO LAVADORA DOBLE



	Código	Medida	Caja	Código Barras	€ / Ud.
Soleta	25006	1/2" x 3/4"	10	8435195801804	14,60
Cerámico	25008	1/2" x 3/4"	10	8435195801811	13,98

- Entrada M 1/2" - Salida M 3/4"
- Volantes metálicos con índices azules.

	Código	Descripción	Código Barras	€ / Ud.
Recambio	1133	Montura soleta	8435195834239	2,95
	1134	Montura cerámica	8435195832211	2,95

GRIFO LAVAVAJILLAS DOBLE



	Código	Medida	Caja	Código Barras	€ / Ud.
Soleta	25010	1/2" x 3/4" x 3/4"	10	8435195801835	17,28
Cerámico	25011	1/2" x 3/4" x 3/4"	10	8435195801842	15,90

- Entrada M 1/2" - 2 Salidas M 3/4"
- Volantes metálicos con índices azules.

	Código	Descripción	Código Barras	€ / Ud.
Recambio	1133	Montura soleta	8435195834239	2,95
	1134	Montura cerámica	8435195832211	2,95

GRIFERÍA DE UN AGUA

Office



"Y" BIFURCACIÓN SALIDA DOBLE



Código	Medida	Caja	Código Barras	€ / Ud.
25509	3/4"	10	8435195834185	11,99

- Entrada H 3/4" - Salidas M 3/4" M 3/4"
- Fabricado en latón y cromado.

"Y" BIFURCACIÓN SALIDA DOBLE



Código	Medida	Caja	Código Barras	€ / Ud.
58535	3/4"	10	8435195834192	1,85

- Entrada H 3/4" - Salidas M 3/4" M 3/4"
- Fabricado en ABS.
- Tuerca de nylon.
- Junta de silicona.

CONJUNTO GRIFO ADAPTADOR

	Código	Medida	Caja	Código Barras	€ / Ud.
Conjunto	25507	3/4" x 3/4" x 3/4"	10	8435195801897	13,54
Adaptador	25508	3/4" x 3/4"	10	8435195801903	3,52



- Montura cierre soleta.
- Volante metálico con índice azul.

JUEGO GRIFOS DE BIDET



Código	Medida	Caja	Código Barras	€ / Ud.
24010	1/2"	2	8435195828238	53,60

- Juego de dos unidades.
- Montura cierre soleta.
- Entrada M 1/2"
- Volante metálico con un índice azul y un índice rojo.

JUEGO GRIFOS DE LAVABO



Código	Medida	Caja	Código Barras	€ / Ud.
24011	1/2"	2	8435195801613	27,29

- Juego de dos unidades.
- Montura cierre cerámico.
- Entrada M 1/2"
- Volante metálico con un índice azul y un índice rojo.

	Código	Descripción	Código Barras	€ / Ud.
Recambio	79005	Atomizador	8435195834208	0,77
	24008	Montura cerámica	8435195834218	3,68

GRIFERÍA DE UN AGUA

Office



GRIFO MURAL LAVABO CORTO



	Código	Medida	Caja	Código Barras	€ / Ud.
Soleta	24005	1/2 x 14 cm.	10	8435195801576	10,80
Cerámico	24003	1/2 x 14 cm.	10	8435195801552	9,00

- Entrada M 1/2".
- Salida con rompe-aguas.
- Volante metálico con índice azul.

	Código	Descripción	Código Barras	€ / Ud.
Recambio	1133	Montura soleta	8435195834239	2,95
	1134	Montura cerámica	8435195832211	2,95

GRIFO MURAL LAVABO LARGO



	Código	Medida	Caja	Código Barras	€ / Ud.
Soleta	24006	1/2 x 17 cm.	10	8435195801583	10,68
Cerámico	24004	1/2 x 17 cm.	10	8435195801569	12,41

- Entrada M 1/2".
- Salida con rompe-aguas.
- Volante metálico con índice azul.

	Código	Descripción	Código Barras	€ / Ud.
Recambio	1133	Montura soleta	8435195834239	2,95
	1134	Montura cerámica	8435195832211	2,95

GRIFO MURAL LAVABO



	Código	Medida	Caja	Código Barras	€ / Ud.
	24007	1/2"	10	8435195801590	11,27

- Montura cierre cerámico.
- Entrada M 1/2".
- Volante metálico con índice azul.

	Código	Descripción	Código Barras	€ / Ud.
Recambio	1134	Montura cerámica	8435195832211	2,95

GRIFO MURAL LAVABO ITÁLICO



	Código	Medida	Caja	Código Barras	€ / Ud.
Corto	25503	1/2" x 12 cm.	10	8435195801859	14,35
Largo	25504	1/2" x 16 cm.	10	8435195801866	14,70

- Montura cierre soleta 1/2 vuelta.
- Entrada M 1/2".

	Código	Descripción	Código Barras	€ / Ud.
Recambio	19020	Montura itálico	8435195834222	2,98



RECAMBIOS DE GRIFERÍA

Recambios de grifería



56

RECAMBIOS GRIFERÍA



PALANCAS



Código	Descripción	Código Barras	€ / Ud.
19054	Palanca medical corta	8435195834925	9,47
1105	Palanca medical larga	8435195834512	37,46

CARTUCHOS



Código	Descripción	Código Barras	€ / Ud.
1110	Cartucho 40 mm. Sin distribuidor	8435195821116	3,96
1111	Cartucho 40 mm. Con distribuidor	8435195821123	3,96
11111	Cartucho termostático	8435195834123	35,14
1112	Cartucho 35 mm. Sin distribuidor	8435195821130	3,96
1113	Cartucho 35 mm. Con distribuidor	8435195825886	3,96
1074	Cartucho 25 mm.	8435195827972	2,80
1078	Cartucho 25 mm. - Art. 1071 - 1072	8435195834161	2,92

MONTURAS



Código	Descripción	Código Barras	€ / Ud.
1080	Montura cerámica 1/2" - Serie Esfera	8435195834116	7,57
1135	Montura cerámica - Baterías	8435195832228	3,55
18510	Montura cerámica - Art. 1068 - 1069	8435195834727	2,30
1133	Montura soleta - Grifos lavadora/lavavajillas	8435195834239	2,95
1134	Montura cerámica - Grifos lavadora/lavavajillas	8435195832211	2,95
24008	Montura cerámica - Grifos lavabo	8435195834218	3,68
19020	Montura grifo itálico	8435195834222	2,98

MANGOS



Código	Descripción	Código Barras	€ / Ud.
78005	Mango extraíble	8435195825862	7,50

CAÑOS



Código	Descripción	Código Barras	€ / Ud.
78211	Caño bajo batería	8435195832266	5,45
78210	Caño alto batería	8435195832259	4,98
78204	Caño corto batería	8435195832242	7,20
78213	Caño alto - Art. 1069	8435195828399	4,98
78215	Caño vertical - Art. 1098	8435195834178	14,40
78216	Caño vertical - Art. 1094	8435195847857	12,00

ACCESORIOS



Código	Descripción	Código Barras	€ / Ud.
19045	Volante metálico, tapa e índice	8435195832235	4,45
79005	Atomizador grifo lavabo	8435195834208	0,77
78013	Tuerca pestaña 3/4"	8435195832273	1,60
99095	Pestaña batería	8435195832280	0,68
99096	Tuerca caño 3/4"	8435195832297	1,60



ACCESORIOS DE GRIFERÍA

Fijaciones y excéntricas		58
Conexiones flexibles		59
Accesorios grifo extraíble		59
Cartuchos y monturas		60
Atomizadores		61
Adaptadores grifería		62

ACCESORIOS GRIFERÍA



FIJACIÓN GRIFERÍA MONOMANDO 1 ESPÁRRAGO



Código	Medida	Caja	Código Barras	€ / Ud.
1091	8 x 70 mm.	10	8435195820386	1,09
1093	8 x 45 mm.	10	8435195832303	0,86

- Tornillo y luna en acero inoxidable.
- Incluye junta estanqueidad para base de grifo.

FIJACIÓN GRIFERÍA MONOMANDO 2 ESPÁRRAGOS



Código	Medida	Caja	Código Barras	€ / Ud.
1092	2 Espárragos	10	8435195821062	1,20

- Tornillo y luna en acero inoxidable.
- Incluye junta estanqueidad para base de grifo.

CONJUNTO EXCÉNTRICA Y FLORÓN



	Código	Medida	Caja	Código Barras	€ / Ud.
Normal	25510	3/4" x 1/2" x 10 mm.	10	8435195801934	6,47
Gigante	25511	3/4" x 1/2" x 25 mm.	10	8435195801941	13,50
Súper gigante	25523	3/4" x 1/2" x 45 mm.	10	8435195820508	16,71

- Cuerpo latón cromado.

CUERPO EXCÉNTRICA



	Código	Medida	Caja	Código Barras	€ / Ud.
Normal	25524	3/4" x 1/2" x 10 mm.	10	8435195821420	2,40
Gigante	25525	3/4" x 1/2" x 25 mm.	10	8435195821437	5,30
Súper gigante	25527	3/4" x 1/2" x 45 mm.	10	8435195821444	6,27

- Cuerpo latón cromado.

FLORÓN CROMADO PARA EXCÉNTRICA



	Código	Medida	Caja	Código Barras	€ / Ud.
Normal	25530	Ø 65 mm.	10	8435195801958	0,88
Gigante	25531	Ø 87 mm.	10	8435195801965	1,44
Súper gigante	25532	Ø 100 mm.	10	8435195820515	3,37

ACCESORIOS GRIFERÍA



JUNTA ATOMIZADOR



Código	Medida	Caja	Código Barras	€ / Ud.
79013	Macho 14 x 22 x 2	25	8435195823745	0,046
79017	Hembra 14 x 21 x 2	25	8435195823752	0,046

FILTRO CON REJILLA



Código	Medida	Caja	Código Barras	€ / Ud.
79033	Filtro + Rejilla	25	8435195828109	0,20

INSERTO PARA ESPUMANTES PLÁSTICO



Código	Medida	Caja	Código Barras	€ / Ud.
79039	M 24/100 - H 22/100	25	8435195825831	0,27

JUEGO CONEXIÓN FLEXIBLE GRIFERÍA



Código	Medida	Caja	Código Barras	€ / Ud.
56501	H 3/8" x M 10/100 x 30 cm.	30	8435195806762	4,85
56503	H 3/8" x M 10/100 x 40 cm.	40	8435195806786	4,77
56504	H 3/8" x M 10/100 x 50 cm.	50	8435195806793	5,20

- Malla exterior acero inoxidable e interior EPDM atóxico.

FLEXO GRIFO FREGADERO EXTRAÍBLE



Código	Medida	Caja	Código Barras	€ / Ud.
50503	H 1/2" x M 3/8" x 1,25 m.	10	8435195825848	6,95
50507	H 1/2" x M 15/100	1	8435195825855	6,99

- Malla exterior acero inoxidable e interior EPDM atóxico.

FLEXO DE ACERO EXTENSIBLE



Código	Medida	Caja	Código Barras	€ / Ud.
50003	M 3/8 x H 1/2 x 1,70 m.	10	8435195825916	6,72

- Malla exterior acero inoxidable e interior EPDM atóxico.
- Longitud: 1,70 m. a 2,20 m.

MANGO DUCHA FREGADERO EXTRAÍBLE



Código	Medida	Caja	Código Barras	€ / Ud.
78005	-	1	8435195825862	7,50

PLOMADA GRIFO FREGADERO EXTRAÍBLE



Código	Medida	Caja	Código Barras	€ / Ud.
50510	-	1	8435195825879	3,54

ACCESORIOS GRIFERÍA



CARTUCHO MONOMANDO



Código	Medida	Caja	Código Barras	€ / Ud.
1110	Ø 40 mm. Sin distribuidor	1	8435195821116	3,96
1111	Ø 40 mm. Con distribuidor	1	8435195821123	3,96
1112	Ø 35 mm. Sin distribuidor	1	8435195821130	3,96
1113	Ø 35 mm. Con distribuidor	1	8435195825886	3,96

INVERSOR MONOMANDO



Código	Medida	Caja	Código Barras	€ / Ud.
1120	-	1	8435195821147	5,64

ENGANCHE PORTACADENAS



Código	Medida	Caja	Código Barras	€ / Ud.
1090	21 x 5,5	10	8435195825893	0,17

• Cromo.

MONTURA CERÁMICA



Código	Medida	Caja	Código Barras	€ / Ud.
1130	90° x 1/2	1	8435195821178	3,65
1131	180° x 1/2	1	8435195821185	3,65
1134	Grifo lavadora	1	8435195832211	2,95
1135	Batería de fregadero	1	8435195832228	3,55

MONTURA SOLETA



Código	Medida	Caja	Código Barras	€ / Ud.
1132	8 x 20 x 1/2	1	8435195825909	3,80
1133	Grifo lavadora	1	8435195834239	2,95

ACCESORIOS GRIFERÍA



FILTRO ATOMIZADOR

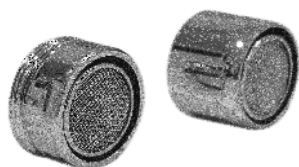

	Código	Medida	Caja	Código Barras	€ / Ud.
Bolsa	79004	Macho 18/100	100	8435195832310	1,80
	79024	Macho 20/100	100	8435195825565	0,95
	79005	Macho 22/100	1	8435195834208	0,77
	79001	Macho 24/100	100	8435195825534	0,79
	79003	Macho 28/100	100	8435195825558	1,19
	79006	Hembra 16/100	100	8435195834246	1,58
	79023	Hembra 18/100	100	8435195825770	0,95
	79007	Hembra 20/100	100	8435195842678	0,90
	79002	Hembra 22/100	100	8435195825541	0,85

	Código	Medida	Caja	Código Barras	€ / Ud.
Blister	79010	Macho 24/100	100	8435195812671	0,95
	79012	Macho 28/100	100	8435195812718	1,40
	79011	Hembra 22/100	100	8435195812695	0,99

	Código	Medida	Caja	Código Barras	€ / Ud.
Oro / Bolsa	79020	Macho 24/100	100	8435195812688	1,30
	79022	Macho 28/100	100	8435195812725	1,76
	79021	Hembra 22/100	100	8435195812701	1,41

- Fabricado en latón cromado. Disponible en color oro.
- Rejilla interior de acero inoxidable.
- Empaquetado individual.

FILTRO ATOMIZADOR ECONOMIZADOR



	Código	Medida	Caja	Código Barras	€ / Ud.
Blister	79030	Macho 24/100	25	8435195821376	1,05
	79031	Hembra 22/100	25	8435195821383	0,98



	Código	Medida	Caja	Código Barras	€ / Ud.
Blister	79032	Limitador caudal ducha 1/2"	25	8435195821451	1,90

- Fabricado en latón cromado.
- Empaquetado individual.
- Reduce el caudal de agua un 50% aprox.

FILTRO ATOMIZADOR CON RÓTULA

	Código	Medida	Caja	Código Barras	€ / Ud.
Bolsa	79015	Macho 24/100	10	8435195812749	2,88
	79016	Hembra 22/100	10	8435195812763	2,88

	Código	Medida	Caja	Código Barras	€ / Ud.
Oro / Bolsa	79025	Macho 24/100	10	8435195812756	4,48
	79026	Hembra 22/100	10	8435195812770	5,88



- Fabricado en latón cromado. Disponible en color oro.
- Rejilla interior de acero inoxidable.
- Empaquetado individual.

ACCESORIOS GRIFERÍA



ESPUMANTE FLEXIBLE



	Código	Medida		Caja	Código Barras	€ / Ud.
Blister	79035	Hembra	22/100 Latón	20	8435195825428	6,33
	79036	Hembra	22/100 Plástico	20	8435195823691	4,78
	Código	Medida		Caja	Código Barras	€ / Ud.
Blister	79038	Hembra	22/100 Plástico	20	8435195825794	5,63

- Incluye inserto, apto para grifería con roscas M 24/100 y H 22/100.
- Flexible
- Empaquetado individual.

INSERTO PARA ESPUMANTES M 24/100 - H 22/100



	Código	Medida	Caja	Código Barras	€ / Ud.
ABS	79039	M 24/100 - H 22/100	25	8435195825831	0,27
Latón	79040	M 24/100 - H 22/100	20	8435195842692	0,80

ECONOMIZADOR 2 POSICIONES CON RÓTULA



	Código	Medida		Caja	Código Barras	€ / Ud.
Blister	79042	Macho	24/100 Plástico	20	8435195825176	3,10
	79041	Hembra	22/100 Plástico	20	8435195823738	3,10

- 2 posiciones: atomizador y rociador.
- Orientable.
- Empaquetado individual.

ADAPTADOR GRIFERÍA M 24/100



	Código	Medida	Caja	Código Barras	€ / Ud.
Blister	79046	M 24/100 x M 3/4"	20	8435195825800	1,98

- Filtro atomizador en el interior.
- Empaquetado individual.

ADAPTADOR GRIFERÍA H 22/100



	Código	Medida	Caja	Código Barras	€ / Ud.
Blister	79047	H 22/100 x M 3/4"	25	8435195825817	1,98

- Filtro atomizador en el interior.
- Empaquetado individual.

ADAPTADOR GRIFERÍA ENCHUFE RÁPIDO M 24/100







	Código	Medida	Caja	Código Barras	€ / Ud.
Blister	79048	M 24/100	10	8435195842715	3,89

- Filtro atomizador en el interior.
- Empaquetado individual.



COMPLEMENTOS DE BAÑO

Mangos de ducha		64
Flexos de ducha		67
Rociadores		68
Brazos y barras de ducha		70
Soportes de ducha		71
Barras de seguridad		72

COMPLEMENTOS DE BAÑO

Mangos de ducha



MANGO DE DUCHA CRIS

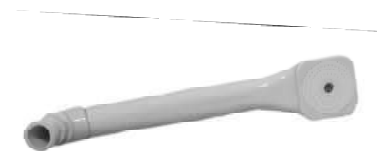

Código	Descripción	Caja	Código Barras	€ / Ud.
75001	Blanco	10	8435195812312	2,32
75002	Negro	10	8435195812329	2,46

- Una única posición.
- Con codo ABS.
- Empaquetado en bolsa individual.

MANGO DE DUCHA GOLF



Código	Descripción	Caja	Código Barras	€ / Ud.
75011	Blanco	10	8435195812336	1,53

- Una única posición.
- Empaquetado en bolsa individual.

MANGO DE DUCHA BOSTON



Código	Descripción	Caja	Código Barras	€ / Ud.
76001	Blanco	10	8435195812343	2,99
76002	Negro	10	8435195812350	2,62

- Una única posición.
- Con codo ABS cromado.
- Empaquetado en bolsa individual.

MANGO DE DUCHA FORMENTOR



Código	Descripción	Caja	Código Barras	€ / Ud.
77001	Blanco	10	8435195812367	4,16
77003	Cromo	10	8435195812374	5,52

- Una única posición.
- Con gatillo.
- Empaquetado en bolsa individual.

MANGO DE DUCHA TER CON CODO CROMADO

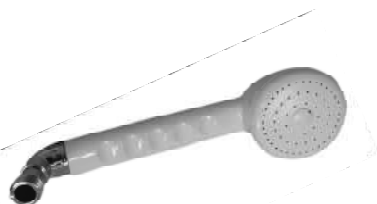

Código	Descripción	Caja	Código Barras	€ / Ud.
78001	Blanco	10	8435195812404	3,61
78002	Negro	10	8435195812411	3,18
78003	Cromo	10	8435195812428	5,88

- Una única posición.
- Con codo ABS cromado.
- Empaquetado en bolsa individual.

COMPLEMENTOS DE BAÑO

Mangos de ducha



MANGO DE DUCHA ALCUDIA

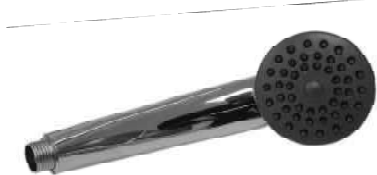

Código	Descripción	Caja	Código Barras	€ / Ud.
78101	Blanco	10	8435195812435	3,93
78103	Negro	10	8435195812459	3,32
78102	Cromo	10	8435195812442	3,49

- Una única posición.
- Con membrana antical.
- Empaquetado en bolsa individual.

MANGO DE DUCHA TOSCANA



Código	Descripción	Caja	Código Barras	€ / Ud.
78105	Cromo	10	8435195832327	6,35

- Una única posición.
- Con membrana antical.
- Empaquetado en caja individual.

MANGO DE DUCHA VIENA



Código	Descripción	Caja	Código Barras	€ / Ud.
78112	Cromo	10	8435195847734	6,92

- Una única posición.
- Con membrana antical.
- Empaquetado en caja individual.

MANGO DE DUCHA MINIMALISTA

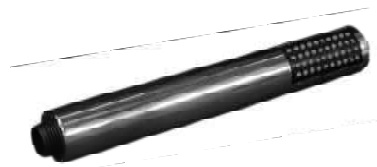

Código	Descripción	Caja	Código Barras	€ / Ud.
78106	Cromo	10	8435195820195	5,77

Código	Descripción	Caja	Código Barras	€ / Ud.
78111	Cromo	10	8435195842609	9,40

- Una única posición.
- Empaquetado en bolsa individual.

MANGO DE DUCHA 2 POSICIONES



Código	Descripción	Caja	Código Barras	€ / Ud.
78104	Cromo	10	8435195842586	5,95

- Dos posiciones.
- Membrana antical.
- Empaquetado en caja individual.

COMPLEMENTOS DE BAÑO

Mangos de ducha



MANGO DE DUCHA 5 POSICIONES



Código	Descripción	Caja	Código Barras	€ / Ud.
78107	Cromo	10	8435195820201	6,97

- Cinco posiciones.
- Membrana antical.
- Empaquetado en caja individual.

MANGO DE DUCHA PISA



Código	Descripción	Caja	Código Barras	€ / Ud.
78108	Cromo	10	8435195812466	8,99

- Cuatro posiciones.
- Membrana antical.
- Empaquetado en caja individual.

MANGO DE DUCHA ROMA



Código	Descripción	Caja	Código Barras	€ / Ud.
99233	Cromo	10	8435195812473	8,60

- Cuatro posiciones.
- Membrana antical.
- Empaquetado en caja individual.

MANGO DE DUCHA PALMA



Código	Descripción	Caja	Código Barras	€ / Ud.
78113	Cromo	10	8435195847741	7,90

- Cinco posiciones.
- Membrana antical.
- Empaquetado en caja individual.

SET DE DUCHA CLARA



Código	Descripción	Caja	Código Barras	€ / Ud.
78109	Cromo	10	8435195832334	12,58

- Mango ducha cinco posiciones con membrana antical.
- Soporte cónico cromado.
- Flexo cromado reforzado de 1,70 m.
- Empaquetado en blister con colgador.

CODO DUCHA CROMADO



Código	Descripción	Caja	Código Barras	€ / Ud.
77002	Latón	10	8435195812381	5,12
77005	ABS	25	8435195812398	0,91

COMPLEMENTOS DE BAÑO

Flexos de ducha



FLEXO DE ACERO TUERCA GRAFILADA



Código	Medida	Caja	Código Barras	€ / Ud.
50001	1,5 m.	10	8435195806557	3,43
50002	2 m.	10	8435195806564	4,29

- Doble engatillado reforzado.
- Tuercas hexagonales rosca hembra 1/2".
- Tubo interior EPDM.

FLEXO DE ACERO TUERCA CÓNICA



Código	Medida	Caja	Código Barras	€ / Ud.
50513	1,20 m.	10	8435195839555	5,19
50501	1,5 m.	10	8435195806571	4,70
50508	1,75 m.	10	8435195806588	4,19
50502	2 m.	10	8435195806595	5,92

- Doble engatillado reforzado.
- Tuerca cónica y tuerca hexagonal rosca hembra 1/2".
- Tubo interior EPDM.

FLEXO DE ACERO EXTENSIBLE

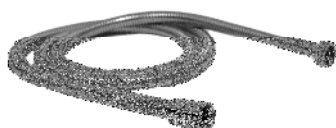

Código	Medida	Caja	Código Barras	€ / Ud.
50504	1,75 m. a 2,40 m.	10	8435195806601	7,89

- Doble engatillado reforzado.
- Tuerca cónica y tuerca hexagonal rosca hembra 1/2".
- Tubo interior EPDM.

FLEXO DE PVC TUERCA CÓNICA



	Código	Medida	Caja	Código Barras	€ / Ud.
Blanco	52001	1,5 m.	10	8435195806649	3,78
	52002	2 m.	10	8435195806656	3,84

	Código	Medida	Caja	Código Barras	€ / Ud.
Negro y cromo	52003	1,5 m.	10	8435195827934	2,51
	52004	2 m.	10	8435195827941	4,26



- Tuerca cónica y tuerca hexagonal rosca hembra 1/2".

COMPLEMENTOS DE BAÑO

Rociadores



ROCIADOR DUCHA



Código	Medida	Caja	Código Barras	€ / Ud.
78402	1/2" x Ø 60 mm.	20	8435195812527	2,15

- Fabricado en latón cromado.



Código	Medida	Caja	Código Barras	€ / Ud.
78404	1/2" x Ø 90 mm.	20	8435195812534	2,89

- Fabricado en latón cromado.



Código	Medida	Caja	Código Barras	€ / Ud.
78403	1/2" x Ø 50 mm.	20	8435195812541	0,55

- Fabricado en ABS blanco.



Código	Medida	Caja	Código Barras	€ / Ud.
78407	1/2" Pared	10	8435195825930	39,70

- Fabricado en latón cromado.
- Antivandálico.

ROCIADOR DUCHA CON RÓTULA



Código	Medida	Caja	Código Barras	€ / Ud.
79018	1/2" X Ø 43 mm.	10	8435195824629	16,64

- Fabricado en latón cromado.
- Rótula y rosca en latón cromado.



Código	Medida	Caja	Código Barras	€ / Ud.
79014	1/2" x Ø 60 mm.	10	8435195812664	5,81

- Fabricado en ABS cromado.
- Rótula y rosca en latón cromado.

ROCIADOR DUCHA CLARA



Código	Medida	Caja	Código Barras	€ / Ud.
78408	1/2"	10	8435195820225	6,60

- Fabricado en ABS cromado, con membrana antical.
- Cinco posiciones.



Código	Medida	Caja	Código Barras	€ / Ud.
78411	1/2"	10	8435195825947	6,60

- Fabricado en ABS cromado, con membrana antical.
- Tres posiciones.

COMPLEMENTOS DE BAÑO

Rociadores



ROCIADOR DUCHA REDONDO ABS



Código	Medida	Caja	Código Barras	€ / Ud.
78409	1/2" x Ø 200 mm.	10	8435195820232	16,90

- Fabricado en ABS cromado.
- Rótula de latón cromado.
- Membrana antical.
- Empaquetado en caja blanca individual.

ROCIADOR DUCHA CUADRADO ABS

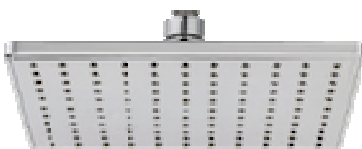

Código	Medida	Caja	Código Barras	€ / Ud.
78412	1/2" X Ø 200 mm.	10	8435195842623	20,65

- Fabricado en ABS cromado.
- Rótula de latón cromado.
- Extrafino 1 cm.
- Membrana antical.
- Empaquetado en caja blanca individual.

ROCIADOR DUCHA REDONDO ACERO INOXIDABLE



Código	Medida	Caja	Código Barras	€ / Ud.
78413	1/2" x Ø 200 mm.	10	8435195847659	18,70

- Fabricado en acero inoxidable.
- Rótula y rosca de latón cromado.
- Membrana antical.
- Empaquetado en caja blanca individual.

ROCIADOR DUCHA CUADRADO ACERO INOXIDABLE



Código	Medida	Caja	Código Barras	€ / Ud.
78414	1/2" x Ø 200 mm.	10	8435195847666	18,70

- Fabricado en acero inoxidable.
- Rótula y rosca de latón cromado.
- Membrana antical.
- Empaquetado en caja blanca individual.

ROCIADOR DUCHA ESTRELLA



Código	Medida	Caja	Código Barras	€ / Ud.
78410	1/2" X Ø 220 mm.	10	8435195820249	28,40

- Fabricado en latón cromado.
- Rótula y rosca de latón cromado.
- Membrana antical.
- Empaquetado en caja blanca individual.

COMPLEMENTOS DE BAÑO

Brazos de ducha



BRAZO DE DUCHA



Código	Medida	Caja	Código Barras	€ / Ud.
78201	1/2" x 250 mm.	10	8435195812480	6,64
78202	1/2" x 300 mm.	10	8435195812497	8,10
78205	1/2" x 400 mm.	10	8435195812503	7,68

- Fabricado en acero inoxidable.
- Cromado.

BRAZO DE DUCHA FUNDIDO



Código	Medida	Caja	Código Barras	€ / Ud.
78206	1/2" x 150 mm.	10	8435195825923	7,47

- Cromado.
- Plafón cromado ABS.

BRAZO DE DUCHA MANANTIAL



Código	Medida	Caja	Código Barras	€ / Ud.
78207	1/2" x 370 mm.	10	8435195828009	13,65

- Fabricado en acero inoxidable.
- Cromado.
- Diametro tubo Ø 20 mm.
- Plafón cromado.

BRAZO DE DUCHA CURVO

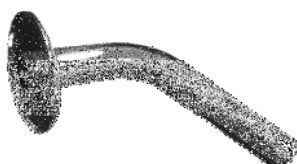

Código	Medida	Caja	Código Barras	€ / Ud.
78209	1/2"	10	8435195820218	3,32

- Fabricado en acero inoxidable.
- Cromado.
- Diametro tubo Ø 20 mm.
- Plafón cromado.

BRAZO DE DUCHA CURVO



Código	Medida	Caja	Código Barras	€ / Ud.
78208	1/2" x 200 mm.	10	8435195847840	7,15

- Fabricado en acero inoxidable.
- Cromado.
- Diametro tubo Ø 20 mm.
- Plafón cromado.

BARRA DE DUCHA DESLIZANTE



Código	Medida	Caja	Código Barras	€ / Ud.
99235	Ø 28 mm. x 61 cm.	5	8435195812510	12,67

- Cromado.
- Jabonera deslizable.

COMPLEMENTOS DE BAÑO

Soportes de ducha



SOPORTE DE DUCHA GIRATORIO



	Código	Descripción	Caja	Código Barras	€ / Ud.
ABS	78601	Negro	10	8435195812558	1,48
	78602	Blanco	10	8435195812565	1,49
	78603	Cromo	10	8435195812572	2,68

• Para flexos de ducha con tuerca cónica.

SOPORTE DE DUCHA GIRATORIO LUNA



	Código	Descripción	Caja	Código Barras	€ / Ud.
ABS	78609	Cromo	10	8435195832341	2,40

• Para flexos de ducha con tuerca cónica.

SOPORTE DE DUCHA BAYONETA



	Código	Descripción	Caja	Código Barras	€ / Ud.
ABS	78606	Blanco	10	8435195812596	2,32
	78604	Cromo	10	8435195825954	4,50

• Para flexos de ducha con tuerca cónica.

SOPORTE DE DUCHA CROMO



	Código	Descripción	Caja	Código Barras	€ / Ud.
ABS	78806	Cromo	10	8435195812596	1,92

• Para flexos de ducha con tuerca cónica.

SOPORTE DE DUCHA HORQUILLA



	Código	Descripción	Caja	Código Barras	€ / Ud.
Metal	78608	Cromo	10	8435195825978	9,86

• Para flexos de ducha con tuerca redonda o hexagonal.

SOPORTE DE DUCHA HORQUILLA CROMO



	Código	Descripción	Caja	Código Barras	€ / Ud.
ABS	78804	Cromo	10	8435195842630	2,17

• Para flexos de ducha con tuerca cónica.

SOPORTE DE DUCHA



	Código	Descripción	Caja	Código Barras	€ / Ud.
Metal	78802	Cromo - Sin toma	10	8435195812626	4,68
ABS	78803	Cromo - Sin toma	10	8435195812633	3,93
ABS	78805	Blanco - Sin toma	10	8435195812657	1,20

• Para flexos de ducha con tuerca redonda o hexagonal.

COMPLEMENTOS DE BAÑO

Soportes de ducha



CODO CON TOMA PARA FLEXO DE DUCHA



Código	Medida	Caja	Código Barras	€ / Ud.
78807	M 1/2" x M 1/2"	10	8435195842654	11,70

SOPORTE CON TOMA PARA FLEXO DE DUCHA



Código	Medida	Caja	Código Barras	€ / Ud.
78808	M 1/2" x M 1/2"	10	8435195842661	9,43

BARRA DE SEGURIDAD PARA BAÑO-DUCHA



Código	Medida	Caja	Código Barras	€ / Ud.
78809	30 cm.	1	8435195832358	29,54
78810	40 cm.	1	8435195832365	35,95
78811	50 cm.	1	8435195832372	39,36

- Plafones y fijaciones de latón.
- Ø 25 mm.
- Empaquetado en blister individual.



VÁLVULAS DESAGÜE

Válvulas click-clack		74
Válvulas automáticas y manuales		76
Válvulas bañera y ducha		77
Tapa orificios y tapones		79
Cadena y anillas		80

VÁLVULAS DESAGÜE

Válvulas Click-Clack



VÁLVULA DESAGÜE CLICK-CLACK LAVABO / BIDÉ ABS



Código	Medida	Caja	Código Barras	€ / Ud.
25561	1 1/4"	10	8435195821581	5,86

- Válvula universal **con y sin rebosadero.**
- Fabricada en ABS cromado.

VÁLVULA DESAGÜE CLICK-CLACK LAVABO / BIDÉ



Código	Medida	Caja	Código Barras	€ / Ud.
25500	1 1/4"	10	8435195821567	11,95

- Válvula universal **con y sin rebosadero.**
- Fabricada en latón cromado.

	Código	Descripción	Código Barras	€ / Ud.
Recambio	25528	Junta ABS	8435195825985	0,40

VÁLVULA DESAGÜE CLICK-CLACK LAVABO / BIDÉ LUJO



Código	Medida	Caja	Código Barras	€ / Ud.
25501	1 1/4"	10	8435195821574	14,96

- Válvula universal **con y sin rebosadero.**
- Fabricada en latón cromado.

VÁLVULA DESAGÜE CLICK-CLACK LAVABO / BIDÉ LUJO



Código	Medida	Caja	Código Barras	€ / Ud.
25502	1 1/4"	10	8435195825992	15,68

- Válvula universal **con y sin rebosadero.**
- Fabricada en latón cromado.
- Tapón cuadrado.

VÁLVULAS DESAGÜE

Válvulas Click-Clack



VÁLVULA DESAGÜE CLICK-CLACK LAVABO / BIDÉ



Código	Medida	Caja	Código Barras	€ / Ud.
25513	1 1/4"	10	8435195817768	10,32

- Válvula universal **sin rebosadero**.
- Fabricada en latón cromado.

VÁLVULA DESAGÜE CLICK-CLACK LAVABO / BIDÉ



Código	Medida	Caja	Código Barras	€ / Ud.
25515	1 1/4"	10	8435195817775	11,20

- Válvula universal **con rebosadero**.
- Fabricada en latón cromado.

VÁLVULA DESAGÜE CLICK-CLACK BAÑERA



Código	Medida	Caja	Código Barras	€ / Ud.
25516	1 1/2"	10	8435195817782	9,89

- Fabricada en latón cromado.

VÁLVULA DESAGÜE CLICK-CLACK BIDÉ



Código	Medida	Caja	Código Barras	€ / Ud.
25529	1 1/4"	10	8435195825374	14,91

- Fabricada en latón cromado.

VÁLVULAS DESAGÜE



VÁLVULA DESAGÜE AUTOMÁTICA LAVABO / BIDÉ



Código	Medida	Caja	Código Barras	€ / Ud.
25512	1 1/4"	2	8435195817744	14,11

- Fabricada en latón cromado.

VÁLVULA DESAGÜE AUTOMÁTICA LAVABO ABS



Código	Medida	Caja	Código Barras	€ / Ud.
44026	1 1/4"	2	8435195837070	6,70

- Fabricada en ABS cromado.

VARILLA VÁLVULA DESAGÜE AUTOMÁTICA LAVABO



Código	Medida	Caja	Código Barras	€ / Ud.
44027	-	2	8435195837087	1,11

- Fabricada en acero inoxidable.

VÁLVULA DESAGÜE LAVABO / BIDÉ



Código	Medida	Caja	Código Barras	€ / Ud.
25579	1 1/4" x 70 Ø	100	8435195832488	2,74

VÁLVULA DESAGÜE LAVABO / BIDÉ



Código	Medida	Caja	Código Barras	€ / Ud.
25580	1 1/2" x 70 Ø	100	8435195832495	3,86

REJILLA FILTRO INOX PARA VÁLVULA DESAGÜE



Código	Medida	Caja	Código Barras	€ / Ud.
85129	68 mm.	2	8435195844825	1,33

- Filtro de acero superponible para válvulas de desagüe de Ø 70 mm.

VÁLVULAS DESAGÜE

Válvulas bañera/ducha



CONJUNTO BAÑERA CON REBOSADERO HORIZONTAL CLICK CLACK



Código	Medida	Caja	Código Barras	€ / Ud.
25591	1 1/2" x 40 mm. Ø	25	8435195847727	22,75

- Incluye junta reductora de Ø 40 mm. a Ø 32 mm.
- Tapón click clack.
- Salida horizontal orientable.

CONJUNTO BAÑERA CON REBOSADERO HORIZONTAL



Código	Medida	Caja	Código Barras	€ / Ud.
25514	1 1/2" x 40 mm. Ø	25	8435195817751	8,23

- Cadena de bolas en latón cromado.
- Incluye junta reductora de Ø 40 mm. a Ø 32 mm.

CONJUNTO BAÑERA CON REBOSADERO SIFÓNICO



Código	Medida	Caja	Código Barras	€ / Ud.
25563	1 1/2" x 40 mm. Ø	25	8435195835724	9,59

- Cadena de bolas en latón cromado.
- Incluye junta reductora de Ø 40 mm. a Ø 32 mm.

VÁLVULA DUCHA SIFÓNICA EXTRAPLANA SIN EMBELLECEDOR



Código	Medida	Caja	Código Barras	€ / Ud.
25595	1 1/2" x 40 mm. Ø	10	8435195835762	15,98

- Sin embellecedor.
- Juego de tornillos en latón.
- Sifón totalmente extraíble para facilitar su limpieza.
- Gran caudal de desagüe.

VÁLVULA DUCHA SIFÓNICA EXTRAPLANA CON EMBELLECEDOR



Código	Medida	Caja	Código Barras	€ / Ud.
25596	1 1/2" x 40 mm. Ø	10	8435195835779	18,24

- Con embellecedor cromado extraplano 110 mm Ø.
- Juego de tornillos en latón.
- Sifón totalmente extraíble para facilitar su limpieza.
- Gran caudal de desagüe.

VÁLVULAS DESAGÜE

Válvulas bañera/ducha



VÁLVULA PLATO DE DUCHA PARA BOTE SIFÓNICO Ø 80



Código	Medida	Caja	Código Barras	€ / Ud.
25582	1 1/4" x 32 mm. Ø	25	8435195832518	2,94

- Con orificio de 60 mm Ø.
- Con rejilla en acero inoxidable de 80 mm Ø.
- Salida horizontal 40 mm. Ø con reductora a 32 mm. Ø.

VÁLVULA PLATO DE DUCHA PARA BOTE SIFÓNICO Ø 115



Código	Medida	Caja	Código Barras	€ / Ud.
25586	1 1/2" x 40 mm. Ø	10	8435195832556	6,56

- Válvula sifónica con orificio de 90 mm. Ø.
- Con rejilla en acero inoxidable de 115 mm Ø.
- Salida horizontal 40 mm. Ø con reductora a 32 mm. Ø.

VÁLVULA PLATO DE DUCHA SIFÓNICA HORIZONTAL Ø 80



Código	Medida	Caja	Código Barras	€ / Ud.
25583	1 1/2" x 40 mm. Ø	25	8435195832525	4,09

- Con orificio de 60 mm. Ø.
- Con rejilla en acero inoxidable de 80 mm Ø.
- Salida orientable 40 mm. Ø con reductora a 32 mm. Ø.

VÁLVULA PLATO DE DUCHA REGISTRABLE Ø 90



Código	Medida	Caja	Código Barras	€ / Ud.
25584	1 1/2" x 40 mm. Ø	10	8435195832532	6,98

- Válvula sifónica con orificio de 60 mm. Ø.
- Con embellecedor champiñón en acero inoxidable de 90 mm. Ø.
- Salida horizontal 40 mm. Ø con reductora a 32 mm. Ø.

VÁLVULA PLATO DE DUCHA REGISTRABLE Ø 120



Código	Medida	Caja	Código Barras	€ / Ud.
25585	1 1/2" x 40 mm. Ø	10	8435195832549	16,47

- Válvula sifónica con orificio de 90 mm. Ø.
- Con embellecedor champiñón en acero inoxidable de 120 mm. Ø.
- Salida horizontal 40 mm. Ø con reductora a 32 mm. Ø.

VÁLVULAS DESAGÜE

Accesorios



TAPA ORIFICIOS LAVABO / BIDÉ



	Código	Descripción	Caja	Código Barras	€ / Ud.
Inox.	74501	Cromo con enganche	25	8435195812282	1,54

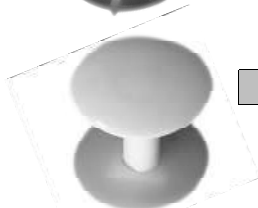

	Código	Descripción	Caja	Código Barras	€ / Ud.
ABS	74502	Blanco - Ciego	25	8435195812299	0,46
	74503	Cromo - Ciego	25	8435195812305	0,69



	Código	Descripción	Caja	Código Barras	€ / Ud.
ABS	74506	Blanco	25	8435195832563	0,67
	74507	Cromo	25	8435195832570	0,89



	Código	Descripción	Caja	Código Barras	€ / Ud.
ABS	74505	Embellecedor cromo	25	8435195828092	0,48

TAPONES DE CAUCHO

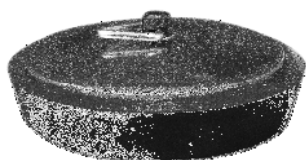

	Código	Medida	Caja	Código Barras	€ / Ud.
	85001	24 Ø	25	8435195814729	0,48
	85002	28 Ø	25	8435195814736	0,59
	85003	30 Ø	25	8435195814743	0,48
	85004	32 Ø	25	8435195814750	0,49
	85005	34 Ø	25	8435195814767	0,58
	85006	36 Ø	25	8435195814774	0,63
	85007	38 Ø	25	8435195814781	0,64
	85008	40 Ø	25	8435195814798	0,66
	85009	42 Ø	25	8435195814804	0,66
	85010	44 Ø	25	8435195814811	0,69
	85011	47 Ø	25	8435195814828	0,81
	85012	50 Ø	25	8435195814835	0,86
	85013	51 Ø	25	8435195814842	0,81
Universal fregadero	85014	55 Ø	25	8435195814859	0,67
	85015	61 Ø	25	8435195814866	0,99
Universal TEKA - JIMTEN	85017	46 Ø	25	8435195814880	0,72

• Con embellecedor en acero inoxidable.

VÁLVULAS DESAGÜE

Accesorios



ROLLO CADENA DE BOLAS CROMADA

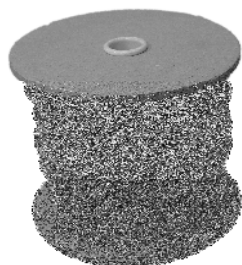

Código	Medida	Caja	Código Barras	€ / Ud.
85101	3,2 mm. Ø x 50 m.	1	8435195815078	54,50
85102	3,8 mm. Ø x 50 m.	1	8435195815085	68,50

CADENA DE BOLAS CROMADA CON ANILLAS



Código	Medida	Caja	Código Barras	€ / Ud.
85103	3,2 mm. Ø x 27 cm.	25	8435195815092	0,62
85104	3,2 mm. Ø x 42 cm.	25	8435195815108	0,71

Código	Medida	Caja	Código Barras	€ / Ud.
85105	3,8 mm. Ø x 27 cm.	25	8435195815115	0,72
85106	3,8 mm. Ø x 42 cm.	25	8435195815122	1,23

ANILLA TRIÁNGULO



	Código	Medida	Caja	Código Barras	€ / Ud.
Inox.	85110	Pequeña	100	8435195815139	0,04
	85112	Grande	100	8435195815153	0,04

ANILLA LLAVERO



	Código	Descripción	Caja	Código Barras	€ / Ud.
Inox.	85117	Pequeña	100	8435195823677	0,06
	85111	Grande	100	8435195815146	0,10

ENGANCHE "U"



	Código	Descripción	Caja	Código Barras	€ / Ud.
Inox.	85113	3,2 mm.	100	8435195815160	0,06
	85114	3,8 mm.	100	8435195815177	0,06

ENGANCHE LLAVERO TUBULAR



	Código	Descripción	Caja	Código Barras	€ / Ud.
Inox.	85115	3,2 mm.	100	8435195815184	0,08
	85116	3,8 mm.	100	8435195815191	0,06



FILTROS DESAGÜE

Filtros desagüe



82

FILTROS DESAGÜE



FILTRO DESAGÜE ACERO INOXIDABLE



Código	Medida	Caja	Código Barras	€ / Ud.
85130	50 x 30 Lavabo / Bidé	10	8435195832587	0,69
85131	65 x 40 Fregadero / Bañera	10	8435195832594	0,80
85132	80 x 50 Fregadero / Bañera	10	8435195832600	0,88

FILTRO DESAGÜE BLANCO



Código	Medida	Caja	Código Barras	€ / Ud.
85135	65 x 40 Fregadero / Bañera	10	8435195832617	1,28
85136	80 x 50 Fregadero / Bañera	10	8435195832624	1,95

FILTRO DESAGÜE CAZOLETA



Código	Medida	Caja	Código Barras	€ / Ud.
85140	65 x 40 Fregadero / Bañera	10	8435195832631	1,95

FILTRO DESAGÜE TEKA



Código	Medida	Caja	Código Barras	€ / Ud.
85141	Inox. - 81 x 31 Fregadero	10	8435195832648	2,97
85142	Blanco - 81 x 31 Fregadero	10	8435195832655	2,83



FILTRO DESAGÜE TEKA CON EJE CENTRAL



Código	Medida	Caja	Código Barras	€ / Ud.
85143	81 x 31 Fregadero	10	8435195832662	3,91



SIFONES DESAGÜE Y ACCESORIOS

Sifones desagüe		84
Accesorios		87

SIFONES DESAGÜE



SIFÓN BOTELLA CROMADO



Código	Medida	Caja	Código Barras	€ / Ud.
63520	1 1/4" x 32 mm Ø	10	8435195809800	16,80

- Fabricado en latón cromado.
- Para lavabo y bidé.
- Sin válvula.

SIFÓN BOTELLA MINIMALISTA



Código	Medida	Caja	Código Barras	€ / Ud.
63515	1 1/4" x 32 mm Ø	10	8435195821598	37,63

- Fabricado en latón cromado.
- Para lavabo y bidé.
- Sin válvula.

TUBO ALARGO ABOCARDADO PARA SIFÓN BOTELLA



	Código	Medida	Caja	Código Barras	€ / Ud.
	63526	Ø 32 x 20 cm.	1	8435195823639	3,76
	63528	Ø 32 x 30 cm.	1	8435195823646	3,99
Sin pestaña	63544	Ø 32 x 20 cm.	1	8435195841589	3,12
Sin pestaña	63545	Ø 32 x 80 cm.	1	8435195826005	8,40

- Fabricado en latón cromado.

TUBO SIFÓN EXTENSIBLE BLANCO



	Código	Medida	Caja	Código Barras	€ / Ud.
Tuerca PVC	63510	1 1/4" x 32 mm Ø	10	8435195809718	1,59
	63511	1 1/2" x 40 mm Ø	10	8435195809725	2,87

	Código	Medida	Caja	Código Barras	€ / Ud.
Tuerca METAL	63512	1 1/4" x 32 mm Ø	10	8435195809732	1,76
	63513	1 1/2" x 40 mm Ø	10	8435195809749	3,25

TUBO SIFÓN EXTENSIBLE CROMADO



	Código	Medida	Caja	Código Barras	€ / Ud.
	63518	1 1/4" x 32 mm Ø	10	8435195809756	7,30
	63519	1 1/2" x 40 mm Ø	10	8435195809763	7,30

TUBO ALARGO EXTENSIBLE



	Código	Medida	Caja	Código Barras	€ / Ud.
	63523	Blanco Ø 32 - 40	10	8435195809770	2,15
	63524	Cromo Ø 32 - 40	10	8435195809787	5,44

SIFONES DESAGÜE



SIFÓN "Y" CON VÁLVULA LAVABO / BIDÉ



Código	Medida	Caja	Código Barras	€ / Ud.
25570	1 1/2" x 40 mm. Ø	50	8435195832396	5,91

- Rejilla de Ø 70 mm. de acero inoxidable.
- Cadena de bolas en latón cromado.
- Incluye junta reductora de Ø 40 mm. a Ø 32 mm.

SIFÓN BOTELLA CORTO EXTENSIBLE



Código	Medida	Caja	Código Barras	€ / Ud.
25571	1 1/4" x 40 mm. Ø	50	8435195832402	7,48

- Rejilla de Ø 70 mm. de acero inoxidable.
- Cadena de bolas en latón cromado.
- Incluye junta reductora de Ø 40 mm. a Ø 32 mm.

SIFÓN BOTELLA EXTENSIBLE



Código	Medida	Caja	Código Barras	€ / Ud.
25572	1 1/2" x 40 mm. Ø	50	8435195832419	6,22

- Rejilla de Ø 70 mm. de acero inoxidable.
- Cadena de bolas en latón cromado.
- Incluye junta reductora de Ø 40 mm. a Ø 32 mm.

SIFÓN BOTELLA EXTENSIBLE CON RACOR



Código	Medida	Caja	Código Barras	€ / Ud.
25574	1 1/2" x 40 mm. Ø	50	8435195832433	4,12

- Incluye junta reductora de Ø 40 mm. a Ø 32 mm.

SIFÓN CURVO EXTENSIBLE



Código	Medida	Caja	Código Barras	€ / Ud.
25573	1 1/2" x 40 mm. Ø	50	8435195832426	6,50

- Rejilla de Ø 70 mm. de acero inoxidable.
- Cadena de bolas en latón cromado.
- Incluye junta reductora de Ø 40 mm. a Ø 32 mm.

SIFÓN CURVO EXTENSIBLE CON RACOR



Código	Medida	Caja	Código Barras	€ / Ud.
25575	1 1/2" x 40 mm. Ø	50	8435195832440	4,37

- Incluye junta reductora de Ø 40 mm. a Ø 32 mm.

SIFONES DESAGÜE



SIFÓN DOBLE BOTELLA EXTENSIBLE DOBLE RACOR



Código	Medida	Caja	Código Barras	€ / Ud.
25578	1 1/2" x 40 mm. Ø	14	8435195832471	6,37

- Incluye junta reductora de Ø 40 mm. a Ø 32 mm.

SIFÓN DOBLE CURVO EXTENSIBLE DOBLE RACOR



Código	Medida	Caja	Código Barras	€ / Ud.
25577	1 1/2" x 40 mm. Ø	10	8435195832464	9,26

- Incluye junta reductora de Ø 40 mm. a Ø 32 mm.

SIFÓN DOBLE CURVO EXTENSIBLE ORIENTABLE DOBLE RACOR



Código	Medida	Caja	Código Barras	€ / Ud.
25576	1 1/2" x 40 mm. Ø	17	8435195832457	8,16

- Incluye junta reductora de Ø 40 mm. a Ø 32 mm.

SIFÓN DE GOMA ABIERTO PARED



Código	Medida	Caja	Código Barras	€ / Ud.
85025	25 - 30 mm. Ø	30	8435195814996	2,87
85026	30 - 30 mm. Ø	30	8435195815009	4,38
85027	35 - 35 mm. Ø	30	8435195815016	4,38
85033	35 - 40 mm. Ø	10	8435195822717	4,38
85034	40 - 40 mm. Ø	10	8435195822724	3,26

SIFÓN DE GOMA CERRADO SUELO



Código	Medida	Caja	Código Barras	€ / Ud.
85028	25 - 30 mm. Ø	30	8435195815023	3,08
85029	30 - 30 mm. Ø	30	8435195815030	3,26
85030	35 - 35 mm. Ø	30	8435195815047	3,26
85035	40 - 40 mm. Ø	10	8435195822731	5,14

SIFÓN DE GOMA DOBLE FREGADERO CON TOMA

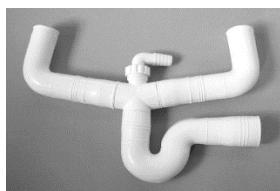

Código	Medida	Caja	Código Barras	€ / Ud.
85031	35 - 35 - 35 mm. Ø	10	8435195815054	14,72

SIFONES DESAGÜE

Accesorios



VÁLVULA DESAGÜE FREGADERO



Código	Medida	Caja	Código Barras	€ / Ud.
25581	1 1/2" x 85 mm. Ø	100	8435195832501	4,78

VÁLVULA COMPLETA PARA SIFÓN DE GOMA



Código	Medida	Caja	Código Barras	€ / Ud.
25518	30 Ø	2	8435195817799	5,85
63532	35 Ø	2	8435195823615	6,99
63533	40 Ø	2	8435195823622	3,50

VÁLVULA CON TAPÓN DE CAUCHO PARA SIFÓN BOTELLA

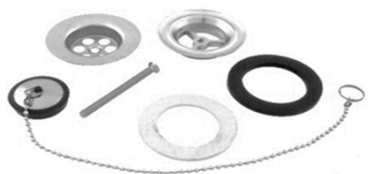

Código	Medida	Caja	Código Barras	€ / Ud.
63522	1 1/4"	1	8435195809824	5,85

JUNTA CAUCHO CÓNICA PARA SIFÓN



Código	Medida	Caja	Código Barras	€ / Ud.
25587	1 1/4" x 32 mm. Ø	100	8435195835731	0,48
25589	1 1/2" x 40 mm. Ø	100	8435195835755	0,38

CONJUNTO TUERCAS, GOMAS Y FLORÓN PARA SIFÓN BOTELLA



Código	Medida	Caja	Código Barras	€ / Ud.
63527	Única	1	8435195823653	4,20

FLORÓN ABS



Código	Medida	Caja	Código Barras	€ / Ud.
63546	32 Ø Cromo	10	8435195826012	0,55
63547	40 Ø Cromo	10	8435195826029	0,55
63548	32 Ø Blanco	10	8435195826036	0,29
63549	40 Ø Blanco	10	8435195826043	0,24



ENCHUFES DE GOMA

Enchufes de goma



90

ACCESORIOS DE GOMA



ENCHUFE DE GOMA A PRESIÓN INODORO

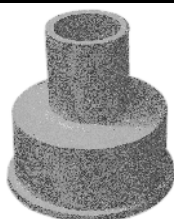

Código	Medida	Caja	Código Barras	€ / Ud.
85021	25 mm.	50	8435195814903	1,05
85022	30 mm.	50	8435195814910	1,05

ENCHUFE DE GOMA A PRESIÓN INODORO VICTORIA



Código	Medida	Caja	Código Barras	€ / Ud.
85020	63 Ø Sin cuello	50	8435195814927	1,29
85024	63 Ø Con cuello	50	8435195814941	1,48

ENCHUFE DE GOMA A PRESIÓN INODORO LUCERNA



Código	Medida	Caja	Código Barras	€ / Ud.
85038	53 Ø Sin cuello	50	8435195833737	1,25
85023	53 Ø Con cuello	50	8435195814934	1,27

ENCHUFE DE LÁTEX A PRESIÓN INODORO



Código	Medida	Caja	Código Barras	€ / Ud.
99347	25 mm.	50	8435195814972	1,16
99348	30 mm.	50	8435195814989	1,16

GOMA ALIMENTADOR LUCERNA - VICTORIA

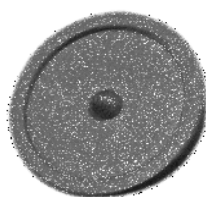

Código	Medida	Caja	Código Barras	€ / Ud.
98024	28 Ø	50	8435195814965	0,45

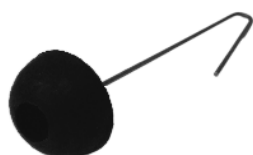

BOYA ROYAL CON VARILLA DE LATÓN



Código	Medida	Caja	Código Barras	€ / Ud.
85032	-	10	8435195815061	1,86



CABEZALES UNIVERSALES, ACCESORIOS Y REPUESTOS

Cabezales universales		92
Accesorios		94
Repuestos		95

CABEZALES UNIVERSALES



CABEZAL UNIVERSAL VISTO VOLANTE 3 PUNTAS METÁLICO



Código	Medida	Caja	Código Barras	€ / Ud.
40001	16/150	12	8435195803945	4,94
40002	17/150	12	8435195803952	4,94
40003	18/150	12	8435195803969	4,38
40004	19/150	12	8435195803976	4,38
40005	20/125	12	8435195803983	5,10
40006	20/150	12	8435195803990	5,10
40007	21/125	12	8435195804003	5,27
40008	21/150	12	8435195804010	5,27
40009	22/150	12	8435195804027	5,27
40010	23/150	12	8435195836981	5,18
40011	3/8"	12	8435195804034	4,70
40012	1/2"	12	8435195804041	4,55
40013	5/8"	12	8435195804058	5,33
40014	3/4"	12	8435195804065	6,17
40015	26/150	12	8435195804072	5,99

CABEZAL UNIV. EMPOTRAR VOLANTE 3 PUNTAS METÁLICO



Código	Medida	Caja	Código Barras	€ / Ud.
41001	16/150	12	8435195804089	5,90
41002	17/150	12	8435195804096	5,90
41003	18/150	12	8435195804102	5,30
41004	19/150	12	8435195804119	5,98
41005	20/125	12	8435195804126	6,07
41006	20/150	12	8435195804133	5,61
41007	21/125	12	8435195804140	6,23
41008	21/150	12	8435195804157	6,08
41009	22/150	12	8435195804164	5,70
41010	23/150	12	8435195836998	6,05
41011	3/8"	12	8435195804171	5,65
41012	1/2"	12	8435195804188	6,38
41013	5/8"	12	8435195804195	6,41
41014	3/4"	12	8435195804201	6,12
41019	26/150	12	8435195804218	6,34

CABEZALES UNIVERSALES



CABEZAL UNIVERSAL VISTO VOLANTE FACETADO METÁLICO



Código	Medida	Caja	Código Barras	€ / Ud.
42001	16/150	12	8435195804232	8,48
42002	17/150	12	8435195804249	8,48
42003	18/150	12	8435195804256	8,48
42004	19/150	12	8435195804263	8,48
42005	20/125	12	8435195804270	8,58
42006	20/150	12	8435195804287	8,48
42007	21/125	12	8435195804294	8,78
42008	21/150	12	8435195804300	8,78
42009	22/150	12	8435195804317	8,78
42010	23/150	12	8435195837032	8,78
42011	3/8"	12	8435195804324	8,48
42012	1/2"	12	8435195804331	8,78
42013	5/8"	12	8435195804348	8,78
42014	3/4"	12	8435195804355	8,98
42015	26/150	12	8435195821048	8,98

CABEZAL UNIV. EMPOTRAR VOLANTE FACETADO METÁLICO



Código	Medida	Caja	Código Barras	€ / Ud.
43001	16/150	12	8435195804362	9,24
43002	17/150	12	8435195804379	9,24
43003	18/150	12	8435195804386	9,24
43004	19/150	12	8435195804393	9,24
43005	20/125	12	8435195804409	9,55
43006	20/150	12	8435195804416	9,55
43007	21/125	12	8435195804423	9,72
43008	21/150	12	8435195804430	9,72
43009	22/150	12	8435195804447	9,72
43010	23/150	12	8435195837049	9,72
43011	3/8"	12	8435195804454	9,24
43012	1/2"	12	8435195804461	9,72
43013	5/8"	12	8435195804478	9,78
43014	3/4"	12	8435195804485	9,78
43019	26/150	12	8435195821055	9,78

CABEZALES UNIVERSALES



RECAMBIO ALARGADERAS CABEZALES

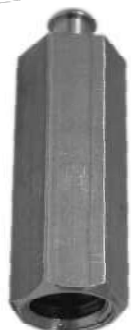

Código	Medida	Caja	Código Barras	€ / Ud.
86001	28 mm.	12	8435195815207	0,51
86002	32 mm.	12	8435195815214	0,58
86003	40 mm.	12	8435195815221	0,77
86004	45 mm.	12	8435195815238	0,99
86005	50 mm.	12	8435195815245	1,03
86006	57 mm.	12	8435195815252	1,12
86007	67 mm.	12	8435195815269	1,42
86008	97 mm.	12	8435195815276	2,62

PLACA MEDIDORA DE MONTURAS



Código	Medida	Caja	Código Barras	€ / Ud.
41015	Única	1	8435195804225	37,86

EXPOSITOR CABEZALES



Código	Medida	Caja	Código Barras	€ / Ud.
41017	-	1	8435195822267	139,12

EJE CABEZAL / GRUPILLA / JUNTA TÓRICA



Código	Descripción	Caja	Código Barras	€ / Ud.
98083	Eje visto	25	8435195832679	0,64
98084	Eje empotrar	25	8435195832686	0,82

Código	Descripción	Caja	Código Barras	€ / Ud.
43030	Grupilla	25	8435195832693	0,12
83022	Junta tórica	25	8435195832709	0,029

MONTURA PRESIÓN CON CRUCETA



Código	Medida	Caja	Código Barras	€ / Ud.
19062	17 mm.	5	8435195832716	7,22
19063	18 mm.	5	8435195832723	7,82
19064	19 mm.	5	8435195832730	8,27
19067	22 mm.	5	8435195832747	14,29

VÁLVULA TRIANÓN



Código	Medida	Caja	Código Barras	€ / Ud.
99179	16 mm.	1	8435195832754	0,98

CABEZALES UNIVERSALES



VOLANTE OCULTO ABS

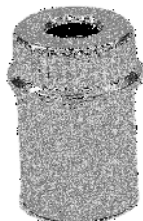

Código	Medida	Caja	Código Barras	€ / Ud.
19041	Única	25	8435195800876	0,49

VOLANTE OCULTO METÁLICO



Código	Medida	Caja	Código Barras	€ / Ud.
19031	Única	25	8435195800791	1,28

VOLANTE FACETADO



Código	Descripción	Caja	Código Barras	€ / Ud.
19034	Única	25	8435195800807	4,98

- Incluye tapa e índices.

VOLANTE 3 PUNTAS ABS



Código	Medida	Caja	Código Barras	€ / Ud.
19035	Única	25	8435195800814	2,62

VOLANTE 3 PUNTAS METÁLICO

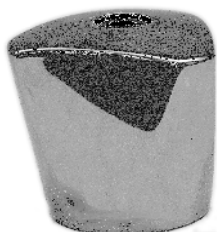

Código	Medida	Caja	Código Barras	€ / Ud.
19038	Única	25	8435195800845	2,10

VOLANTE 3 PUNTAS METÁLICO CUADRADILLO



Código	Medida	Caja	Código Barras	€ / Ud.
19053	6,5 mm. Ø	25	8435195828221	2,35

CABEZALES UNIVERSALES



ALARGADERA CABEZAL



Código	Medida	Caja	Código Barras	€ / Ud.
19030	Única	25	8435195800784	1,70

TORNILLO CABEZAL



Código	Medida	Caja	Código Barras	€ / Ud.
98018	M - 5 x 6	25	8435195822274	0,04

ÍNDICE PARA VOLANTE ABS



Código	Descripción	Caja	Código Barras	€ / Ud.
19036	Azul	25	8435195800821	0,035
19037	Rojo	25	8435195800838	0,035

ÍNDICE PARA VOLANTE METÁLICO



Código	Descripción	Caja	Código Barras	€ / Ud.
19039	Azul	25	8435195800852	0,035
19040	Rojo	25	8435195800869	0,035

CASQUILLO CUBRE MONTURAS



Código	Descripción	Caja	Código Barras	€ / Ud.
19042	Única	25	8435195800883	0,27





FLORÓN Y ANILLO CABEZAL

	Código	Medida	Caja	Código Barras	€ / Ud.
Florón	19043	Única	25	8435195800890	0,55
Anillo	29034	Única	25	8435195832761	0,085





CONEXIONES FLEXIBLES

Serie A		98
Termo "Serie Súper"		100
Batería de contador		102
Bomba de agua		103

CONEXIONES FLEXIBLES "SERIE A"



- INSTALACIONES DE AGUA SANITARIA
- LAVABOS
- BIDETS
- CONEXIONES DE GRIFERÍA



- RACORES: LATÓN
- ROSCAS: BSP 3/8" - 1/2"
- CAMPANA: ACERO INOXIDABLE
- TUBO: TUBO DE CAUCHO E.P.D.M. ATÓXICO
- MALLA: TRENZADO 7 HILOS EN ACERO INOX. AISI 304
- NORMA: UNE 53.626

Ø INT.TUBO mm.	Ø EXT.TUBO mm.	TEMPERATURA MÁXIMA	TEMPERATURA CONTÍNUA	PRESIÓN TRABAJO	PRESIÓN ROTURA	RADIO CURVATURA	CAUDAL NOMINAL
9 mm.	13 mm.	100°C	70°C	25 Kg/cm ²	100 Kg/cm ²	40 mm.	29l./min.

M 1/2" - H 3/8"

Código	Medida	Caja	Código Barras	€/ Ud.
55021	M 1/2" - H 3/8" x 15	10	8435195807226	1,69
55022	M 1/2" - H 3/8" x 20	10	8435195807233	2,25
55023	M 1/2" - H 3/8" x 25	10	8435195807240	1,97
55024	M 1/2" - H 3/8" x 30	10	8435195807257	2,11
55025	M 1/2" - H 3/8" x 35	10	8435195807264	2,99
55026	M 1/2" - H 3/8" x 40	10	8435195807271	2,20
55027	M 1/2" - H 3/8" x 45	10	8435195807288	2,29
55028	M 1/2" - H 3/8" x 50	10	8435195807295	2,69
55029	M 1/2" - H 3/8" x 60	10	8435195826135	2,92
55030	M 1/2" - H 3/8" x 100	10	8435195826142	3,79

M 3/8" - H 1/2"

Código	Medida	Caja	Código Barras	€/ Ud.
55521	M 3/8" - H 1/2" x 15	10	8435195807301	1,69
55522	M 3/8" - H 1/2" x 20	10	8435195807318	1,75
55523	M 3/8" - H 1/2" x 25	10	8435195807325	1,89
55524	M 3/8" - H 1/2" x 30	10	8435195807332	2,23
55525	M 3/8" - H 1/2" x 35	10	8435195807349	2,10
55526	M 3/8" - H 1/2" x 40	10	8435195807356	2,20
55527	M 3/8" - H 1/2" x 45	10	8435195807363	2,52
55528	M 3/8" - H 1/2" x 50	10	8435195807370	2,68
55529	M 3/8" - H 1/2" x 60	10	8435195826159	2,92
55530	M 3/8" - H 1/2" x 100	10	8435195826166	3,79

M 3/8" - H 3/8"

Código	Medida	Caja	Código Barras	€/ Ud.
56021	M 3/8" - H 3/8" x 15	10	8435195806823	1,78
56022	M 3/8" - H 3/8" x 20	10	8435195806830	1,95
56023	M 3/8" - H 3/8" x 25	10	8435195806847	1,97
56024	M 3/8" - H 3/8" x 30	10	8435195806854	2,15
56025	M 3/8" - H 3/8" x 35	10	8435195806861	2,25
56026	M 3/8" - H 3/8" x 40	10	8435195806878	2,30
56027	M 3/8" - H 3/8" x 45	10	8435195806885	2,58
56028	M 3/8" - H 3/8" x 50	10	8435195806892	2,50
56029	M 3/8" - H 3/8" x 60	10	8435195826173	2,95
56031	M 3/8" - H 3/8" x 70	10	8435195839838	3,76
56030	M 3/8" - H 3/8" x 100	10	8435195826180	3,86

CONEXIONES FLEXIBLES "SERIE A"



H 1/2" - H 1/2"

Código	Medida	Caja	Código Barras	€ / Ud.
52521	H 1/2" - H 1/2" x 15	10	8435195806984	1,87
52522	H 1/2" - H 1/2" x 20	10	8435195806991	1,94
52523	H 1/2" - H 1/2" x 25	10	8435195807004	2,15
52524	H 1/2" - H 1/2" x 30	10	8435195807011	2,29
52525	H 1/2" - H 1/2" x 35	10	8435195807028	2,39
52526	H 1/2" - H 1/2" x 40	10	8435195807035	2,48
52527	H 1/2" - H 1/2" x 45	10	8435195807042	2,29
52528	H 1/2" - H 1/2" x 50	10	8435195807059	2,67
52529	H 1/2" - H 1/2" x 60	10	8435195826050	2,92
52530	H 1/2" - H 1/2" x 100	10	8435195826067	3,89
52533	H 1/2" - H 1/2" x 150	10	8435195839630	7,28
52532	H 1/2" - H 1/2" x 200	10	8435195839623	12,16

H 3/8" - H 3/8"

Código	Medida	Caja	Código Barras	€ / Ud.
53020	H 3/8" - H 3/8" x 10	10	8435195839708	1,95
53021	H 3/8" - H 3/8" x 15	10	8435195806908	1,71
53022	H 3/8" - H 3/8" x 20	10	8435195806915	1,80
53023	H 3/8" - H 3/8" x 25	10	8435195806922	1,89
53024	H 3/8" - H 3/8" x 30	10	8435195806939	1,99
53025	H 3/8" - H 3/8" x 35	10	8435195806946	1,91
53026	H 3/8" - H 3/8" x 40	10	8435195806953	2,18
53028	H 3/8" - H 3/8" x 50	10	8435195806977	2,36
53029	H 3/8" - H 3/8" x 60	10	8435195826074	2,98
53031	H 3/8" - H 3/8" x 70	10	8435195839715	3,70
53030	H 3/8" - H 3/8" x 100	10	8435195826081	3,86
53011	H 3/8" - H 3/8" x 150	10	8435195839692	6,82
53010	H 3/8" - H 3/8" x 200	10	8435195839685	9,04

H 1/2" - H 3/8"

Código	Medida	Caja	Código Barras	€ / Ud.
53521	H 1/2" - H 3/8" x 15	10	8435195807066	1,67
53522	H 1/2" - H 3/8" x 20	10	8435195807073	1,78
53523	H 1/2" - H 3/8" x 25	10	8435195807080	2,19
53524	H 1/2" - H 3/8" x 30	10	8435195807097	2,25
53525	H 1/2" - H 3/8" x 35	10	8435195807103	2,30
53526	H 1/2" - H 3/8" x 40	10	8435195807110	2,34
53527	H 1/2" - H 3/8" x 45	10	8435195807127	2,29
53528	H 1/2" - H 3/8" x 50	10	8435195807134	2,39
53529	H 1/2" - H 3/8" x 60	10	8435195826098	2,92
53530	H 1/2" - H 3/8" x 100	10	8435195826104	3,79

M 1/2" - H 1/2"

Código	Medida	Caja	Código Barras	€ / Ud.
54021	M 1/2" - H 1/2" x 15	10	8435195807141	2,07
54022	M 1/2" - H 1/2" x 20	10	8435195807158	2,15
54023	M 1/2" - H 1/2" x 25	10	8435195807165	2,15
54024	M 1/2" - H 1/2" x 30	10	8435195807172	2,36
54025	M 1/2" - H 1/2" x 35	10	8435195807189	2,45
54026	M 1/2" - H 1/2" x 40	10	8435195807196	2,55
54027	M 1/2" - H 1/2" x 45	10	8435195807202	2,65
54028	M 1/2" - H 1/2" x 50	10	8435195807219	2,73
54029	M 1/2" - H 1/2" x 60	10	8435195826111	2,92
54031	M 1/2" - H 1/2" x 70	10	8435195839814	3,96
54030	M 1/2" - H 1/2" x 100	10	8435195826128	3,79
54009	M 1/2" - H 1/2" x 150	10	8435195839753	7,42
54008	M 1/2" - H 1/2" x 200	10	8435195839746	9,40

Nota: Se pueden fabricar conexiones sobre pedido, en cualquier medida y largo.

CONEXIONES FLEXIBLES TERMO "SERIE SÚPER"



- INSTALACIONES DE AGUA SANITARIA
- CALENTADORES
- TERMOS
- ACUMULADORES
- PLACAS SOLARES
- AIRE ACONDICIONADO

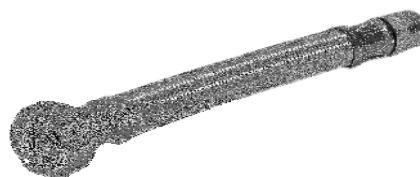

- RACORES: LATÓN
- ROSCAS: BSP 1/2" - 3/4"
- CAMPANA: ACERO INOXIDABLE
- TUBO: TUBO DE CAUCHO E.P.D.M. ATÓXICO
- MALLA: TRENZADO 7 HILOS EN ACERO INOX. AISI 304

Ø INT.TUBO mm.	Ø EXT.TUBO mm.	TEMPERATURA MÁXIMA	TEMPERATURA CONTÍNUA	PRESIÓN TRABAJO	PRESIÓN ROTURA	RADIO CURVATURA	CAUDAL NOMINAL
13 mm.	19 mm.	100°C	70°C	20 Kg/cm ²	80 Kg/cm ²	50 mm.	75l./min.

M 1/2" - H 1/2"

Código	Medida	Caja	Código Barras	€/ Ud.
56511	M 1/2" - H 1/2" x 15	10	8435195807387	3,39
56512	M 1/2" - H 1/2" x 20	10	8435195807394	4,37
56513	M 1/2" - H 1/2" x 25	10	8435195807400	4,55
56514	M 1/2" - H 1/2" x 30	10	8435195807417	4,82
56515	M 1/2" - H 1/2" x 35	10	8435195807424	4,98
56516	M 1/2" - H 1/2" x 40	10	8435195807431	5,28
56517	M 1/2" - H 1/2" x 45	10	8435195807448	4,35
56518	M 1/2" - H 1/2" x 50	10	8435195807455	5,73
56519	M 1/2" - H 1/2" x 60	10	8435195826197	7,28
56510	M 1/2" - H 1/2" x 80	10	8435195840346	7,49
56520	M 1/2" - H 1/2" x 100	10	8435195826203	8,81

H 1/2" - H 1/2"

Código	Medida	Caja	Código Barras	€/ Ud.
56521	H 1/2" - H 1/2" x 15	10	8435195807462	3,39
56522	H 1/2" - H 1/2" x 20	10	8435195807479	3,62
56523	H 1/2" - H 1/2" x 25	10	8435195807486	3,79
56524	H 1/2" - H 1/2" x 30	10	8435195807493	4,45
56525	H 1/2" - H 1/2" x 35	10	8435195807509	4,20
56526	H 1/2" - H 1/2" x 40	10	8435195807516	5,13
56527	H 1/2" - H 1/2" x 45	10	8435195807523	5,50
56528	H 1/2" - H 1/2" x 50	10	8435195807530	4,81
56529	H 1/2" - H 1/2" x 60	10	8435195826210	7,28
56530	H 1/2" - H 1/2" x 100	10	8435195826227	8,81

M 1/2" - H 3/4"

Código	Medida	Caja	Código Barras	€/ Ud.
56531	M 1/2" - H 3/4" x 15	10	8435195807547	3,76
56532	M 1/2" - H 3/4" x 20	10	8435195807554	3,99
56533	M 1/2" - H 3/4" x 25	10	8435195807561	5,54
56534	M 1/2" - H 3/4" x 30	10	8435195807578	4,52
56535	M 1/2" - H 3/4" x 35	10	8435195807585	4,73
56536	M 1/2" - H 3/4" x 40	10	8435195807592	4,95
56537	M 1/2" - H 3/4" x 45	10	8435195807608	4,80
56538	M 1/2" - H 3/4" x 50	10	8435195807615	5,87
56539	M 1/2" - H 3/4" x 60	10	8435195826234	7,80
56540	M 1/2" - H 3/4" x 100	10	8435195826241	8,95

CONEXIONES FLEXIBLES TERMO "SERIE SÚPER"



H 1/2" - H 3/4"

Código	Medida	Caja	Código Barras	€ / Ud.
56541	H 1/2" - H 3/4" x 15	10	8435195807622	3,76
56542	H 1/2" - H 3/4" x 20	10	8435195807639	3,99
56543	H 1/2" - H 3/4" x 25	10	8435195807646	4,16
56544	H 1/2" - H 3/4" x 30	10	8435195807653	4,56
56545	H 1/2" - H 3/4" x 35	10	8435195807660	4,48
56546	H 1/2" - H 3/4" x 40	10	8435195807677	4,64
56547	H 1/2" - H 3/4" x 45	10	8435195807684	4,80
56548	H 1/2" - H 3/4" x 50	10	8435195807691	5,98
56549	H 1/2" - H 3/4" x 60	10	8435195826258	7,80
56550	H 1/2" - H 3/4" x 100	10	8435195826265	8,95

M 3/4" - H 3/4"

Código	Medida	Caja	Código Barras	€ / Ud.
56551	M 3/4" - H 3/4" x 15	10	8435195807707	3,76
56552	M 3/4" - H 3/4" x 20	10	8435195807714	4,59
56553	M 3/4" - H 3/4" x 25	10	8435195807721	4,92
56554	M 3/4" - H 3/4" x 30	10	8435195807738	6,27
56555	M 3/4" - H 3/4" x 35	10	8435195807745	5,22
56556	M 3/4" - H 3/4" x 40	10	8435195807752	6,69
56557	M 3/4" - H 3/4" x 45	10	8435195807769	6,92
56558	M 3/4" - H 3/4" x 50	10	8435195807776	7,13
56559	M 3/4" - H 3/4" x 60	10	8435195826272	7,80
56560	M 3/4" - H 3/4" x 100	10	8435195826289	9,78

M 3/4" - H 1/2"

Código	Medida	Caja	Código Barras	€ / Ud.
56561	M 3/4" - H 1/2" x 15	10	8435195807783	3,76
56562	M 3/4" - H 1/2" x 20	10	8435195807790	3,99
56563	M 3/4" - H 1/2" x 25	10	8435195807806	4,16
56564	M 3/4" - H 1/2" x 30	10	8435195807813	4,29
56565	M 3/4" - H 1/2" x 35	10	8435195807820	4,48
56566	M 3/4" - H 1/2" x 40	10	8435195807837	4,87
56567	M 3/4" - H 1/2" x 45	10	8435195807844	4,80
56568	M 3/4" - H 1/2" x 50	10	8435195807851	4,99
56569	M 3/4" - H 1/2" x 60	10	8435195826296	7,80
56570	M 3/4" - H 1/2" x 100	10	8435195826302	8,95

H 3/4" - H 3/4"

Código	Medida	Caja	Código Barras	€ / Ud.
56571	H 3/4" - H 3/4" x 15	10	8435195807868	3,76
56572	H 3/4" - H 3/4" x 20	10	8435195807875	5,23
56573	H 3/4" - H 3/4" x 25	10	8435195807882	5,70
56574	H 3/4" - H 3/4" x 30	10	8435195807899	5,92
56575	H 3/4" - H 3/4" x 35	10	8435195807905	6,15
56576	H 3/4" - H 3/4" x 40	10	8435195807912	6,38
56577	H 3/4" - H 3/4" x 45	10	8435195807929	6,59
56578	H 3/4" - H 3/4" x 50	10	8435195807936	6,83
56579	H 3/4" - H 3/4" x 60	10	8435195826319	7,80
56580	H 3/4" - H 3/4" x 100	10	8435195826326	8,95

Nota: Se pueden fabricar conexiones sobre pedido, en cualquier medida y largo.

CONEXIONES FLEXIBLES BATERÍAS CONTADOR



- BATERÍAS DE CONTADOR
- ACOMETIDAS
- CALEFACCIÓN
- AIRE ACONDICIONADO



- RACORES: LATÓN
- ROSCAS: BSP 3/4" - 1" - 1 1/4"
- CAMPANA: ACERO INOXIDABLE
- TUBO: TUBO DE CAUCHO E.P.D.M. ATÓXICO
- MALLA: TRENZADO EN ACERO INOX. AISI 304

CONEXIÓN	Ø INT.TUBO mm.	Ø EXT.TUBO mm.	TEMPERATURA MÁXIMA	TEMPERATURA CONTÍNUA	PRESIÓN TRABAJO	PRESIÓN ROTURA	RADIO CURVATURA	CAUDAL NOMINAL
3/4"	19 mm.	28 mm.	90°C	70°C	15 Kg/cm ²	60 Kg/cm ²	80 mm.	150 l./min.
1"	25 mm.	35 mm.	90°C	70°C	10 Kg/cm ²	40 Kg/cm ²	130 mm.	250 l./min.
1 1/4"	30 mm.	40 mm.	90°C	70°C	10 Kg/cm ²	40 Kg/cm ²	200 mm.	400l./min.

M 3/4" - H 3/4"

Código	Medida	Caja	Código Barras	€ / Ud.
56102	M 3/4" - H 3/4" x 30	1	8435195823431	11,92
56104	M 3/4" - H 3/4" x 40	1	8435195823448	12,08
56106	M 3/4" - H 3/4" x 50	1	8435195823455	12,65
56108	M 3/4" - H 3/4" x 60	1	8435195823462	13,95
56110	M 3/4" - H 3/4" x 80	1	8435195823479	18,01
56112	M 3/4" - H 3/4" x 100	1	8435195823486	20,41

M 1" - H 1"

Código	Medida	Caja	Código Barras	€ / Ud.
56117	M 1" - H 1" x 30	1	8435195823493	18,12
56119	M 1" - H 1" x 40	1	8435195823509	18,88
56121	M 1" - H 1" x 50	1	8435195823516	20,55
56123	M 1" - H 1" x 60	1	8435195823523	21,19
56125	M 1" - H 1" x 80	1	8435195823530	26,29
56127	M 1" - H 1" x 100	1	8435195823547	30,06

M 1 1/4" - H 1 1/4"

Código	Medida	Caja	Código Barras	€ / Ud.
56131	M 1 1/4" - H 1 1/4" x 30	1	8435195823554	28,24
56133	M 1 1/4" - H 1 1/4" x 40	1	8435195823561	31,12
56135	M 1 1/4" - H 1 1/4" x 50	1	8435195823578	34,05
56137	M 1 1/4" - H 1 1/4" x 60	1	8435195823585	38,43
56139	M 1 1/4" - H 1 1/4" x 80	1	8435195823592	46,96
56141	M 1 1/4" - H 1 1/4" x 100	1	8435195823608	53,44

Nota: Se pueden fabricar conexiones sobre pedido, en cualquier medida y largo.

CONEXIONES FLEXIBLES PARA BOMBA DE AGUA



- BOMBAS DE AGUA
- ACOMETIDAS INSTALACIONES INDUSTRIALES

- RACORES: LATÓN
- ROSCAS: BSP 3/4" - 1" - 1 1/4" - 1 1/2" - 2"
- CAMPANA: ACERO GALVANIZADO
- TUBO: TUBO DE CAUCHO E.P.D.M. ATÓXICO
- MALLA: TRENZADO EN ACERO GALVANIZADO

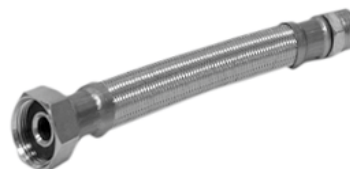

Apartir de 1" los tubos incorporan un refuerzo de trenzado intermedio.

CONEXIÓN	Ø INT.TUBO mm.	Ø EXT.TUBO mm.	TEMPERATURA MÁXIMA	TEMPERATURA CONTÍNUA	PRESIÓN TRABAJO	PRESIÓN ROTURA	RADIO CURVATURA	CAUDAL NOMINAL
3/4"	19 mm.	28 mm.	90°C	70°C	15 Kg/cm ²	60 Kg/cm ²	80 mm.	150 l./min.
1"	25 mm.	35 mm.	90°C	70°C	12 Kg/cm ²	40 Kg/cm ²	130 mm.	250 l./min.
1 1/4"	30 mm.	40 mm.	90°C	70°C	10 Kg/cm ²	30 Kg/cm ²	200 mm.	400l./min.
1 1/2"	40 mm.	52 mm.	90°C	70°C	8 Kg/cm ²	25 Kg/cm ²	230 mm.	750 l./min.
2"	50 mm.	62 mm.	90°C	70°C	7 Kg/cm ²	20 Kg/cm ²	300 mm.	1250 l./min.

M 3/4" - H 3/4"

Código	Medida	Caja	Código Barras	€ / Ud.
50104	M 3/4" - H 3/4" x 40	1	8435195826333	12,40
50106	M 3/4" - H 3/4" x 50	1	8435195826340	12,95
50108	M 3/4" - H 3/4" x 60	1	8435195826357	14,68

H 3/4" - H 3/4"

Código	Medida	Caja	Código Barras	€ / Ud.
50116	H 3/4" - H 3/4" x 40	1	8435195826364	11,60
50118	H 3/4" - H 3/4" x 50	1	8435195826371	12,92
50120	H 3/4" - H 3/4" x 60	1	8435195826388	14,60

M 1" - H 1"

Código	Medida	Caja	Código Barras	€ / Ud.
50126	M 1" - H 1" x 40	1	8435195826395	20,18
50128	M 1" - H 1" x 50	1	8435195826401	21,64
50130	M 1" - H 1" x 60	1	8435195826418	22,95

H 1" - H 1"

Código	Medida	Caja	Código Barras	€ / Ud.
50137	H 1" - H 1" x 40	1	8435195826425	19,92
50139	H 1" - H 1" x 50	1	8435195826432	23,58
50140	H 1" - H 1" x 60	1	8435195826449	22,95

M 1 1/4" - H 1 1/4"

Código	Medida	Caja	Código Barras	€ / Ud.
50148	M 1 1/4" - H 1 1/4" x 40	1	8435195826456	32,68
50150	M 1 1/4" - H 1 1/4" x 50	1	8435195826463	35,70
50151	M 1 1/4" - H 1 1/4" x 60	1	8435195826470	50,25

CONEXIONES FLEXIBLES PARA BOMBA DE AGUA



H 1 1/4" - H 1 1/4"

Código	Medida	Caja	Código Barras	€ / Ud.
50163	H 1 1/4" - H 1 1/4" x 40	1	8435195826487	45,99
50165	H 1 1/4" - H 1 1/4" x 50	1	8435195826494	50,54
50167	H 1 1/4" - H 1 1/4" x 60	1	8435195826500	55,05

M 1 1/2" - H 1 1/2"

Código	Medida	Caja	Código Barras	€ / Ud.
50174	M 1 1/2" - H 1 1/2" x 40	1	8435195826517	61,88
50176	M 1 1/2" - H 1 1/2" x 50	1	8435195826524	67,72
50178	M 1 1/2" - H 1 1/2" x 60	1	8435195826531	73,53

H 1 1/2" - H 1 1/2"

Código	Medida	Caja	Código Barras	€ / Ud.
50188	H 1 1/2" - H 1 1/2" x 40	1	8435195826548	61,88
50190	H 1 1/2" - H 1 1/2" x 50	1	8435195826555	67,72
50192	H 1 1/2" - H 1 1/2" x 60	1	8435195826562	73,53

M 2" - H 2"

Código	Medida	Caja	Código Barras	€ / Ud.
50203	M 2" - H 2" x 40	1	8435195826579	79,68
50205	M 2" - H 2" x 50	1	8435195826586	78,37
50207	M 2" - H 2" x 60	1	8435195826593	85,54

H 2" - H 2"

Código	Medida	Caja	Código Barras	€ / Ud.
50218	H 2" - H 2" x 40	1	8435195826609	73,69
50220	H 2" - H 2" x 50	1	8435195826616	79,14
50222	H 2" - H 2" x 60	1	8435195826623	84,58

Nota: Se pueden fabricar conexiones sobre pedido, en cualquier medida y largo.



CONEXIONES PARA LAVADORA

Conexiones lavadora / lavavajillas



106

CONEXIONES PARA LAVADORA



TOMA ENTRADA LAVADORA / LAVAVAJILLAS tuerca nylon



Código	Medida	Caja	Código Barras	€ / Ud.
52006	1,5 m.	10	8435195806663	3,20
52007	2 m.	10	8435195806670	4,57
52014	3 m.	10	8435195806687	6,64

TOMA ENTRADA LAVADORA / LAVAVAJILLAS tuerca latón



Código	Medida	Caja	Código Barras	€ / Ud.
52008	1,5 m.	10	8435195806694	4,95
52009	2 m.	10	8435195806700	6,94
52013	3 m.	10	8435195806717	6,56

SALIDA DE LAVADORA / LAVAVAJILLAS



Código	Medida	Caja	Código Barras	€ / Ud.
52010	1,5 m.	10	8435195806724	2,30
52012	2 m.	10	8435195806748	2,39
52015	3 m.	10	8435195806755	3,90

SALIDA DE LAVADORA / LAVAVAJILLAS EXTENSIBLE

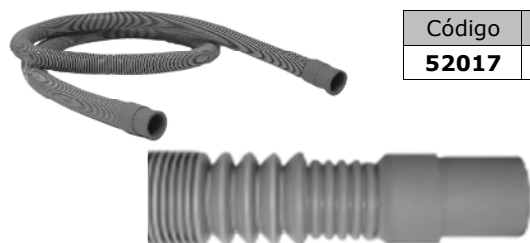

Código	Medida	Caja	Código Barras	€ / Ud.
52017	0,60 a 1,60 m.	3,72	8435195821307	3,72

CURVA SALIDA LAVADORA / LAVAVAJILLAS



Código	Medida	Caja	Código Barras	€ / Ud.
52011	única	10	8435195806731	0,33



VÁLVULAS ESFERA EMPOTRAR Y ACCESORIOS

Válvulas esfera empotrar



108

Accesorios



109

VÁLVULAS ESFERA EMPOTRAR



VÁLVULA ESFERA SERIE BOSTON SOLDAR

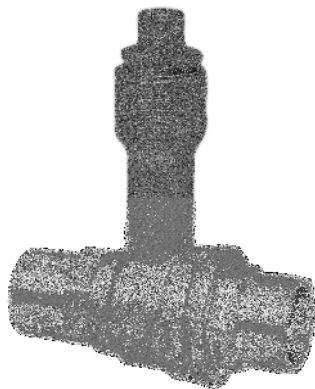

Código	Medida	Caja	Código Barras	€ / Ud.
27015	15 x 15	10	8435195802573	8,98
27018	18 x 18	10	8435195802580	7,26
27022	22 x 22	10	8435195802597	15,40
27028	28 x 28	10	8435195802603	12,62

- Válvula de esfera empotrar SOLDAR.
- PN 16 Paso total.
- Fabricada en latón UNE-EN 12165.
- Extremos para soldar H-H.
- ISO 228/1. Temperatura máxima 150°C.

VÁLVULA ESFERA SERIE BOSTON ROSCAR

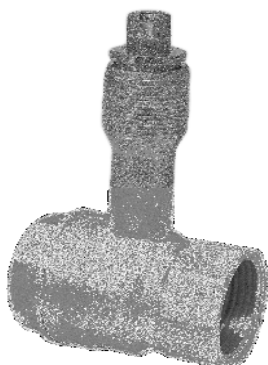

Código	Medida	Caja	Código Barras	€ / Ud.
27503	1/2" X 1/2"	10	8435195802610	6,34
27504	3/4" X 3/4"	10	8435195802627	7,85
27505	1" X 1"	10	8435195802634	12,62

- Válvula de esfera empotrar ROSCAR.
- PN 16 Paso total.
- Fabricada en latón UNE-EN 12165.
- Extremos roscados H-H.
- ISO 228/1. Temperatura máxima 150°C.

VÁLVULA ESFERA SERIE BOSTON MULTICAPA

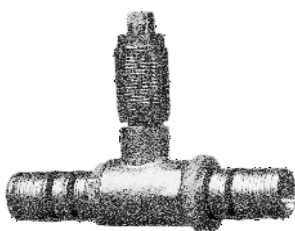

Código	Medida	Caja	Código Barras	€ / Ud.
27616	Ø 16	10	8435195820157	7,43
27620	Ø 20	10	8435195820164	8,07
27625	Ø 25	10	8435195820171	8,99
27632	Ø 32	10	8435195820188	13,10

- Válvula empotrar tubería PEX y MULTICAPA con casquillos.
- PN 25 Paso total.
- Fabricada en latón cromado según UNE-EN 12165.
- Juntas E.P.D.M.
- Temperatura máxima 110°C.

VÁLVULAS ESFERA EMPOTRAR

Accesorios



MANDO Y FLORÓN METÁLICO "MODELO MERCURI"

Código	Medida	Caja	Código Barras	€ / Ud.
28001	Única	50	8435195802658	4,15

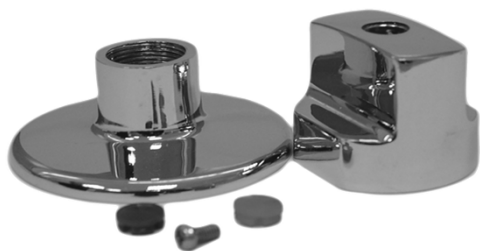

MANDO Y FLORÓN PALANCA METÁLICO "MODELO ONDA"

Código	Medida	Caja	Código Barras	€ / Ud.
29003	Única	50	8435195802665	4,58



MANDO Y FLORÓN OCULTO METÁLICO "MODELO POLARE"

Código	Medida	Caja	Código Barras	€ / Ud.
29504	Única	50	8435195802672	2,95
29506	Con cuadradillo	50	8435195826647	2,45

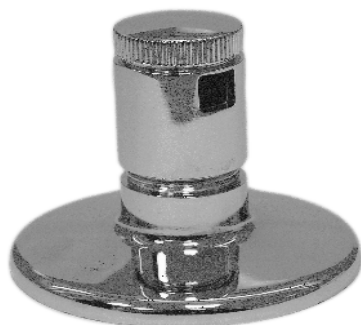

- Compatible con válvulas empotrar Uponor y multicapa.

ALARGADERA VÁLVULA EMPOTRAR SERIE BOSTON



Código	Medida	Caja	Código Barras	€ / Ud.
19032	Única	25	8435195847505	1,57



- Incluye el tornillo.



VÁLVULAS DE CONTROL

Soldar		112
Roscar		113
Recambios		114

VÁLVULAS DE CONTROL SOLDAR



VÁLVULA CONTROL SOLDAR VOLANTE 3 PUNTAS ABS



	Código	Medida	Caja	Código Barras	€ / Ud.
Cuello largo	15015	15 x 15	72	8435195800180	8,96
	15018	18 x 18	72	8435195800197	9,35
	15022	22 x 22	72	8435195800203	9,91
	15028	28 x 28	36	8435195800210	18,60

	Código	Medida	Caja	Código Barras	€ / Ud.
Cuello corto	15122	22 x 22	72	8435195800241	8,92

VÁLVULA CONTROL SOLDAR VOLANTE 3 PUNTAS METÁLICO



	Código	Medida	Caja	Código Barras	€ / Ud.
Cuello largo	15515	15 x 15	72	8435195800258	8,25
	15518	18 x 18	72	8435195800265	8,62
	15522	22 x 22	72	8435195800272	8,96
	15528	28 x 28	36	8435195800289	17,10

	Código	Medida	Caja	Código Barras	€ / Ud.
Cuello corto	15622	22 x 22	72	8435195800319	8,28

VÁLVULA CONTROL SOLDAR VOLANTE FACETADO METÁLICO

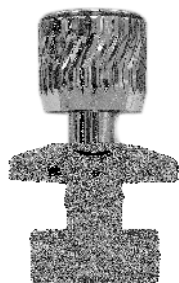

	Código	Medida	Caja	Código Barras	€ / Ud.
Cuello largo	16015	15 x 15	72	8435195800326	11,74
	16018	18 x 18	72	8435195800333	12,17
	16022	22 x 22	72	8435195800340	12,51
	16028	28 x 28	36	8435195800357	20,89

	Código	Medida	Caja	Código Barras	€ / Ud.
Cuello corto	16122	22 x 22	72	8435195800388	11,45

VÁLVULA CONTROL SOLDAR VOLANTE OCULTO ABS



	Código	Medida	Caja	Código Barras	€ / Ud.
Cuello largo	16515	15 x 15	72	8435195800395	6,74
	16518	18 x 18	72	8435195800401	6,98
	16522	22 x 22	72	8435195800418	7,15
	16528	28 x 28	36	8435195800425	15,25

	Código	Medida	Caja	Código Barras	€ / Ud.
Cuello corto	16622	22 x 22	72	8435195800456	6,55

VÁLVULA CONTROL SOLDAR VOLANTE OCULTO METÁLICO



	Código	Medida	Caja	Código Barras	€ / Ud.
Cuello largo	16715	15 x 15	72	8435195800463	7,77
	16718	18 x 18	72	8435195800470	8,02
	16722	22 x 22	72	8435195800487	8,27
	16728	28 x 28	36	8435195800494	16,69

	Código	Medida	Caja	Código Barras	€ / Ud.
Cuello corto	16822	22 x 22	72	8435195800524	7,55

VÁLVULAS DE CONTROL ROSCAR



VÁLVULA CONTROL ROSCAR VOLANTE 3 PUNTAS ABS



Código	Medida	Caja	Código Barras	€ / Ud.
17002	H 1/2" x H 1/2"	36	8435195800531	9,98
17004	H 3/4" x H 3/4"	36	8435195800548	11,70

VÁLVULA CONTROL ROSCAR VOLANTE 3 PUNTAS METÁLICO

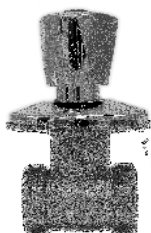

Código	Medida	Caja	Código Barras	€ / Ud.
17502	H 1/2" x H 1/2"	36	8435195800555	11,17
17504	H 3/4" x H 3/4"	36	8435195800562	10,79

VÁLVULA CONTROL ROSCAR VOLANTE FACETADO METÁLICO



Código	Medida	Caja	Código Barras	€ / Ud.
18002	H 1/2" x H 1/2"	36	8435195800579	13,90
18004	H 3/4" x H 3/4"	36	8435195800586	14,86

VÁLVULA CONTROL ROSCAR VOLANTE OCULTO ABS



Código	Medida	Caja	Código Barras	€ / Ud.
18502	H 1/2" x H 1/2"	36	8435195800593	9,56
18504	H 3/4" x H 3/4"	36	8435195800609	9,70

VÁLVULA DUCHA PISCINAS VOLANTE FACETADO METÁLICO



	Código	Medida	Caja	Código Barras	€ / Ud.
Cuello corto	18507	H 1/2" x H 1/2"	36	8435195800623	11,34

VÁLVULA DUCHA PISCINAS VOLANTE OCULTO METÁLICO



	Código	Medida	Caja	Código Barras	€ / Ud.
Cuello largo	18508	H 1/2" x H 1/2"	36	8435195800630	10,60

	Código	Medida	Caja	Código Barras	€ / Ud.
Cuello corto	18511	H 1/2" x H 1/2"	36	8435195800647	7,70

RECAMBIOS VÁLVULAS CONTROL



CUERPO VÁLVULA CONTROL



	Código	Medida	Caja	Código Barras	€ / Ud.
Cuello largo	18615	15 x 15 Ø soldar	10	8435195800654	3,38
	18618	18 x 18 Ø soldar	10	8435195800661	3,69
	18622	22 x 22 Ø soldar	10	8435195800678	3,79
	18628	28 x 28 Ø soldar	10	8435195800685	11,98
	18629	H 1/2" x H 1/2" roscar	10	8435195800692	3,59
	18630	H 3/4" x H 3/4" roscar	10	8435195800708	5,26

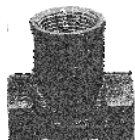

	Código	Medida	Caja	Código Barras	€ / Ud.
Cuello corto	19022	22 x 22 Ø soldar	10	8435195800739	2,98
	18631	H 1/2" x H 1/2" roscar	10	8435195834758	3,45

MONTURA VÁLVULA CONTROL



	Código	Medida	Caja	Código Barras	€ / Ud.
Empotrar	19023	19/150	36	8435195800746	3,45
	19024	22/150	36	8435195800753	3,78
	19028	1/2"	36	8435195834819	3,63



	Código	Medida	Caja	Código Barras	€ / Ud.
Oculta	19025	19/150	36	8435195800760	3,30
	19026	22/150	36	8435195800777	3,52
	19017	1/2"	36	8435195847864	3,54

VOLANTE OCULTO ABS



Código	Medida	Caja	Código Barras	€ / Ud.
19041	Única	25	8435195800876	0,49

VOLANTE OCULTO METÁLICO



Código	Medida	Caja	Código Barras	€ / Ud.
19031	Única	25	8435195800791	1,28

VOLANTE FACETADO



Código	Medida	Caja	Código Barras	€ / Ud.
19034	Única	25	8435195800807	4,98

• Incluye tapa e índices.

VOLANTE 3 PUNTAS ABS



Código	Medida	Caja	Código Barras	€ / Ud.
19035	Única	25	8435195800814	2,62

VOLANTE 3 PUNTAS METÁLICO



Código	Medida	Caja	Código Barras	€ / Ud.
19038	Única	25	8435195800845	2,10

VOLANTE 3 PUNTAS METÁLICO CUADRADILLO



Código	Medida	Caja	Código Barras	€ / Ud.
19053	6,5 mm. Ø	25	8435195828221	2,35

RECAMBIOS VÁLVULAS CONTROL



ALARGADERA CABEZAL



Código	Medida	Caja	Código Barras	€ / Ud.
19030	Única	25	8435195800784	1,70

TORNILLO CABEZAL



Código	Medida	Caja	Código Barras	€ / Ud.
98018	M - 5 x 6	25	8435195822274	0,04

ÍNDICE PARA VOLANTE ABS



Código	Descripción	Caja	Código Barras	€ / Ud.
19036	Azul	25	8435195800821	0,035
19037	Rojo	25	8435195800838	0,035

ÍNDICE PARA VOLANTE METÁLICO



Código	Descripción	Caja	Código Barras	€ / Ud.
19039	Azul	25	8435195800852	0,035
19040	Rojo	25	8435195800869	0,035

CASQUILLO CUBRE MONTURAS



Código	Medida	Caja	Código Barras	€ / Ud.
19042	Única	25	8435195800883	0,27





FLORÓN Y ANILLO

	Código	Medida	Caja	Código Barras	€ / Ud.
Florón	19043	Única	25	8435195800890	0,55
Anillo	29034	Única	25	8435195832761	0,085





VÁLVULAS DE ESFERA

Válvulas esfera palanca		118
Válvulas esfera cuadradillo		119
Válvulas esfera palomilla		120
Válvulas esfera mini		121

VÁLVULAS DE ESFERA

Mando palanca



- PN30. Rosca Gas, ISO 228/1.
- Temperatura máxima 120°C.
- Prensa estopa con guarnición de PTFE.
- Maneta de acero con PVC azul/rojo.

VÁLVULA ESFERA H-H PALANCA ACERO



Código	Medida	Caja	Código Barras	€ / Ud.
20011	1/4"	100	8435195800975	4,75
20012	3/8"	100	8435195800982	3,59
20013	1/2"	100	8435195800999	5,58
20014	3/4"	100	8435195801002	7,35
20015	1"	50	8435195801019	12,25
20016	1 1/4"	28	8435195801026	15,80
20017	1 1/2"	16	8435195801033	25,00
20018	2"	8	8435195801040	41,95
20019	2 1/2"	4	8435195801057	99,75
20020	3"	2	8435195801064	139,75
20021	4"	2	8435195801071	139,75

VÁLVULA ESFERA M-H PALANCA ACERO



Código	Medida	Caja	Código Barras	€ / Ud.
22005	3/8"	100	8435195801125	3,94
22006	1/2"	100	8435195801132	5,15
22007	3/4"	50	8435195801149	7,18
22008	1"	50	8435195801156	9,86

VÁLVULA ESFERA M-M PALANCA ACERO



Código	Medida	Caja	Código Barras	€ / Ud.
22524	3/8"	10	8435195826654	5,26
22508	1/2"	10	8435195822199	6,89
22509	3/4"	10	8435195822205	8,25
22510	1"	10	8435195822212	13,91

VÁLVULA ESFERA SOLDAR PALANCA ACERO



Código	Medida	Caja	Código Barras	€ / Ud.
22115	15 x 15 Ø	100	8435195801163	5,80
22118	18 x 18 Ø	100	8435195801170	6,94
22122	22 x 22 Ø	60	8435195801187	7,98
22128	28 x 28 Ø	50	8435195801194	16,97
22135	35 x 35 Ø	10	8435195820096	20,88
22142	42 x 42 Ø	10	8435195820102	33,70
22154	54 x 54 Ø	10	8435195820119	54,72

VÁLVULA ESFERA POLIPROPILENO H-H- PALANCA ALUMINIO



Código	Medida	Caja	Código Barras	€ / Ud.
20003	1/2"	20	8435195800913	7,19
20004	3/4"	20	8435195800920	9,42
20005	1"	10	8435195800937	12,39
20006	1 1/4"	5	8435195800944	20,95
20007	1 1/2"	5	8435195800951	31,88
20008	2"	2	8435195800968	46,19

VÁLVULAS DE ESFERA

Mando cuadradillo



- PN30. Rosca Gas, ISO 228/1.
- Temperatura máxima 120°C.
- Prensa estopa con guarnición de PTFE.

VÁLVULA ESFERA H-H CUADRADILLO "MALLORCA"



Código	Medida	Caja	Código Barras	€ / Ud.
22603	1/2" - 14	20	8435195801309	6,20
22604	3/4" - 14	20	8435195801316	8,22
22605	1" - 16	20	8435195801323	12,95
22606	1 1/4" - 16	20	8435195801330	19,30
22607	1 1/2" - 18	20	8435195801347	29,72
22608	2" - 18	20	8435195801354	42,16

VÁLVULA ESFERA M-H CUADRADILLO "MALLORCA"



Código	Medida	Caja	Código Barras	€ / Ud.
22612	1/2" - 14	10	8435195801361	4,95
22613	3/4" - 14	10	8435195801378	6,85
22614	1" - 16	5	8435195801385	10,12

VÁLVULA ESFERA ESCUADRA CUADRADILLO



	Código	Medida	Caja	Código Barras	€ / Ud.
M - H	22601	1/2" - 14	10	8435195801286	7,680
	Código	Medida	Caja	Código Barras	€ / Ud.
M - M	22602	1/2" - 14	10	8435195801293	7,690

VÁLVULA ESFERA H-H CUADRADILLO



Código	Medida	Caja	Código Barras	€ / Ud.
22621	1/2" - 18	20	8435195801392	7,310
22622	3/4" - 18	20	8435195801408	9,760
22623	1" - 18	10	8435195801415	20,980
22624	1 1/4" - 25	5	8435195801422	24,930
22625	1 1/2" - 25	5	8435195801439	35,430
22626	2" - 25	5	8435195801446	57,320
22627	2 1/2" - 26	2	8435195820126	109,100
22628	3" - 26	2	8435195820133	162,440
22629	4" - 36	2	8435195820140	271,300

VÁLVULA ESFERA M-H CUADRADILLO

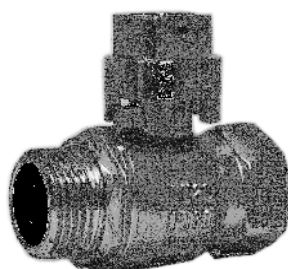

Código	Medida	Caja	Código Barras	€ / Ud.
22630	1/2" - 18	20	8435195801453	5,60
22631	3/4" - 18	20	8435195801460	8,60
22632	1" - 18	10	8435195801477	12,53

VÁLVULAS DE ESFERA

Mando palomilla



- PN30. Rosca Gas, ISO 228/1.
- Temperatura máxima 120°C.
- Prensa estopa con guarnición de PTFE.
- Maneta palomilla de aluminio roja o azul.

VÁLVULA ESFERA H-H PALOMILLA



Código	Medida	Caja	Código Barras	€ / Ud.
20501	1/4"	100	8435195826661	4,58
20502	3/8"	100	8435195801088	3,84
20503	1/2"	100	8435195801095	4,65
20504	3/4"	50	8435195801101	7,18
20505	1"	50	8435195801118	10,93

VÁLVULA ESFERA M-H PALOMILLA

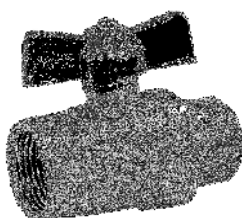

Código	Medida	Caja	Código Barras	€ / Ud.
22501	1/4"	100	8435195826678	5,95
22502	3/8"	100	8435195826685	4,45
22503	1/2"	100	8435195801200	5,60
22504	3/4"	60	8435195801217	8,57
22505	1"	50	8435195801224	12,59

VÁLVULA ESFERA M-M PALOMILLA



Código	Medida	Caja	Código Barras	€ / Ud.
22511	1/2"	10	8435195822229	5,35
22512	3/4"	10	8435195822236	8,25
22517	1"	10	8435195822243	13,36

VÁLVULA ESFERA ESCUADRA PALOMILLA



	Código	Medida	Caja	Código Barras	€ / Ud.
M - H	22506	1/2" x 1/2"	10	8435195801231	10,45
	Código	Medida	Caja	Código Barras	€ / Ud.
M - M	22507	1/2" x 1/2"	10	8435195801248	6,91

- Maneta palomilla de aluminio amarilla.

VÁLVULA ESFERA SOLDAR PALOMILLA



Código	Medida	Caja	Código Barras	€ / Ud.
22515	15 x 15 Ø	100	8435195801255	4,19
22518	18 x 18 Ø	100	8435195801262	4,22
22522	22 x 22 Ø	60	8435195801279	7,42

VÁLVULAS DE ESFERA



• PN16. Rosca Gas, ISO 228/1.

• Temperatura máxima 100°C.

VÁLVULA ESFERA MINI H-H



Código	Medida	Caja	Código Barras	€ / Ud.
23001	1/4"	20	8435195826692	3,96
23002	3/8"	20	8435195801484	3,63
23003	1/2"	20	8435195801491	3,71
23004	3/4"	20	8435195801507	8,58

VÁLVULA ESFERA MINI M-H

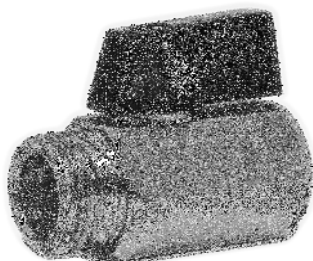

Código	Medida	Caja	Código Barras	€ / Ud.
23501	1/4"	20	8435195801514	3,43
23502	3/8"	20	8435195801521	3,30
23503	1/2"	20	8435195801538	3,89
23504	3/4"	20	8435195801545	5,99



GRIFOS CURVOS Y ACCESORIOS

Grifo curvo esfera		124
Grifo curvo candado		125
Grifo curvo polipropileno y antihielo		125
Racor, enchufe, unión y boquilla adaptables		126

GRIFOS CURVOS



GRIFO CURVO ESFERA



Código	Medida	Caja	Código Barras	€ / Ud.
24506	1/2" x 3/4"	100	8435195801651	5,43
24507	3/4" x 1"	50	8435195801668	7,64
24519	3/4" x 3/4"	20	8435195832778	10,99
24508	1" x 1 1/4"	20	8435195801675	13,00
24528	1" x 1"	20	8435195832785	17,20

- PN16.
- Latón EN 12165 cromado.
- Temperatura máxima 90°C.
- Prensa estopa con guarnición de PTFE.
- Maneta de acero con PVC azul.
- Racor 2 piezas conexión manguera.
- Rompe chorros en Nylon.

GRIFO CURVO ESFERA RACOR RÁPIDO MANGUERA



Código	Medida	Caja	Código Barras	€ / Ud.
24522	1/2" x 3/4"	40	8435195822281	7,25
24523	3/4" x 1"	20	8435195822298	10,59
24524	3/4" x 3/4"	10	8435195822304	14,98

- PN16.
- Latón EN 12165 cromado.
- Temperatura máxima 90°C.
- Prensa estopa con guarnición de PTFE.
- Maneta de acero con PVC azul.
- Racor rápido conexión manguera.

GRIFO CURVO ESFERA SALIDA DOBLE RACOR RÁPIDO MANGUERA



Código	Medida	Caja	Código Barras	€ / Ud.
24509	1/2" x 3/4"	100	8435195825183	11,98

- PN16.
- Latón EN 12165 cromado.
- Temperatura máxima 90°C.
- Prensa estopa con guarnición de PTFE.
- Maneta de acero con PVC azul.
- Racor rápido conexión manguera.

GRIFOS CURVOS



GRIFO CURVO PARA CANDADO



Código	Medida	Caja	Código Barras	€ / Ud.
24525	1/2" x 3/4"	40	8435195822250	7,18

- PN16.
- Latón EN 12165 cromado.
- Temperatura máxima 90°C.
- Prensa estopa con guarnición de PTFE.
- Maneta de acero con PVC rojo.
- Racor 2 piezas conexión manguera.

GRIFO CURVO POLIPROPILENO



Código	Medida	Caja	Código Barras	€ / Ud.
24503	1/2" x 3/4"	40	8435195801620	11,69
24504	3/4" x 1"	25	8435195801637	20,95
24505	1" x 1 1/4"	15	8435195801644	27,75

- PN16.
- Temperatura: de 0°C. a 75°C.
- Prensa estopa con guarnición de PTFE con junta tórica NBR.
- Maneta de aluminio con PVC rojo.
- Conexión manguera.
- No adecuado para gas.

GRIFO CURVO ANTIHIELO NÓRDICO



Código	Medida	Caja	Código Barras	€ / Ud.
24500	1/2" x 3/4"	40	8435195820065	15,45
24501	3/4" x 1"	25	8435195820072	23,55
24502	1" x 1 1/4"	15	8435195820089	34,32

- PN16.
- Temperatura: de -20°C. a +75°C.
- Prensa estopa con guarnición de PTFE con junta tórica NBR.
- Maneta de aluminio con PVC azul.
- Conexión manguera.
- No adecuado para gas.
- Resistente al hielo.

GRIFOS CURVOS

Accesorios



RACOR DOS PIEZAS NÍQUEL



Código	Medida	Caja	Código Barras	€ / Ud.
71504	1/2" x 3/4"	25	8435195811681	0,98
71505	3/4" x 1"	25	8435195811698	1,79
71507	1" x 1"	25	8435195826708	2,65
71506	1" x 1 1/4"	25	8435195811704	4,71

RACOR HEMBRA SISTEMA ANCLAJE ADAPTABLE S/COLOR



Código	Medida	Caja	Código Barras	€ / Ud.
24541	3/4"	10	8435195822311	2,17
24542	1"	10	8435195822328	5,19

RACOR HEMBRA SISTEMA ANCLAJE ADAPTABLE NÍQUEL



Código	Medida	Caja	Código Barras	€ / Ud.
24544	3/4"	10	8435195822335	2,39
24545	1"	10	8435195822342	4,25

ENCHUFE ADAPTABLE A MANGUERA S/COLOR



Código	Medida	Caja	Código Barras	€ / Ud.
24546	1/2"	10	8435195828023	9,70
24547	3/4"	10	8435195822359	11,58

UNIÓN MANGUERA - MANGUERA S/COLOR



Código	Medida	Caja	Código Barras	€ / Ud.
24549	1/2"	10	8435195828030	6,62
24550	3/4"	10	8435195822373	16,72

BOQUILLA GRADUABLE CONTROL DE SALIDA S/COLOR



Código	Medida	Caja	Código Barras	€ / Ud.
24553	9,5 Ø	10	8435195822397	8,85

• Adaptable a enchufe manguera rápido.



GRIFOS DECORATIVOS

Grifos decorativos



128

GRIFOS DECORATIVOS



GRIFO FUENTE PÚBLICA CIERRE MONTURA



Código	Medida	Caja	Código Barras	€ / Ud.
1125	1/2"	1	8435195834086	45,85

• Modelo temporizado página 18

GRIFO JARDÍN DECORATIVO "RENACIMIENTO" S/COLOR



Código	Medida	Caja	Código Barras	€ / Ud.
24531	1/2"	10	8435195822403	38,68

GRIFO JARDÍN DECORATIVO "PATO" S/COLOR



Código	Medida	Caja	Código Barras	€ / Ud.
24532	1/2"	10	8435195822410	32,25

GRIFO JARDÍN DECORATIVO "PÁJARO" S/COLOR



Código	Medida	Caja	Código Barras	€ / Ud.
24533	1/2"	10	8435195822427	35,82

GRIFO JARDÍN DECORATIVO "RANA" S/COLOR



Código	Medida	Caja	Código Barras	€ / Ud.
24534	1/2"	10	8435195822434	35,82

GRIFO JARDÍN DECORATIVO "PEZ" S/COLOR



Código	Medida	Caja	Código Barras	€ / Ud.
24535	1/2"	10	8435195822441	32,25

GRIFO JARDÍN DECORATIVO "GALLO" S/COLOR



Código	Medida	Caja	Código Barras	€ / Ud.
24536	1/2"	10	8435195822458	26,44

GRIFOS DECORATIVOS



GRIFO CODILLO S/COLOR



	Código	Medida	Caja	Código Barras	€ / Ud.
Sin racor	24510	1/2"	10	8435195801682	6,92
	24512	3/4"	10	8435195801699	7,25



	Código	Medida	Caja	Código Barras	€ / Ud.
Con racor	24515	1/2"	10	8435195801729	9,94
	24516	3/4"	10	8435195801736	9,98
	24526	3/4" x 1"	10	8435195833966	14,70

GRIFO CODILLO CROMADO



	Código	Medida	Caja	Código Barras	€ / Ud.
Sin racor	24513	1/2"	10	8435195801705	6,91
	24514	3/4"	10	8435195801712	7,64



	Código	Medida	Caja	Código Barras	€ / Ud.
Con racor	24517	1/2"	10	8435195801743	9,43
	24518	3/4"	10	8435195801750	22,70

PLACA ATORNILLAR CROMADA



	Código	Medida	Caja	Código Barras	€ / Ud.
	25519	M-H 1/2"	10	8435195801989	5,32
	25521	H-H 1/2"	10	8435195802009	5,99

GRIFO DE LATÓN PARA BARRIL

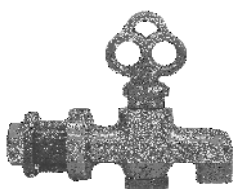

	Código	Descripción	Caja	Código Barras	€ / Ud.
	24520	Cón cánula	20	8435195820300	2,52
	24521	Sin cánula	20	8435195820317	2,28



REDUCTORES DE PRESIÓN Y MANÓMETROS

Reductores de presión



132

Manómetros



133

REDUCTORES DE PRESIÓN



REDUCTOR DE PRESIÓN CON RACORES H-H



Código	Medida	Caja	Código Barras	€ / Ud.
25601	1/2"	5	8435195802016	42,16
25602	3/4"	5	8435195802023	66,33
25603	1"	5	8435195802030	69,88
25604	1 1/4"	4	8435195802047	136,18
25605	1 1/2"	4	8435195802054	147,23
25606	2"	2	8435195802061	220,35
25607	2 1/2"	2	8435195802078	276,25
25608	3"	1	8435195824643	347,32

- Tipo de operación: pistón.
- Latón CW617N Niquelado.
- PN25.
- Regulación de 0,5 a 6 Bares.
- Pretarado a 3 bares.
- Temperatura máxima 80°C.
- Rosca H/H ISO 228
- Conexión para manómetroS 1/4".

REDUCTOR DE PRESIÓN SIN RACORES H-H



Código	Medida	Caja	Código Barras	€ / Ud.
25615	3/4"	5	8435195835786	52,80
25631	1"	5	8435195832808	57,75
25632	1 1/4"	2	8435195832815	114,73
25633	1 1/2"	2	8435195832822	125,13
25634	2"	2	8435195832839	198,25

- Tipo de operación: pistón.
- Latón CW617N
- PN25.
- Regulación de 0,5 a 6 Bares.
- Pretarado a 3 bares.
- Temperatura máxima 80°C.
- Rosca H/H ISO 228
- Conexión para manómetroS 1/4".

REDUCTOR DE PRESIÓN CON RACORES M-M

NUOVO
Prodotto



Código	Medida	Caja	Código Barras	€ / Ud.
25612	3/4"	1	8435195848052	55,64

- Tipo de operación: pistón.
- Latón CW617N Niquelado.
- PN25.
- Regulación de 0,5 a 6 Bares.
- Pretarado a 3 bares.
- Temperatura máxima 80°C.
- Rosca M/M ISO 228
- Conexión para manómetroS 1/4".

REDUCTOR DE PRESIÓN PARA CALENTADOR DE AGUA H-H



Código	Medida	Caja	Código Barras	€ / Ud.
25610	1/2"	5	8435195802085	19,67
25630	3/4"	5	8435195832792	20,46

- Tipo de operación: pistón.
- Latón CW617N-DW Niquelado.
- PN16.
- De 1 a 4 Bares.
- Pretarado a 3 bares.
- Temperatura máxima 80°C.
- Rosca H/H ISO 228.
- Conexión para manómetroS 1/4".

REDUCTORES DE PRESIÓN

Manómetros



DISPOSITIVO ANTI GOLPE DE ARIETE



Código	Medida	Caja	Código Barras	€ / Ud.
25611	1/2"	1	8435195824650	21,96

- PN10.
- Temperatura máxima 100°C.
- Fabricado en latón. Muelle de acero inox.
- Protege el reductor de presión.
- Mejora el funcionamiento y reduce el ruido.

MANÓMETRO SALIDA INFERIOR



Código	Medida	Caja	Código Barras	€ / Ud.
25702	1/4" 0 a 6 bares	1	8435195823233	6,27
25703	1/4" 0 a 10 bares	1	8435195823240	6,65
25704	1/4" 0 a 16 bares	1	8435195832846	6,40

- Caja ABS negra con esfera y aguja de aluminio. Interiores y racor en latón.
- Temperatura ambiente: -20 a +60°C. Fluido máximo: 60°C.
- Precisión CL. 1,6.

MANÓMETRO SALIDA POSTERIOR



Código	Medida	Caja	Código Barras	€ / Ud.
25712	1/4" 0 a 6 bares	1	8435195823257	6,61
25713	1/4" 0 a 10 bares	1	8435195823264	7,60

- Caja ABS negra con esfera y aguja de aluminio. Interiores y racor en latón.
- Temperatura ambiente: -20 a +60°C. Fluido máximo: 60°C.
- Precisión CL. 1,6.

MANÓMETRO SALIDA INFERIOR CON GLICERINA



Código	Medida	Caja	Código Barras	€ / Ud.
25725	1/4" x 63 0 a 6 bares	1	8435195832853	13,49
25726	1/4" x 63 0 a 10 bares	1	8435195832860	11,86
25730	1/4" x 63 0 a 40 bares	1	8435195835892	15,57
25729	1/4" x 63 0 a 60 bares	1	8435195835885	11,83
25727	1/4" x 100 0 a 10 bares	1	8435195832877	23,93
25728	1/4" x 100 0 a 40 bares	1	8435195835878	28,01

- Caja acero inox. con esfera ABS y aguja de aluminio. Interiores y racor en latón.
- Temperatura ambiente: -20 a +60°C. Fluido máximo: 60°C.
- Precisión CL. 1,6.

MANÓMETRO SALIDA POSTERIOR CON GLICERINA



Código	Medida	Caja	Código Barras	€ / Ud.
25742	1/4" x 63 0 a 6 bares	1	8435195832884	11,74
25743	1/4" x 63 0 a 10 bares	1	8435195832891	11,39

- Caja acero inox. con esfera ABS y aguja de aluminio. Interiores y racor en latón.
- Temperatura ambiente: -20 a +60°C. Fluido máximo: 60°C.
- Precisión CL. 1,6.



VÁLVULAS DE RETENCIÓN Y FILTROS

Válvulas de retención H-H		136
Filtros		137
Válvulas de retención M-M		137
Válvulas de retención clapeta		138
Filtro colador tipo "Y"		138
Válvulas de compuerta		138
Válvulas esfera 3 vías		139
Válvulas esfera con retención incorporada		139
Válvulas esfera contador y accesorios		140

VÁLVULAS DE RETENCIÓN Y FILTROS



VÁLVULA DE RETENCIÓN TIPO "YORK" H-H



Código	Medida	Caja	Código Barras	€ / Ud.
26003	1/2"	50	8435195802092	4,06
26004	3/4"	50	8435195802108	5,99
26005	1"	40	8435195802115	7,32
26006	1 1/4"	20	8435195802122	17,06
26007	1 1/2"	20	8435195802139	16,75
26008	2"	10	8435195802146	30,47
26009	2 1/2"	1	8435195802153	71,50
26010	3"	1	8435195802160	65,98
26011	4"	1	8435195802177	109,14

- PN12 (3/8" a 1") PN10 (1 1/4" a 2") PN8 (2 1/2" a 4").
- Fabricado en latón.
- Disco de Nylon y muelle en acero inoxidable.
- Temperatura máxima: 90°C.
- Cierre con goma NBR.

VÁLVULA DE RETENCIÓN CON FILTRO



Código	Medida	Caja	Código Barras	€ / Ud.
26016	1/2"	20	8435195824377	3,95
26017	3/4"	20	8435195824384	5,44
26018	1"	10	8435195824391	8,45
26019	1 1/4"	5	8435195824407	13,23
26020	1 1/2"	5	8435195824414	13,05
26021	2"	5	8435195824421	24,55
26022	2 1/2"	1	8435195824438	49,95
26023	3"	1	8435195824445	75,09
26024	4"	1	8435195824636	99,25

- PN16 (1/2" a 1") PN10 (1 1/4" a 2") PN8 (2 1/2" a 4").
- Fabricado en latón.
- Disco de Nylon.
- Muelle y filtro en acero inox.
- Temperatura máxima: 80°C.
- Cierre con goma NBR.

VÁLVULA RETENCIÓN CIERRE METÁLICO H-H



Código	Medida	Caja	Código Barras	€ / Ud.
26101	3/8"	10	8435195826715	4,99
26102	1/2"	50	8435195802191	4,72
26103	3/4"	40	8435195802207	6,58
26104	1"	40	8435195802214	9,75
26105	1 1/4"	20	8435195802221	15,12
26106	1 1/2"	20	8435195802238	19,30
26107	2"	10	8435195802245	28,64
26108	2 1/2"	1	8435195802252	57,20
26109	3"	1	8435195802269	87,78
26110	4"	1	8435195826722	155,42

- PN25 (3/8" a 1") PN16 (1 1/4" a 2") PN10 (2 1/2" a 4").
- Fabricado en latón.
- Disco y guía de latón.
- Temperatura máxima: 80°C.
- Cierre con goma NBR.

VÁLVULAS DE RETENCIÓN Y FILTROS



FILTRO ACERO INOXIDABLE



Código	Medida	Caja	Código Barras	€ / Ud.
26503	1/2"	50	8435195802276	0,99
26504	3/4"	50	8435195802283	1,18
26505	1"	20	8435195802290	1,49
26506	1 1/4"	10	8435195802306	1,98
26507	1 1/2"	10	8435195802313	2,40
26508	2"	10	8435195802320	3,40
26509	2 1/2"	2	8435195802337	7,95
26510	3"	2	8435195802344	8,75
26511	4"	2	8435195802351	10,99

- Racor de Nylon.
- Malla de acero inoxidable:
de 1/2" a 2" perforada a 1,2 mm.
de 2 1/2" a 4" perforada a 2 mm.
- Para agua, aire y fluidos no agresivos.
- Para válvulas de retención con rosca Hembra - Hembra.

FILTRO ABS



Código	Medida	Caja	Código Barras	€ / Ud.
26516	1/2"	50	8435195802368	0,70
26517	3/4"	50	8435195802375	0,76
26518	1"	20	8435195802382	0,93
26519	1 1/4"	10	8435195802399	1,51
26520	1 1/2"	10	8435195802405	1,64
26521	2"	10	8435195802412	2,47

- Para válvulas de retención con rosca Hembra - Hembra.

VÁLVULA RETENCIÓN M-M



Código	Medida	Caja	Código Barras	€ / Ud.
26202	1/2"	50	8435195822465	7,62
26203	3/4"	40	8435195822472	9,15
26204	1"	5	8435195826739	9,92

- PN16.
- Fabricado en latón.
- Disco de nylon.
- Roscas Macho - Macho.
- Temperatura máxima: 80°C.

VÁLVULAS DE RETENCIÓN Y FILTROS



VÁLVULA RETENCIÓN CLAPETA H-H



Código	Medida	Caja	Código Barras	€ / Ud.
26601	1/2"	50	8435195802429	5,40
26602	3/4"	50	8435195802436	8,32
26603	1"	20	8435195802443	16,20
26604	1 1/4"	10	8435195802450	23,15
26605	1 1/2"	10	8435195802467	28,97
26606	2"	10	8435195802474	48,36
26607	2 1/2"	2	8435195802481	99,66
26608	3"	2	8435195802498	145,35
26609	4"	2	8435195802504	245,58

- PN16 (1/2" a 1") PN10 (1 1/4" a 2") PN8 (2 1/2" a 4").
- Fabricado en latón.
- Clapeta de latón.
- Temperatura máxima: 90°C.
- Cierre con goma NBR.

FILTRO COLADOR TIPO "Y" H-H



Código	Medida	Caja	Código Barras	€ / Ud.
26613	1/2"	30	8435195802511	5,54
26614	3/4"	20	8435195802528	8,89
26615	1"	10	8435195802535	9,07
26616	1 1/4"	6	8435195802542	23,94
26617	1 1/2"	4	8435195802559	29,94
26618	2"	2	8435195802566	57,44
26619	2 1/2"	1	8435195820553	110,67
26620	3"	1	8435195820560	99,86
26621	4"	1	8435195820577	164,30

- PN16.
- Fabricado en latón.
- Filtro de acero inoxidable.
- Temperatura máxima: 100°C.

VÁLVULA COMPUERTA CON CIERRE DE GOMA H-H



Código	Medida	Caja	Código Barras	€ / Ud.
26622	1/2"	10	8435195822489	11,46
26623	3/4"	10	8435195822496	15,12
26624	1"	5	8435195822502	20,05
26625	1 1/4"	5	8435195822519	33,86
26626	1 1/2"	5	8435195822526	58,99
26627	2"	2	8435195822533	75,40
26628	2 1/2"	1	8435195822540	173,08
26629	3"	1	8435195822557	159,60
26630	4"	1	8435195822564	322,56

- PN16.
- Fabricado en latón.
- Cierre compuerta latón + NBR vulcanizado.
- Temperatura máxima: 80°C.
- Maneta roja de acero.

VÁLVULA COMPUERTA CON CIERRE DE LATÓN H-H



Código	Medida	Caja	Código Barras	€ / Ud.
26640	1/2"	10	8435195822571	5,24
26641	3/4"	10	8435195822588	8,73
26642	1"	5	8435195822595	13,93
26643	1 1/4"	5	8435195822601	14,18
26644	1 1/2"	5	8435195822618	19,88
26645	2"	2	8435195822625	30,66
26646	2 1/2"	1	8435195822632	80,14
26647	3"	1	8435195822649	95,71
26648	4"	1	8435195822656	287,37

- PN10.
- Fabricado en latón.
- Cierre disco de latón.
- Temperatura máxima: 110°C.
- Maneta roja de acero.

VÁLVULAS DE RETENCIÓN Y FILTROS



VÁLVULA ESFERA 3 VÍAS PASO "T"



Código	Medida	Caja	Código Barras	€ / Ud.
22552	1/2"	10	8435195835380	27,78
22553	3/4"	10	8435195835397	45,40
22554	1"	5	8435195835403	66,87
22555	1 1/4"	5	8435195835410	122,10
22556	1 1/2"	1	8435195835427	152,42
22557	2"	1	8435195835434	246,05

- PN16.
- Temperatura máxima: 130°C.
- Válvula con bola de latón.

VÁLVULA ESFERA 3 VÍAS PASO "L"



Código	Medida	Caja	Código Barras	€ / Ud.
22542	1/2"	10	8435195835311	39,20
22543	3/4"	10	8435195835328	59,84
22544	1"	5	8435195835335	66,87
22545	1 1/4"	5	8435195835342	99,23
22546	1 1/2"	1	8435195835359	184,69
22547	2"	1	8435195835366	246,05

- PN16.
- Temperatura máxima: 130°C.
- Válvula con bola de latón.

VÁLVULA ESFERA CON RETENCIÓN INCORPORADA



Código	Medida	Caja	Código Barras	€ / Ud.
26660	1/2"	10	8435195823271	8,96
26661	3/4"	10	8435195823288	17,79
26662	1"	5	8435195823295	24,45

- PN16.
- Latón EN 12165 niquelado.
- Temperatura máxima: 95°C.
- Prensa estopa con guarnición de PTFE.
- Cierre retención EPDM.
- Muelle en acero inoxidable.

VÁLVULAS DE RETENCIÓN Y FILTROS



VÁLVULA ESFERA ENTRADA CONTADOR ORIENTABLE



Código	Medida	Caja	Código Barras	€ / Ud.
26666	DN15 Racor 3/4"	10	8435195823301	18,98
26667	DN15 Racor 7/8"	10	8435195824698	21,72

- Cuerpo, esfera, conexiones y eje fabricado en latón.
- Brida orientable que permite su colocación en cualquier batería.
- Juntas tóricas NBR y juntas de teflón PTFE.

VÁLVULA ESFERA ENTRADA CONTADOR ORIENTABLE



Código	Medida	Caja	Código Barras	€ / Ud.
26676	DN15 Racor 3/4"	10	8435195826746	15,86

- Cuerpo, esfera, conexiones y eje fabricado en latón.
- Brida orientable que permite su colocación en cualquier batería.
- Juntas tóricas NBR y juntas de teflón PTFE.

VÁLVULA ESFERA SALIDA CONTADOR ANTIRRETORNO



Código	Medida	Caja	Código Barras	€ / Ud.
26675	DN15 Racor 3/4"	10	8435195823332	11,40

- Cuerpo, esfera, conexiones y eje fabricado en latón.
- Provista de dispositivo antirretorno en la salida.
- Juntas tóricas NBR y juntas de teflón PTFE.

MANGUITO CONTADOR



Código	Medida	Caja	Código Barras	€ / Ud.
26670	DN20 Racor 3/4"	10	8435195823318	2,24
26671	DN15 Racor 7/8"	10	8435195823325	3,55
26673	DN15 Racor 3/4"	10	8435195824704	2,96
26678	Racor 3/4" Izq.-7/8" Drch.	10	8435195836226	2,80

JUNTA CAUCHO BRIDA ORIENTABLE

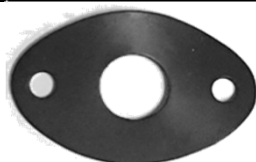

Código	Medida	Caja	Código Barras	€ / Ud.
99344	Única	10	8435195832907	1,19

CUERPO BRIDA NÍQUEL



Código	Medida	Caja	Código Barras	€ / Ud.
99083	3/4"	5	8435195823363	4,75

LATERAL BRIDA NÍQUEL



Código	Medida	Caja	Código Barras	€ / Ud.
99093	3/4"	5	8435195823400	2,29



RACORES DE CONTADOR Y ACCESORIOS

Racores de contador y accesorios		142
Racor telescópico		142
Purgador con tornillo		142
Hornacina para contador		142

RACORES DE CONTADOR Y ACCESORIOS



RACOR CONTADOR ROSCAR (Racor, tuerca y junta)



Código	Medida	Caja	Código Barras	€ / Ud.
99522	1/2" x 1/2"	25	8435195816617	6,60
98080	5/8" x 1/2"	25	8435195816624	6,99
89081A	3/4" x 1/2"	25	8435195816631	3,51
89083	7/8" x 1/2"	25	8435195816648	4,64
89085A	1" x 3/4"	10	8435195816655	5,47
89076	1 1/4" x 1"	5	8435195816662	9,79
89077	1 1/2" x 1 1/4"	5	8435195816679	12,81
89078	2" x 1 1/2"	2	8435195816686	19,14
98079	2 1/2" x 2"	2	8435195816693	21,99

RACOR CONTADOR SOLDAR (Racor, purgador, tuerca y junta)



Código	Medida	Caja	Código Barras	€ / Ud.
89080A	7/8" x 18/22	25	8435195816709	4,45
89083A	3/4" x 18	25	8435195816716	4,45

RACOR TELESCÓPICO

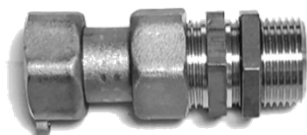

Código	Medida	Caja	Código Barras	€ / Ud.
98061	7/8" x 3/4" x 90 mm.	5	8435195824872	31,16
98101	3/4" x 3/4" x 66 mm.	5	8435195824711	18,48
98105	3/4" x 3/4" x 90 mm.	5	8435195826753	29,99

PURGADOR CON TORNILLO S/COLOR



Código	Medida	Caja	Código Barras	€ / Ud.
89090	1/8"	25	8435195816730	0,85

JUNTAS PARA RACOR CONTADOR

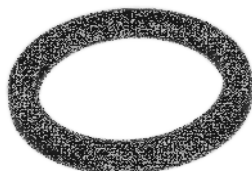

Código	Medida	Caja	Código Barras	€ / Ud.
83604	1/2" 14 x 18,5 x 2	100	8435195822663	0,035
89092	3/4" 17 x 23,5 x 2,5	100	8435195816754	0,080
89101	5/8" 21 x 14 x 2	100	8435195816785	0,080
89093	7/8" 21 x 27 x 2,5	100	8435195816761	0,090
84510	7/8" 22 x 27 x 2,5	100	8435195816778	0,098
89091	1" 22 x 30 x 2,5	100	8435195816747	0,120
83511	1 1/4" 29 x 38 x 2,5	25	8435195825145	0,180
83512	1 1/2" 35 x 45 x 3	25	8435195825152	0,390
83513	2" 44 x 55 x 3	25	8435195825169	0,420
83510	2 1/2" 50 x 69 x 4	10	8435195823424	0,510

HORNACINA PARA CONTADOR DE AGUA ACERO INOX.



Código	Medida	Caja	Código Barras	€ / Ud.
90091	400 x 300 x 110	1	8435195816792	165,65

- Tiene 2 entradas.



ACCESORIOS PARA TUBO DE POLIETILENO

Anillo de nylon	DESCATALOGADO		144
Anillo de latón			146
Anillo de acero inox. con bridas			148
Recambios			150

ACCESORIOS TUBO POLIETILENO

Anillo de nylon



RACOR RECTO HEMBRA A TUBO anillo de nylon

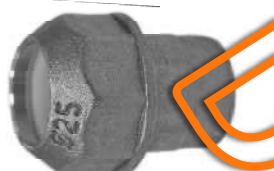

Código	Medida	Caja	Código Barras	€ / Ud.
30003	1/2" x 20 Ø	25		
30004	3/4" x 25 Ø	15		
30005	1" x 32 Ø	10		
30006	1 1/4" x 40 Ø	5		
30007	1 1/2" x 50 Ø	6		
30008	2" x 63 Ø	4		

RACOR RECTO MACHO A TUBO anillo de nylon



Código	Medida	Caja	Código Barras	€ / Ud.
31503	1/2" x 20 Ø	40		
31504	3/4" x 25 Ø	20		
31505	1" x 32 Ø	15		
31506	1 1/4" x 40 Ø	8		
31507	1 1/2" x 50 Ø	10		
31508	2" x 63 Ø	6		

RACOR RECTO UNIÓN TUBO A TUBO anillo de nylon

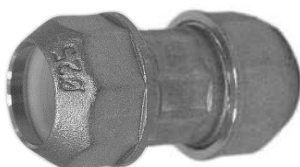

Código	Medida	Caja	Código Barras	€ / Ud.
33003	20 x 20 Ø	25		
33004	25 x 25 Ø	15		
33005	32 x 32 Ø	10		
33007	50 x 50 Ø	6		
33008	63 x 63 Ø	4		

RACOR CODO HEMBRA A TUBO anillo de nylon



Código	Medida	Caja	Código Barras	€ / Ud.
37503	1/2" x 20 Ø	30		
37504	3/4" x 25 Ø	18		
37506	1 1/4" x 40 Ø	5		
37507	1 1/2" x 50 Ø	6		
37508	2" x 63 Ø	4		

RACOR CODO MACHO A TUBO anillo de nylon



Código	Medida	Caja	Código Barras	€ / Ud.
36003	1/2" x 20 Ø	30		
36004	3/4" x 25 Ø	18		
36005	1" x 32 Ø	10		
36006	1 1/4" x 40 Ø	5		
36007	1 1/2" x 50 Ø	6		
36008	2" x 63 Ø	4		

ACCESORIOS TUBO POLIETILENO

Anillo de nylon



RACOR CODO UNIÓN TUBO A TUBO anillo de nylon

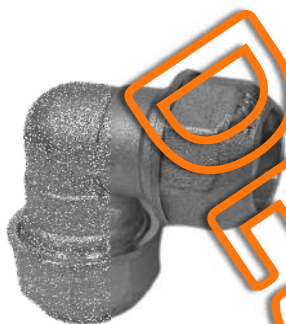

Código	Medida	Caja	Código Barras	€ / Ud.
34503	20 x 20 Ø	20		
34504	25 x 25 Ø	10		
34505	32 x 32 Ø	8		
34506	40 x 40 Ø	3		
34508	63 x 63 Ø	3		

RACOR CODO PLACA HEMBRA A TUBO anillo de nylon



Código	Medida	Caja	Código Barras	€ / Ud.
37525	1/2" x 20 Ø	20		
37526	3/4" x 25 Ø	8		

RACOR TE HEMBRA A TUBO anillo de nylon



Código	Medida	Caja	Código Barras	€ / Ud.
38003	1/2" x 20 Ø	18		
38004	3/4" x 25 Ø	10		
38006	1 1/4" x 40 Ø	4		
38007	1 1/2" x 50 Ø	4		
38008	2" x 63 Ø	2		

RACOR TE UNIÓN TUBO A TUBO anillo de nylon



Código	Medida	Caja	Código Barras	€ / Ud.
39003	20 x 20 x 20 Ø			
39004	25 x 25 x 25 Ø			
39005	32 x 32 x 32 Ø			
39006	40 x 40 x 40 Ø			
39007	50 x 50 x 50 Ø			
39008	63 x 63 x 63 Ø			

ACCESORIOS TUBO POLIETILENO

Anillo de latón



RACOR RECTO HEMBRA A TUBO anillo de latón



Código	Medida	Caja	Código Barras	€ / Ud.
30013	1/2" x 20 Ø	40	8435195802771	3,41
30014	3/4" x 25 Ø	20	8435195802788	5,14
30015	1" x 32 Ø	15	8435195802795	6,71
30016	1 1/4" x 40 Ø	8	8435195802801	11,16
30017	1 1/2" x 50 Ø	10	8435195802818	22,28
30018	2" x 63 Ø	6	8435195802825	34,77

RACOR RECTO MACHO A TUBO anillo de latón



Código	Medida	Caja	Código Barras	€ / Ud.
31513	1/2" x 20 Ø	40	8435195802924	2,99
31514	3/4" x 25 Ø	20	8435195802931	4,09
31515	1" x 32 Ø	15	8435195802948	8,46
31516	1 1/4" x 40 Ø	8	8435195802955	13,66
31517	1 1/2" x 50 Ø	10	8435195802962	15,64
31518	2" x 63 Ø	6	8435195802979	23,21

RACOR RECTO UNIÓN TUBO A TUBO anillo de latón

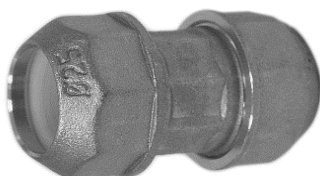

Código	Medida	Caja	Código Barras	€ / Ud.
33013	20 x 20 Ø	25	8435195803075	4,81
33014	25 x 25 Ø	15	8435195803082	6,98
33015	32 x 32 Ø	10	8435195803099	13,69
33016	40 x 40 Ø	5	8435195803105	19,33
33017	50 x 50 Ø	6	8435195803112	24,23
33018	63 x 63 Ø	4	8435195803129	37,72

RACOR CODO HEMBRA A TUBO anillo de latón



Código	Medida	Caja	Código Barras	€ / Ud.
37513	1/2" x 20 Ø	30	8435195803501	4,99
37514	3/4" x 25 Ø	18	8435195803518	6,88
37515	1" x 32 Ø	10	8435195803525	9,30
37516	1 1/4" x 40 Ø	5	8435195803532	16,42
37517	1 1/2" x 50 Ø	6	8435195803549	24,24
37518	2" x 63 Ø	4	8435195803556	41,80

RACOR CODO MACHO A TUBO anillo de latón



Código	Medida	Caja	Código Barras	€ / Ud.
36013	1/2" x 20 Ø	30	8435195803358	3,66
36014	3/4" x 25 Ø	18	8435195803365	7,18
36015	1" x 32 Ø	10	8435195803372	10,59
36016	1 1/4" x 40 Ø	5	8435195803389	14,99
36017	1 1/2" x 50 Ø	6	8435195803396	23,92
36018	2" x 63 Ø	4	8435195803402	45,32

ACCESORIOS TUBO POLIETILENO

Anillo de latón



RACOR CODO UNIÓN TUBO A TUBO anillo de latón



Código	Medida	Caja	Código Barras	€ / Ud.
34513	20 x 20 Ø	20	8435195803211	5,77
34514	25 x 25 Ø	10	8435195803228	8,04
34515	32 x 32 Ø	8	8435195803235	12,93
34516	40 x 40 Ø	3	8435195803242	26,65
34517	50 x 50 Ø	5	8435195803259	33,77
34518	63 x 63 Ø	3	8435195803266	51,99

RACOR CODO PLACA HEMBRA A TUBO anillo de latón



Código	Medida	Caja	Código Barras	€ / Ud.
37519	1/2" x 20 Ø	20	8435195803563	6,09
37520	3/4" x 25 Ø	12	8435195803570	9,79
37521	1" x 32 Ø	8	8435195803587	15,92

Código	Medida	Caja	Código Barras	€ / Ud.
37525	1/2" x 20 Ø Anillo nylon	#iREF!	#iREF!	#iREF!
37526	3/4" x 25 Ø Anillo nylon	8	8435195826777	7,83

RACOR TE HEMBRA A TUBO anillo de latón



Código	Medida	Caja	Código Barras	€ / Ud.
38013	1/2" x 20 Ø	18	8435195837469	5,99
38014	3/4" x 25 Ø	10	8435195803693	8,76
38015	1" x 32 Ø	6	8435195803709	15,25
38016	1 1/4" x 40 Ø	4	8435195803716	31,35
38017	1 1/2" x 50 Ø	4	8435195803723	34,55
38018	2" x 63 Ø	2	8435195803730	58,77

RACOR TE UNIÓN TUBO A TUBO anillo de latón



Código	Medida	Caja	Código Barras	€ / Ud.
39013	20 x 20 x 20 Ø	12	8435195803884	7,79
39014	25 x 25 x 25 Ø	8	8435195803891	13,20
39015	32 x 32 x 32 Ø	4	8435195803907	17,45
39016	40 x 40 x 40 Ø	3	8435195803914	27,81
39017	50 x 50 x 50 Ø	3	8435195803921	43,99
39018	63 x 63 x 63 Ø	2	8435195803938	66,79

ACCESORIOS TUBO POLIETILENO

Anillo de acero inoxidable con bridas



RACOR RECTO HEMBRA A TUBO anillo de acero inox. con bridas



Código	Medida	Caja	Código Barras	€ / Ud.
30009	2 1/2" x 75 Ø	4	8435195802740	90,44
30010	3" x 90 Ø	2	8435195802757	134,19
30011	4" x 110 Ø	2	8435195802764	217,73

RACOR RECTO MACHO A TUBO anillo de acero inox. con bridas



Código	Medida	Caja	Código Barras	€ / Ud.
31509	2 1/2" x 75 Ø	4	8435195802894	88,96
31510	3" x 90 Ø	2	8435195802900	143,50
31511	4" x 110 Ø	2	8435195802917	199,60

RACOR RECTO UNIÓN TUBO A TUBO anillo de acero inox. con bridas



Código	Medida	Caja	Código Barras	€ / Ud.
33009	75 x 75 Ø	4	8435195803044	122,44
33010	90 x 90 Ø	2	8435195803051	177,60
33011	110 x 110 Ø	1	8435195803068	399,50

RACOR CODO HEMBRA A TUBO anillo de acero inox. con bridas

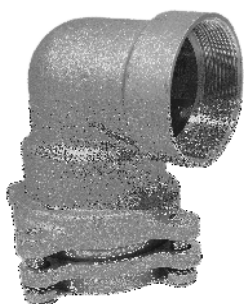

Código	Medida	Caja	Código Barras	€ / Ud.
37509	2 1/2" x 75 Ø	2	8435195803471	136,70
37510	3" x 90 Ø	2	8435195803488	181,82
37511	4" x 110 Ø	2	8435195803495	336,60

RACOR CODO MACHO A TUBO anillo de acero inox. con bridas



Código	Medida	Caja	Código Barras	€ / Ud.
36009	2 1/2" x 75 Ø	2	8435195803334	107,74
36010	3" x 90 Ø	2	8435195803341	160,24

ACCESORIOS TUBO POLIETILENO

Anillo de acero inoxidable con bridas



RACOR CODO UNIÓN TUBO A TUBO anillo de acero inox. con bridas

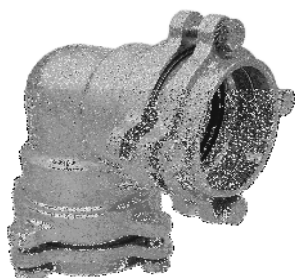

Código	Medida	Caja	Código Barras	€ / Ud.
34509	75 x 75 Ø	2	8435195803198	151,64
34510	90 x 90 Ø	2	8435195803204	221,98

RACOR TE HEMBRA A TUBO anillo de acero inox. con bridas

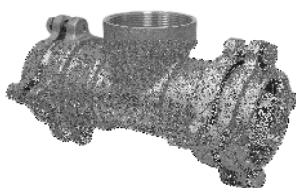

Código	Medida	Caja	Código Barras	€ / Ud.
38009	2 1/2" x 75 Ø	1	8435195803662	218,62
38010	3" x 90 Ø	1	8435195803679	254,47
38011	4" x 110 Ø	1	8435195803686	526,67

RACOR TE UNIÓN TUBO A TUBO anillo de acero inox. con bridas



Código	Medida	Caja	Código Barras	€ / Ud.
39009	75 x 75 x 75 Ø	1	8435195803860	217,70
39010	90 x 90 x 90 Ø	1	8435195803877	318,47

ACCESORIOS TUBO POLIETILENO

Recambios



ANILLO ABIERTO NYLON



Código	Medida	Caja	Código Barras	€ / Ud.
39025	20 Ø	10	8435195820645	0,14
39026	25 Ø	10	8435195820652	0,18
39027	32 Ø	10	8435195820669	0,21
39028	40 Ø	10	8435195820676	0,32
39029	50 Ø	10	8435195820683	0,39
39030	63 Ø	10	8435195820690	0,61

ARANDELA NYLON



Código	Medida	Caja	Código Barras	€ / Ud.
39060	20 Ø	10	8435195826845	0,12
39061	25 Ø	10	8435195826852	0,16
39062	32 Ø	10	8435195826869	0,17
39063	40 Ø	10	8435195826876	0,28
39064	50 Ø	10	8435195826883	0,32
39065	63 Ø	10	8435195826890	0,60

ANILLO ABIERTO LATÓN



Código	Medida	Caja	Código Barras	€ / Ud.
39019	20 Ø	10	8435195820584	0,77
39020	25 Ø	10	8435195820591	0,87
39021	32 Ø	10	8435195820607	1,35
39022	40 Ø	10	8435195820614	1,77
39023	50 Ø	10	8435195820621	3,25
39024	63 Ø	10	8435195820638	4,59

ARANDELA LATÓN

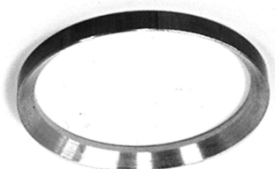

Código	Medida	Caja	Código Barras	€ / Ud.
39050	20 Ø	10	8435195826784	0,48
39051	25 Ø	10	8435195826791	0,58
39052	32 Ø	10	8435195826807	0,67
39053	40 Ø	10	8435195826814	1,26
39054	50 Ø	10	8435195826821	1,75
39055	63 Ø	10	8435195826838	3,08

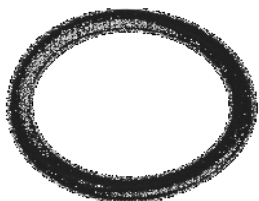

JUNTA TÓRICA



Código	Medida	Caja	Código Barras	€ / Ud.
39031	20 Ø	10	8435195820706	0,10
39032	25 Ø	10	8435195820713	0,15
39033	32 Ø	10	8435195820720	0,15
39034	40 Ø	10	8435195820737	0,36
39035	50 Ø	10	8435195820744	0,56
39036	63 Ø	10	8435195820751	0,80



GRIFOS FLOTADORES Y BOYAS

Flotadores		152
Boyas		152
Accesorios		156

GRIFOS FLOTADORES Y BOYAS



GRIFO FLOTADOR CAZOLETA



Código	Medida	Caja	Código Barras	€ / Ud.
57501	3/8"	100	8435195808025	4,35
57502	1/2"	50	8435195808032	8,89

	Código	Descripción	Código Barras	€ / Ud.
Recambio	58517	Varilla 220 mm. Rosca 3/16	8435195820348	0,80

GRIFO FLOTADOR GUÍA VARILLA REDONDA



Código	Medida	Caja	Código Barras	€ / Ud.
58002	3/8" 3/16 inox.	25	8435195832990	6,25
58003	1/2" 6/100	25	8435195808049	8,50
58004	3/4" 6/100	25	8435195808056	12,90
58005	1" 8/100	25	8435195808063	18,98
58006	1 1/4" 9/100	10	8435195808070	44,52
58007	1 1/2" 9/100	10	8435195808087	51,94
58008	2" 9/100	5	8435195808094	79,99

GRIFO FLOTADOR ACERO INOX. CIERRE SILICONA

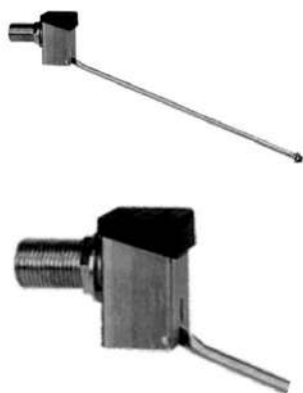

Código	Medida	Caja	Código Barras	€ / Ud.
58040	3/8" 6/100	1	8435195840865	24,92
58041	1/2" 6/100	1	8435195833003	24,05
58042	3/4" 8/100	1	8435195833010	45,18
58043	1" 8/100	1	8435195833027	49,73
58044	1 1/4" 8/100	1	8435195833034	54,78

- Fabricado en acero inoxidable AISI 304.
- Conexión rosca gas.
- Presión máxima de trabajo 10 Kg/cm.
- Cierre de silicona.
- Paso total.

GRIFO FLOTADOR GUÍA VARILLA ARTICULADA



Código	Medida	Caja	Código Barras	€ / Ud.
58016	1/2" 6/100	25	8435195808131	9,93
58017	3/4" 6/100	25	8435195808148	14,45
58018	1" 8/100	25	8435195808155	19,65

GRIFO FLOTADOR GUÍA VARILLA DESLIZANTE



Código	Medida	Caja	Código Barras	€ / Ud.
58019	1/2"	25	8435195808162	9,95
58020	3/4"	25	8435195808179	14,28
58021	1"	25	8435195808186	19,92
58022	1 1/4"	10	8435195808193	50,25
58023	1 1/2"	10	8435195808209	59,74
58024	2"	5	8435195808216	101,86
58025	2 1/2"	1	8435195820355	285,86
58026	3"	1	8435195820362	294,90

GRIFOS FLOTADORES Y BOYAS



GRIFO FLOTADOR SILENCIOSO MACHO



Código	Medida	Caja	Código Barras	€ / Ud.
57001	M 3/8" Tanque alto	100	8435195807943	4,25
57002	M 3/8" Tanque bajo	50	8435195807950	3,58

- Fabricado en latón niquelado.

GRIFO FLOTADOR SILENCIOSO HEMBRA



Código	Medida	Caja	Código Barras	€ / Ud.
57003	H 3/8" Tanque alto	50	8435195807967	3,90

- Fabricado en latón niquelado.

GRIFO FLOTADOR TELESCÓPICO VERTICAL CON BOYA



Código	Medida	Caja	Código Barras	€ / Ud.
57011	M 3/8" Tanque bajo	10	8435195807998	8,50

- Altura regulable.
- Con boya de plástico.

GRIFO FLOTADOR TELESCÓPICO LATERAL CON BOYA



Código	Medida	Caja	Código Barras	€ / Ud.
57007	M 3/8" Tanque bajo	10	8435195807981	5,10

- Altura regulable.
- Con boya de plástico.

GRIFO FLOTADOR VERTICAL



Código	Medida	Caja	Código Barras	€ / Ud.
57013	M 3/8"	10	8435195808001	14,13

- Altura regulable.
- Con boya integrada.

GRIFO FLOTADOR LATERAL



Código	Medida	Caja	Código Barras	€ / Ud.
57014	M 3/8"	10	8435195808018	11,05

- Altura regulable.
- Con boya integrada.

GRIFO FLOTADOR COMPACTO DUO

NUEVO
Producto



Código	Medida	Caja	Código Barras	€ / Ud.
57015	M 3/8"	10	8435195848076	14,50

- Flotador para cisterna con toma baja o toma lateral.
- Altura regulable.
- Con boya integrada.

GRIFOS FLOTADORES Y BOYAS



BOYA DE POREXPAN CILÍNDRICA CON SOPORTE GUÍA



Código	Medida			Caja	Código Barras	€ / Ud.
58500	3/8"	3/16	70 x 80 Ø	40	8435195808223	0,99

- Para grifo flotador cazoleta.
- Para grifo flotador silencioso.

BOYA DE POREXPAN ESFÉRICA



Código	Medida			Caja	Código Barras	€ / Ud.
58501	3/8"	3/16	90 Ø	200	8435195808230	0,88
58502	1/2"	3/16	110 Ø	80	8435195808247	1,52
58516	1/2"	6/100	110 Ø	80	8435195808254	1,54
58519	3/4"	6/100	130 Ø	10	8435195826906	2,48

- Para grifo flotador cazoleta.
- Para grifo flotador silencioso.

BOYA DE PLÁSTICO ESFÉRICA



Código	Medida			Caja	Código Barras	€ / Ud.
58508	3/8"	3/16	90 Ø	220	8435195808261	0,99
58534	3/8"	6/100	90 Ø	220	8435195840964	0,92
58537	1/2"	3/16	110 Ø	120	8435195840988	2,09
58503	1/2"	6/100	110 Ø	120	8435195808278	2,51
58504	3/4"	6/100	130 Ø	66	8435195808285	2,62
58538	3/4"	7/100	130 Ø	66	8435195840995	2,57
58539	1"	6/100	150 Ø	26	8435195841008	3,60
58505	1"	8/100	150 Ø	26	8435195808292	3,80
58506	1 1/4"	9/100	200 Ø	18	8435195808308	5,19
58507	2"	9/100	230 Ø	12	8435195808315	7,19

- Para grifo flotador guía varilla redonda.

BOYA DE PLÁSTICO PLANA

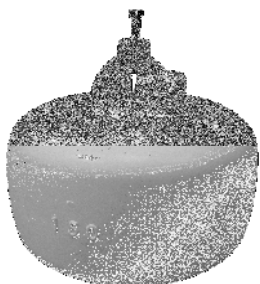

Código	Medida		Caja	Código Barras	€ / Ud.
58530	1/2" y 3/4"	120 Ø	66	8435195821314	5,95
58531	1"	150 Ø	26	8435195821321	6,34
58532	1 1/4", 1 1/2" y 2"	200 Ø	18	8435195821338	9,36
58533	2 1/2" y 3"	250 Ø	12	8435195821345	12,78

- Para grifo flotador guía varilla redonda y deslizante.

GRIFOS FLOTADORES Y BOYAS



BOYA DE COBRE PLANA



Código	Medida	Caja	Código Barras	€ / Ud.
58509	1/2" 120 Ø	25	8435195808339	23,27
58510	3/4" 150 Ø	25	8435195808346	28,76
58511	1" 170 Ø	25	8435195808353	32,89
58512	1 1/4" 200 Ø	10	8435195808360	76,90
58513	1 1/2" 230 Ø	10	8435195808377	55,69
58514	2" 250 Ø	5	8435195808384	87,95
58515	2 1/2" 280 Ø	2	8435195820287	123,05
58518	3" 300 Ø	2	8435195820294	142,63

- Para grifo flotador guía varilla redonda y deslizante.

BOYA DE LATÓN ESFÉRICA



Código	Medida	Caja	Código Barras	€ / Ud.
58526	3/8" 90 Ø	10	8435195826913	14,67
58520	1/2" 110 Ø	25	8435195808391	18,98
58521	3/4" 130 Ø	25	8435195808407	21,70
58522	1" 150 Ø	25	8435195808414	26,98
58523	1 1/4" 180 Ø	10	8435195808421	57,50
58524	1 1/2" 200 Ø	10	8435195808438	66,46
58525	2" 230 Ø	5	8435195808445	56,63

- Para grifo flotador guía varilla redonda.

BOYA DE ACERO INOXIDABLE ESFÉRICA



Código	Medida	Caja	Código Barras	€ / Ud.
58546	3/8" 90 Ø	1	8435195841053	21,30
58544	1/2" 110 Ø	1	8435195833041	22,96
58545	3/4" 160 Ø	1	8435195833058	54,94

- Para grifo flotador guía varilla redonda.

GRIFOS FLOTADORES Y BOYAS

Accesorios



JUNTA MEMBRANA FLOTADOR



Código	Medida	Caja	Código Barras	€ / Ud.
57016	3/8" x 18,50	25	8435195833065	0,25
57017	3/8" x 24	25	8435195833850	0,29

TUERCA ABS CON HEXÁGONO



Código	Medida	Caja	Código Barras	€ / Ud.
57020	3/8"	25	8435195833072	0,20
57021	1/2"	25	8435195833843	0,24

• ABS blanco.

JUNTA CIERRE TAZA TANQUE ESPECIAL



Código	Medida	Caja	Código Barras	€ / Ud.
72051	110 x 72 mm.	25	8435195833089	1,28

• Goma material espumoso

JUNTA CIERRE TAZA TANQUE CISTERNA BAJA



Código	Medida	Caja	Código Barras	€ / Ud.
72050	97 x 57 mm.	25	8435195826920	1,41

• Caucho



CISTERNA E INODORO

Descargadores y gomas		158
Cisterna y accesorios		161
Tiradores		162
Gomas y juntas		163
Manguitos y tapones		164
Tapas inodoro		166
Accesorios de baño		167

CISTERNA E INODORO



DESCARGADOR CISTERNA TANQUE ALTO



Código	Descripción	Caja	Código Barras	€ / Ud.
72001	PVC	10	8435195811711	3,56

CAMPANA DESCARGADOR CISTERNA TANQUE ALTO



Código	Descripción	Caja	Código Barras	€ / Ud.
72002	PVC	10	8435195811728	3,28

REBOSADERO CON TOPE DESCARGADOR TANQUE ALTO



Código	Descripción	Caja	Código Barras	€ / Ud.
72003	PVC	10	8435195811735	0,40

GOMA OBTURADORA DESCARGADOR TANQUE ALTO



Código	Medida	Caja	Código Barras	€ / Ud.
72004	5 x 45 mm.	5	8435195811742	0,50

GOMA OBTURADORA DESCARGADOR TANQUE ALTO



Código	Medida	Caja	Código Barras	€ / Ud.
72046	7 x 45 mm.	10	8435195842333	0,55

GANCHILLO DESCARGADOR TANQUE ALTO



Código	Descripción	Caja	Código Barras	€ / Ud.
72005	Acero Inox.	10	8435195811759	0,35

GOMA CÓNICA BAJANTE CISTERNA TANQUE ALTO



Código	Medida	Caja	Código Barras	€ / Ud.
72012	1 1/4" x 32 mm.	10	8435195811766	0,35

CISTERNA E INODORO



DESCARGADOR CISTERNA TANQUE BAJO REGULABLE



Código	Descripción	Caja	Código Barras	€ / Ud.
72006	PVC	10	8435195811773	4,29

- Rosca universal tipo Roca.

CAMPANA DESCARGADOR CISTERNA TANQUE BAJO REGULABLE



Código	Descripción	Caja	Código Barras	€ / Ud.
72007	PVC	10	8435195811780	3,63

GOMA OBTURADORA DESCARGADOR TANQUE BAJO

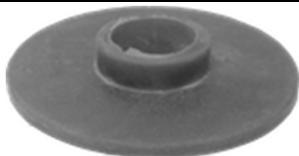

Código	Medida	Caja	Código Barras	€ / Ud.
72008	17 x 60 mm.	100	8435195811797	0,69

GOMA OBTURADORA DESCARGADOR TANQUE BAJO



Código	Medida	Caja	Código Barras	€ / Ud.
72009	23 x 73	100	8435195811803	0,90

- Tipo Roca.

GOMA ASIENTO ROCA SILICONA TANQUE BAJO

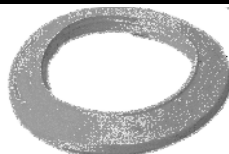

Código	Medida	Caja	Código Barras	€ / Ud.
72010	75 x 50 mm.	100	8435195811810	0,62

BASE CON TUERCA DESCARGADOR CISTERNA TANQUE BAJO

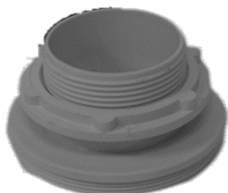

Código	Descripción	Caja	Código Barras	€ / Ud.
72011	PVC	10	8435195811827	2,49

JUNTA CIERRE TAZA TANQUE CISTERNA BAJA



Código	Medida	Caja	Código Barras	€ / Ud.
72050	97 x 57 mm.	25	8435195826920	1,41

JUNTA CIERRE TAZA TANQUE CISTERNA BAJA ESPECIAL



Código	Medida	Caja	Código Barras	€ / Ud.
72051	110 x 72 mm.	25	8435195833089	1,28

CISTERNA E INODORO



DESCARGADOR CISTERNA DE PULSADOR SIMPLE



Código	Descripción	Caja	Código Barras	€ / Ud.
72039	PVC	1	8435195833096	15,96

- Compatible con el sistema Roca. (Tradicional de rosca)
- Fabricados con materiales plásticos de alta calidad y anticalcáreos.

DESCARGADOR CISTERNA DE PULSADOR ININTERRUMPLIBLE



Código	Descripción	Caja	Código Barras	€ / Ud.
72044	PVC	1	8435195833126	17,57

- Compatible con el sistema Roca. (Tradicional de rosca)
- Fabricados con materiales plásticos de alta calidad y anticalcáreos.

	Código	Descripción	Código Barras	€ / Ud.
Recambio	72045	Goma obturadora	8435195842326	1,34
	72052	Pulsador	8435195842371	3,94

DESCARGADOR CISTERNA DE DOBLE PULSADOR ORIENTABLE



Código	Descripción	Caja	Código Barras	€ / Ud.
72042	PVC	1	8435195833119	17,57

- Compatible con el sistema Roca. (Tradicional de rosca)
- Fabricados con materiales plásticos de alta calidad y anticalcáreos.
- Pulsador de accionamiento remoto (cable de acero) que puede ser ubicado en cualquier lado del tanque.
- Doble descarga, ambas regulables. (Descarga media y descarga total).
- Pulsador preparado para agujeros de cualquier dimensión.

	Código	Descripción	Código Barras	€ / Ud.
Recambio	72047	Goma obturadora	8435195842340	1,28
	72049	Pulsador	8435195842364	4,48

DESCARGADOR CISTERNA DE DOBLE PULSADOR UNIVERSAL



Código	Descripción	Caja	Código Barras	€ / Ud.
72041	PVC	1	8435195833102	17,57

- Compatible con el sistema Roca. (Tradicional de rosca)
- Fabricados con materiales plásticos de alta calidad y anticalcáreos.
- Doble descarga, ambas regulables. (Descarga media y descarga total).

	Código	Descripción	Código Barras	€ / Ud.
Recambio	72047	Goma obturadora	8435195842340	1,28
	72048	Pulsador	8435195842357	4,82

DESCARGADOR CISTERNA DE DOBLE PULSADOR UNIVERSAL



Código	Descripción	Caja	Código Barras	€ / Ud.
72043	PVC	1	8435195842319	7,98

- Fabricados con materiales plásticos de alta calidad y anticalcáreos.
- Regulable en altura.
- Doble descarga, ambas regulables. (Descarga media y descarga total).

CISTERNA E INODORO



CASCO CISTERNA TANQUE ALTO



Código	Descripción	Caja	Código Barras	€ / Ud.
72015	ABS blanco	24	8435195811889	5,44

BAJANTE CISTERNA TANQUE ALTO



Código	Descripción	Caja	Código Barras	€ / Ud.
72020	ABS blanco	10	8435195801972	7,54

CONJUNTO ACCESORIOS CISTERNA TANQUE ALTO

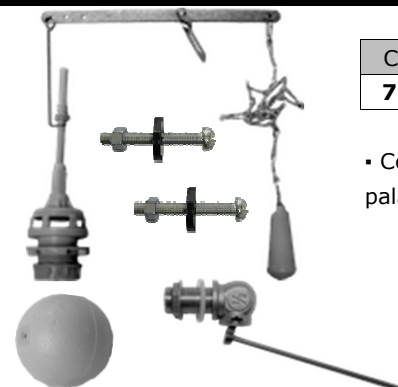

Código	Descripción	Caja	Código Barras	€ / Ud.
72016	Conjunto completo	10	8435195811896	10,25

- Contiene: descargador tanque alto, grifo flotador cazoleta 3/8, boya de espuma, palanca descargador, tirador tanque alto con pomo y juego tornillos palanca.

PALANCA DESCARGADOR CISTERNA ALTA



Código	Descripción	Caja	Código Barras	€ / Ud.
72013	ABS	100	8435195811858	0,56



Código	Descripción	Caja	Código Barras	€ / Ud.
72014	Acero	200	8435195811865	2,04



Código	Descripción	Caja	Código Barras	€ / Ud.
72017	Acero con soporte de latón	150	8435195811872	3,93

JUEGO DOS TORNILLOS SOPORTE PALANCA



Código	Medida	Caja	Código Barras	€ / Ud.
72018	M5 x 35 mm.	100	8435195811902	0,43

CISTERNA E INODORO



TIRADOR CISTERNA TANQUE ALTO CLÁSICO



Código	Descripción	Caja	Código Barras	€ / Ud.
72022	ABS blanco	25	8435195811926	1,56

TIRADOR CISTERNA TANQUE ALTO PLANO



Código	Descripción	Caja	Código Barras	€ / Ud.
72021	ABS blanco	25	8435195811919	0,98

TIRADOR CISTERNA TANQUE ALTO BOMBILLA



Código	Descripción	Caja	Código Barras	€ / Ud.
72023	Cristal	25	8435195811933	1,85

TIRADOR CISTERNA TANQUE ALTO ANILLA



Código	Descripción	Caja	Código Barras	€ / Ud.
72038	ABS Blanco	25	8435195847673	1,98

TIRADOR CISTERNA TANQUE BAJO ABS



Código	Descripción	Caja	Código Barras	€ / Ud.
72025	Recto	25	8435195811964	2,40
72027	Curvo	25	8435195811988	2,40

TIRADOR CISTERNA TANQUE BAJO METAL



Código	Descripción	Caja	Código Barras	€ / Ud.
72026	Recto	25	8435195811971	3,23
72028	Curvo	25	8435195811995	3,41

CISTERNA E INODORO



GOMA OBTURADORA TIPO ROCA ANTIGUA

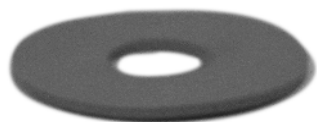

Código	Medida	Caja	Código Barras	€ / Ud.
72030	70 x 23 x 3 mm.	50	8435195812008	0,43

GOMA OBTURADORA TIPO ROCA NUEVA



Código	Medida	Caja	Código Barras	€ / Ud.
72031	68 x 33 x 3 mm.	50	8435195812015	0,39

DISCO FLOTADOR TIPO ROCA

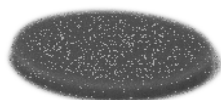

Código	Medida	Caja	Código Barras	€ / Ud.
72032	29 x 3 mm.	50	8435195812022	0,17

JUNTA SEMI PLANA FREGADERO



Código	Medida	Caja	Código Barras	€ / Ud.
72033	68 X 40 5,5 mm.	50	8435195812039	0,58

JUNTA SEMI PLANA BAÑERA



Código	Medida	Caja	Código Barras	€ / Ud.
72034	79 x 45 x 6,5 mm.	50	8435195812046	1,18

CISTERNA E INODORO

Manguitos WC



MANGUITO FLEXIBLE LABIADO INODORO



	Código	Medida	Caja	Código Barras	€ / Ud.
Recto	25543	110 Ø	10	8435195828245	3,50



	Código	Medida	Caja	Código Barras	€ / Ud.
Excéntrico	25544	110 Ø	10	8435195828252	3,50

MANGUITO INODORO COMPRIMIBLE



	Código	Medida	Caja	Código Barras	€ / Ud.
	63516	90 / 100 / 110 Ø x 400 mm.	18	8435195823660	10,30

MANGUITO INODORO EXTENSIBLE

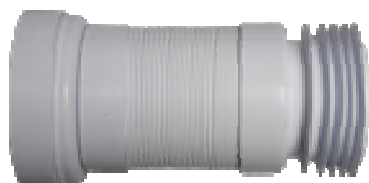

	Código	Medida	Caja	Código Barras	€ / Ud.
	63505	90 / 100 / 110 Ø x 250-530 mm	25	8435195821369	6,35

MANGUITO PVC PARA INODORO



	Código	Medida	Caja	Código Barras	€ / Ud.
Recto	25546	90 Ø	36	8435195820546	4,32



	Código	Medida	Caja	Código Barras	€ / Ud.
Excéntrico	25545	90 Ø	36	8435195820539	4,32
	25547	110 Ø	36	8435195824537	3,87

CISTERNA E INODORO

Manguitos WC



GOMA MANGUITO



	Código	Medida	Caja	Código Barras	€ / Ud.
Superior	25548	90 Ø	1	8435195827897	2,32



	Código	Medida	Caja	Código Barras	€ / Ud.
Labiada	25549	90 Ø	1	8435195827903	1,34

TAPÓN MACHO ABS



Código	Medida	Caja	Código Barras	€ / Ud.
74007	3/8"	100	8435195812251	0,17
74005	1/2"	100	8435195812268	0,11
74006	3/4"	50	8435195812275	0,24

TAPÓN HEMBRA ABS



Código	Medida	Caja	Código Barras	€ / Ud.
74008	1/2"	250	8435195847697	0,54
74009	3/4"	200	8435195847703	0,63
74001	1"	150	8435195847680	0,97

CISTERNA E INODORO



TAPA INODORO UNIVERSAL

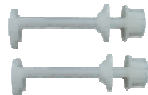
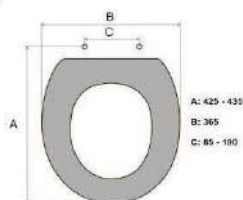

Código	Descripción	Caja	Código Barras	€ / Ud.
98097	PP	10	8435195801996	14,28

- Incluye juego de tornillos de fijación.
- Tapa de gran calidad, con diseño confortable, resistente y de fácil montaje.
- Con herraje regulable.
- Adaptable a la mayoría de inodoros comunes del mercado.

Recambio	Código	Descripción	Caja	Código Barras	€ / Ud.
	99248	Juego de tornillos	10	8435195822854	3,93

TAPA INODORO CONTINENTAL

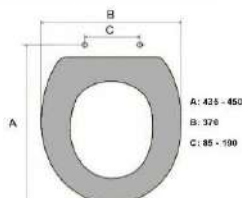

Código	Descripción	Caja	Código Barras	€ / Ud.
98098	PP	10	8435195812053	25,50

- Incluye juego de tornillos de fijación.
- Tapa de gran calidad, con diseño confortable, resistente y de fácil montaje.
- Con herraje de acero inoxidable y regulable.
- Adaptable a la mayoría de inodoros comunes del mercado.

Recambio	Código	Descripción	Caja	Código Barras	€ / Ud.
	98099	Juego de tornillos	10	8435195822861	6,72

TAPA INODORO LUCIAN

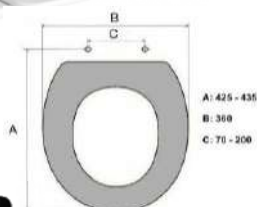

Código	Descripción	Caja	Código Barras	€ / Ud.
98090	ABS	10	8435195822878	32,83

- Incluye juego de tornillos de fijación.
- Tapa de gran calidad, con diseño confortable, resistente y de fácil montaje.
- Con herraje de acero inoxidable y regulable.
- Adaptable a la mayoría de inodoros comunes del mercado.

Recambio	Código	Descripción	Caja	Código Barras	€ / Ud.
	98091	Juego de tornillos	10	8435195822885	6,72

CISTERNA E INODORO



PORTAESCOBILLAS COMPLETO



Código	Descripción	Caja	Código Barras	€ / Ud.
98093	ABS	12	8435195822892	5,36

- Diponible en varios colores: blanco, beige, celeste y rosa.

ESCOBILLA



Código	Descripción	Caja	Código Barras	€ / Ud.
98094	ABS	1	8435195822908	2,49

TABURETE DE BAÑO



Código	Descripción	Caja	Código Barras	€ / Ud.
98095	ABS	1	8435195822915	24,02

- Diponible en varios colores: blanco, beige, celeste y rosa.

EJE PORTARROLLOS

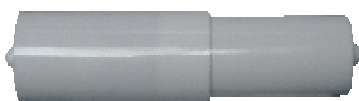

Código	Descripción	Caja	Código Barras	€ / Ud.
72019	ABS blanco	10	8435195826951	0,65



ACCESORIOS DE FIJACIÓN

Accesorios de fijación



170

ACCESORIOS DE FIJACIÓN



JUEGO 2 TORNILLOS FIJACIÓN INODORO / BIDET ACERO INOX.



Código	Medida	Caja	Código Barras	€ / Ud.
62001	M5 x 75 mm.	50	8435195841411	1,46

JUEGO 2 TORNILLOS FIJACIÓN INODORO / BIDET LATÓN

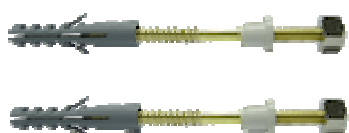

Código	Medida	Caja	Código Barras	€ / Ud.
62003	M5 x 75 mm.	50	8435195809534	0,99

JUEGO 2 TORNILLOS FIJACIÓN INODORO / BIDET ACERO



Código	Medida	Caja	Código Barras	€ / Ud.
62002	M5 x 75 mm.	50	8435195809527	0,51

JUEGO 4 TORNILLOS FIJACIÓN INODORO / BIDET ACERO



Código	Medida	Caja	Código Barras	€ / Ud.
62010	M5 x 75 mm.	25	8435195827873	0,96

JUEGO 2 TORNILLOS FIJACIÓN LATERAL INODORO



Código	Medida	Caja	Código Barras	€ / Ud.
99150	M6	25	8435195809565	1,39

JUEGO 2 TORNILLOS FIJACIÓN LATERAL INODORO CON EMBELLECEDOR



Código	Medida	Caja	Código Barras	€ / Ud.
99151	M6	25	8435195821352	1,86

JUEGO 2 TORNILLOS FIJACIÓN INODORO CON SOPORTE NYLON



Código	Medida	Caja	Código Barras	€ / Ud.
62015	M6	25	8435195847710	1,56

ACCESORIOS DE FIJACIÓN



JUEGO 2 TORNILLOS FIJACIÓN LAVABO ACERO



Código	Medida	Caja	Código Barras	€ / Ud.
62004	M8 x 90 mm.	25	8435195809541	1,05
62005	M10 x 100 mm.	25	8435195809558	0,88

JUEGO 2 TORNILLOS FIJACIÓN TAZA / TANQUE ACERO INOX



Código	Medida	Caja	Código Barras	€ / Ud.
62013	95 mm.	25	8435195809589	1,71

JUEGO 2 TORNILLOS FIJACIÓN TAZA / TANQUE ACERO



Código	Medida	Caja	Código Barras	€ / Ud.
62006	95 mm.	25	8435195809572	1,28

JUEGO 2 TORNILLOS FIJACIÓN TAZA / TANQUE NYLON

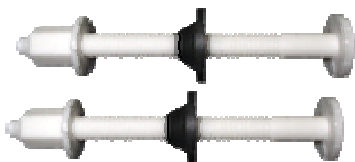

Código	Medida	Caja	Código Barras	€ / Ud.
62014	95 mm.	25	8435195822670	0,68

JUEGO 2 TORNILLOS FIJACIÓN SOPORTE CALENTADOR



Código	Medida	Caja	Código Barras	€ / Ud.
62007	M8 x 60 mm.	25	8435195809596	0,94
62008	M8 x 70 mm.	25	8435195809602	0,94

JUEGO 2 ESCUADRAS SOPORTE LAVABO



Código	Medida	Caja	Código Barras	€ / Ud.
63002	10 cm.	100	8435195809657	1,94
63003	12 cm.	100	8435195809664	2,38

TACOS ESTRIADOS DE NYLON



Código	Medida	Caja	Código Barras	€ / Ud.
62502	6 Ø	171	8435195809619	0,019
62504	8 Ø	171	8435195809626	0,024
62506	10 Ø	50	8435195809633	0,042
62508	12 Ø	50	8435195809640	0,077



RACORERÍA DE LATÓN ROSCAR

Machón doble		174
Marsella hexagonal		176
Reducción hexagonal		177
Reducción lisa		177
Codos		178
Te H-H-H		180
Manguitos		181
Tapón Hembra		182
Tapón Macho		183
Unión 3 piezas		184
Racor depósito uralita		185
Arandela acero y latón		185
Tuercas correderas		186
Alargaderas cilíndricas pulidas y cromadas		186
Codo 3 bocas, cruz 4 bocas, Te 5 vías		187
Bebedero de cerdo		187
Curvas de 90°		187
Collarines		188
Maguitos electrolíticos		188

RACORERÍA DE LATÓN ROSCAR



MACHÓN DOBLE M-M (TH280)



Código	Medida	Caja	Código Barras	€ / Ud.
66000	1/8"	100	8435195810202	0,43
66001	1/4"	100	8435195810219	0,59
66002	3/8"	100	8435195810226	0,67
66003	1/2"	100	8435195810233	0,92
66004	3/4"	25	8435195810240	1,42
66005	1"	25	8435195810257	2,42
66006	1 1/4"	10	8435195810264	4,97
66007	1 1/2"	10	8435195810271	5,99
66008	2"	5	8435195810288	8,75
66009	2 1/2"	2	8435195810295	19,30
66015	3"	2	8435195810301	22,98
66016	4"	2	8435195810318	76,93

MACHÓN DOBLE CROMADO M-M (TH280)



Código	Medida	Caja	Código Barras	€ / Ud.
66010	1/4"	100	8435195810325	0,65
66011	3/8"	100	8435195810332	0,79
66012	1/2"	100	8435195810349	1,14
66013	3/4"	50	8435195810356	1,45
66014	1"	25	8435195810363	2,14
66020	1 1/4"	5	8435195827033	3,93
66021	1 1/2"	5	8435195827040	5,65
66022	2"	5	8435195827057	7,72
66023	2 1/2"	1	8435195827064	16,35

MACHÓN DOBLE REDUCIDO M-M (TH245)



Código	Medida	Caja	Código Barras	€ / Ud.
67017	1/8" x 3/8"	100	8435195827071	0,94
67028	1/4" x 1/8"	100	8435195810370	0,69
67000	1/4" x 3/8"	100	8435195810387	0,99
67029	1/2" x 1/4"	100	8435195810394	1,27
67001	1/2" x 3/8"	100	8435195810400	1,05
67002	3/4" x 1/2"	25	8435195810417	1,62
67033	3/4" x 7/8"	25	8435195823226	2,28
67003	1" x 3/4"	50	8435195810424	2,24
67004	1 1/4" x 1"	10	8435195810431	3,34
67005	1 1/2" x 1 1/4"	10	8435195810448	6,72
67006	2" x 1 1/2"	5	8435195810455	10,16
67007	1" x 1/2"	25	8435195810462	2,82
67008	1 1/2" x 1/2"	10	8435195810479	4,92
67030	1 1/4" x 1/2"	10	8435195810486	3,43
67015	1 1/4" x 3/4"	10	8435195810493	3,20
67020	1 1/2" x 3/4"	10	8435195810509	5,93
67021	1 1/2" x 1"	10	8435195810516	6,38
67022	2" x 3/4"	5	8435195810523	7,12
67023	2" x 1"	5	8435195810530	7,12
67024	2" x 1 1/4"	5	8435195810547	9,89
67009	2 1/2" x 1 1/4"	2	8435195827088	21,75
67014	2 1/2" x 1 1/2"	2	8435195827095	17,95
67025	2 1/2" x 2"	2	8435195810554	17,95
67026	3" x 2"	2	8435195810561	22,93
67027	3" x 2 1/2"	2	8435195810578	26,15
67031	4" x 2 1/2"	2	8435195810585	73,81
67032	4" x 3"	2	8435195810592	84,23

RACORERÍA DE LATÓN ROSCAR



MACHÓN DOBLE REDUCIDO CROMADO M-M (TH245)



Código	Medida	Caja	Código Barras	€ / Ud.
67010	1/2" x 3/8"	100	8435195810608	1,05
67011	3/4" x 1/2"	100	8435195810615	1,85
67012	1" x 3/4"	50	8435195810622	2,54
67041	1 1/4" x 1"	5	8435195827101	3,62
67042	1 1/2" x 1 1/4"	5	8435195827118	5,65
67043	2 x 1 1/2"	5	8435195827125	8,80
67044	1 x 1/2"	5	8435195827132	2,21
67045	1 1/2" x 1/2"	5	8435195827149	4,86
67046	1 1/4" x 1/2"	5	8435195827156	3,98
67047	1 1/4" x 3/4"	5	8435195827163	3,70
67048	1 1/2" x 3/3"	5	8435195827170	4,89
67049	1 1/2" x 1"	5	8435195827187	6,62
67050	2" x 3/4"	5	8435195827194	7,98
67051	2" x 1"	5	8435195827200	7,98
67052	2 x 1 1/4"	5	8435195827217	8,56
67053	2 1/2" x 2"	5	8435195827224	14,67

MACHÓN MONOBLOC CROMADO M-M



Código	Medida	Caja	Código Barras	€ / Ud.
65502	1/2" x 3/8" 32 mm.	50	8435195810172	2,75

MACHÓN MONOBLOC MEDIA ROSCA M-M



Código	Medida	Caja	Código Barras	€ / Ud.
65507	1/2" x 3/8" 40 mm.	10	8435195810189	1,36

MACHÓN MONOBLOC MEDIA ROSCA CROMADO M-M



Código	Medida	Caja	Código Barras	€ / Ud.
65508	1/2" x 3/8" 40 mm.	25	8435195810196	1,55

MACHÓN MONOBLOC CON TUERCA Y BICONO CROMADO M-M



Código	Medida	Caja	Código Barras	€ / Ud.
65001	1/2" x 3/8"	50	8435195810141	1,55
65002	1/2" x 3/8" 32 mm.	50	8435195810158	2,11

RACORERÍA DE LATÓN ROSCAR



MARSELLA HEXAGONAL M-H (TH529)



Código	Medida	Caja	Código Barras	€ / Ud.
68001	3/8"	100	8435195810639	0,90
68002	1/2"	100	8435195810646	1,04
68003	1/2" x 2 cm.	100	8435195810653	1,50
68009	1/2" x 3 cm.	25	8435195810660	1,69
68016	1/2" HEXÁGONO INTERIOR	25	8435195810776	0,99
68004	3/4"	50	8435195810677	1,99
68005	1"	25	8435195810684	2,12
68006	1 1/4"	10	8435195810691	4,97
68007	1 1/2"	5	8435195810707	5,99
68008	2"	5	8435195810714	14,35

MARSELLA HEXAGONAL CROMADA M-H (TH529)



Código	Medida	Caja	Código Barras	€ / Ud.
68010	3/8"	50	8435195810721	1,16
68011	1/2"	100	8435195810738	1,27
68012	1/2" x 2 cm.	100	8435195810745	1,69
68013	3/4"	50	8435195810752	2,23
68014	1"	25	8435195810769	2,45

MARSELLA HEXAGONAL REDUCIDA M-H (TH246)



Código	Medida	Caja	Código Barras	€ / Ud.
69023	1/8" x 1/4"	100	8435195810783	1,97
69001	3/8" x 1/2"	100	8435195810790	0,99
69020	3/8" x 3/4"	100	8435195841978	1,61
69002	1/2" x 3/8"	100	8435195810806	0,78
69003	1/2" x 3/4"	100	8435195810813	1,83
98023	1/2" x 1"	25	8435195810820	2,22
69018	1/2" x 1 1/4"	10	8435195810837	6,50
69004	3/4" x 1/2"	50	8435195810844	2,09
69005	3/4" x 1"	25	8435195810851	2,84
69017	3/4" x 1 1/4"	10	8435195810875	4,48
69019	3/4" x 2"	5	8435195810912	11,37
69024	1" x 1/2"	5	8435195824681	2,99
69006	1" x 3/4"	25	8435195810868	4,35
69007	1" x 1 1/4"	10	8435195810882	6,56
69009	1" x 1 1/2"	5	8435195810899	7,76
69022	1" x 2"	5	8435195810929	13,65
69016	1 1/4" x 1 1/2"	5	8435195810905	6,60
90092	1 1/4" x 2"	5	8435195810936	13,60
99228	1 1/2" x 2"	5	8435195810943	13,89
69008	2" x 2 1/2"	5	8435195810950	23,36

MARSELLA HEXAGONAL REDUCIDA CROMADA M-H (TH246)



Código	Medida	Caja	Código Barras	€ / Ud.
69010	3/8" x 1/2"	100	8435195810967	1,09
69011	1/2" x 3/8"	100	8435195810974	0,94
69012	1/2" x 3/4"	100	8435195810981	1,88
69013	3/4" x 1/2"	25	8435195810998	2,05
69014	3/4" x 1"	25	8435195811001	3,14
69015	1" x 3/4"	25	8435195811018	4,28

RACORERÍA DE LATÓN ROSCAR



REDUCCIÓN HEXAGONAL M-H (TH241)



Código	Medida	Caja	Código Barras	€ / Ud.
99091	1/4" x 1/8"	100	8435195809831	0,62
64000	3/8" x 1/4"	100	8435195809848	0,65
64024	1/2" x 1/8"	100	8435195809855	1,35
64001	1/2" x 1/4"	100	8435195809862	1,10
64002	1/2" x 3/8"	100	8435195809879	0,86
64003	3/4" x 1/2"	100	8435195809886	1,36
64004	1" x 1/2"	50	8435195809893	2,72
64005	1" x 3/4"	50	8435195809909	1,92
64027	1 1/4" x 1/2"	10	8435195809916	4,08
64006	1 1/4" x 3/4"	10	8435195809923	4,35
64007	1 1/4" x 1"	10	8435195809930	2,99
64025	1 1/2" x 1/2"	10	8435195809947	4,35
64008	1 1/2" x 3/4"	10	8435195809954	5,21
64009	1 1/2" x 1"	10	8435195809961	4,97
64010	1 1/2" x 1 1/4"	10	8435195809978	3,35
64019	2" x 1/2"	10	8435195809985	5,96
64011	2" x 3/4"	10	8435195809992	7,96
64012	2" x 1"	10	8435195810004	8,67
64013	2" x 1 1/4"	10	8435195810011	8,48
64014	2" x 1 1/2"	10	8435195810028	7,31
64030	2 1/2" x 3/4"	1	8435195823165	18,93
64031	2 1/2" x 1"	1	8435195823172	18,93
64033	2 1/2" x 1 1/4"	1	8435195823189	18,93
64034	2 1/2" x 1 1/2"	1	8435195823196	19,76
64015	2 1/2" x 2"	5	8435195810035	18,92
64035	3" x 1 1/4"	1	8435195823202	28,72
64016	3" x 2"	5	8435195810042	23,96
64017	3" x 2 1/2"	5	8435195810059	23,96
64037	4 x 2"	1	8435195828269	60,54
64028	4" x 2 1/2"	1	8435195810066	60,54
64029	4" x 3"	1	8435195810073	69,59

REDUCCIÓN LISA M-H



Código	Medida	Caja	Código Barras	€ / Ud.
64020	3/8" x 1/4"	100	8435195810080	0,80
64021	1/2" x 3/8"	100	8435195810097	0,69
64042	7/8" x 3/4"	100	8435195841671	1,43
64022	3/4" x 1/2"	100	8435195810103	1,57
64041	1" x 1/2"	50	8435195841664	2,45
64023	1" x 3/4"	50	8435195810110	1,41

RACORERÍA DE LATÓN ROSCAR



CODO H-H (TH90)



Código	Medida	Caja	Código Barras	€ / Ud.
46001	1/4"	25	8435195847925	2,15
46002	3/8"	50	8435195804638	2,19
46003	1/2"	50	8435195804645	2,57
46004	3/4"	25	8435195804652	3,57
46005	1"	10	8435195804669	4,98
46006	1 1/4"	10	8435195804676	8,92
46007	1 1/2"	10	8435195804683	11,75
46008	2"	5	8435195804690	19,64
46009	2 1/2"	2	8435195804706	34,95
46010	3"	2	8435195804713	54,23
46011	4"	2	8435195804720	126,15

CODO CROMADO H-H (TH90)



Código	Medida	Caja	Código Barras	€ / Ud.
46012	3/8"	50	8435195804737	2,26
46013	1/2"	25	8435195804744	2,74
46014	3/4"	25	8435195804751	3,99
46015	1"	10	8435195804768	5,16

CODO REDUCIDO H-H (TH90/R)



Código	Medida	Caja	Código Barras	€ / Ud.
46032	3/8" x 1/2"	50	8435195804775	1,98
46033	1/2" x 3/4"	25	8435195804782	1,99
46034	3/4" x 1"	5	8435195804799	2,86
46035	1/2" x 1"	5	8435195804805	3,18

CODO REDUCIDO CROMADO H-H (TH90/R)



Código	Medida	Caja	Código Barras	€ / Ud.
46037	3/8" x 1/2"	50	8435195804812	2,60
46038	1/2" x 3/4"	25	8435195804829	2,80
46039	3/4" x 1"	10	8435195804836	3,70

RACORERÍA DE LATÓN ROSCAR



CODO M-H (TH92)



Código	Medida	Caja	Código Barras	€ / Ud.
47002	3/8"	50	8435195804867	1,56
47003	1/2"	50	8435195804874	1,99
47004	3/4"	25	8435195804881	3,50
47005	1"	10	8435195804898	5,30
47006	1 1/4"	10	8435195804904	9,88
47007	1 1/2"	10	8435195804911	11,81
47008	2"	5	8435195804928	16,98
47009	2 1/2"	2	8435195804935	28,98
47010	3"	2	8435195804942	62,70
47011	4"	2	8435195804959	129,33

CODO CROMADO M-H (TH92)



Código	Medida	Caja	Código Barras	€ / Ud.
47012	3/8"	50	8435195804966	1,79
47013	1/2"	25	8435195804973	2,16
47014	3/4"	25	8435195804980	3,68
47015	1"	10	8435195804997	4,56

CODO REDUCIDO M-H (TH92/R)



Código	Medida	Caja	Código Barras	€ / Ud.
47032	1/2" x 3/4"	25	8435195805000	3,79
47033	3/4" x 1"	10	8435195805017	7,08
47034	1" x 1 1/4"	5	8435195805024	13,28

CODO REDUCIDO CROMADO M-H (TH92/R)



Código	Medida	Caja	Código Barras	€ / Ud.
47037	1/2" x 3/4"	25	8435195805031	4,11
47038	3/4" x 1"	10	8435195805048	7,62
47039	1" x 1 1/4"	5	8435195805055	14,98

RACORERÍA DE LATÓN ROSCAR



TE H-H-H (TH130)



Código	Medida	Caja	Código Barras	€ / Ud.
45001	1/4"	10	8435195826968	2,45
45002	3/8"	50	8435195804492	1,89
45003	1/2"	50	8435195804508	2,82
45004	3/4"	25	8435195804515	3,63
45005	1"	10	8435195804522	5,88
45006	1 1/4"	5	8435195804539	8,58
45007	1 1/2"	5	8435195804546	15,68
45008	2"	5	8435195804553	23,15
45009	2 1/2"	2	8435195804560	39,69
45010	3"	2	8435195804577	72,20
45011	4"	2	8435195804584	116,74

TE CROMADA H-H-H (TH130)



Código	Medida	Caja	Código Barras	€ / Ud.
45012	3/8"	50	8435195804591	1,89
45013	1/2"	25	8435195804607	2,66
45014	3/4"	25	8435195804614	3,57
45015	1"	10	8435195804621	6,58

TE REDUCIDA H-H-H (TH130)



Código	Medida	Caja	Código Barras	€ / Ud.
45016	3/4" x 1/2" x 3/4"	1	8435195833133	2,90
45021	3/4" x 3/4" x 1/2"	1	8435195833140	6,15
45017	1" x 3/4" x 1"	1	8435195833157	4,16
45018	1" x 1/2" x 1"	1	8435195833164	3,98
45019	1 1/4" x 1/2" x 1 1/4"	1	8435195833171	6,98
45020	1 1/4" x 3/4" x 1 1/4"	1	8435195833188	10,51
45037	1 1/4" x 1" x 1 1/4"	1	8435195833195	7,18
45032	1 1/2" x 1/2" x 1 1/2"	1	8435195833201	10,24
45035	1 1/2" x 3/4" x 1 1/2"	1	8435195833218	8,75
45024	1 1/2" x 1" x 1 1/2"	1	8435195833225	8,74
45027	1 1/2" x 1 1/4" x 1 1/2"	1	8435195833232	8,75
45036	2" x 3/4" x 2"	1	8435195833249	14,97
45033	2" x 1 1/4" x 2"	1	8435195833256	14,97
45034	2" x 1 1/2" x 2"	1	8435195833263	14,97

RACORERÍA DE LATÓN ROSCAR



MANGUITO H-H (TH270)



Código	Medida	Caja	Código Barras	€ / Ud.
48001	1/4"	50	8435195838107	2,41
48002	3/8"	50	8435195805222	1,36
48003	1/2"	50	8435195805239	1,65
48004	3/4"	25	8435195805246	1,98
48005	1"	10	8435195805253	3,32
48006	1 1/4"	5	8435195805260	5,05
48007	1 1/2"	5	8435195805277	8,22
48008	2"	5	8435195805284	10,47
48009	2 1/2"	2	8435195805291	22,99
48010	3"	2	8435195805307	29,97
48011	4"	2	8435195805314	55,36

MANGUITO CROMADO H-H (TH270)



Código	Medida	Caja	Código Barras	€ / Ud.
48012	3/8"	50	8435195805321	1,43
48013	1/2"	50	8435195805338	2,08
48014	3/4"	25	8435195805345	2,26
48015	1"	10	8435195805352	5,10

MANGUITO REDUCIDO H-H (TH240)



Código	Medida	Caja	Código Barras	€ / Ud.
48017	3/8" x 1/2"	50	8435195805369	1,72
48018	1/2" x 3/4"	25	8435195805376	2,53
48065	1/2" x 1"	25	8435195848090	3,99
48019	3/4" x 1"	10	8435195805383	3,75
48020	1" x 1 1/4"	10	8435195805390	3,99
48024	1" x 2"	5	8435195805437	6,91
48021	1 1/4" x 1 1/2"	5	8435195805406	4,85
48023	1 1/4" x 2"	5	8435195805420	7,36
48022	1 1/2" x 2"	5	8435195805413	8,45
48025	2 1/2" x 2"	1	8435195826999	15,66
48029	3" x 2"	1	8435195838114	34,47

MANGUITO REDUCIDO CROMADO H-H (TH240)



Código	Medida	Caja	Código Barras	€ / Ud.
48026	3/8" x 1/2"	50	8435195805444	1,70
48027	1/2" x 3/4"	50	8435195805451	2,25
48028	3/4" x 1"	25	8435195805468	3,22

RACORERÍA DE LATÓN ROSCAR



TAPÓN HEMBRA (TH300)



Código	Medida	Caja	Código Barras	€ / Ud.
70000	1/8"	100	8435195811384	0,36
70001	1/4"	100	8435195811391	0,50
70002	3/8"	100	8435195811407	0,55
70003	1/2"	100	8435195811414	0,61
70004	3/4"	50	8435195811421	1,05
70005	1"	25	8435195811438	1,58
70006	1 1/4"	10	8435195811445	3,92
70007	1 1/2"	10	8435195811452	3,63
70008	2"	5	8435195811469	5,22
70009	2 1/2"	2	8435195811476	14,31
70010	3"	2	8435195811483	22,64
70011	4"	2	8435195811490	33,66

TAPÓN HEMBRA CROMADO (TH300)



Código	Medida	Caja	Código Barras	€ / Ud.
70018	3/8"	25	8435195827231	0,49
70019	1/2"	25	8435195827248	0,71
70020	3/4"	10	8435195827255	0,99
70021	1"	5	8435195827262	1,05

TAPÓN HEMBRA CON PRECINTO PARA GAS



Código	Medida	Caja	Código Barras	€ / Ud.
70014	1/2"	100	8435195800906	0,90
70015	3/4"	50	8435195827279	1,25
70016	1"	25	8435195827286	1,78
70017	7/8"	25	8435195827293	2,51

RACORERÍA DE LATÓN ROSCAR



TAPÓN MACHO (TH290)



Código	Medida	Caja	Código Barras	€ / Ud.
70500	1/8"	100	8435195811506	0,45
70501	1/4"	100	8435195811513	0,52
70502	3/8"	100	8435195811520	0,76
70503	1/2"	100	8435195811537	0,94
70504	3/4"	50	8435195811544	1,35
70505	1"	25	8435195811551	2,44
70506	1 1/4"	10	8435195811568	3,70
70507	1 1/2"	10	8435195811575	3,34
70508	2"	5	8435195811582	7,29
70509	2 1/2"	1	8435195811599	15,17
70510	3"	1	8435195811605	19,74
70511	4"	1	8435195811612	40,50

TAPÓN MACHO CROMADO (TH290)



Código	Medida	Caja	Código Barras	€ / Ud.
70512	3/8"	25	8435195827309	0,77
70513	1/2"	25	8435195827316	1,05
70514	3/4"	25	8435195827323	1,11
70520	1"	5	8435195827330	1,94

TAPÓN MACHO CON PRECINTO PARA GAS



Código	Medida	Caja	Código Barras	€ / Ud.
70515	1/2"	100	8435195828054	0,99
70516	3/4"	50	8435195828061	1,61
70518	1"	25	8435195828078	2,26
70519	7/8"	25	8435195828085	2,19

RACORERÍA DE LATÓN ROSCAR



UNIÓN 3 PIEZAS H-H CIERRE CÓNICO (TH340)



Código	Medida	Caja	Código Barras	€ / Ud.
69501	1/2"	10	8435195811032	6,85
69502	3/4"	10	8435195811049	9,18
69503	1"	5	8435195811056	11,75
69504	1 1/4"	5	8435195811063	13,10
69505	1 1/2"	2	8435195811070	21,79
69506	2"	2	8435195811087	22,63
69507	2 1/2"	1	8435195824339	66,37
69508	3"	1	8435195827347	99,98
69509	4"	1	8435195827354	298,08

UNIÓN 3 PIEZAS H-H CIERRE JUNTA PLANA



Código	Medida	Caja	Código Barras	€ / Ud.
69581	1/2"	10	8435195833270	4,79
69582	3/4"	10	8435195833287	7,15
69583	1"	5	8435195833294	16,73
69584	1 1/4"	2	8435195833300	17,68
69585	1 1/2"	2	8435195833317	30,36
69586	2"	1	8435195833324	28,24

UNIÓN 3 PIEZAS M-H CIERRE CÓNICO (TH341)



Código	Medida	Caja	Código Barras	€ / Ud.
69510	1/2"	10	8435195811094	4,95
69511	3/4"	10	8435195811100	8,21
69512	1"	5	8435195811117	14,68
69513	1 1/4"	5	8435195811124	18,65
69514	1 1/2"	2	8435195811131	24,19
69515	2"	2	8435195811148	33,66
69516	2 1/2"	1	8435195824346	99,10

UNIÓN 3 PIEZAS M-H CIERRE JUNTA PLANA



Código	Medida	Caja	Código Barras	€ / Ud.
69591	1/2"	10	8435195833331	5,33
69592	3/4"	10	8435195833348	8,55
69593	1"	5	8435195833355	14,49
69594	1 1/4"	5	8435195833362	18,16
69595	1 1/2"	2	8435195833379	20,42
69596	2"	2	8435195833386	27,88

RACORERÍA DE LATÓN ROSCAR



RACOR DEPÓSITO URALITA CON TUERCA CORREDERA



Código	Medida	Caja	Código Barras	€ / Ud.
59402	3/8"	25	8435195808636	1,96
59403	1/2"	25	8435195808643	2,70
59404	3/4"	15	8435195808650	4,55
59405	1"	10	8435195808667	6,10
59406	1 1/4"	6	8435195808674	8,58
59407	1 1/2"	5	8435195808681	9,88
59408	2"	2	8435195808698	16,15
59409	2 1/2"	2	8435195808704	52,53
59410	3"	2	8435195808711	59,17

RACOR DEPÓSITO URALITA CON TUERCA CORREDERA Y TUBO



Código	Medida	Caja	Código Barras	€ / Ud.
59603	1/2"	25	8435195808728	3,70
59604	3/4"	25	8435195808735	5,71
59605	1"	10	8435195808742	8,08
59606	1 1/4"	6	8435195808759	12,70
59607	1 1/2"	4	8435195808766	17,37
59608	2"	2	8435195808773	28,51
59609	2 1/2"	2	8435195808780	68,99
59610	3"	2	8435195808797	125,10

ARANDELA DE ACERO CINCADO



Código	Medida	Caja	Código Barras	€ / Ud.
59615	3/8" x 38	100	8435195808803	0,16
59616	1/2" x 45	100	8435195808810	0,18
59617	3/4" x 55	100	8435195808827	0,22
59618	1" x 66	50	8435195808834	0,24
59619	1 1/4" x 66	50	8435195808841	0,45
59620	1 1/2" x 78	50	8435195808858	0,47
59621	2" x 88	50	8435195808865	0,59

ARANDELA DE LATÓN



Código	Medida	Caja	Código Barras	€ / Ud.
59625	1/2" x 45	100	8435195808889	1,12
59626	3/4" x 55	100	8435195808896	1,29
59627	1" x 66	50	8435195808902	1,87
59628	1 1/4" x 66	50	8435195808919	2,43
59629	1 1/2" x 78	50	8435195808926	2,68
59630	2" x 88	50	8435195808933	3,23

ARANDELA DE ACERO INOX.



Código	Medida	Caja	Código Barras	€ / Ud.
59634	3/8" x 38	100	8435195841213	0,32
59635	1/2" x 45	100	8435195841220	0,45
59636	3/4" x 55	50	8435195841237	0,55
59637	1" x 66	50	8435195847888	0,60
59638	1 1/4" x 66	50	8435195847895	1,15
59639	1 1/2" x 78	50	8435195847901	1,22
59640	2" x 88	50	8435195847918	1,35

RACORERÍA DE LATÓN ROSCAR



TUERCA CORREDERA CON VALONA



Código	Medida	Caja	Código Barras	€ / Ud.
69519	3/8"	100	8435195811155	0,48
69520	1/2"	100	8435195811162	0,59
69521	3/4"	100	8435195811179	0,89
69522	1"	50	8435195811186	0,88
69523	1 1/4"	25	8435195811193	1,65
69524	1 1/2"	25	8435195811209	2,24
69525	2"	25	8435195811216	5,70
69526	2 1/2"	10	8435195811223	9,63
69527	3"	10	8435195811230	12,22
99329	28/150	100	8435195847185	0,80

ALARGADERA CILÍNDRICA PULIDA M-H (TH526)



Código	Medida	Caja	Código Barras	€ / Ud.
58900	3/8" x 30 mm.	25	8435195825664	1,98
58901	3/8" x 50 mm.	50	8435195808452	2,95
58902	3/8" x 100 mm.	50	8435195808469	6,82

59001	1/2" x 10 mm.	50	8435195808476	1,25
59002	1/2" x 20 mm.	50	8435195808483	2,71
59003	1/2" x 30 mm.	50	8435195808490	1,98
59006	1/2" x 40 mm.	25	8435195825671	2,87
59004	1/2" x 50 mm.	25	8435195808506	2,28
59008	1/2" x 60 mm.	25	8435195825688	4,60
59009	1/2" x 70 mm.	25	8435195825695	5,16
59010	1/2" x 80 mm.	25	8435195825701	8,19
59005	1/2" x 100 mm.	10	8435195808513	3,65

59011	3/4" x 50 mm.	10	8435195808520	4,40
59012	3/4" x 100 mm.	5	8435195808537	7,22

ALARGADERA CILÍNDRICA CROMADA M-H (TH526)



Código	Medida	Caja	Código Barras	€ / Ud.
59100	3/8" x 30 mm.	25	8435195825718	2,30
59101	3/8" x 50 mm.	50	8435195808544	3,65
59102	3/8" x 100 mm.	50	8435195808551	5,49

59201	1/2" x 10 mm.	50	8435195808568	2,10
59202	1/2" x 20 mm.	50	8435195808575	2,62
59203	1/2" x 30 mm.	50	8435195808582	2,88
59206	1/2" x 40 mm.	25	8435195825725	3,99
59204	1/2" x 50 mm.	25	8435195808599	2,93
59208	1/2" x 60 mm.	25	8435195825732	6,67
59209	1/2" x 70 mm.	25	8435195825756	5,48
59210	1/2" x 80 mm.	25	8435195825763	7,25
59205	1/2" x 100 mm.	10	8435195808605	3,85

59211	3/4" x 50 mm.	10	8435195808612	3,96
59212	3/4" x 100 mm.	5	8435195808629	6,50

RACORERÍA DE LATÓN ROSCAR



CODO 3 BOCAS H (TH221)



Código	Medida	Caja	Código Barras	€ / Ud.
46016	1/2"	10	8435195804843	3,78
46017	3/4"	15	8435195804850	6,52

CRUZ 4 BOCAS H (TH180)



Código	Medida	Caja	Código Barras	€ / Ud.
48501	3/8"	10	8435195827002	2,62
48502	1/2"	10	8435195805741	5,83
48503	3/4"	10	8435195805758	7,58
48504	1"	5	8435195805765	11,55
48505	1 1/4"	2	8435195805772	12,52
48506	1 1/2"	2	8435195805789	21,82
48507	2"	2	8435195805796	30,98
48508	2 1/2"	1	8435195827019	152,37
48509	3"	1	8435195827026	144,50

RACOR TE 5 VÍAS



Código	Medida	Caja	Código Barras	€ / Ud.
47101	1" x 1" x 1" x 1/4" x 81 mm.	5	8435195805208	6,96
47102	1" x 1" x 1" x 1/4" x 92 mm.	5	8435195805215	10,68
47103	1" x 1" x 1" x 1/4" x 120 mm.	5	8435195833836	15,48

BEBEDERO DE CERDO



Código	Medida	Caja	Código Barras	€ / Ud.
99354	1/2"	25	8435195811025	2,87

CURVA 90° M-H (TH1)



Código	Medida	Caja	Código Barras	€ / Ud.
47016	1/2"	10	8435195805062	6,62
47017	3/4"	10	8435195805079	6,75
47018	1"	5	8435195805086	8,99
47019	1 1/4"	3	8435195805093	14,98
47020	1 1/2"	3	8435195805109	18,15
47021	2"	2	8435195805116	29,98

CURVA 90° H-H (TH2)



Código	Medida	Caja	Código Barras	€ / Ud.
47022	1/2"	10	8435195805123	4,25
47023	3/4"	10	8435195805130	6,75
47024	1"	5	8435195805147	13,20
47025	1 1/4"	3	8435195805154	15,51
47026	1 1/2"	3	8435195805161	19,75
47027	2"	3	8435195805178	31,98
47028	2 1/2"	2	8435195805185	53,10
47029	3"	2	8435195805192	132,62

RACORERÍA DE LATÓN ROSCAR



COLLARÍN TOMA CON JUNTA



Código	Medida	Caja	Código Barras	€ / Ud.
48030	1/2" x 20	25	8435195805475	5,88
48031	1/2" x 25	25	8435195805482	6,44
48032	1/2" x 32	15	8435195805499	13,60
48033	1/2" x 40	10	8435195805505	21,10
48034	1/2" x 50	5	8435195805512	20,45
48035	1/2" x 63	5	8435195805529	15,98
48036	1/2" x 75	2	8435195805536	28,86
48037	1/2" x 90	2	8435195805543	28,29
48038	3/4" x 40	10	8435195805550	12,74
48039	3/4" x 50	5	8435195805567	20,55
48040	3/4" x 63	5	8435195805574	16,27
48041	3/4" x 75	2	8435195805581	30,05
48042	3/4" x 90	2	8435195805598	28,16
48043	1" x 63	2	8435195805604	34,25
48044	1" x 75	2	8435195805611	27,52
48045	1" x 90	2	8435195805628	28,91

COLLARÍN CIEGO CON JUNTA



Código	Medida	Caja	Código Barras	€ / Ud.
48050	1/2" x 20	25	8435195805635	8,55
48051	3/4" x 25	25	8435195805642	6,56
48052	1" x 32	15	8435195805659	8,73
48053	1 1/4" x 40	10	8435195805666	10,88
48054	1 1/2" x 50	5	8435195805673	24,47
48055	2" x 63	2	8435195805680	28,30
48056	2 1/2" x 75	2	8435195805697	36,38
48057	3" x 90	2	8435195805703	27,25

MANGUITO ELECTROLÍTICO H-H Con fibra de vidrio

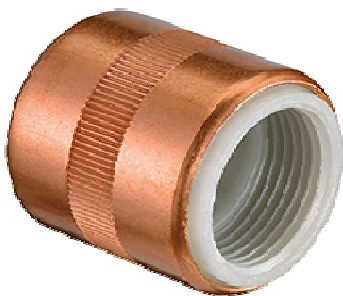

Código	Medida	Caja	Código Barras	€ / Ud.
72503	1/2"	25	8435195812060	2,43
72504	3/4"	25	8435195812077	3,75
72505	1"	10	8435195812084	6,25
72506	1 1/4"	8	8435195812091	13,20
72507	1 1/2"	6	8435195812107	17,98
72508	2"	4	8435195812114	36,85
72509	2 1/2"	2	8435195812121	46,96
72510	3"	2	8435195812138	96,03
72514	4"	2	8435195812145	90,19

MANGUITO ELECTROLÍTICO M-H Con fibra de vidrio

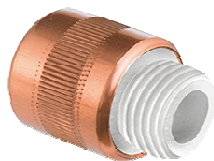

Código	Medida	Caja	Código Barras	€ / Ud.
72602	1/2"	25	8435195826975	2,57
72603	3/4"	25	8435195826982	4,29





MANGUITO ELECTROLÍTICO M-H



Código	Medida	Caja	Código Barras	€ / Ud.
72601	1/2"	25	8435195812152	1,43



RACORERÍA DE LATÓN SOLDAR

Codos		190
Enlaces y entronques		191
Te H		192
Tapones		192
Curva desviación		192

RACORERÍA DE LATÓN SOLDAR



CODO HEMBRA (90GCu)



Código	Medida	Caja	Código Barras	€ / Ud.
49007	3/8" x 15 Ø	25	8435195805802	1,20
49011	1/2" x 12 Ø	25	8435195805819	1,95
49001	1/2" x 15 Ø	25	8435195805826	1,62
49028	1/2" x 16 Ø	25	8435195838534	1,66
49003	1/2" x 18 Ø	25	8435195805833	1,92
49008	1/2" x 22 Ø	25	8435195805840	1,92
49009	3/4" x 15 Ø	25	8435195805857	2,77
49004	3/4" x 18 Ø	25	8435195805864	2,80
49005	3/4" x 22 Ø	25	8435195805871	2,81
49012	3/4" x 28 Ø	10	8435195821192	3,95
49010	1" x 22 Ø	10	8435195805888	4,16
49006	1" x 28 Ø	10	8435195805895	7,62
49013	1 1/4" x 28 Ø	5	8435195821208	8,05
49002	1 1/4" x 35 Ø	5	8435195821215	10,99
49014	1 1/2" x 42 Ø	5	8435195821222	13,54
49000	2" x 54 Ø	2	8435195821239	21,38

CODO MACHO (92GCu)



Código	Medida	Caja	Código Barras	€ / Ud.
49026	1/2" x 12 Ø	25	8435195838510	1,28
49015	1/2" x 15 Ø	25	8435195805901	1,53
49016	1/2" x 18 Ø	25	8435195805918	1,56
49017	1/2" x 22 Ø	25	8435195805925	1,94
49018	3/4" x 18 Ø	25	8435195805932	1,72
49019	3/4" x 22 Ø	25	8435195805949	2,55
49020	1" x 28 Ø	10	8435195805956	5,28

CODO MURAL (472GCu)



Código	Medida	Caja	Código Barras	€ / Ud.
49035	1/2" x 12 Ø	25	8435195805963	2,24
49031	1/2" x 15 Ø	25	8435195805970	2,82
49032	1/2" x 18 Ø	25	8435195805987	3,18
49037	3/4" x 18 Ø	25	8435195838558	3,57
49033	3/4" x 22 Ø	25	8435195805994	4,87
49034	1" x 28 Ø	10	8435195806007	12,54

RACORERÍA DE LATÓN SOLDAR



ENLACE HEMBRA (270GCu)



Código	Medida	Caja	Código Barras	€ / Ud.
49085	3/8" x 12 Ø	25	8435195806281	0,57
49079	3/8" x 15 Ø	25	8435195806298	0,72
49077	1/2" x 10 Ø	25	8435195806304	0,91
49078	1/2" x 12 Ø	25	8435195806311	1,20
49071	1/2" x 15 Ø	25	8435195806328	0,80
49072	1/2" x 18 Ø	25	8435195806335	1,17
49073	1/2" x 22 Ø	25	8435195806342	2,31
49080	3/4" x 15 Ø	25	8435195806359	1,43
49074	3/4" x 18 Ø	25	8435195806366	1,92
49075	3/4" x 22 Ø	25	8435195806373	2,11
49084	3/4" x 28 Ø	10	8435195806380	2,32
49082	1" x 22 Ø	10	8435195806397	1,99
49076	1" x 28 Ø	10	8435195806403	2,56
49081	1 1/4" x 28 Ø	5	8435195806410	5,39
49083	1 1/4" x 35 Ø	5	8435195806427	6,79
49088	1 1/2" x 42 Ø	5	8435195806434	6,98
49022	1 1/2" x 54 Ø	5	8435195823219	10,42
49087	2" x 54 Ø	2	8435195806441	10,11

ENTRONQUE MACHO (243GCu)



Código	Medida	Caja	Código Barras	€ / Ud.
49052	3/8" x 10 Ø	25	8435195806090	0,62
49068	3/8" x 12 Ø	25	8435195806106	0,61
49027	3/8" x 14 Ø	25	8435195838527	0,70
49036	3/8" x 15 Ø	25	8435195806113	0,56
49061	1/2" x 12 Ø	25	8435195806120	0,85
49024	1/2" x 14 Ø	25	8435195838503	0,79
49055	1/2" x 15 Ø	25	8435195806137	0,74
49056	1/2" x 18 Ø	25	8435195806144	0,72
49057	1/2" x 22 Ø	25	8435195806151	1,99
49062	3/4" x 15 Ø	25	8435195806168	1,36
49058	3/4" x 18 Ø	25	8435195806175	2,34
49059	3/4" x 22 Ø	25	8435195806182	2,19
49067	3/4" x 28 Ø	25	8435195806199	3,10
49064	1" x 22 Ø	10	8435195806205	2,25
49060	1" x 28 Ø	10	8435195806212	3,55
49039	1" x 35 Ø	10	8435195838572	4,30
49063	1 1/4" x 28 Ø	5	8435195806229	4,22
49065	1 1/4" x 35 Ø	5	8435195806236	6,13
49070	1 1/4" x 42 Ø	5	8435195806243	3,99
49054	1 1/2" x 35 Ø	5	8435195821284	4,35
49066	1 1/2" x 42 Ø	5	8435195806250	4,69
49086	2" x 54 Ø	2	8435195806267	7,59
49069	2 1/2" x 64 Ø	2	8435195806274	37,70
49089	3" x 76 Ø	1	8435195821291	34,70

RACORERÍA DE LATÓN SOLDAR



TE HEMBRA (130GCu)



Código	Medida	Caja	Código Barras	€ / Ud.
49090	3/8" x 12 Ø	25	8435195838602	1,58
49040	3/8" x 15 Ø	25	8435195838589	1,58
49047	1/2" x 12 Ø	25	8435195806014	2,40
49041	1/2" x 15 Ø	25	8435195806021	1,59
49042	1/2" x 18 Ø	25	8435195806038	2,44
49043	1/2" x 22 Ø	25	8435195806045	3,80
49044	3/4" x 18 Ø	25	8435195806052	2,85
49045	3/4" x 22 Ø	25	8435195806069	6,30
49048	3/4" x 28 Ø	10	8435195806076	5,68
49049	1" x 22 Ø	10	8435195821246	4,98
49046	1" x 28 Ø	10	8435195806083	9,73
49025	1 1/4" x 35 Ø	5	8435195821253	16,93
49050	1 1/2" x 42 Ø	5	8435195821260	32,33
49051	2" x 54 Ø	2	8435195821277	30,86

TAPÓN LATÓN (310GCu)



Código	Medida	Caja	Código Barras	€ / Ud.
49091	12 Ø	25	8435195806458	0,34
49092	15 Ø	25	8435195806465	0,62
49093	18 Ø	25	8435195806472	0,63
49094	22 Ø	25	8435195806489	0,80

CURVA DESVIACIÓN (85GCu)



Código	Medida	Caja	Código Barras	€ / Ud.
99360	15 x 15 Ø	10	8435195806496	5,26
99707	18 x 18 Ø	10	8435195806502	5,98
98051	22 x 22 Ø	10	8435195806519	8,98



RACORERÍA DE LATÓN PARA RIEGO

Lanza manguera 3 efectos		194
Entronques, manguitos y te manguera		194
Racor manguera 2 piezas		195
Colzadas riego y juntas		195
Válvula esfera riego		195
Racor rápido "Barcelona" y juntas		196
Te M, Te H, Te lisa		197
Boquillas		197

RACORERÍA DE LATÓN PARA RIEGO



LANZA MANGUERA 3 EFECTOS



Código	Medida	Caja	Código Barras	€ / Ud.
99122	16 mm. Ø	1	8435195822922	12,95
99123	20 mm. Ø	1	8435195822939	9,76
99124	25 mm. Ø	1	8435195822946	12,59

ENTRONQUE MANGUERA MACHO



Código	Medida	Caja	Código Barras	€ / Ud.
69530	3/8" x 13 mm.	25	8435195811247	1,69
69531	1/2" x 17 mm.	25	8435195811254	1,93
69532	3/4" x 22 mm.	25	8435195811261	2,83
69533	1" x 29 mm.	10	8435195811278	3,97
69534	1 1/4" x 34 mm.	5	8435195811285	6,31
69535	1 1/2" x 43 mm.	5	8435195811292	8,97
69536	2" x 55 mm.	1	8435195811308	13,20
69560	2 1/2" x 56 mm.	1	8435195827408	15,10
69537	3" x 75 mm.	1	8435195811315	33,62
69561	4" x 102 mm.	1	8435195827415	63,00

ENTRONQUE MANGUERA MACHO REFORZADO



Código	Medida	Caja	Código Barras	€ / Ud.
69562	1" x 27 mm.	10	8435195842067	3,62
69554	1 1/4" x 38 mm.	5	8435195842036	5,63
69555	1 1/2" x 43 mm.	5	8435195842043	9,89
69563	2" x 50 mm.	1	8435195842074	25,22
69556	2" x 57 mm.	1	8435195842050	14,93

MANGUITO EMPALME MANGUERA



Código	Medida	Caja	Código Barras	€ / Ud.
99111	3/8"	10	8435195817119	3,98
99112	1/2"	10	8435195817126	5,22
99113	3/4"	10	8435195817133	8,06
99114	1"	10	8435195817140	10,63
99115	1 1/4"	10	8435195817157	16,86

TE EMPALME MANGUERA



Código	Medida	Caja	Código Barras	€ / Ud.
99118	3/8"	10	8435195817164	5,03
99119	1/2"	10	8435195817171	5,85
99120	3/4"	10	8435195817188	9,94
99121	1"	10	8435195817195	16,61

RACORERÍA DE LATÓN PARA RIEGO



RACOR MANGUERA 2 PIEZAS



Código	Medida	Caja	Código Barras	€ / Ud.
69801	3/8"	25	8435195821413	3,29
69802	1/2"	25	8435195811322	2,07
69803	3/4"	25	8435195811339	2,18
69804	1"	5	8435195811346	4,72
69805	1 1/4"	5	8435195811353	13,44
69806	1 1/2"	2	8435195811360	15,19
69807	2"	2	8435195811377	14,46

COLZADA RIEGO TIPO "MADRID"



Código	Descripción	Caja	Código Barras	€ / Ud.
48092	Curva	10	8435195805727	99,98

Código	Descripción	Caja	Código Barras	€ / Ud.
48091	Recta	10	8435195805710	87,75

JUNTA COLZADA RIEGO

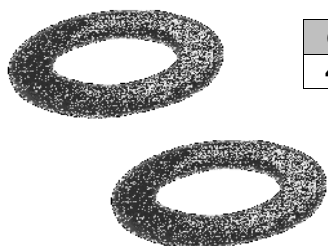

Código	Medida	Caja	Código Barras	€ / Ud.
48093	Única	10	8435195805734	1,18

VÁLVULA ESFERA RIEGO

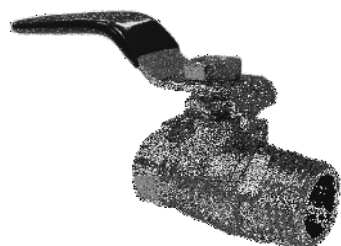

Código	Medida	Caja	Código Barras	€ / Ud.
990111	M 1/2" x H 3/8"	100	8435195817102	5,37

RACORERÍA DE LATÓN PARA RIEGO



RACOR RÁPIDO MACHO TIPO "BARCELONA"



Código	Medida	Caja	Código Barras	€ / Ud.
69621	M 1/2" x M 1/2"	10	8435195823103	3,98
69622	M 3/4" x M 3/4"	10	8435195823110	6,24
69623	M 1" x M 1"	5	8435195823127	9,21
69624	M 1 1/4" x M 1 1/4"	5	8435195823134	21,97
69625	M 1 1/2" x M 1 1/2"	2	8435195823141	28,99
69626	M 2" x M 2"	2	8435195823158	43,36

RACOR RÁPIDO MANGUERA TIPO "BARCELONA"



Código	Medida	Caja	Código Barras	€ / Ud.
69611	20 x 20 Ø	10	8435195823011	4,80
69612	25 x 25 Ø	10	8435195823028	7,08
69613	32 x 32 Ø	5	8435195823035	9,51
69614	35 x 35 Ø	5	8435195823042	18,55
69615	40 x 40 Ø	2	8435195823059	25,45
69616	45 x 45 Ø	2	8435195823066	41,38
69617	50 x 50 Ø	2	8435195823073	28,75
69618	60 x 60 Ø	2	8435195823080	46,40
69619	70 x 70 Ø	1	8435195823097	75,60

RACOR RÁPIDO MACHO - MANGUERA TIPO "BARCELONA"



Código	Medida	Caja	Código Barras	€ / Ud.
69601	1/2" x 20 Ø	10	8435195822953	4,38
69602	3/4" x 25 Ø	10	8435195822960	9,82
69603	1" x 30 Ø	5	8435195822977	14,24
69604	1 1/4" x 35 Ø	5	8435195822984	23,36
69605	1 1/2" x 45 Ø	2	8435195822991	37,49
69606	2" x 60 Ø	2	8435195823004	45,11

JUNTA CAUCHO RACOR TIPO "BARCELONA"



Código	Medida	Caja	Código Barras	€ / Ud.
69631	20 mm.	25	8435195825053	0,47
69632	25 mm.	25	8435195825060	0,65
69633	30 mm.	25	8435195825077	0,43
69634	35 mm.	10	8435195825084	0,59
69635	40 mm.	10	8435195825091	0,66
69636	45 mm.	10	8435195825107	1,09
69637	50 mm.	5	8435195825114	0,78
69638	60 mm.	5	8435195825121	1,28
69639	70 mm.	5	8435195825138	1,28

RACORERÍA DE LATÓN PARA RIEGO



TE MACHO



Código	Medida	Caja	Código Barras	€ / Ud.
990100	3/8" x 10 mm.	25	8435195816990	3,08

TE HEMBRA



Código	Medida	Caja	Código Barras	€ / Ud.
990101	1/4" x 10 mm.	10	8435195817003	3,98

TE LISA

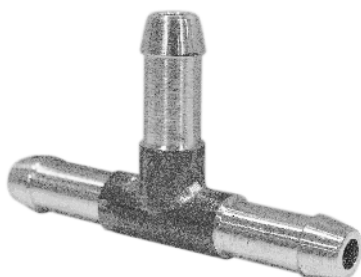

Código	Medida	Caja	Código Barras	€ / Ud.
990102	10 mm. Ø	25	8435195817010	3,30

BOQUILLA MACHO



Código	Medida	Caja	Código Barras	€ / Ud.
990103	1/4"	50	8435195817027	0,95
990104	3/8"	50	8435195817034	1,79
990105	1/2"	50	8435195817041	2,29

BOQUILLA LISA



Código	Medida	Caja	Código Barras	€ / Ud.
990106	8 mm. Ø	50	8435195817058	1,45
990107	10 mm. Ø	50	8435195817065	1,49

BOQUILLA RACOR LOCO



Código	Medida	Caja	Código Barras	€ / Ud.
990108	8 mm. Ø	50	8435195817072	1,74
990109	10 mm. Ø	50	8435195817089	1,75

TUERCA RACOR LOCO



Código	Medida	Caja	Código Barras	€ / Ud.
990110	1/2"	50	8435195817096	0,56



NIPPELS GALVANIZADOS

Nippels galvanizados



200

NIPPELS GALVANIZADOS



ROSCA EN AMBOS EXTREMOS

ROSCA CÓNICA ISO 7/1 (EN 10226-1) DIN 2982 (EN 10241)

NIPPEL GALVANIZADO 1/4"

Código	Medida	Caja	Código Barras	€/ Ud.
80101	1/4" x 40 mm.	10	8435195812787	1,48
80102	1/4" x 60 mm.	10	8435195812794	1,11
80103	1/4" x 80 mm.	10	8435195812800	1,22
80104	1/4" x 100 mm.	10	8435195812817	3,54

NIPPEL GALVANIZADO 3/8"

Código	Medida	Caja	Código Barras	€/ Ud.
99030	3/8" x 40 mm.	10	8435195812824	1,12
80020	3/8" x 60 mm.	10	8435195812831	1,52
98031	3/8" x 80 mm.	10	8435195812848	1,62
82021	3/8" x 100 mm.	10	8435195812855	1,66
98025	3/8" x 120 mm.	10	8435195812862	1,76
82022	3/8" x 160 mm.	10	8435195812879	3,99
82024	3/8" x 200 mm.	10	8435195812886	4,11
82029	3/8" x 300 mm.	10	8435195812893	3,96
98026	3/8" x 500 mm.	10	8435195812909	7,41

NIPPEL GALVANIZADO 1/2"

Código	Medida	Caja	Código Barras	€/ Ud.
80001	1/2" x 40 mm.	10	8435195812916	1,06
80002	1/2" x 60 mm.	10	8435195812923	1,28
80003	1/2" x 80 mm.	10	8435195812930	1,48
80004	1/2" x 100 mm.	10	8435195812947	1,48
80005	1/2" x 120 mm.	10	8435195812954	1,81
80006	1/2" x 140 mm.	10	8435195812961	1,81
80007	1/2" x 160 mm.	10	8435195812978	2,14
80008	1/2" x 180 mm.	10	8435195812985	2,39
80009	1/2" x 200 mm.	10	8435195812992	2,39
80010	1/2" x 250 mm.	10	8435195813005	3,38
80011	1/2" x 300 mm.	10	8435195813012	3,71
80016	1/2" x 400 mm.	10	8435195813029	6,20
80012	1/2" x 500 mm.	10	8435195813036	5,48
80017	1/2" x 600 mm.	10	8435195822175	6,73
80013	1/2" x 1000 mm.	10	8435195822182	10,85

Nota: Se puede fabricar cualquier medida de su interés bajo pedido

NIPPELS GALVANIZADOS

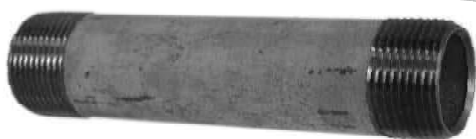

ROSCA EN AMBOS EXTREMOS

ROSCA CÓNICA ISO 7/1 (EN 10226-1) DIN 2982 (EN 10241)

NIPPEL GALVANIZADO 3/4"

Código	Medida	Caja	Código Barras	€ / Ud.
80501	3/4" x 40 mm.	10	8435195813043	1,46
80502	3/4" x 60 mm.	10	8435195813050	1,48
80503	3/4" x 80 mm.	10	8435195813067	1,92
80504	3/4" x 100 mm.	10	8435195813074	2,14
80505	3/4" x 120 mm.	10	8435195813081	2,48
80506	3/4" x 140 mm.	10	8435195813098	2,58
80507	3/4" x 160 mm.	10	8435195813104	2,82
80508	3/4" x 180 mm.	10	8435195813111	2,64
80509	3/4" x 200 mm.	10	8435195813128	3,76
80510	3/4" x 250 mm.	10	8435195813135	4,88
80511	3/4" x 300 mm.	10	8435195813142	5,76
80515	3/4" x 400 mm.	10	8435195813159	5,87
80516	3/4" x 500 mm.	10	8435195813166	6,93

NIPPEL GALVANIZADO 1"

Código	Medida	Caja	Código Barras	€ / Ud.
81001	1" x 40 mm.	10	8435195813173	1,58
81002	1" x 60 mm.	10	8435195813180	1,98
81003	1" x 80 mm.	10	8435195813197	2,31
81004	1" x 100 mm.	10	8435195813203	2,87
81005	1" x 120 mm.	10	8435195813210	2,97
81006	1" x 140 mm.	10	8435195813227	3,13
81007	1" x 160 mm.	10	8435195813234	4,03
81008	1" x 180 mm.	10	8435195813241	3,87
81009	1" x 200 mm.	10	8435195813258	5,60
81010	1" x 250 mm.	10	8435195813265	6,30
81011	1" x 300 mm.	10	8435195813272	8,69
81014	1" x 400 mm.	10	8435195813289	8,95
81013	1" x 500 mm.	10	8435195813296	12,69

NIPPEL GALVANIZADO 1 1/4"

Código	Medida	Caja	Código Barras	€ / Ud.
81501	1 1/4" x 60 mm.	10	8435195813302	2,56
81502	1 1/4" x 80 mm.	10	8435195813319	2,72
81503	1 1/4" x 100 mm.	10	8435195813326	2,14
81504	1 1/4" x 120 mm.	10	8435195813333	4,96
81505	1 1/4" x 140 mm.	10	8435195813340	3,88
81506	1 1/4" x 160 mm.	10	8435195813357	4,45
81507	1 1/4" x 180 mm.	10	8435195813364	4,99
81508	1 1/4" x 200 mm.	10	8435195813371	6,37
81509	1 1/4" x 250 mm.	10	8435195813388	6,68
81510	1 1/4" x 300 mm.	10	8435195813395	9,33
81514	1 1/4" x 400 mm.	10	8435195813401	11,96
81512	1 1/4" x 500 mm.	10	8435195813418	14,67

Nota: Se puede fabricar cualquier medida de su interés bajo pedido

NIPPELS GALVANIZADOS

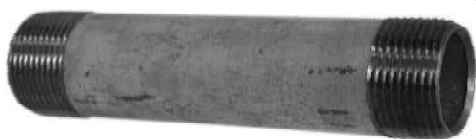

ROSCA EN AMBOS EXTREMOS

ROSCA CÓNICA ISO 7/1 (EN 10226-1) DIN 2982 (EN 10241)

NIPPEL GALVANIZADO 1 1/2"

Código	Medida	Caja	Código Barras	€ / Ud.
82001	1 1/2" x 60 mm.	10	8435195813425	2,72
82002	1 1/2" x 80 mm.	10	8435195813432	3,21
82003	1 1/2" x 100 mm.	10	8435195813449	4,64
82004	1 1/2" x 120 mm.	10	8435195813456	4,29
82005	1 1/2" x 140 mm.	10	8435195813463	4,99
82006	1 1/2" x 160 mm.	10	8435195813470	6,64
82007	1 1/2" x 180 mm.	10	8435195813487	6,35
82008	1 1/2" x 200 mm.	10	8435195813494	8,92
82009	1 1/2" x 250 mm.	10	8435195813500	11,47
82010	1 1/2" x 300 mm.	10	8435195813517	9,65
82013	1 1/2" x 400 mm.	10	8435195813524	11,95
82012	1 1/2" x 500 mm.	10	8435195813531	18,90

NIPPEL GALVANIZADO 2"

Código	Medida	Caja	Código Barras	€ / Ud.
82501	2" x 60 mm.	10	8435195813548	3,86
82502	2" x 80 mm.	10	8435195813555	3,06
82503	2" x 100 mm.	10	8435195813562	4,38
82504	2" x 120 mm.	10	8435195813579	5,61
82505	2" x 140 mm.	10	8435195813586	5,61
82506	2" x 160 mm.	10	8435195813609	6,33
82507	2" x 180 mm.	10	8435195813616	7,59
82508	2" x 200 mm.	10	8435195813623	11,76
82509	2" x 250 mm.	10	8435195813630	9,97
82510	2" x 300 mm.	10	8435195813647	11,57
82513	2" x 400 mm.	10	8435195813654	16,79
82511	2" x 500 mm.	10	8435195813661	19,49

NIPPEL GALVANIZADO 2 1/2"

Código	Medida	Caja	Código Barras	€ / Ud.
82520	2 1/2" x 100 mm.	10	8435195813678	10,59
82521	2 1/2" x 120 mm.	10	8435195813685	7,58
82522	2 1/2" x 160 mm.	10	8435195813692	13,92
82523	2 1/2" x 200 mm.	10	8435195813708	14,55
82524	2 1/2" x 300 mm.	10	8435195813715	16,65
82525	2 1/2" x 500 mm.	10	8435195813722	25,89

NIPPEL GALVANIZADO 3"

Código	Medida	Caja	Código Barras	€ / Ud.
82530	3" x 100 mm.	10	8435195813739	12,92
82531	3" x 120 mm.	10	8435195813746	16,74
82532	3" x 160 mm.	10	8435195813753	13,11
82533	3" x 200 mm.	10	8435195813760	15,84
82534	3" x 300 mm.	10	8435195813777	26,25
82535	3" x 500 mm.	10	8435195813784	52,22

Nota: Se puede fabricar cualquier medida de su interés bajo pedido



VÁLVULAS DE FUNDICIÓN

Racores Unión		204
Abrazaderas de reparación		205
Conexiones manguera		206
Manguitos antivibratorios		206

VÁLVULAS DE FUNDICIÓN

Hierro galvanizado



RACOR UNIÓN MACHO A TUBO fundición maleable

Código	Medida	Caja	Código Barras	€ / Ud.
82901	M 1/2" x 21,3 mm.	5	8435195827576	14,69
82902	M 3/4" x 26,9 mm.	5	8435195827583	18,93
82903	M 1" x 33,7 mm.	5	8435195827590	19,90
82904	M 1 1/4" x 42,4 mm.	1	8435195833867	21,58
82905	M 1 1/2" x 48,3 mm.	1	8435195833874	28,26
82906	M 2" x 60,3 mm.	1	8435195833881	49,99
82907	M 2 1/2" x 76,1 mm.	1	8435195843859	91,87



RACOR UNIÓN HEMBRA A TUBO fundición maleable

Código	Medida	Caja	Código Barras	€ / Ud.
82915	H 1/2" x 21,3 mm.	5	8435195827606	15,84
82916	H 3/4" x 26,9 mm.	5	8435195827613	17,36
82917	H 1" x 33,7 mm.	5	8435195827620	19,97
82918	H 1 1/4" x 42,4 mm.	1	8435195833898	29,98
82919	H 1 1/2" x 48,3 mm.	1	8435195833904	31,59
82920	H 2" x 60,3 mm.	1	8435195833911	54,72



RACOR UNIÓN TUBO A TUBO fundición maleable

Código	Medida	Caja	Código Barras	€ / Ud.
82925	3/8" x 17,2 mm.	5	8435195843873	18,83
82926	1/2" x 21,3 mm.	5	8435195827637	20,94
82927	3/4" x 26,9 mm.	5	8435195827644	24,11
82928	1" x 33,7 mm.	5	8435195827651	22,11
82929	1 1/4" x 42,4 mm.	1	8435195833928	29,45
82930	1 1/2" x 48,3 mm.	1	8435195833935	38,47
82931	2" x 60,3 mm.	1	8435195833942	59,90



VÁLVULAS DE FUNDICIÓN

Hierro galvanizado



ABRAZADERA REPARACIÓN CORTA fundición maleable



Código	Medida	Caja	Código Barras	€ / Ud.
82971	1/2"	5	8435195827668	9,28
82972	3/4"	5	8435195827675	9,95
82973	1"	5	8435195827682	13,28
82974	1 1/4"	5	8435195827699	16,80
82975	1 1/2"	5	8435195827705	20,38
82976	2"	5	8435195827712	26,91
82978	3"	5	8435195843880	68,85

- Abrazaderas de fundición maleable para tubos de PE.
- Impermeabilización y reparación de fisuras y poros en tuberías de PE, PVC y otras.

ABRAZADERA REPARACIÓN LARGA fundición maleable



Código	Medida	Caja	Código Barras	€ / Ud.
82981	1/2"	5	8435195843897	20,05
82982	3/4"	5	8435195843903	17,36
82983	1"	5	8435195843910	27,70

- Abrazaderas de fundición maleable para tubos de PE.
- Impermeabilización y reparación de fisuras y poros en tuberías de PE, PVC y otras.

ABRAZADERA REPARACIÓN TAPAPOROS COBRE



Código	Medida	Caja	Código Barras	€ / Ud.
83124	15 mm.	5	8435195827729	14,84
83126	18 mm.	5	8435195827736	16,28
83127	22 mm.	5	8435195827743	16,39
83128	28 mm.	5	8435195827750	24,25

- Abrazaderas de unión para tubo de cobre.
- Tapaporos y derivaciones en latón.

ABRAZADERA REPARACIÓN TAPAPOROS CON TOMA COBRE



Código	Medida	Caja	Código Barras	€ / Ud.
83141	1/2" x 18 mm.	5	8435195844436	17,93
83142	1/2" x 22 mm.	5	8435195844443	20,26
83143	3/4" x 28 mm.	5	8435195844450	29,93

- Abrazaderas de unión para tubo de cobre.
- Tapaporos y derivaciones en latón.

VÁLVULAS DE FUNDICIÓN

Hierro galvanizado



CONEXIÓN MANGUERA



Código	Medida	Caja	Código Barras	€ / Ud.
82801	3/8" x 100 mm.	10	8435195822755	1,64
82802	1/2" x 100 mm.	10	8435195822762	1,89
82803	3/4" x 100 mm.	10	8435195822779	2,31
82804	1" x 100 mm.	10	8435195822786	3,44
82805	1 1/4" x 100 mm.	5	8435195822793	4,27
82806	1 1/2" x 100 mm.	5	8435195822809	5,32
82807	2" x 100 mm.	2	8435195822816	7,20
82808	2 1/2" x 100 mm.	1	8435195822823	11,30
82809	3" x 100 mm.	1	8435195822830	18,63

MANGUITO ANTIVIBRATORIO DOBLE ONDA



Código	Medida	Caja	Código Barras	€ / Ud.
82562	3/4"	1	8435195825213	22,87
82563	1"	1	8435195825220	24,12
82564	1 1/4"	1	8435195825237	36,43
82565	1 1/2"	1	8435195825244	42,50
82566	2"	1	8435195825251	53,78
82567	2 1/2"	1	8435195827521	77,35
82568	3"	1	8435195827538	98,96

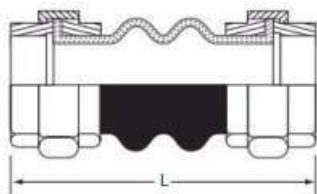



CALEFACCIÓN

Purgadores automáticos		208
Purgadores manuales		209
Válvulas de seguridad y retención		209
Válvulas y detentores manuales para radiador		210
Válvulas termostaticables para radiador		212
Colectores		213
Complementos colectores		214
Termostatos y cronotermostatos		215
Tuercas		216
Florones y tapones		217
Soportes de radiador y casquillos		218

CALEFACCIÓN

Purgadores automáticos de aire



PURGADOR AUTOMÁTICO DE AIRE salida superior



Código	Medida	Caja	Código Barras	€ / Ud.
90040	3/8"	20	8435195816808	8,95
90041	1/2"	20	8435195816815	9,37

PURGADOR AUTOMÁTICO DE AIRE salida lateral



Código	Medida	Caja	Código Barras	€ / Ud.
90045	3/8"	10	8435195816822	8,64
90046	1/2"	10	8435195816839	8,41

PURGADOR AUTOMÁTICO DE AIRE toma lateral



Código	Medida	Caja	Código Barras	€ / Ud.
90049	3/8"	10	8435195816846	7,81
90050	1/2"	10	8435195816853	7,96

VÁLVULA RETENCIÓN PARA PURGADOR AUTOMÁTICO



Código	Medida	Caja	Código Barras	€ / Ud.
90053	3/8"	20	8435195816860	1,30
90054	1/2"	20	8435195816877	1,60

CARACTERÍSTICAS TÉCNICAS:

- Cuerpo y tapa de latón UNI EN 12165
- Flotador PP
- Vástago de obturador de latón UNI EN 12165
- Muelle de acero inoxidable
- EPDM
- Uso para fluidos de agua y solución de glicol.
- Máximo porcentaje de glicol: 30%.
- Presión máxima de trabajo: 10 bar.
- Presión máxima de descarga: de 2,5 a 4 bar.
- Temperatura máxima de trabajo: 110°C - 120°C.

PURGADOR MANUAL DE AIRE PARA RADIADOR



Código	Medida	Caja	Código Barras	€ / Ud.
90057	1/8"	20	8435195816884	1,33
90058	1/4"	20	8435195816891	0,88
90059	3/8"	20	8435195816907	1,37
90060	1/2"	20	8435195816914	2,65

PURGADOR AUTOMÁTICO DE AIRE PARA RADIADOR



	Código	Medida	Caja	Código Barras	€ / Ud.
Izquierda	90070	1"	10	8435195816921	8,69
	90071	1 1/4"	10	8435195816938	8,69
Derecha	90072	1"	10	8435195816945	8,69
	90073	1 1/4"	10	8435195816952	8,69

VÁLVULA DE SEGURIDAD SIN SISTEMA DE RETENCIÓN



Código	Medida	Caja	Código Barras	€ / Ud.
90074	1/2"	50	8435195845174	3,73

VÁLVULA DE SEGURIDAD Y RETENCIÓN PARA TERMO



	Código	Medida	Caja	Código Barras	€ / Ud.
Sin palanca	90075	3/8"	50	8435195816969	3,10
	99506	1/2"	50	8435195815344	3,75
	90077	3/4"	50	8435195816983	7,96



	Código	Medida	Caja	Código Barras	€ / Ud.
Con palanca	90076	1/2" 8 Bares	50	8435195816976	4,85
	90079	1/2" 10 Bares	50	8435195827545	4,98
	90078	3/4" 8 Bares	50	8435195822748	9,77
	90098	3/4" 10 Bares	50	8435195845181	9,92

- Cuerpo de latón UNI EN 12165 cromado.
- Muelle: acero inoxidable 316,
- Rosca M/H.

DISPOSITIVO ANTIGOTEO PARA VÁLVULA DE SEGURIDAD



Código	Medida	Caja	Código Barras	€ / Ud.
90065	1/2"	10	8435195828177	5,96

CALEFACCIÓN

Válvulas y detentores manuales para radiador



VÁLVULA ESCUADRA M-M

	Código	Medida	Caja	Código Barras	€ / Ud.
Sin juntas	90080	3/8"	25	8435195823967	10,86
	90081	1/2"	25	8435195823974	9,55

	Código	Medida	Caja	Código Barras	€ / Ud.
Con juntas	90082	3/8"	25	8435195823981	11,45
	90083	1/2"	25	8435195823998	10,24



- Regulación manual.
- Cuerpo y tuerca en latón UNI EN 12165 niquelado.
- Obturador y racor en latón UNI EN 12164.
- Junta de estanqueidad obturador en EPDM.
- Volante en ABS blanco.
- Junta de estanqueidad racor en NBR.
- Presión máxima de ejercicio: 10 bar. / Presión diferencial máxima: 6 bar.

DETENTOR VÁLVULA ESCUADRA M-M

	Código	Medida	Caja	Código Barras	€ / Ud.
Sin juntas	90084	3/8"	25	8435195824001	9,75
	90085	1/2"	25	8435195824018	7,52

	Código	Medida	Caja	Código Barras	€ / Ud.
Con juntas	90086	3/8"	25	8435195824025	11,05
	90087	1/2"	25	8435195824032	7,97



- Regulación manual.
- Cuerpo y tuerca en latón UNI EN 12165 niquelado.
- Obturador, racor y anillo en latón UNI EN 12164.
- Junta de estanqueidad obturador en EPDM.
- Junta superior de estanqueidad obturador en EPDM.
- Capucha en ABS blanco.
- Junta de estanqueidad racor en NBR.
- Presión máxima de ejercicio: 10 bar. / Presión diferencial máxima: 6 bar.

CALEFACCIÓN

Válvulas y detentores manuales para radiador



VÁLVULA ESCUADRA M-H

	Código	Medida	Caja	Código Barras	€ / Ud.
Sin juntas	90088	3/8"	25	8435195824049	11,79
	90089	1/2"	25	8435195824056	8,23

	Código	Medida	Caja	Código Barras	€ / Ud.
Con juntas	90090	3/8"	25	8435195824063	9,78
	90093	1/2"	25	8435195824070	11,14



- Regulación manual.
- Cuerpo y tuerca en latón UNI EN 12165 niquelado.
- Obturador y racor en latón UNI EN 12164.
- Junta de estanqueidad obturador en EPDM.
- Volante en ABS blanco.
- Junta de estanqueidad racor en NBR.
- Presión máxima de ejercicio: 10 bar. / Presión diferencial máxima: 6 bar.

DETENTOR VÁLVULA ESCUADRA M-H

	Código	Medida	Caja	Código Barras	€ / Ud.
Sin juntas	90094	3/8"	25	8435195824087	5,69
	90095	1/2"	25	8435195824094	8,69

	Código	Medida	Caja	Código Barras	€ / Ud.
Con juntas	90096	3/8"	25	8435195824100	7,23
	90097	1/2"	25	8435195824117	9,39



- Regulación manual.
- Cuerpo y tuerca en latón UNI EN 12165 niquelado.
- Obturador, racor y anillo en latón UNI EN 12164.
- Junta de estanqueidad obturador en EPDM.
- Junta superior de estanqueidad obturador en EPDM.
- Capucha en ABS blanco.
- Junta de estanqueidad racor en NBR.
- Presión máxima de ejercicio: 10 bar. / Presión diferencial máxima: 6 bar.

CALEFACCIÓN

Válvulas termostaticables para radiador



VÁLVULA ESCUADRA M-M TERMOSTATIZABLE

	Código	Medida	Caja	Código Barras	€ / Ud.
Sin juntas	90100	3/8"	25	8435195824452	9,25
	90101	1/2"	25	8435195824469	10,88

	Código	Medida	Caja	Código Barras	€ / Ud.
Con juntas	90102	3/8"	25	8435195824476	9,66
	90103	1/2"	25	8435195824483	13,24



- Cuerpo y tuerca en latón UNI EN 12165 niquelado.
- Casquillo en PA6 (30% FV)
- Obturador, casquillo y arandela bloqueo de estanqueidad latón UNI EN 12164.
- Junta de estanqueidad cuerpo obturador en NBR.
- Muelle en acero AISI 302.
- Eje en acero AISI 304.
- Junta de estanqueidad obturador en EPDM.
- Juntas obturador en NBR.
- Volante en ABS blanco.
- Tuerca y racor en latón UNI EN 12165 niquelado.
- Junta de estanqueidad racor en NBR.
- Presión máxima de ejercicio: 10 bar. / Presión diferencial máxima: 6 bar.
- Adaptable a cabezales termostáticos Sensor o cabezales termoelectricos.

VÁLVULA ESCUADRA M-H TERMOSTATIZABLE

	Código	Medida	Caja	Código Barras	€ / Ud.
Sin juntas	90108	3/8"	25	8435195824490	9,57
	90109	1/2"	25	8435195824506	10,62

	Código	Medida	Caja	Código Barras	€ / Ud.
Con juntas	90110	3/8"	25	8435195824513	9,98
	90111	1/2"	25	8435195824520	11,20



- Cuerpo y tuerca en latón UNI EN 12165 niquelado.
- Casquillo en PA6 (30% FV)
- Obturador, casquillo y arandela bloqueo de estanqueidad latón UNI EN 12164.
- Junta de estanqueidad cuerpo obturador en NBR.
- Muelle en acero AISI 302.
- Eje en acero AISI 304.
- Junta de estanqueidad obturador en EPDM.
- Juntas obturador en NBR.
- Volante en ABS blanco.
- Tuerca y racor en latón UNI EN 12165 niquelado.
- Junta de estanqueidad racor en NBR.
- Presión máxima de ejercicio: 10 bar. / Presión diferencial máxima: 6 bar.
- Adaptable a cabezales termostáticos Sensor o cabezales termoelectricos.

CALEFACCIÓN

Colectores



COLECTOR CON VÁLVULA M-H



Código	Medida	Caja	Código Barras	€ / Ud.
90001	3/4" 2 Vías	5	8435195823769	21,93
90003	3/4" 3 Vías	5	8435195823776	30,99
90005	3/4" 4 Vías	5	8435195823783	56,28
Código	Medida	Caja	Código Barras	€ / Ud.
90002	1" 2 Vías	5	8435195823790	20,60
90004	1" 3 Vías	5	8435195823806	29,98
90006	1" 4 Vías	5	8435195823813	38,90

- Cuerpo en latón UNI EN 12165 niquelado.
- Conexiones roscadas 24 x 19
- Volante en ABS blanco.
- Juntas NBR.
- Presión máxima de ejercicio: 10 bar.
- Temperatura máxima de ejercicio +110°C.

COLECTOR M-H



Código	Medida	Caja	Código Barras	€ / Ud.
90011	3/4" 2 Vías	5	8435195823820	10,75
90013	3/4" 3 Vías	5	8435195823837	17,86
90015	3/4" 4 Vías	5	8435195823844	18,26
Código	Medida	Caja	Código Barras	€ / Ud.
90012	1" 2 Vías	5	8435195823851	16,90
90014	1" 3 Vías	5	8435195823868	22,82
90016	1" 4 Vías	5	8435195823875	28,89

- Cuerpo en latón UNI EN 12165 niquelado.
- Derivaciones roscas 24 x 19 con paso de Ø 14 mm.
- Junta entre los elementos NBR 70.
- Presión máxima de ejercicio: 10 bar.
- Temperatura máxima de ejercicio de 0°C a +110°C.

COLECTOR H-H



Código	Medida	Caja	Código Barras	€ / Ud.
90226	1" x 1/2" x 114 2 Vías	5	8435195824889	12,06
90228	1" x 1/2" x 214 4 Vías	5	8435195824896	23,25
90229	1" x 1/2" x 264 5 Vías	5	8435195824902	29,17
90230	1" x 1/2" x 314 6 Vías	5	8435195824919	34,47
90232	1" x 1/2" x 414 8 Vías	5	8435195824926	45,63
90234	1" x 1/2" x 514 10 Vías	5	8435195824933	72,16
90237	1 1/4" x 1/2" x 220 4 Vías	5	8435195824940	30,09
90239	1 1/4" x 1/2" x 320 6 Vías	5	8435195824957	51,52
90242	1 1/4" x 1/2" x 470 9 Vías	5	8435195824964	64,02
90243	1 1/4" x 1/2" x 520 10 Vías	5	8435195824971	69,75
90245	1 1/4" x 1/2" x 620 12 Vías	5	8435195824988	129,71
90252	1 1/2" x 1" x 370 4 Vías	1	8435195833409	239,79
90253	1 1/2" x 1" x 570 6 Vías	1	8435195833416	210,25

CAJA COLECTOR ABS "PLASTIBOX"

Código	Medida	Caja	Código Barras	€ / Ud.
90031	310 x 310 x 90	5	8435195823882	27,95
90032	460 x 310 x 90	5	8435195823899	27,22
90033	610 x 310 x 90	5	8435195823905	33,34



PERFIL PARA CAJA COLECTOR "PLASTIBOX"

Código	Medida	Caja	Código Barras	€ / Ud.
90036	400 mm.	10	8435195823912	15,55



SOPORTE PARA CAJA DE COLECTOR TIPO "CONTROLLER"

Código	Medida	Caja	Código Barras	€ / Ud.
90034	Colector 3/4"	10	8435195823929	1,69
90035	Colector 1"	10	8435195823936	1,69



SOPORTE PARA CAJA DE COLECTOR TIPO "THERMODAY"

Código	Medida	Caja	Código Barras	€ / Ud.
90037	Colector 3/4"	10	8435195823943	1,29
90038	Colector 1"	10	8435195823950	1,29



CALEFACCIÓN



CABEZAL TERMOSTÁTICO CON SENSOR LÍQUIDO



Código	Medida	Caja	Código Barras	€ / Ud.
90120	3/8" x 1/2"	1	8435195824124	15,08

- Presión máxima de ejercicio: 10 Bar.
- Presión máxima diferencial: 1 Bar.
- Temperatura máxima ambiente: 40°C.
- Temperatura máxima agua instalación: 100°C.
- Campo de regulación: 7 - 28 °C.

VÁLVULA MONOTUBO TERMOSTATIZABLE



Código	Medida	Caja	Código Barras	€ / Ud.
90128	1/2" Derecha	1	8435195824155	45,93

CRONOTERMOSTATO ELECTRÓNICO SEMANAL



Código	Medida	Caja	Código Barras	€ / Ud.
90135	130 x 80 x 26	1	8435195824179	54,40

- Frontal transparente.

CRONOTERMOSTATO ELECTRÓNICO SEMANAL



Código	Medida	Caja	Código Barras	€ / Ud.
90136	130 x 80 x 26	1	8435195824186	44,80

- Frontal negro.

TERMOSTATO AMBIENTE MECÁNICO



Código	Medida	Caja	Código Barras	€ / Ud.
90137	90 x 90 x 40	1	8435195824193	19,50

TUERCA MONOBLOC PARA TUBO DE COBRE



Código	Medida	Caja	Código Barras	€ / Ud.
90140	12 Ø	50	8435195824209	2,81
90141	14 Ø	50	8435195824216	1,85
90142	15 Ø	50	8435195824223	2,69
90143	16 Ø	50	8435195824230	2,44

- Presión máxima: 10 Bar.
- Temperatura máxima: 100°C.
- Niquelada.

TUERCA MONOBLOC CON BICONO PARA TUBO DE COBRE



Código	Medida	Caja	Código Barras	€ / Ud.
90146	18 Ø	40	8435195824247	2,27

- Presión máxima: 10 Bar.
- Niquelada.

TUERCA MONOBLOC PARA TUBO MULTICAPA



Código	Medida	Caja	Código Barras	€ / Ud.
90150	16 x 2	50	8435195824254	3,99
90151	16 x 2,25	50	8435195824261	3,54
90152	20 x 2	50	8435195824278	3,31
90153	20 x 2,50	40	8435195824285	3,10
90154	25 x 2,50	20	8435195824292	5,54

- Niquelada.
- Premontada.

TUERCA MONOBLOC PARA PEX - POLIPROPILENO - POLIBUTILENO



Código	Medida	Caja	Código Barras	€ / Ud.
90161	16 x 2	40	8435195824308	4,56
90162	18 x 2	40	8435195824315	3,20
90163	20 x 2	40	8435195824322	3,20

- Niquelada.
- Premontada.

CONJUNTO TUERCA Y MANGUITO RACOR COLECTOR



Código	Medida	Caja	Código Barras	€ / Ud.
90170	1/2" sin junta	10	8435195827552	3,57
90171	1/2" con junta	10	8435195827569	4,39

CALEFACCIÓN



FLORON UNIVERSAL

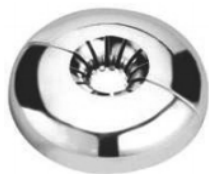

	Código	Medida	Caja	Código Barras	€ / Ud.
Blanco	90260	8 a 22 mm Ø	10	8435195833423	0,29
Cromo	90261	12 a 18 mm Ø	10	8435195833430	1,08

TAPÓN RADIADOR ZINCADO Ø 42



	Código	Medida	Caja	Código Barras	€ / Ud.
Izquierda	90269	1" Ciego	10	8435195833492	1,08
	90271	1" x 1/8"	10	8435195833515	1,08
	90273	1" x 1/4"	10	8435195833539	0,59
	90275	1" x 3/8"	10	8435195833553	0,59
	90277	1" x 1/2"	10	8435195833577	1,08
Derecha	90268	1" ciego	10	8435195833485	1,08
	90270	1" x 1/8"	10	8435195833508	0,65
	90272	1" x 1/4"	10	8435195833522	0,59
	90274	1" x 3/8"	10	8435195833546	0,59
	90276	1" x 1/2"	10	8435195833560	1,08

TAPÓN RADIADOR BLANCO Ø 42



	Código	Medida	Caja	Código Barras	€ / Ud.
Izquierda	90279	1" Ciego	10	8435195833591	0,99
	90281	1" x 1/8"	10	8435195833614	0,99
	90259	1" x 1/4"	10	8435195833638	0,99
	90283	1" x 3/8"	10	8435195833706	0,99
	90285	1" x 1/2"	10	8435195833669	1,12
Derecha	90278	1" ciego	10	8435195833584	1,08
	90280	1" x 1/8"	10	8435195833607	0,99
	90258	1" x 1/4"	10	8435195833621	0,99
	90282	1" x 3/8"	10	8435195833645	0,99
	90284	1" x 1/2"	10	8435195833652	0,99

LLAVE UNIVERSAL DE NYLON PARA TAPONES



Código	Medida	Caja	Código Barras	€ / Ud.
90266	1/2", 1" y 1 1/4"	1	8435195833447	7,35

KIT UNIVERSAL TAPONES Ø 42



Código	Descripción	Caja	Código Barras	€ / Ud.
90290	Zincado	1	8435195833676	7,69
90291	Blanco	1	8435195833683	8,85

- Contiene: 2 Reduc. 1" x 1/2" derecha, 2 Reduc. 1" x 1/2" izquierda, 4 juntas, 1 tapón 1/2" y 1 purgador 1/2".

CALEFACCIÓN



SOPORTE RADIADOR REGULABLE



Código	Descripción	Caja	Código Barras	€ / Ud.
90301	Metal	10	8435195833454	1,56

SOPORTE RADIADOR 1 PATILLA METÁLICO

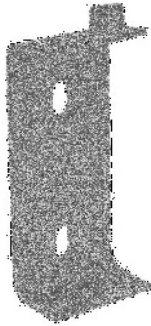

Código	Descripción	Caja	Código Barras	€ / Ud.
90302	Metal	10	8435195833461	0,47

SOPORTE RADIADOR 1 PATILLA NYLON



Código	Descripción	Caja	Código Barras	€ / Ud.
90306	Nylon	10	8435195833478	1,05

CASQUILLO RADIADOR



Código	Medida	Caja	Código Barras	€ / Ud.
90296	1" x 30 mm	10	8435195833690	0,44



JUNTAS Y ARANDELAS

Juntas tóricas		220
Juntas planas		221
Arandelas de goma		222
Juntas de fibra		222
Juntas klinger		223
Juntas de teflón		223

JUNTAS Y ARANDELAS

Juntas tóricas



ESTUCHE PARA JUNTAS



Código	Descripción	Caja	Código Barras	€ / Ud.
99520	Con separadores	1	8435195812732	10,75

JUNTAS TÓRICAS NBR-70 en pulgadas

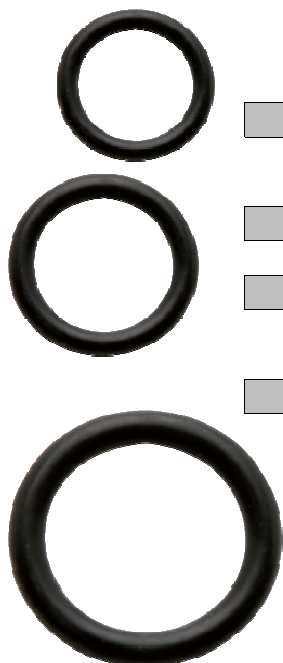

Código	Descripción	Caja	Código Barras	€ / Ud.
83020	AN 00 2,20 x 1,60	50	8435195813975	0,028
83001	AN 1 2,90 x 1,78	100	8435195813791	0,025
83002	AN 2 3,68 x 1,78	100	8435195813807	0,025
83003	AN 3 4,47 x 1,78	100	8435195813814	0,025
83004	AN 4 5,28 x 1,78	100	8435195813821	0,025
1/4"	83005 AN 5 6,07 x 1,78	100	8435195813838	0,025
	83006 AN 6 7,65 x 1,78	100	8435195813845	0,025
	83007 AN 7 9,25 x 1,78	100	8435195813852	0,025
3/8"	83008 AN 8 9,19 x 2,62	100	8435195813869	0,031
	83009 AN 9 10,77 x 2,62	100	8435195813876	0,031
1/2"	83010 AN 10 12,37 x 2,62	100	8435195813883	0,031
	83011 AN 11 13,94 x 2,62	100	8435195813890	0,041
	83012 AN 12 15,54 x 2,62	100	8435195813906	0,041
3/4"	83013 AN 13 17,12 x 2,62	50	8435195813913	0,041
	83014 AN 14 18,64 x 2,62	50	8435195813920	0,041
	83015 AN 15 18,64 x 3,53	50	8435195813937	0,052
	83016 AN 16 20,22 x 3,53	50	8435195813944	0,059
	83017 AN 17 21,82 x 3,53	50	8435195813951	0,063
	83018 AN 18 23,39 x 3,53	50	8435195813968	0,071

ESTUCHE JUNTAS TÓRICAS NBR-70 en pulgadas



Código	Descripción	Caja	Código Barras	€ / Ud.
83019	18 medidas	650	8435195813982	29,60

• Contiene:

50 uds. de la Ref. 83001 a la 83007.

25 uds. de la Ref. 83008 a la 83018.

ESTUCHE JUNTAS TÓRICAS NBR-70 métrica

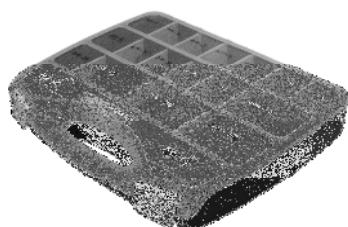

Código	Descripción	Caja	Código Barras	€ / Ud.
83065	19 medidas	650	8435195818116	41,17

• Contiene:

50 uds. de M 3 x 2 a M 10 x 2.

25 uds. de M 10 x 2,5 a M 25 x 3.

JUNTAS Y ARANDELAS

Juntas planas



JUNTAS PLANAS ANCHAS DE CAUCHO



Código	Medida	Caja	Código Barras	€ / Ud.
83502	3/8" 8 x 14,5 x 2	100	8435195813999	0,030
83503	1/2" 10 x 18,5 x 2	100	8435195814002	0,030
83520	1/2" 10 x 18,5 x 4	100	8435195827767	0,058
83504	3/4" 12 x 23,5 x 2	100	8435195814019	0,042
83509	3/4" 13 x 23,5 x 3	100	8435195822687	0,046
83505	1" 20 x 30 x 2,5	100	8435195814026	0,070
83506	1 1/4" 29 x 37 x 2,5	100	8435195814033	0,110
83507	1 1/2" 30 x 44,5 x 2,5	100	8435195814040	0,130
83508	2" 46 x 56 x 2,5	100	8435195814057	0,160
99322	2 1/2" 57 x 69,5 x 3,5	10	8435195824667	0,300
99334	3" 70 x 82,5 x 3,5	10	8435195824674	0,430

JUNTAS PLANAS NORMALES DE CAUCHO



Código	Descripción	Caja	Código Barras	€ / Ud.
84002	3/8" 10 x 14,5 x 2	100	8435195814064	0,035
84003	1/2" 14 x 18,5 x 2	100	8435195814071	0,043
84004	3/4" 18 x 23,5 x 2	100	8435195814088	0,045
84005	1" 24 x 30 x 2,5	100	8435195814095	0,057
84006	1 1/4" 30 x 35 x 2,5	100	8435195814101	0,088
84007	1 1/2" 37 x 44,5 x 2,5	100	8435195814118	0,099
84008	2" 50 x 56 x 2,5	100	8435195814125	0,150

ESTUCHE JUNTAS PLANAS ANCHAS DE CAUCHO

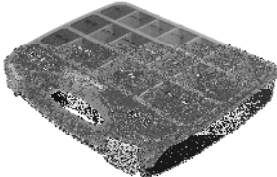

Código	Descripción	Caja	Código Barras	€ / Ud.
84009	7 medidas	425	8435195814132	28,07

• Contiene: 100 uds. 3/8", 1/2" y 3/4" - 50 uds. 1" - 25 uds. 1 1/4", 1 1/2" y 2".

ESTUCHE JUNTAS PLANAS NORMALES DE CAUCHO

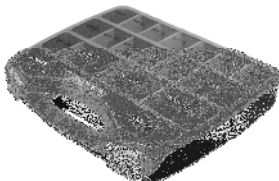

Código	Descripción	Caja	Código Barras	€ / Ud.
84011	7 medidas	425	8435195821390	28,07

• Contiene: 100 uds. 3/8", 1/2" y 3/4" - 50 uds. 1" - 25 uds. 1 1/4", 1 1/2" y 2".

ESTUCHE JUNTAS PLANAS MIXTAS DE CAUCHO

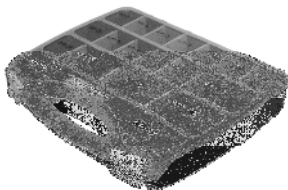

Código	Descripción	Caja	Código Barras	€ / Ud.
84010	7 medidas	425	8435195814149	39,70

• Contiene ANCHAS: 100 uds. 3/8", 1/2" y 3/4" - 50 uds. 1"
NORMALES: 100 uds. 3/8", 1/2" y 3/4" - 50 uds. 1"

JUNTAS CON FILTRO INOXIDABLE



Código	Medida	Caja	Código Barras	€ / Ud.
83515	1/2"	25	8435195827774	0,49
83516	3/4"	100	8435195827781	0,54

JUNTAS Y ARANDELAS

Arandelas de goma y juntas de fibra



ARANDELAS DE GOMA BLANCA CÓNICAS

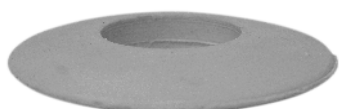

Código	Medida	Caja	Código Barras	€ / Ud.
84012	3/8" x 50	100	8435195814156	0,370
84013	1/2" x 51	100	8435195814163	0,440
84014	3/4" x 57	100	8435195814170	0,510
84015	1" x 61	100	8435195814187	0,530
84016	1 1/4" x 61	100	8435195814194	0,540
84017	1 1/2" x 66	50	8435195814200	0,880
84018	2" x 83	50	8435195814958	0,700

ARANDELAS DE GOMA BLANCA SEMICÓNICAS

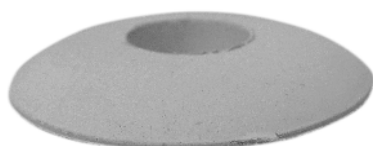

Código	Medida	Caja	Código Barras	€ / Ud.
84022	3/8" x 50	100	8435195814217	0,780
84023	1/2" x 51	100	8435195814224	0,460
84024	3/4" x 57	100	8435195814231	0,510
84025	1" x 61	100	8435195814248	0,520
84026	1 1/4" x 61	100	8435195814255	0,540
84027	1 1/2" x 66	50	8435195814262	0,770
84028	2" x 83	50	8435195820256	0,980

ARANDELAS DE GOMA BLANCA PLANAS

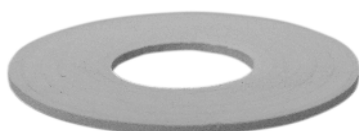

Código	Medida	Caja	Código Barras	€ / Ud.
84032	3/8" 16 x 32 x 2	100	8435195814279	0,075
84033	1/2" 20 x 45 x 2	100	8435195814286	0,120
84034	3/4" 25 x 60 x 2	100	8435195814293	0,170
84035	1" 35 x 70 x 2	100	8435195814309	0,210
84036	1 1/4" 40 x 70 x 2	100	8435195814316	0,210
84037	1 1/2" 45 x 70 x 2	100	8435195814323	0,190
84038	2" 50 x 80 x 2	100	8435195814330	0,200

JUNTAS PLANAS DE FIBRA



Código	Medida	Caja	Código Barras	€ / Ud.
84501	16 x 1,5	100	8435195814347	0,100
84502	17 x 1,5	100	8435195814354	0,100
84503	18 x 1,5	100	8435195814361	0,100
84504	19 x 1,5	100	8435195814378	0,100
84505	20 x 1,5	100	8435195814385	0,100
84506	21 x 1,5	100	8435195814392	0,100
84507	22 x 1,5	100	8435195814408	0,100

ESTUCHE JUNTAS PLANAS DE FIBRA

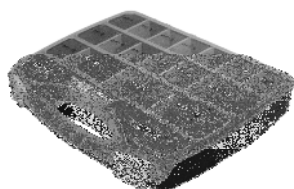

Código	Descripción	Caja	Código Barras	€ / Ud.
84508	7 medidas	700	8435195814415	69,70

• Contiene 100 uds. por medida.

JUNTAS Y ARANDELAS

Juntas klinger y juntas de teflón



JUNTAS PLANAS KLINGER SIN AMIANTO



Código	Medida	Caja	Código Barras	€ / Ud.
84515	1/8" racor	100	8435195814422	0,070
84516	1/4" racor	100	8435195814439	0,078
84517	3/8" racor	100	8435195814446	0,070
84518	1/2" x 10 flexo	100	8435195814453	0,092
84519	1/2" x 12 racor	100	8435195820263	0,084
84520	1/2" x 14 racor	100	8435195814460	0,093
84521	3/4" x 13 batería	100	8435195814477	0,110
84522	3/4" x 17 batería	100	8435195814484	0,110
84523	3/4" x 18 racor	100	8435195814491	0,110
84524	1" racor	100	8435195814507	0,130
84525	1" ancha	100	8435195814514	0,130
84528	1" radiador	100	8435195814552	0,130
84514	1 1/4" racor	100	8435195814521	0,180
84526	1 1/4" ancha	100	8435195814538	0,180
84527	1 1/2" ancha	100	8435195814545	0,200
84532	2" racor	25	8435195833713	0,320
84555	2" ancha	100	8435195833720	0,490

ESTUCHE JUNTAS PLANAS KLINGER SIN AMIANTO

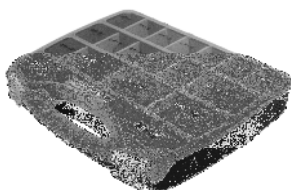

Código	Descripción	Caja	Código Barras	€ / Ud.
84529	14 medidas	950	8435195814569	77,05

1/8" (100)	1/2" x 10 (100)	3/4" x 13 1" racor (50)	1 1/4" (25)
1/4" (100)	1/2" x 12 (100)	3/4" x 17 1" ancha (50)	1 1/2" (25)
3/8" (100)	1/2" x 14 (100)	3/4" x 18 1" radiador (25)	

JUNTAS PLANAS DE TEFLÓN



Código	Medida	Caja	Código Barras	€ / Ud.
84535	3/8" 14'5 x 7 x 1'5	100	8435195814576	0,074
84536	3/8" 14'5 x 10 x 1'5	100	8435195814583	0,076
84537	1/2" x 10 18'5 x 10 x 1'5	100	8435195814590	0,120
84538	1/2" x 12 18'5 x 12 x 1'5	100	8435195814606	0,140
84539	1/2" x 14 18'5 x 14 x 1'5	100	8435195814613	0,130
84540	3/4" x 13 24 x 13 x 1'5	100	8435195814620	0,180
84541	3/4" x 18 24 x 18 x 1'5	100	8435195814637	0,130
84542	3/4" x 19 24 x 19 x 1'5	100	8435195814644	0,130
84533	7/8" 27 x 21 x 1'5	100	8435195814651	0,170
84543	1" 30 x 24 x 1'5	100	8435195814668	0,170
84544	1 1/4" 39 x 30 x 1'5	100	8435195814675	0,290
84545	1 1/2" 45 x 37 x 1'5	100	8435195814682	0,240
84546	1" 42 x 33 x 1'5	100	8435195814699	0,190
84547	1 1/4" 50 x 41 x 1'5	100	8435195814705	0,230
84549	1" 30 x 20 x 1'5	100	8435195814712	0,230
84550	2" 57 x 49 x 1'5	100	8435195820270	0,470

ESTUCHE JUNTAS PLANAS DE TEFLÓN

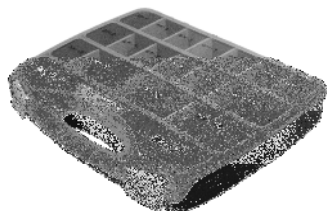

Código	Descripción	Caja	Código Barras	€ / Ud.
84548	13 medidas	825	8435195812190	103,87

3/8" x 7 (100)	1/2" x 14 (100)	1" x 24 (50)
3/8" x 10 (100)	3/4" x 13 (100)	1" x 33 (50)
1/2" x 10 (100)	3/4" x 18 (100)	1 1/4" x 30 (25)
1/2" x 12 (100)	3/4" x 19 (100)	1 1/4" x 41 (25)
		1 1/2" x 37 (25)



MEMBRANAS

Membranas









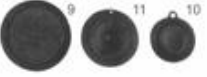

226

MEMBRANAS

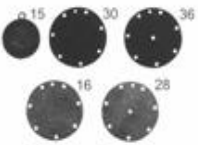

MEMBRANAS PARA CALENTADOR

	Marca	Código	Nº / Descripción	Caja	Código Barras	€/ Ud.
	Cointra Agni Corcho	88041	2 / 5 l. antiguo	25	8435195815658	0,96
		88042	3 / 10 l. moderno	25	8435195815665	1,32
		88043	19 / 10 l. antiguo	25	8435195815672	0,96
		88044	0 / 5 l. Cointra	25	8435195815689	1,32
	Fagor Aspes	88045	4 / 5 l. David	25	8435195815696	0,96
		88046	5 / 5 l. 5 K moderno	25	8435195844900	0,96
		88047	6 / 5l. 10 TE antiguo	25	8435195815719	0,96
		88048	7 / 5l. 10TE 10K moderno	25	8435195815726	0,96
		88049	8 / 10 l. Bules moderno	25	8435195815733	0,96
		88050	33 / 5l. D15 D50 moderno	25	8435195815740	1,32
	Otsein	88051	9 / 5 l. y 10 l. antiguo baja presión	25	8435195815757	0,75
		88052	10 / 5 l. y 10 l. moderno	25	8435195815764	0,75
		88053	11 / 5 l. y 10 l. moderno	25	8435195815771	0,96
	Balay	88054	12 / 5 l. 7 l. 10 l. moderno	25	8435195815788	0,96
	Aitona	88055	37 / Alta y baja presión	25	8435195815795	0,96
	Fuima	88056	38 / Alta y baja presión	25	8435195815801	0,96
	Junkers	88057	13 / 5 l. moderno FD-330	25	8435195815818	1,45
		88059	25 / 5 l. antiguo	25	8435195815832	0,96
		88060	26 / 10 l. antiguo	25	8435195815849	0,96
	Corberó	88061	15 / 5 l. moderno C-51 y C-52	25	8435195815856	0,96
		88062	30 / 5 l. antiguo LM-8 baja presión	25	8435195815863	1,05
		88063	36 / 10 l. moderno LM25/LM-26	25	8435195815870	1,05
		88064	16 / 5 l. LM-8 presión normal	25	8435195815887	1,05
		88065	28 / 10 l. LM25/LM26 presión normal	25	8435195815894	1,05
	Orbegozo	88066	17 / 10 l. moderno	25	8435195815900	0,96
		88067	18 / 5 l. antiguo	25	8435195815917	0,96
	Vaillant	88068	22 / 10 l. moderno	25	8435195815924	0,96
		88069	20 / 5 l. antiguo	25	8435195815931	0,96
	Saunier	88070	21 / 5 l. moderno	25	8435195815948	0,96
	Duval	88071	23 / 10 l. moderno	25	8435195815955	0,96
	Chafoteaux Roca	88072	27 / 5 l. y 10 l. moderno	25	8435195815962	0,96
		88073	34 / Roca - Chafoteaux	25	8435195815979	0,96
		88074	35 / Chafoteaux	25	8435195815986	0,96
		88075	24 / Tropik	25	8435195815993	1,05



SOLETAS Y PORTASOLETAS

Soletas y portasoletas



228

SOLETAS Y PORTASOLETAS



PORTASOLETAS DE ACERO INOXIDABLE

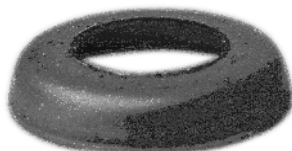

Código	Medida	Caja	Código Barras	€ / Ud.
87001	16/150	100	8435195815283	0,12
87002	17/150	100	8435195815290	0,12
87003	18/150	100	8435195815306	0,12
87004	19/150	100	8435195815313	0,12

PORTASOLETAS DE LATÓN

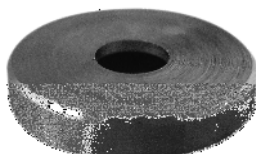

Código	Medida	Caja	Código Barras	€ / Ud.
99166	3/4"	100	8435195815320	0,49

• Sirve para la soleta de 20 x 4 x 4 - Cód. 88008.

SOLETAS DE CAUCHO



	Código	Medida	Caja	Código Barras	€ / Ud.
Nº 8	88001	12 x 4 x 4	100	8435195815351	0,037
	88002	13 x 4 x 4	100	8435195815368	0,037
Nº 11	88003	14 x 4 x 4	100	8435195815375	0,037
	88004	15 x 4 x 4	100	8435195815382	0,037
Nº 13	88005	16 x 4 x 4	100	8435195815399	0,038
	88006	17 x 4 x 4	100	8435195815405	0,038
Nº 16	88007	18 x 4 x 4	100	8435195815412	0,040
Nº 20	88008	20 x 4 x 4	100	8435195815429	0,054
	88026	24 x 4 x 4	100	8435195828122	0,130

SOLETAS DE CAUCHO CIEGAS



	Código	Medida	Caja	Código Barras	€ / Ud.
Nº 8	88010	12 x 4 x 4	100	8435195815443	0,037
	88011	13 x 4 x 4	100	8435195815450	0,037
Nº 11	88012	14 x 4 x 4	100	8435195815467	0,037
	88013	15 x 4 x 4	100	8435195815474	0,037
Nº 13	88014	16 x 4 x 4	100	8435195815481	0,038
	88015	17 x 4 x 4	100	8435195815498	0,038
Nº 16	88016	18 x 4 x 4	100	8435195815504	0,046
Nº 20	88017	20 x 4 x 4	100	8435195815511	0,049
	88018	27 x 5 x 4	100	8435195844870	0,200

ESTUCHE DE SOLETAS DE CAUCHO

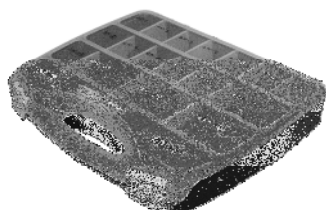

Código	Descripción	Caja	Código Barras	€ / Ud.
88009	16 medidas	800	8435195815436	36,79

• Contiene:

50 uds. de la Ref. 88001 a la 88008.

50 uds. de la Ref. 88010 a la 88017.



ACCESORIOS DE SELLADO

Rollo de teflón		230
Hilo sellador		230
Cáñamo		230
Pasta tipo Unibond		230
Lana de acero		230
Cinta adhesiva		231
Carrete estaño plata y cobre		231
Gel decapante		231

ACCESORIOS DE SELLADO



ROLLO DE TEFLÓN



	Código	Medida	Caja	Código Barras	€ / Ud.
	73001	12 m. x 12 mm. x 0,075 mm.	250	8435195812169	0,33
Gas	73003	12 m. x 12 mm. x 0,10 mm.	250	8435195812176	0,39
Polietileno	73004	50 m. x 19 mm. x 0,10 mm.	63	8435195812183	2,90

TEFLÓN LÍQUIDO P.T.F.E. SEAL

NUEVO
Producto



	Código	Medida	Caja	Código Barras	€ / Ud.
	99069	50 gr.	1	8435195846461	17,50
	99070	100 gr.	1	8435195848083	21,94

HILO SELLADOR DE TUBERÍAS



	Código	Medida	Caja	Código Barras	€ / Ud.
	73005	160 m.	10	8435195815634	25,63



	Código	Medida	Caja	Código Barras	€ / Ud.
	73006	50 m.	10	8435195815702	13,85

MADEJA DE CÁÑAMO

	Código	Medida	Caja	Código Barras	€ / Ud.
	73007	200 gr.	1	8435195822694	4,28



PASTA TIPO UNIBOND PARA ROSCAR CON CÁÑAMO



	Código	Medida	Caja	Código Barras	€ / Ud.
	73008	400 gr.	1	8435195822700	8,30

ACCESORIOS DE SELLADO



CINTA ADHESIVA



Código	Medida	Caja	Código Barras	€ / Ud.
73015	50 m. x 50 mm.	10	8435195827798	9,07
73016	10 m. x 50 mm.	10	8435195827804	2,98
73017	25 m. x 50 mm.	10	8435195827811	7,96

CARRETE ESTAÑO PLATA TIPO MAR-PLUS



Código	Descripción	Caja	Código Barras	€ / Ud.
49096	3,5% - 250 gr.	10	8435195806526	15,60
49097	6% - 250 gr.	10	8435195806533	16,99

CARRETE ESTAÑO COBRE PARA SOLDAR GAS TIPO MAR-PLUS



Código	Descripción	Caja	Código Barras	€ / Ud.
49095	6% - 250 gr.	10	8435195838619	32,80

GEL DECAPANTE FLUX



Código	Descripción	Caja	Código Barras	€ / Ud.
49098	100 gr.	10	8435195806540	3,60

BOLSA DE LANA ACERO



Código	Medida	Caja	Código Barras	€ / Ud.
73009	63 grs.	1	8435195824995	2,99



ACCESORIOS PARA GAS

Reguladores de butano		234
Goma de butano		234
Gas hermeto y soldar		235
Soportes y tapas de contador		239

ACCESORIOS PARA GAS



REGULADOR BOTELLA DE BUTANO



Código	Descripción	Caja	Código Barras	€ / Ud.
73030	Doméstico	1	8435195827828	15,48

- Regulador para botella doméstica.
- Presión salida regulada 30 mbar.
- Caudal 2,5 kg/h.
- Salida a manguera 9 mm. Ø interior.
- Standard K-30.



Código	Descripción	Caja	Código Barras	€ / Ud.
73032	Con corte	1	8435195827842	19,47

- Regulador para botella doméstica.
- Presión salida regulada 30 mbar.
- Caudal 2,5 kg/h.
- Salida a manguera 9 mm. Ø interior.
- Con corte por exceso de flujo.



Código	Descripción	Caja	Código Barras	€ / Ud.
73031	Salida libre	1	8435195827835	29,98

- Presión salida regulada hasta 1,7 bar.
- Mando negro.
- Sistema acople rápido.
- Salida rosca izquierda 21,8.

RACORD ACOPLAMIENTO REGULADOR

NUOVO
Prodotto



Código	Descripción	Caja	Código Barras	€ / Ud.
73033	rosca izq. 21,8	1	8435195848069	3,64

- Rácord acoplamiento para botella o regulador con rosca izq. 21,8 conjunta.
- Para mangueras de 8-9 mm Ø interior.

MANGUERA PARA GAS BUTANO



Código	Descripción	Caja	Código Barras	€ / Ud.
73036	60 m.	1	8435195827859	96,00



Código	Descripción	Caja	Código Barras	€ / Ud.
73037	1,5 m. con 2 abrazaderas	1	8435195827866	4,83

ACCESORIOS PARA GAS

Gas hermeto



UNIÓN HERMETO CROMO

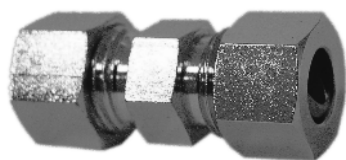

Código	Medida	Caja	Código Barras	€ / Ud.
89002	10 x 10	25	8435195816006	3,49
89003	12 x 12	25	8435195816013	4,93

	Código	Medida	Caja	Código Barras	€ / Ud.
Reducida	89006	10 x 12	25	8435195816037	4,92

REDUCCIÓN HERMETO CROMO

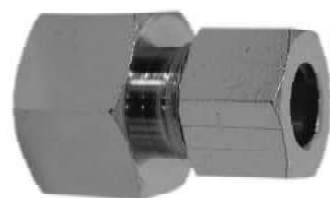

Código	Medida	Caja	Código Barras	€ / Ud.
89007	1/2" x 10	25	8435195816044	3,39
89008	1/2" x 12	25	8435195816051	3,73
89009	3/4" x 10	25	8435195816068	3,82
89010	3/4" x 12	25	8435195816075	5,15

BOQUILLA HERMETO CROMO

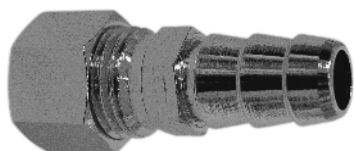

Código	Medida	Caja	Código Barras	€ / Ud.
89012	10 Ø	25	8435195816082	3,15
89013	12 Ø	25	8435195816099	2,99

CODO HERMETO CROMO



Código	Medida	Caja	Código Barras	€ / Ud.
89017	10 x 10	25	8435195816198	5,71
89018	12 x 12	25	8435195816204	5,51

TE HERMETO CROMO

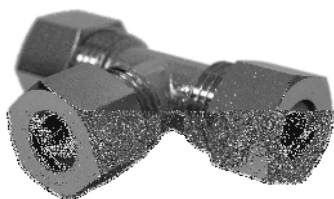

Código	Medida	Caja	Código Barras	€ / Ud.
89021	10 x 10 x 10	25	8435195816211	7,71
89022	12 x 12 x 12	25	8435195816228	6,53

ACCESORIOS PARA GAS

Gas soldar



UNIÓN SOLDAR S/COLOR

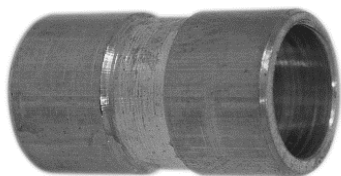

Código	Medida	Caja	Código Barras	€ / Ud.
89046	10 x 10	50	8435195816389	1,09
89047	12 x 12	50	8435195816396	0,89

Reducida	89048	10 x 12	50	8435195816402	0,94
-----------------	--------------	---------	----	---------------	-------------

BOQUILLA LISA SOLDAR S/COLOR

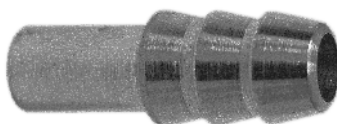

Código	Medida	Caja	Código Barras	€ / Ud.
89015	10 Ø	50	8435195816105	0,98
89016	12 Ø	50	8435195816112	1,08

BOQUILLA SOLDAR S/COLOR

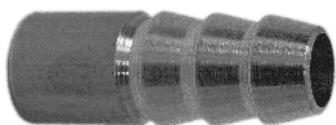

Código	Medida	Caja	Código Barras	€ / Ud.
89050	10 Ø	50	8435195816129	0,97
89051	12 Ø	50	8435195816136	1,18

BOQUILLA SOLDAR CANARIAS S/COLOR

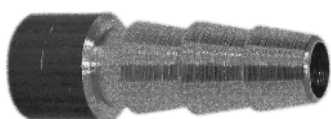

Código	Medida	Caja	Código Barras	€ / Ud.
89052	10 Ø	50	8435195816143	0,23

CODO SOLDAR S/COLOR



Código	Medida	Caja	Código Barras	€ / Ud.
89071	10 x 10	25	8435195816150	2,62
89073	12 x 12	25	8435195816167	2,89

TE SOLDAR S/COLOR



Código	Medida	Caja	Código Barras	€ / Ud.
89072	10 x 10 x 10	25	8435195816174	2,99
89074	12 x 12 x 12	25	8435195816181	3,93

ACCESORIOS PARA GAS



TUERCA HERMETO CROMO



Código	Medida	Caja	Código Barras	€ / Ud.
89024	10 Ø	100	8435195816235	0,93
89025	12 Ø	100	8435195816242	0,91

BICONO HERMETO LATÓN

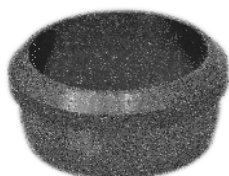

Código	Medida	Caja	Código Barras	€ / Ud.
89027	10 Ø	100	8435195816280	0,37
89028	12 Ø	100	8435195816297	0,51

TUERCA VÁLVULA GAS SOLDAR CROMO



Código	Medida	Caja	Código Barras	€ / Ud.
89026	10 Ø	25	8435195816259	0,70

MANGUITO VÁLVULA GAS SOLDAR LATÓN



Código	Medida	Caja	Código Barras	€ / Ud.
89044	10 Ø	25	8435195816266	0,62

Código	Descripción	Caja	Código Barras	€ / Ud.
89043	Junta manguito	25	8435195816273	0,10

MANGUITO SOLDAR S/COLOR

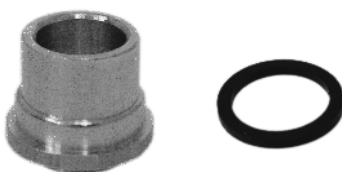

Código	Medida	Caja	Código Barras	€ / Ud.
89038	20/150 x 10 Ø	100	8435195816341	0,79
89039	20/150 x 12 Ø	100	8435195816358	0,87
89040	1/2" x 14 Ø	100	8435195816365	0,72
89041	1/2" x 15 Ø	100	8435195816372	0,75

Código	Descripción	Caja	Código Barras	€ / Ud.
89042	Junta manguito	100	8435195815337	0,10

TUERCA CONEXIÓN GAS JUNTA PLANA CROMO

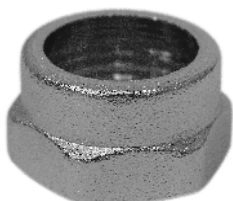

Código	Medida	Caja	Código Barras	€ / Ud.
89033	20/150 x 15 Ø	100	8435195816303	1,46
89034	21,8 izq. X 15 Ø	100	8435195816310	1,46
89035	1/2" x 15 Ø	100	8435195816327	1,33
89036	1/2" x 17 Ø	100	8435195816334	1,16

CONJUNTO TUERCA Y BICONO COMPRESIÓN

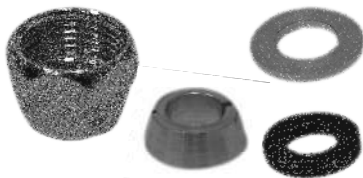

Código	Medida	Caja	Código Barras	€ / Ud.
99361	3/8" x 10 Ø	50	8435195812237	2,92
99364	1/2" x 10 Ø	50	8435195812244	2,88

ACCESORIOS PARA GAS



VÁLVULA HERMETO GAS BUTANO



Código	Medida	Caja	Código Barras	€ / Ud.
89056	10 x 10	120	8435195816556	14,29
89057	12 x 12	120	8435195816563	13,06

VÁLVULA SOLDAR GAS BUTANO



Código	Medida	Caja	Código Barras	€ / Ud.
89053	10 x 10	120	8435195816532	16,05
89054	12 x 12	120	8435195816549	16,96

VÁLVULA PROPANO NATURAL

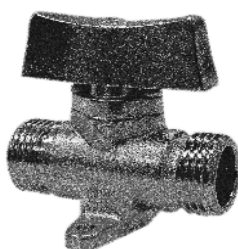

Código	Medida	Caja	Código Barras	€ / Ud.
89062	20/150 x 20/150	120	8435195816570	9,83
89063	21,8 izq. X 21,8 izq.	120	8435195816587	9,99
89064	1/2" x 1/2"	120	8435195816594	13,56
89066A	3/4" x 3/4"	60	8435195816600	15,20

- Conexión junta plana.

DERIVACIÓN BOQUILLA HERMETO CROMO



Código	Medida	Caja	Código Barras	€ / Ud.
89070	10 Ø	25	8435195816426	4,98

DERIVACIÓN BOQUILLA 3 SALIDAS S/COLOR



Código	Medida	Caja	Código Barras	€ / Ud.
89069	10 Ø	25	8435195816419	3,95

ABRAZADERA TUBO



Código	Medida	Caja	Código Barras	€ / Ud.
89066	10 Ø	500	8435195816433	0,73
89067	12 Ø	500	8435195816440	0,88

- Incluye taco y tornillo.

ABRAZADERA GOMA



Código	Medida	Caja	Código Barras	€ / Ud.
89068	14 x 16	100	8435195816457	0,39
89069A	16 x 18	100	8435195816464	0,49

ACCESORIOS PARA GAS



SOPORTE CONTADOR GAS FRONTAL

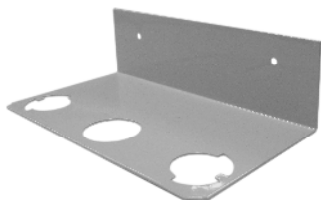

Código	Medida	Caja	Código Barras	€ / Ud.
89095	21,5 x 11,5 x 6 cm.	50	8435195816471	2,95

- Blanco.

SOPORTE CONTADOR GAS LATERAL

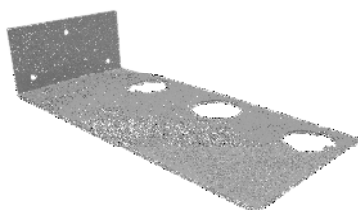

Código	Medida	Caja	Código Barras	€ / Ud.
89096	27 x 12 x 6 cm.	40	8435195816488	3,14

- Blanco.

TAPA PARA CONTADOR DE GAS

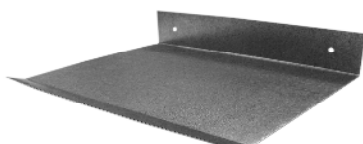



Código	Descripción	Caja	Código Barras	€ / Ud.
890101	Frontal	50	8435195816495	4,25
890102	Lateral	40	8435195816501	3,99
890103	Especial	40	8435195816518	2,97
890104	Separadora	30	8435195816525	4,54

- Chapa galvanizada.



ACCESORIOS DE VENTILACIÓN

Rejillas		242
Difusores		244

ACCESORIOS VENTILACIÓN

Rejillas metálicas



REJILLA EMPOTRAR



	Código	Descripción	Caja	Código Barras	€ / Ud.
17 x 17	60001	Blanco	100	8435195808940	2,70
	60002	Aluminio	100	8435195808957	2,35
	60003	Color madera	100	8435195808964	2,82
	60004	Aluminio blanco	100	8435195808971	2,82



	Código	Descripción	Caja	Código Barras	€ / Ud.
20 x 20	60005	Blanco	80	8435195808988	2,72
	60006	Aluminio	80	8435195808995	2,60
	60007	Aluminio blanco	80	8435195809008	3,43

REJILLA PLANA



	Código	Descripción	Caja	Código Barras	€ / Ud.
10 x 10	60011	Blanco	100	8435195809015	0,89
	60012	Aluminio	100	8435195809022	0,80
	60014	Color madera	100	8435195809046	0,99
	60013	Aluminio blanco	100	8435195809039	1,26

15 x 15	60501	Blanco	100	8435195809091	1,50
	60502	Aluminio	100	8435195809107	1,40
	60503	Color madera	100	8435195809114	1,40
	60504	Aluminio blanco	100	8435195809121	1,60

17 x 17	60506	Blanco	100	8435195809138	1,58
	60507	Aluminio	100	8435195809145	1,52
	60508	Color madera	100	8435195809152	2,21
	60509	Aluminio blanco	100	8435195809169	1,83

20 x 20	60511	Blanco	100	8435195809176	1,93
	60512	Aluminio	100	8435195809183	1,82
	60514	Color madera	100	8435195809206	2,48
	60513	Aluminio blanco	100	8435195809190	2,48

REJILLA PLANA



	Código	Descripción	Caja	Código Barras	€ / Ud.
20 x 10	60016	Blanco	100	8435195809053	1,60
	60017	Aluminio	100	8435195809060	1,30
	60019	Color madera	100	8435195809084	1,35
	60018	Aluminio blanco	100	8435195809077	1,35



	Código	Descripción	Caja	Código Barras	€ / Ud.
15 X 30	60515	Blanco	100	8435195809213	2,80
	60516	Aluminio	100	8435195809220	1,90
	60517	Color madera	100	8435195809237	2,37
	60505	Aluminio blanco	100	8435195809244	2,85

ACCESORIOS VENTILACIÓN

Rejillas ABS



REJILLA EMPOTRAR CUADRADA

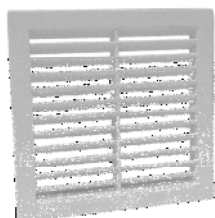

	Código	Descripción	Caja	Código Barras	€ / Ud.
15 x 15 Sin cierre	60528	Blanco	50	8435195809312	1,75

	Código	Descripción	Caja	Código Barras	€ / Ud.
17 x 17 Sin cierre	60518	Blanco	50	8435195809251	1,43
	60519	Color madera	50	8435195809268	1,43



	Código	Descripción	Caja	Código Barras	€ / Ud.
17 x 17 Con cierre	60533	Blanco	50	8435195841282	2,68

	Código	Descripción	Caja	Código Barras	€ / Ud.
20 x 20 Con cierre	60534	Blanco	50	8435195841299	3,56

MARCO REJILLA CUADRADA



	Código	Descripción	Caja	Código Barras	€ / Ud.
15 x 15	60529	Blanco	50	8435195809367	0,84

	Código	Descripción	Caja	Código Barras	€ / Ud.
17 x 17	60522	Blanco	50	8435195809329	0,80

REJILLA EMPOTRAR RECTANGULAR



	Código	Descripción	Caja	Código Barras	€ / Ud.
22 x 9,5 Sin cierre	60520	Blanco	100	8435195809275	1,70
	60521	Color madera	100	8435195809282	1,68

	Código	Descripción	Caja	Código Barras	€ / Ud.
22 x 9,5 Con cierre	60536	Blanco	50	8435195841312	2,39

MARCO REJILLA RECTANGULAR



	Código	Descripción	Caja	Código Barras	€ / Ud.
22 x 9,5	60524	Blanco	50	8435195809343	0,62
	60525	Color madera	50	8435195809350	0,66

REJILLA EMPOTRAR REDONDA



	Código	Descripción	Caja	Código Barras	€ / Ud.
15 cm. Ø	60526	Blanco	100	8435195809299	2,20
	60527	Color madera	100	8435195809305	1,67

MARCO REJILLA REDONDA



	Código	Descripción	Caja	Código Barras	€ / Ud.
15 cm. Ø	60530	Blanco	50	8435195809374	1,15

ACCESORIOS VENTILACIÓN

Rejillas ABS y difusores



REJILLA Y MARCO



	Código	Descripción	Caja	Código Barras	€ / Ud.
17 x 17 Sin cierre	60537	Blanco	50	8435195841329	2,67



	Código	Descripción	Caja	Código Barras	€ / Ud.
20 x 20 Sin cierre	60539	Blanco	50	8435195841336	3,35



	Código	Descripción	Caja	Código Barras	€ / Ud.
22 x 9,5 Sin cierre	60540	Blanco	50	8435195841343	2,53



	Código	Descripción	Caja	Código Barras	€ / Ud.
15 cm. Ø	60541	Blanco	50	8435195841350	2,82

MOSQUITERA REJILLA

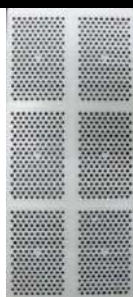

	Código	Descripción	Caja	Código Barras	€ / Ud.
22 x 9,5	60532	Blanco	50	8435195833751	0,71

DIFUSOR 2 DISCOS HIERRO BLANCO



	Código	Medida	Caja	Código Barras	€ / Ud.
	61001	100 Ø	64	8435195809398	4,09
	61002	110 Ø	64	8435195809404	3,98
	61003	120 Ø	64	8435195809411	4,49
	61004	125 Ø	64	8435195809428	3,98
	61005	130 Ø	64	8435195809435	3,98

DIFUSOR 3 DISCOS HIERRO BLANCO



	Código	Medida	Caja	Código Barras	€ / Ud.
	61101	100 Ø	48	8435195809442	3,98
	61102	110 Ø	48	8435195809459	4,52
	61103	120 Ø	48	8435195809466	4,99
	61104	125 Ø	48	8435195809473	5,15
	61105	130 Ø	48	8435195809480	5,55

DIFUSOR 3 DISCOS ALUMINIO BLANCO



	Código	Medida	Caja	Código Barras	€ / Ud.
	61120	100 Ø	18	8435195825008	11,36
	61121	110 Ø	18	8435195825015	11,36
	61122	120 Ø	18	8435195825022	11,34
	61123	125 Ø	18	8435195825039	11,36
	61124	130 Ø	18	8435195825046	11,36



SUMIDEROS, CALDERETAS Y BOTE SIFÓNICO

Sumideros



246

Calderetas



246

Bote sifónico



246

SUMIDEROS, CALDERETAS Y BOTE SIFÓNICO



SUMIDERO DE LATÓN CROMADO



Código	Medida	Caja	Código Barras	€ / Ud.
25522	10 x 10	2	8435195817812	19,72

SUMIDERO SIFÓNICO PVC

	Código	Medida	Caja	Código Barras	€ / Ud.
10 x 10	25534	Salida 50 Vertical/Horizontal	2	8435195824353	7,18

	Código	Medida	Caja	Código Barras	€ / Ud.
15 x 15	25535	Salida 75 - 50	2	8435195817829	8,96

	Código	Medida	Caja	Código Barras	€ / Ud.
20 x 20	25536	Salida 110 - 90	2	8435195817836	8,96

	Código	Medida	Caja	Código Barras	€ / Ud.
25 x 25	25537	Salida 110 - 90	2	8435195817843	10,53



CALDERETA SIFÓNICA PVC

	Código	Medida	Caja	Código Barras	€ / Ud.
10 x 10	25542	Salida 50 Vertical/Horizontal	2	8435195824360	6,50

	Código	Medida	Caja	Código Barras	€ / Ud.
15 X 15	25538	Salida 75 - 50	2	8435195817850	8,92

	Código	Medida	Caja	Código Barras	€ / Ud.
20 x 20	25539	Salida 110 - 90	2	8435195817867	15,26

	Código	Medida	Caja	Código Barras	€ / Ud.
25 x 25	25540	Salida 110 - 90	2	8435195817874	16,08



BOTE SIFÓNICO PVC



Código	Descripción	Caja	Código Barras	€ / Ud.
25541	110 mm.	2	8435195817881	6,62



ACCESORIOS DE COBRE

Racor recto		248
Racor curvo		250
Manguitos		251
Codos		253
Tapón Hembra		254
Curva de 90°		254
Curva de 45°		255
Curvas desviación		255
Te H-H-H		256

ACCESORIOS DE COBRE



RACOR CON ALOJAMIENTO DE JUNTAS sin precinto

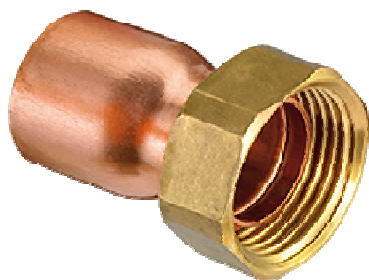

Código	Medida	Caja	Código Barras	€ / Ud.
49201	10 x 3/8"	25	8435195828436	1,36
49202	12 x 3/8"	25	8435195828443	1,42
49206	12 x 1/2"	25	8435195828450	1,27
49207	14 x 1/2"	25	8435195828467	1,11
49212	14 x 3/4"	25	8435195838701	1,80
49204	15 x 3/8"	25	8435195828474	1,23
49208	15 x 1/2"	25	8435195828481	1,29
49213	15 x 3/4"	25	8435195828498	2,16
49209	16 x 1/2"	25	8435195828504	1,26
49214	16 x 3/4"	25	8435195828511	1,96
49210	18 x 1/2"	25	8435195828528	1,74
49215	18 x 3/4"	25	8435195828535	2,05
49211	22 x 1/2"	25	8435195828542	3,20
49216	22 x 3/4"	25	8435195828559	2,29
49217	22 x 1"	10	8435195828566	3,35
49219	28 x 3/4"	25	8435195838718	4,74
49218	28 x 1"	10	8435195828580	4,52
49221	28 x 1 1/4"	10	8435195828597	6,54
49222	35 x 1 1/4"	10	8435195828603	7,43
49224	42 x 1 1/2"	10	8435195828610	9,74
49226	54 x 2"	5	8435195828627	14,43

RACOR CON JUNTA PLANA sin precinto

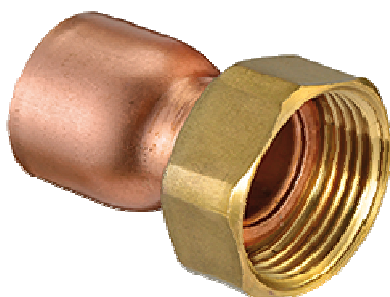

Código	Medida	Caja	Código Barras	€ / Ud.
49234	12 x 1/2"	25	8435195838770	1,25
49236	15 x 1/2"	25	8435195828634	1,34
49241	15 x 3/4"	25	8435195828641	2,16
49242	16 x 3/4"	25	8435195838817	1,96
49238	18 x 1/2"	25	8435195828658	1,73
49243	18 x 3/4"	25	8435195828665	2,05
49244	22 x 1/2"	25	8435195828672	3,38
49239	22 x 3/4"	25	8435195828689	2,71
49246	22 x 1"	25	8435195828696	4,36
49245	28 x 3/4"	25	8435195828702	4,97
49247	28 x 1"	25	8435195828719	4,19
49248	28 x 1 1/4"	25	8435195828726	5,25
49249	35 x 1 1/4"	25	8435195828733	7,12
49250	42 x 1 1/2"	25	8435195828740	10,16
49252	54 x 2"	25	8435195828757	18,93

ACCESORIOS DE COBRE



RACOR CON ALOJAMIENTO DE JUNTAS con precinto

RECTO 359GCU Con precinto

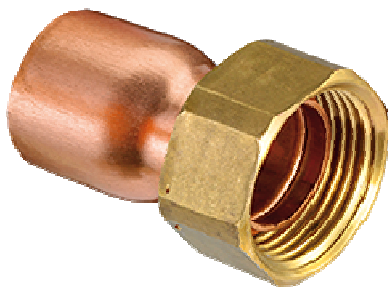

Código	Medida	Caja	Código Barras	€ / Ud.
49262	12 x 1/2"	25	8435195828764	1,71
49263	14 x 1/2"	25	8435195828771	1,30
49264	15 x 1/2"	25	8435195828788	1,61
49270	15 x 3/4"	25	8435195828825	2,47
49265	16 x 1/2"	25	8435195828795	1,33
49267	18 x 1/2"	25	8435195828801	1,99
49271	18 x 3/4"	25	8435195828832	2,34
49286	18 x 1"	25	8435195838916	3,18
49268	22 x 1/2"	25	8435195828818	2,79
49272	22 x 3/4"	25	8435195828849	2,61
49281	22 x 7/8"	25	8435195838862	2,77
49273	28 x 3/4"	25	8435195828856	5,12
49276	28 x 1"	10	8435195828863	3,32
49277	28 x 1 1/4"	10	8435195828870	5,25
49278	35 x 1 1/4"	10	8435195828887	7,87
49280	42 x 1 1/2"	10	8435195828894	10,80
49283	42 x 2"	10	8435195838886	14,96
49282	64 x 2 1/2"	10	8435195838879	36,38
49284	15 x 20/150	25	8435195838893	2,00
49285	18 x 20/150	25	8435195838909	2,02

RACOR CON JUNTA PLANA con precinto

RECTO 359GCU Con precinto

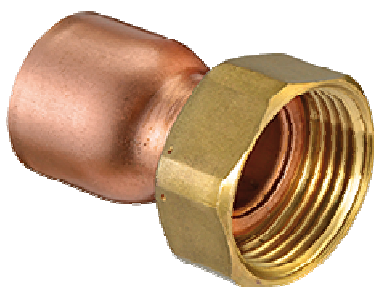

Código	Medida	Caja	Código Barras	€ / Ud.
49301	12 x 3/8"	25	8435195828900	1,59
49302	12 x 1/2"	25	8435195828917	2,45
49304	15 x 1/2"	25	8435195828924	1,61
49309	15 x 3/4"	25	8435195828931	2,65
49305	16 x 1/2"	25	8435195828948	1,85
49306	18 x 1/2"	25	8435195828955	1,99
49312	18 x 3/4"	25	8435195828962	2,52
49307	22 x 1/2"	25	8435195828979	5,17
49314	22 x 3/4"	25	8435195828986	2,56
49315	28 x 3/4"	25	8435195828993	12,96
49316	28 x 1"	10	8435195829006	5,71
49317	28 x 1 1/4"	10	8435195829013	5,84
49318	35 x 1 1/4"	10	8435195829020	9,89
49319	42 x 1 1/2"	10	8435195829037	10,38

ACCESORIOS DE COBRE



RACOR CURVO CON ALOJAMIENTO DE JUNTAS sin precinto

CURVO 2AGCU

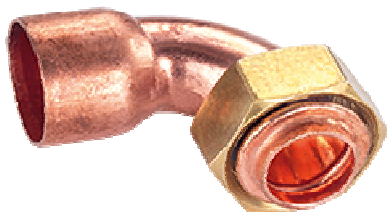

Código	Medida	Caja	Código Barras	€ / Ud.
49326	12 x 3/8"	25	8435195829044	1,74
49329	12 x 1/2"	25	8435195833768	2,09
49330	14 x 1/2"	25	8435195829068	1,68
49331	15 x 1/2"	25	8435195829075	2,07
49334	15 x 3/4"	25	8435195829358	3,25
49332	16 x 1/2"	25	8435195829082	1,76
49333	18 x 1/2"	25	8435195829099	2,34
49336	18 x 3/4"	25	8435195829105	2,62
49337	22 x 3/4"	25	8435195829112	3,83
49338	22 x 1"	10	8435195829129	4,23

RACOR CURVO CON JUNTA PLANA sin precinto

CURVO 2AGCU

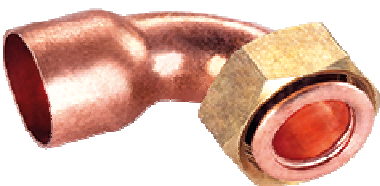

Código	Medida	Caja	Código Barras	€ / Ud.
49367	12 x 1/2"	25	8435195829198	2,16
49368	15 x 1/2"	25	8435195829204	2,05
49371	15 x 3/4"	25	8435195829228	2,60
49372	16 x 3/4"	25	8435195829235	2,70
49370	18 x 1/2"	25	8435195829211	2,34
49373	18 x 3/4"	25	8435195829242	3,42
49374	22 x 3/4"	25	8435195829259	3,56
49375	22 x 1"	10	8435195833775	4,28
49376	28 x 1"	10	8435195833782	4,88

RACOR CURVO CON ALOJAMIENTO DE JUNTAS con precinto

CURVO 2AGCU con precinto

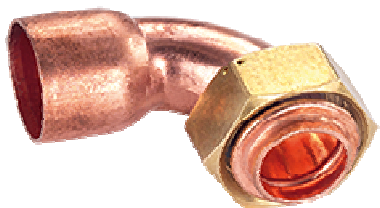

Código	Medida	Caja	Código Barras	€ / Ud.
49350	12 x 1/2"	25	8435195829136	2,49
49352	15 x 1/2"	25	8435195829143	1,86
49355	15 x 3/4"	25	8435195829167	2,86
49354	18 x 1/2"	25	8435195829150	2,14
49356	18 x 3/4"	25	8435195829174	3,84
49357	22 x 3/4"	25	8435195829181	2,99

RACOR CURVO CON JUNTA PLANA con precinto

CURVO 2AGCU con precinto

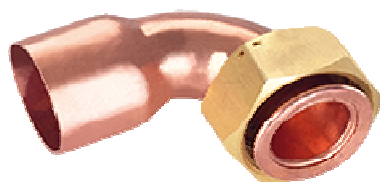

Código	Medida	Caja	Código Barras	€ / Ud.
49381	12 x 1/2"	25	8435195829266	2,25
49382	15 x 1/2"	25	8435195829273	2,25
49384	15 x 3/4"	25	8435195829297	3,33
49385	16 x 3/4"	25	8435195829303	3,39
49383	18 x 1/2"	25	8435195829280	2,59
49386	18 x 3/4"	25	8435195829310	3,25
49387	22 x 3/4"	25	8435195829327	3,38
49388	22 x 1"	25	8435195829334	4,96
49389	28 x 1"	25	8435195829341	5,54

ACCESORIOS DE COBRE



MANGUITO REDUCCION H-H

FIGURA 5240

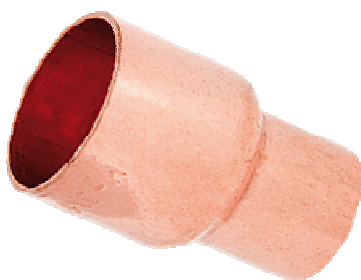

Código	Medida	Caja	Código Barras	€/ Ud.
49405	12 X 10	10	8435195829365	0,96
49406	14 X 12	10	8435195829372	0,59
49407	15 X 10	10	8435195829389	1,23
49408	15 X 12	10	8435195829396	0,72
49409	15 X 14	10	8435195829402	0,87
49410	16 X 12	10	8435195829419	0,72
49411	16 X 14	10	8435195829426	0,72
49412	16 X 15	10	8435195829433	1,61
49413	18 X 12	10	8435195829440	1,19
49414	18 X 14	10	8435195829457	0,89
49415	18 X 15	10	8435195829464	0,84
49416	18 X 16	10	8435195829471	0,86
49417	22 X 12	10	8435195829488	2,85
49418	22 X 14	10	8435195829495	1,41
49419	22 X 15	10	8435195829501	1,71
49420	22 X 16	10	8435195829518	1,27
49421	22 X 18	10	8435195829525	1,26
49422	28 X 12	10	8435195829532	4,56
49423	28 X 15	10	8435195829549	2,98
49424	28 X 18	10	8435195829556	2,57
49425	28 X 22	10	8435195829563	1,98
49427	35 X 18	10	8435195829570	7,63
49428	35 X 22	10	8435195829587	4,83
49429	35 X 28	10	8435195829594	5,25
49432	42 X 28	5	8435195829600	8,75
49435	42 X 35	5	8435195829617	6,50
49440	54 x 28	5	8435195839067	18,35
49436	54 x 35	5	8435195839043	14,70
49433	54 X 42	5	8435195829624	11,96
49437	64 x 35	1	8435195839050	21,78
49434	64 X 54	1	8435195829631	27,79
49441	67 X 54	1	8435195829648	24,69
49442	76 X 54	1	8435195829655	45,40
49443	76 X 64	1	8435195829662	39,83

ACCESORIOS DE COBRE



MANGUITO REDUCCION M-H

FIGURA 5243



Código	Medida	Caja	Código Barras	€/ Ud.
49448	12 x 10	10	8435195829679	1,22
49449	14 x 12	10	8435195829686	0,46
49450	15 x 10	10	8435195829693	1,23
49451	15 x 12	10	8435195829709	0,71
49452	15 x 14	10	8435195829716	0,81
49453	16 x 12	10	8435195829723	0,65
49454	16 x 14	10	8435195829730	0,52
49455	18 x 12	10	8435195829747	0,89
49456	18 x 14	10	8435195829754	0,76
49457	18 x 15	10	8435195829761	0,68
49458	18 x 16	10	8435195829778	0,68
49459	22 x 12	10	8435195829785	2,27
49460	22 x 14	10	8435195829792	0,98
49461	22 x 15	10	8435195829808	0,83
49462	22 x 16	10	8435195829815	0,85
49463	22 x 18	10	8435195829822	0,86
49464	28 x 12	10	8435195829839	3,38
49465	28 x 14	10	8435195829846	2,83
49466	28 x 15	10	8435195829853	2,25
49467	28 x 16	10	8435195829860	2,71
49468	28 x 18	10	8435195829877	2,21
49469	28 x 22	10	8435195829884	1,87
49470	35 x 15	10	8435195829891	8,94
49471	35 x 18	10	8435195829907	4,99
49472	35 x 22	10	8435195829914	4,72
49473	35 x 28	10	8435195829921	3,34
49474	42 x 18	5	8435195829938	21,45
49475	42 x 22	5	8435195829945	8,75
49476	42 x 28	5	8435195829952	6,93
49477	42 x 35	5	8435195829969	6,25
49478	54 x 28	5	8435195829976	16,60
49479	54 x 35	5	8435195829983	13,99
49480	54 x 42	5	8435195829990	11,42
49481	64 x 54	5	8435195830002	21,65
49482	67 x 54	5	8435195830019	25,93
49483	76 x 54	5	8435195830026	40,60
49484	76 x 64	5	8435195830033	35,18
49485	80 x 67	5	8435195830040	35,18

ACCESORIOS DE COBRE



MANGUITO CON TOPE H-H

FIGURA 5270

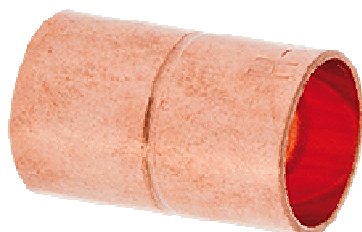

Código	Medida	Caja	Código Barras	€ / Ud.
49703	10	10	8435195830057	0,37
49704	12	10	8435195830064	0,36
49705	14	10	8435195830071	0,43
49706	15	10	8435195830088	0,36
49707	18	10	8435195830095	0,46
49708	22	10	8435195830101	0,75
49709	28	10	8435195830118	1,34
49710	35	10	8435195830125	2,69
49711	42	5	8435195830132	4,30
49712	54	5	8435195830149	9,67
49713	64	1	8435195830156	22,33
49714	66,7	1	8435195830163	31,59
49715	76,1	1	8435195830170	29,05
49716	80	1	8435195830187	33,62
49718	108	1	8435195830194	92,61

CODO 90° H-H

FIGURA 5090



Código	Medida	Caja	Código Barras	€ / Ud.
49600	10	10	8435195830200	0,74
49601	12	10	8435195830217	0,77
49602	14	10	8435195830224	0,67
49603	15	10	8435195830231	0,77
49604	16	10	8435195830248	0,83
49605	18	10	8435195830255	0,95
49606	22	10	8435195830262	1,87
49607	28	10	8435195830279	3,27
49608	35	5	8435195830286	6,50
49609	42	5	8435195830293	10,22
49610	54	1	8435195830309	19,53
49611	64	1	8435195830316	48,75
49612	66,7	1	8435195830323	71,80
49613	76,1	1	8435195830330	94,23
49614	80	1	8435195830347	104,05
49615	108	1	8435195830354	221,79

CODO 90° M-H

FIGURA 5092

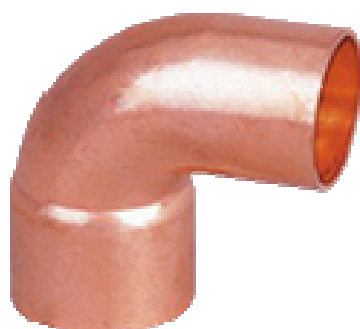

Código	Medida	Caja	Código Barras	€ / Ud.
49616	10	10	8435195830361	1,79
49617	12	10	8435195830378	0,84
49618	14	10	8435195830385	0,57
49619	15	10	8435195830392	0,47
49620	16	10	8435195830408	0,95
49621	18	10	8435195830415	1,05
49622	22	10	8435195830422	1,80
49623	28	10	8435195830439	3,12
49624	35	5	8435195830446	9,95
49625	42	5	8435195830453	14,09
49626	54	1	8435195830460	26,57
49627	64	1	8435195830477	69,74
49628	67	1	8435195830484	89,57

ACCESORIOS DE COBRE



TAPÓN H

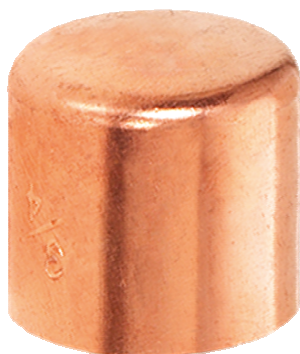

Código	Medida	Caja	Código Barras	€ / Ud.
49516	10	10	8435195831092	1,76
49517	12	10	8435195831108	0,85
49518	14	10	8435195831115	0,96
49519	15	10	8435195831122	0,60
49520	16	10	8435195831139	1,27
49521	18	10	8435195831146	0,86
49522	22	10	8435195831153	1,42
49523	28	10	8435195831160	2,28
49524	35	5	8435195831177	7,44
49525	42	5	8435195831184	8,25
49526	54	5	8435195831191	16,57

CURVA 90° H-H

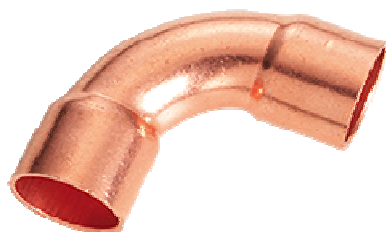

Código	Medida	Caja	Código Barras	€ / Ud.
49660	10	10	8435195830606	0,93
49661	12	10	8435195830613	0,72
49662	14	10	8435195830620	0,57
49663	15	10	8435195830637	0,98
49664	16	10	8435195830644	1,07
49665	18	10	8435195830651	1,39
49666	22	10	8435195830668	2,21
49667	28	10	8435195830675	3,56
49668	35	5	8435195830682	5,79
49669	42	5	8435195830699	13,38
49670	54	1	8435195830705	19,99
49671	64	1	8435195833799	65,52
49672	66,7	1	8435195833805	81,49
49673	76,1	1	8435195833812	113,12
49674	80	1	8435195833829	145,15

CURVA 90° M-H

FIGURA 5001A



Código	Medida	Caja	Código Barras	€ / Ud.
49643	10	10	8435195830491	1,98
49644	12	10	8435195830507	0,85
49645	14	10	8435195830514	0,65
49646	15	10	8435195830521	1,13
49647	16	10	8435195830538	0,74
49648	18	10	8435195830545	1,80
49649	22	10	8435195830552	2,63
49650	28	5	8435195830569	3,16
49651	35	5	8435195830576	8,99
49652	42	1	8435195830583	13,85
49653	54	1	8435195830590	25,74

ACCESORIOS DE COBRE



CURVA 45° H-H

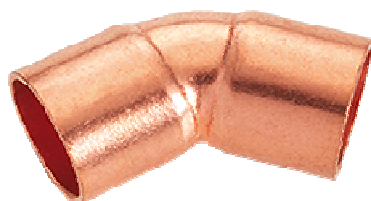

Código	Medida	Caja	Código Barras	€ / Ud.
49501	10	10	8435195830941	2,80
49502	12	10	8435195830958	0,92
49503	14	10	8435195830965	0,67
49504	15	10	8435195830972	0,61
49505	16	10	8435195830989	0,91
49506	18	10	8435195830996	1,33
49507	22	10	8435195831009	1,44
49508	28	10	8435195831016	2,64
49509	35	5	8435195831023	7,39
49510	42	5	8435195831030	9,97
49511	54	1	8435195831047	23,45
49512	64	1	8435195831054	80,17
49513	66,7	1	8435195831061	81,85
49514	76,1	1	8435195831078	97,47
49515	80	1	8435195831085	107,88

CURVA 45° M-H

FIGURA 5040

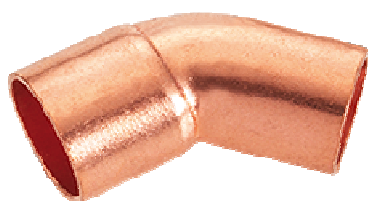

Código	Medida	Caja	Código Barras	€ / Ud.
49631	10	10	8435195830828	2,49
49632	12	10	8435195830835	0,77
49633	14	10	8435195830842	0,82
49634	15	10	8435195830859	0,61
49635	18	10	8435195830860	1,26
49636	22	10	8435195830873	1,19
49637	28	10	8435195830880	2,24
49638	35	5	8435195830897	8,03
49639	42	5	8435195830903	13,76
49640	54	1	8435195830910	23,04
49641	64	1	8435195830927	77,79
49642	67	1	8435195830934	88,94

CURVA DESVIACIÓN H-H

FIGURA 5085



Código	Medida	Caja	Código Barras	€ / Ud.
49688	12	10	8435195830712	4,94
49689	14	10	8435195830729	5,03
49690	15	10	8435195830736	2,98
49691	18	10	8435195830743	7,43
49692	22	10	8435195830750	8,56

CURVA DESVIACIÓN M-H

FIGURA 5086



Código	Medida	Caja	Código Barras	€ / Ud.
49680	12	10	8435195830767	4,32
49681	14	10	8435195830774	4,68
49682	15	10	8435195830781	2,18
49683	16	10	8435195830798	5,11
49684	18	10	8435195830804	5,28
49685	22	10	8435195830811	7,47

ACCESORIOS DE COBRE



TE RECTA H-H-H

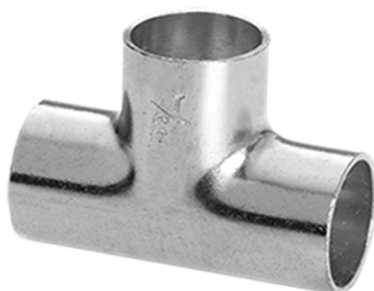

Código	Medida	Caja	Código Barras	€ / Ud.
49531	10	10	8435195831207	1,58
49532	12	10	8435195831214	1,12
49533	14	10	8435195831221	0,67
49534	15	10	8435195831238	1,05
49535	16	10	8435195831245	0,81
49536	18	10	8435195831252	1,85
49537	22	10	8435195831269	3,64
49538	28	10	8435195831276	3,99
49539	35	5	8435195831283	12,80
49540	42	5	8435195831290	17,71
49541	54	5	8435195831306	28,84
49542	64	1	8435195831313	86,32
49543	66,7	1	8435195831320	94,34
49544	76,1	1	8435195831337	110,22
49545	80	1	8435195831344	148,19
49546	108	1	8435195831351	252,56

TE REDUCIDA H-H-H

FIGURA 5130R



Código	Medida	Caja	Código Barras	€ / Ud.
49549	12 x 10 x 10	10	8435195831368	2,70
49550	12 x 14 x 12	10	8435195831375	1,79
49551	12 x 15 x 12	10	8435195831382	3,46
49552	14 x 12 x 12	10	8435195831399	1,28
49553	14 x 12 x 14	10	8435195831405	1,02
49554	14 x 14 x 12	10	8435195831412	1,20
49555	14 x 18 x 14	10	8435195839074	5,38
49557	15 x 12 x 12	10	8435195831429	6,54
49558	15 x 12 x 15	10	8435195831436	1,33
49559	15 x 15 x 12	10	8435195831443	3,33
49560	15 x 18 x 15	10	8435195831450	4,14
49561	15 x 22 x 15	10	8435195831467	6,82
49562	16 x 12 x 12	10	8435195831474	2,07
49563	16 x 12 x 14	10	8435195831481	1,59
49564	16 x 12 x 16	10	8435195831498	1,50
49565	16 x 14 x 12	10	8435195831504	2,24
49566	16 x 14 x 14	10	8435195831511	1,51
49567	16 x 14 x 16	10	8435195831528	1,29
49568	16 x 22 x 16	10	8435195839081	4,89
49569	18 x 12 x 12	10	8435195831535	5,99
49570	18 x 12 x 15	10	8435195831542	10,69
49571	18 x 12 x 16	10	8435195831559	3,39
49572	18 x 12 x 18	10	8435195831566	2,24
49573	18 x 14 x 14	10	8435195831573	2,72
49574	18 x 14 x 18	10	8435195831580	1,51
49575	18 x 15 x 12	10	8435195831597	6,66
49576	18 x 15 x 15	10	8435195831603	1,85
49577	18 x 15 x 18	10	8435195831610	1,66
49578	18 x 16 x 16	10	8435195831627	2,86
49579	18 x 16 x 18	10	8435195831634	2,64
49580	18 x 18 x 12	10	8435195831641	7,23
49581	18 x 18 x 14	10	8435195831658	2,80
49582	18 x 18 x 15	10	8435195831665	2,02

ACCESORIOS DE COBRE



TE REDUCIDA H-H-H

FIGURA 5130R



Código	Medida	Caja	Código Barras	€ / Ud.
49583	18 x 22 x 18	10	8435195831672	4,43
49584	18 x 28 x 18	10	8435195831689	2,78
49585	22 x 12 x 12	10	8435195831696	7,11
49586	22 x 12 x 22	10	8435195831702	5,60
49587	22 x 14 x 14	10	8435195831719	5,50
49588	22 x 14 x 22	10	8435195831726	2,55
49590	22 x 15 x 15	10	8435195831733	2,98
49591	22 x 15 x 18	10	8435195831740	3,30
49593	22 x 15 x 22	10	8435195831757	1,46
49594	22 x 16 x 16	10	8435195831764	4,38
49596	22 x 16 x 22	10	8435195831771	2,66
49597	22 x 18 x 15	10	8435195831788	6,19
49598	22 x 18 x 18	10	8435195831795	3,45
49599	22 x 18 x 22	10	8435195831801	3,53
49806	22 x 22 x 12	10	8435195831818	8,20
49807	22 x 22 x 15	10	8435195831825	4,36
49808	22 x 22 x 18	10	8435195831832	5,09
49809	22 x 28 x 22	10	8435195831849	8,61
49810	28 x 12 x 28	10	8435195831856	10,73
49811	28 x 15 x 15	10	8435195831863	11,04
49812	28 x 15 x 22	10	8435195831870	8,07
49813	28 x 15 x 28	10	8435195831887	6,09
49814	28 x 16 x 28	10	8435195831894	6,98
49815	28 x 18 x 15	10	8435195831900	11,87
49816	28 x 18 x 18	10	8435195831917	12,03
49817	28 x 18 x 22	10	8435195831924	8,04
49818	28 x 18 x 28	10	8435195831931	5,51
49819	28 x 22 x 15	10	8435195831948	12,61
49820	28 x 22 x 18	10	8435195831955	11,39
49821	28 x 22 x 22	10	8435195831962	6,57
49822	28 x 22 x 28	10	8435195831979	3,70
49823	28 x 28 x 15	10	8435195831986	12,55
49824	28 x 28 x 18	10	8435195831993	10,85
49825	28 x 28 x 22	10	8435195832006	8,88
49826	28 x 35 x 28	1	8435195832013	16,48
49831	35 x 15 x 35	1	8435195832020	15,04
49832	35 x 18 x 35	1	8435195832037	19,22
49589	35 x 22 x 35	1	8435195832044	10,05
49834	35 x 22 x 28	1	8435195832051	13,92
49835	35 x 28 x 22	1	8435195832068	20,89
49836	35 x 28 x 28	1	8435195832075	14,27
49837	35 x 28 x 35	1	8435195832082	14,31
49838	35 x 35 x 22	1	8435195832099	25,50
49839	35 x 35 x 28	1	8435195832105	24,09
49592	42 x 22 x 42	1	8435195832112	21,77
49840	42 x 28 x 42	1	8435195832129	24,42
49841	42 x 35 x 35	1	8435195832136	39,15
49842	42 x 35 x 42	1	8435195832143	30,21
49843	42 x 42 x 28	1	8435195832150	41,60
49595	54 x 22 x 54	1	8435195832167	83,36
49852	54 x 28 x 54	1	8435195832174	58,48
49853	54 x 35 x 54	1	8435195832181	52,61
49854	54 x 42 x 54	1	8435195832198	53,05
49851	64 x 42 x 64	1	8435195832204	83,36

CONDICIONES GENERALES DE VENTA



CATÁLOGO

Los precios indicados en este catálogo son los vigentes a fecha de su edición (Junio 2019) anulando tarifas, ofertas y precios especiales anteriores.

MEDITERRANEA DE VALVULAS se reserva el derecho de modificación en cualquier momento y sin previo aviso en caso de variación en sus condiciones de aprovisionamiento o fabricación.

En caso de estar interesado en que le notifiquemos cualquier modificación que se produzca en el mismo, deberá enviarnos un correo electrónico a nuestra dirección info@meval.es, indicando en el apartado "Asunto" la palabra "Altalista" y en el cuerpo la denominación del cliente que nos lo envía. De esta forma, entrará en una lista de correo interna, por la cual se le notificará cualquier variación que se produzca en nuestros productos, y muy especialmente, en nuestros precios.

Las imágenes mostradas en la tarifa son orientativas para facilitar la identificación de cada artículo, lo que no significa que la pieza a suministrar puede no ser exactamente igual a la mostrada en la misma.

IMPUESTOS

En los precios de esta tarifa no va incluido el I.V.A. Cualquier otro tipo de impuesto será siempre a cargo del comprador.

PORTES

Para pedidos superiores a 300 euros netos, a cualquier destino de península y Baleares, se enviarán a portes pagados.

Para pedidos inferiores a 300 euros netos, se cargarán 9 euros en factura en concepto de portes o se enviará a portes debidos siempre que el comprador así lo indique.

Los pedidos con destinos Ceuta, Melilla y Canarias superiores a 1.200 € se enviarán a portes pagados.

La empresa no se hace cargo de las reexpediciones de recaderos o agencias locales, cuyos gastos irán a cargo del destinatario. No obstante, en el caso de que el pedido sea superior a 400 euros netos, la reexpedición sí irá a cargo de Meval.

Los pedidos con carácter urgente o que necesiten de otra agencia de transporte distinta a la que Meval tiene contratada, irán a cargo del comprador.

EMBALAJE

Todos los pedidos se enviarán libres de gastos de embalaje, siempre que el pedido se ajuste a los embalajes indicados en tarifa.

CONDICIONES DE VENTA

A convenir entre ambas partes.

CONDICIONES GENERALES DE VENTA



FORMA DE PAGO

El pago será efectuado en las condiciones pactadas con el comprador y en los plazos estipulados con el mismo.

GARANTIA

Queda limitada exclusivamente al reemplazamiento del material reconocido como defectuoso por el personal técnico de Meval, sin indemnización.

En el caso de producirse un siniestro, **MEDITERRANEA DE VALVULAS** se hará responsable única y exclusivamente cuando el defecto sea de fabricación de nuestros productos. De ser así, es condición obligatoria que el damnificado dé parte a nuestra empresa en el momento del siniestro, para proceder a la activación del procedimiento de peritación. En caso contrario la empresa no se hará cargo de los daños ocasionados.

DEVOLUCIONES Y RECLAMACIONES

Únicamente se admitirán devoluciones y reclamaciones dentro de los 30 días de la fecha de recepción de la mercancía. En caso de devolución, siempre y cuando el material sea devuelto en las mismas condiciones que se envió.

Las devoluciones a portes debidos, solo se admitirán a través de la agencia que **MEDITERRANEA DE VALVULAS** determine.

COMPETENCIA JURIDICA

Ambas partes se someten para cualquier litigio a los juzgados y tribunales de VALENCIA.

CLÁUSULA DE PROTECCION DE DATOS

Según lo dispuesto por el Reglamento (UE) 2016/679 del Parlamento Europeo y del consejo del 27 de abril de 2016 relativo a la protección de las personas físicas en lo que respecta al tratamiento de datos personales y a la libre circulación de estos datos, le informamos que tratamos la información que nos facilita con el fin de prestarles el servicio solicitado, realizar la facturación del mismo y llevar las gestiones fiscales exigidas por la ley. Los datos proporcionados se conservaran mientras se mantenga la relación comercial o durante los años necesarios para cumplir con las obligaciones legales. Los datos no se cederán a terceros salvo en los casos en que exista una obligación legal. Usted tiene derecho a obtener confirmación sobre si en MEDITERRANEA DE VALVULAS SL estamos tratando sus datos personales por tanto tiene derecho a ejercer los derechos de acceso, rectificación, limitación de tratamiento, supresión, portabilidad y oposición/revocación, en los términos que establece la normativa vigente en materia de protección de datos dirigiendo su petición a info@meval.es, asimismo, podrá dirigirse a la Autoridad de Control competente para presentar la reclamación que considere oportuna. Asimismo nos autoriza para ofrecerle productos y servicios relacionados con los solicitados y fidelizarle como cliente.



MEDITERRÁNEA DE VÁLVULAS, S.L.

Pol. Ind. Torrubero - Av. Constitución. 5 - 46136 MUSEROS (Valencia) España

Tel. 96 185 82 03 - Fax 96 185 83 90

info@meval.es - www.meval.es