

SISTEMAS DE INSTALACIÓN

2023

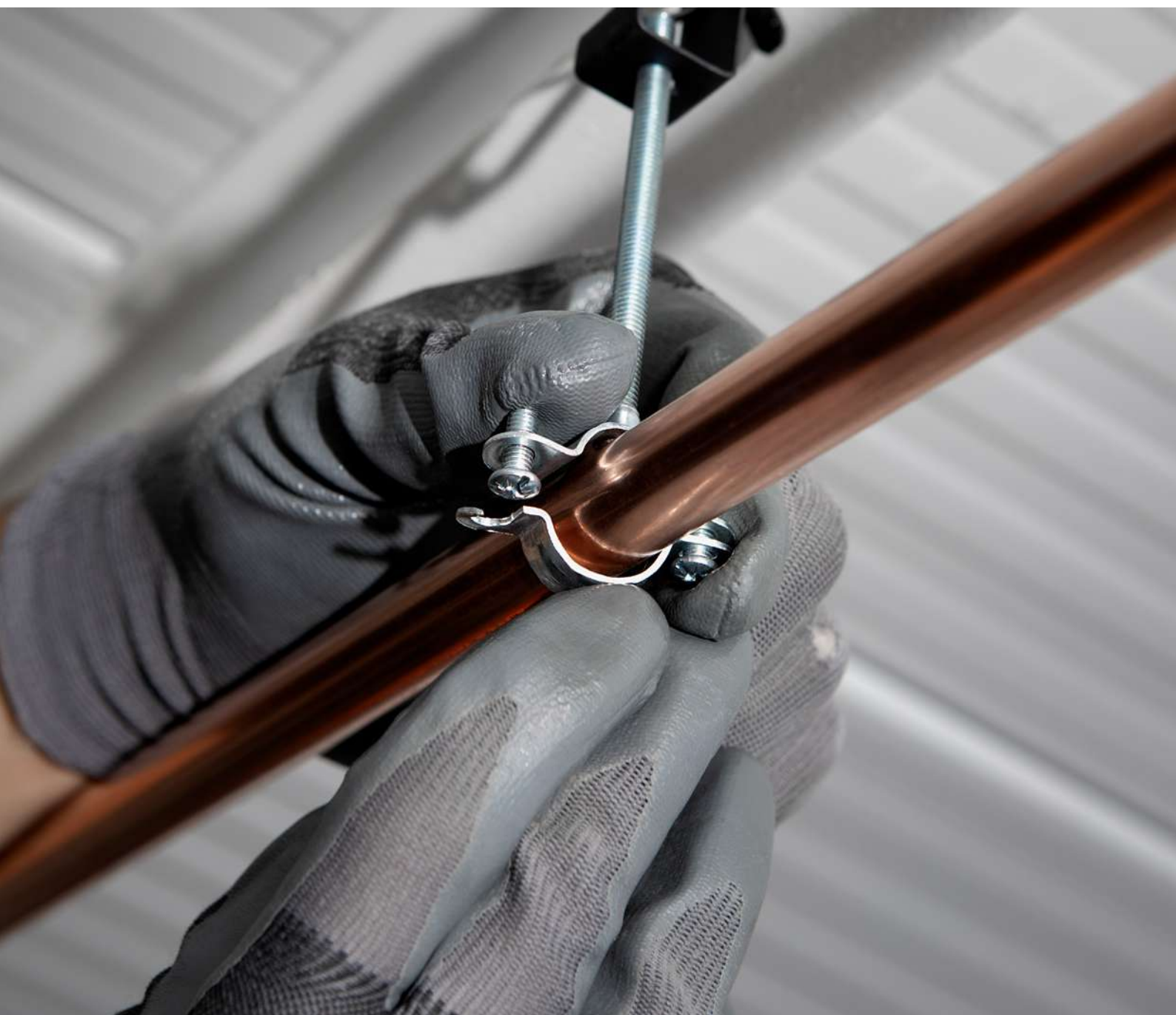

INDEX[®]
A PERFECT FIXING

A
PERFECT
FIXING

SISTEMAS DE INSTALACIÓN 2023

 | 02
PRESENTACIÓN

 | 73
ABRAZADERAS
PLÁSTICAS

 | 149
FIJACIONES
QUÍMICAS

 | 22
NOVEDADES

 | 87
PERFILERÍA
Y SOPORTACIÓN

 | 165
FIJACIONES
METÁLICAS

 | 24
ÍNDICE

 | 99
SISTEMAS DE INSTALACIÓN
Y FIJACIONES PARA PLACAS
SOLARES

 | 177
ACCESORIOS PARA CABLE
CADENA Y CERCADOS

 | 35
ABRAZADERAS
METÁLICAS PESADAS

 | 111
SISTEMAS DE FIJACIÓN
RÁPIDA EN VIGA

 | 189
FIJACIÓN
DIRECTA

 | 51
ABRAZADERAS
METÁLICAS LIGERAS

 | 115
FIJACIÓN SANITARIOS
Y CLIMATIZACIÓN

 | 195
TORNILLERÍA

 | 67
SISTEMAS PROTECCIÓN
CONTRA INCENDIOS

 | 121
VARILLA ROSCADA Y
ACCESORIOS DE FIJACIÓN

 | 217
GAMA
INOX

 | 71
SOPORTES
DE CANALÓN

 | 133
FIJACIONES PLÁSTICAS Y
PARA MATERIALES HUECOS

 | 239
CARACTERÍSTICAS
TÉCNICAS

INDEX[®]
A PERFECT FIXING



UNA FIJACIÓN PERFECTA
PARA TU NEGOCIO





En **INDEX®** somos fabricantes y proveedores industriales de sistemas de fijación, ofreciendo soluciones globales adaptadas a las necesidades de tu actividad.

PERO SOMOS MUCHO MÁS QUE ESO. SOMOS UN NUMEROSO EQUIPO HUMANO EN CONTINUA INVESTIGACIÓN, DESARROLLO E INNOVACIÓN Y, POR QUÉ NO DECIRLO, UN POCO OBSESIONADOS CON NUESTRO OBJETIVO: CONSEGUIR UNA FIJACIÓN PERFECTA.

Sea cual sea el tamaño de tu negocio, en **INDEX®** buscaremos una fijación perfecta para el mismo.



**¿POR QUÉ INDEX[®]
ES UNA FIJACIÓN
PERFECTA PARA
TU NEGOCIO?**

En **INDEX**[®] creemos que no hay imposibles cuando se trata de perseguir la perfección. Por eso realizamos continuas inversiones en nuevos productos, homologaciones, procesos productivos y medios tecnológicos para responder a todas las demandas del mercado.

Estas son sólo algunas de las razones por las que
**INDEX[®] MARCA
LA DIFERENCIA**



DISPONIBILIDAD Y AMPLIA GAMA DE PRODUCTO

Más de 10.000 referencias con stock permanente garantizado.



TRABAJAMOS CON EL CANAL

Vendemos a través del canal distribuidor, lo que nos permite conocer el mercado de primera mano.



SOMOS EXPERTOS FABRICANTES

Más de 35 años fabricando sistemas de fijación, nos permite garantizar la máxima calidad en nuestros productos, el mejor servicio y un coste global competitivo.



CALIDAD CERTIFICADA

Contamos con los certificados y homologaciones más importantes, verificando que todos nuestros productos cumplan los más altos estándares de calidad.



PRESENCIA INTERNACIONAL

Somos una empresa global, con ventas en más de 90 países en los 5 continentes y con instalaciones en España, China y México.



SERVICIOS DE INGENIERÍA Y SOPORTE TÉCNICO

Apoyamos a nuestros clientes y a sus clientes en el diseño y cálculo de fijaciones, visitas a obra conjunta y formaciones técnicas sobre temas relacionados con el mundo de la fijación.



SERVICIO DE CALIDAD AL CLIENTE

Nuestros clientes son el centro de todo lo que hacemos. Disponemos de un equipo de más de 300 personas a su servicio.



INDEX SPACE ESTUDIO

Sea cual sea el negocio de nuestros clientes, tenemos una solución expositiva para el mismo.



DISPONIBILIDAD Y AMPLIA GAMA DE PRODUCTO

Somos especialistas en anclajes, tornillos, abrazaderas, sistemas de instalación... Disponemos de la más amplia gama de producto, con más de 10.000 referencias, con un stock permanente garantizado en nuestras instalaciones de España, China y México (más de 45.000m²).



**TENEMOS TODO
LO QUE PUEDES
NECESITAR A NIVEL
DE FIJACIÓN,
APOSTANDO POR
LA INCORPORACIÓN
CONSTANTE DE
NUEVOS PRODUCTOS:
anclajes, tornillos,
abrazaderas, sistemas
de instalación...**





SOMOS EXPERTOS FABRICANTES

Tenemos el control total del proceso productivo, que junto con nuestra experiencia de más de 35 años como fabricantes de sistemas de fijación, nos permite garantizarte la máxima calidad en nuestros productos, el mejor servicio y un coste global competitivo.



**MÁS DE 35 AÑOS
DE EXPERIENCIA**





PRESENCIA INTERNACIONAL

Vendemos en más de 90 países en los 5 continentes y nuestros productos están presentes en los proyectos de construcción más importantes a nivel internacional.





SERVICIO DE CALIDAD AL CLIENTE

Para garantizarte una fijación perfecta, contamos con un equipo de más de 300 personas a tu servicio y unas instalaciones de más de 45.000 m² y 22.000 pallets de capacidad, garantizando un plazo de entrega de 24-48 horas y una respuesta rápida a cualquier tipo de necesidad que puedas tener.



**MÁS DE 300 PERSONAS
A TU SERVICIO**





TRABAJAMOS CON EL CANAL

En **INDEX®**, vendemos a través del canal distribuidor, lo que nos permite estar cerca de nuestros clientes. En este sentido, y para darte el mejor servicio, estamos presente en los canales más importantes, con gamas de productos adecuadas a cada uno de ellos y profesionales altamente cualificados para brindarte el mejor servicio.





CALIDAD CERTIFICADA

Nuestra obsesión por la perfección nos lleva a ampliar continuamente nuestras Certificaciones y Homologaciones de laboratorios independientes y de los principales organismos oficiales, que garantizan la máxima calidad tanto en productos como en sistemas de gestión.

HOMOLOGACIONES



Evaluación Técnica Europea



Conformidad Europea



Homologación Sísmica



ICC-ES®



Resistencia al fuego



Underwriters Laboratories



Homologación FM



Leadership in Energy and Environmental Design



Emisiones VOC reducidas



Water Regulations Advisory Scheme



PAHs



REACH



RoHS

CERTIFICACIONES



NUESTRO COMPROMISO DE CALIDAD A TRAVÉS DE LA CERTIFICACIÓN TÜV CERT GARANTIZA QUE INDEX® HA IMPLEMENTADO UN SISTEMA DE GESTIÓN SEGÚN LA NORMA ISO 9001:2015



SERVICIOS DE INGENIERÍA Y SOPORTE TÉCNICO

Te ofrecemos un completo asesoramiento técnico a través de un equipo de ingenieros especializados. Disponemos de un servicio S.A.T, software propio especializado y la más completa documentación técnica.

Y lo más importante, un equipo que te apoyará en el diseño, cálculo de fijaciones, visita a obra y formaciones técnicas sobre todo lo relacionado con el mundo de la fijación.

SERVICIO S.A.T. Y ASESORAMIENTO TÉCNICO



FORMACIÓN TÉCNICA



SERVICIOS DE INGENIERÍA Y REALIZACIÓN DE CÁLCULOS

SOFTWARE ESPECIALIZADO



INDEXcal



INDEXwood

Tenemos el software que mejor se adapta a tus necesidades en cada caso concreto.

INDEXcal, software para el cálculo de anclajes.

INDEXwood, software para el cálculo de conexiones de estructuras de madera.

INDEXmor, herramienta online que permite calcular el número de cartuchos químicos necesarios en función de diferentes parámetros.

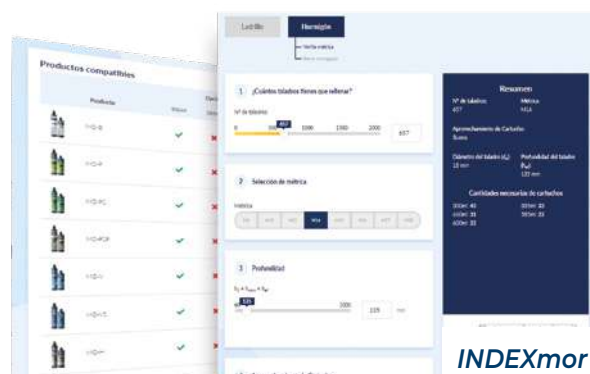

INDEXmor



AMPLIA DOCUMENTACIÓN TÉCNICA DISPONIBLE

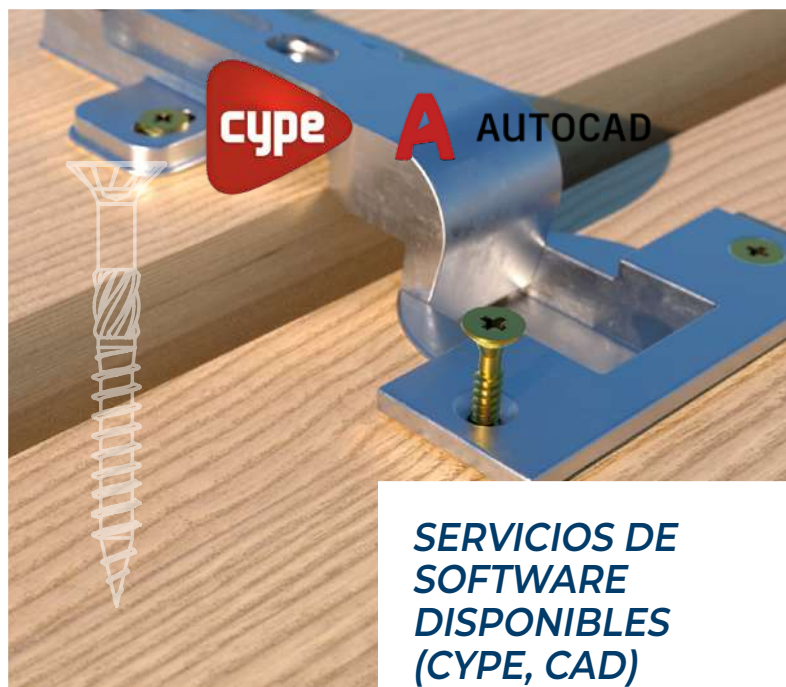

SERVICIOS DE SOFTWARE DISPONIBLES (CYPE, CAD)

INDEX Space Studio es el servicio de INDEX® dedicado al diseño personalizado de expositores y su implantación en los clientes.

Se trata de un servicio único en el mercado, 100% personalizable según las necesidades específicas del cliente (producto, formato de packaging, rotación y/o tipología de negocio), con el objetivo de rentabilizar al máximo el espacio de venta.





VENTAJAS Y CARACTERÍSTICAS

- **PERSONALIZABLE.** Servicio de implantaciones adaptadas a las necesidades de cada negocio.
- **IMPLANTACIONES 100% OPTIMIZADAS.** El sistema está ideado para obtener el máximo aprovechamiento del espacio en el punto de venta.
- **MÚLTIPLES SOLUCIONES.** Contamos con una amplia gama de soluciones expositivas. Góndolas, murales, cabeceras, islas, expositores promocionales...
- **CALIDAD Y SEGURIDAD.** Trabajamos con mobiliario de alta calidad que garantiza una máxima seguridad y una gran robustez de todos los elementos.
- **VERSATILIDAD.** El sistema es compatible con todos los productos y empaquetados de **INDEX®**.
- **OPTIMIZAMOS EL PROCESO DE REPOSICIÓN.** Conocedores de la importancia de facilitar la reposición y mantenimiento del lineal, el mobiliario y los packaging garantizan la máxima ergonomía y practicidad.
- **MÁXIMA VISIBILIDAD DEL PRODUCTO.** Diseñado para mejorar la decisión de compra del cliente final. Dispone de múltiples soluciones visuales de merchandising que complementan y mejoran la implantación.



¿CÓMO FUNCIONA?

INDEX SPACE STUDIO se trabaja en 6 fáciles pasos:

1. ANÁLISIS

El equipo comercial de **INDEX®** analiza junto al cliente las necesidades (espacio disponible, productos a incorporar, tipo de packaging...).

2. DISEÑO

Con la información obtenida, el equipo especializado en implantaciones optimiza y ordena el surtido.

3. PRESENTACIÓN

La presentación de la implantación propuesta está compuesta por una simulación 3D del lineal y un planograma, donde se refleja la colocación exacta del surtido seleccionado.

4. PREPARACIÓN Y EXPEDICIÓN

Para facilitar el montaje de los expositores, las expediciones de nuevas implantaciones se preparan de forma separada del resto de los pedidos habituales.

5. MONTAJE

El equipo especializado de montadores **INDEX®** se ocupa del montaje inicial íntegramente. Instalación del mobiliario, ubicación del producto e instalación de los elementos de merchandising.

6. MANTENIMIENTO Y SEGUIMIENTO

Aseguramos una revisión regular de cada lineal implantado, proponiendo posibles mejoras, manteniéndolo de forma óptima y actualizada y facilitando el trabajo de los reponedores.

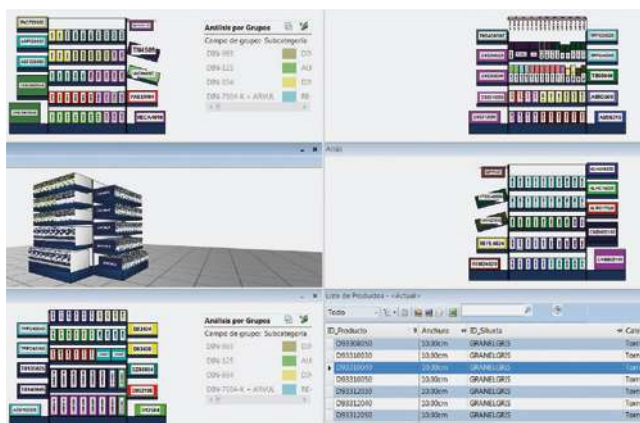



TIPOS DE LINEALES

GÓNDOLA



BALDAS INCLINADAS

Mejora la visualización de todos los productos. Recomendables para formatos de venta en caja ventana y venta INDEXmix.



GAVETAS GRANEL

Disponibles en metal y en plástico reciclado. Ideales para la presentación de productos a granel.



GANCHOS

Disponibles en 30, 40 y 50 cm. Recomendables para la colocación de blísters y productos EASYkits.



BALDAS RECTAS

Indicadas para la presentación de productos pesados como cajas profesionales, botes. Combinadas con separadores es perfecto para productos químicos, siliconas o espumas de poliuretano.

EXPOSITORES PROMOCIONALES Y OTROS



ISLA

Posibles combinaciones.

Medidas por módulo:
100 x 50 x 150 cm (A x F x H)



3 módulos
100 x 150 x 150 cm



4 módulos
100 x 200 x 150 cm



6 módulos
100 x 300 x 150 cm



8 módulos
100 x 400 x 150 cm

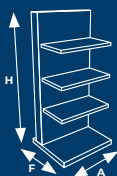

MEDIDAS DISPONIBLES EN STOCK

para expositores góndola/mural, cabeceras e islas:

- A: 100 cm.
- H: 165, 195 y 240 cm.

Otras medidas disponibles **bajo pedido.**

(Plazo de entrega de 4 semanas):

- A: 50, 70, 85 y 130 cm.
- H: 135, 150, 225 y 255 cm.
- F: 50 cm.

TIPOS DE PACKAGING

Conocedores de que cada usuario requiere unas necesidades concretas a nivel de cantidad y embalaje, en INDEX® hemos desarrollado diferentes alternativas para poder satisfacer a cada uno de ellos.

Todos nuestros packaging están fabricados con materiales reciclables y 100% sostenibles y respetuosos con el medioambiente.

Facilitamos la identificación y selección de los productos gracias a la codificación de color en las etiquetas.





CAJA PROFESIONAL

Preparada para los trabajos más exigentes gracias a su cartón reciclado de alta resistencia.



CAJA CON VENTANA

Visual, atractiva. Recomendado para implantar en lineales con autoventa.



BLÍSTER & EASYKITS

La mejor solución para cuando el cliente requiere comprar pocas cantidades.



BOTES DE PLÁSTICO

Son la solución perfecta para los grandes instaladores. Facilitan el manipulado en obra y cuentan con un atractivo diseño.



BOLSAS LIBRE SERVICIO

Listas para colocar en el lineal. Cantidades intermedias entre la caja profesional y el blíster.



GRANEL

Disponible para anclajes, tornillos, abrazaderas y bridas. Una buena solución para implantaciones con espacio de autoventa.



VISUAL MERCHANDISING

En INDEX ponemos a disposición de nuestros distribuidores una amplia gama de soportes para promocionar y comunicar nuestros productos en el punto de venta, como cabeceras de lineales, pósters, tótems, stickers, y ¡mucho más!.



CARTELAS SUPERIORES



CARTELAS PARA GÓNDOLAS BAJAS



ETIQUETEROS PARA BALDAS



STOPPER PARA BALDAS



VINILOS DE SUELO CORPORATIVOS



VINILOS DE SUELO PARA ISLAS



BANNERS PUBLICITARIOS



PÓSTER DE PRODUCTOS



LONAS DE GRAN FORMATO PARA EXTERIORES



BANNERS PUBLICITARIOS



PÓSTER DE PRODUCTOS

AMPLIAMOS GAMA

ACCESORIOS PARA CABLE Y CADENA

PÁGINA 177



SJ-Z **AMPLIACIÓN**
Sujetacable DIN-741 cincado



SJ-A4 **NEW**
Sujetacable DIN-741. Inoxidable A4



SJ-O **NEW**
Sujetacable oval



SJ-PD **NEW**
Sujetacable plano doble



SJ-PD A4 **NEW**
Sujetacable plano doble. Inoxidable A4



SJ-PS **NEW**
Sujetacable plano simple



SJ-PS A4 **NEW**
Sujetacable plano simple. Inoxidable A4



TS-GA **AMPLIACIÓN**
Sujetacable DIN-741 cincado



TS-GA A4 **NEW**
Tensor gancho/anilla DIN-1480. Inoxidable A4



TS-GG **NEW**
Tensor gancho/gancho. Cincado



TS-GG A4 **NEW**
Tensor gancho/gancho. Inoxidable A4



TS-AA **NEW**
Tensor anilla/anilla. Cincado



TS-AA A4 **NEW**
Tensor anilla/anilla. Inoxidable A4



TS-VS **NEW**
Tensor varilla soldar



EV-H **AMPLIACIÓN**
Cáncamo hembra d-582. Cincado



EV-H A4 **NEW**
Cáncamo hembra d-582. Inoxidable A4



EV-M **AMPLIACIÓN**
Anilla de elevacion macho DIN-580



EV-M A4 **NEW**
Anilla de elevacion macho DIN-580. Inoxidable A4



GR-Z **AMPLIACIÓN**
Grillete recto. Cincado



GR-A4 **NEW**
Grillete recto. Inoxidable A4



GS-Z **NEW**
Ese cincada



GD-Z **AMPLIACIÓN**
Guardacabos DIN-6899/A. Cincado



GD-A4 **NEW**
Guardacabos DIN-6899/A. Inoxidable A4



GI-Z **NEW**
Grillete lira cincado



GI-A4 **NEW**
Grillete lira. Inoxidable A4



MQ-B **NEW**
Mosqueton bombero



MQ-BS **NEW**
Mosqueton bombero con seguro

AMPLIAMOS GAMA

SISTEMAS DE INSTALACIÓN Y FIJACIONES PARA PLACAS SOLARES



Grapas y galgas para montaje de placas

NUEVA GALGA 30 mm



Perfiles, uniones, guías y empalmes para estructura de apoyo

NUEVOS PERFILES



Conectores + complementos para montaje de estructuras solares

NUEVAS MEDIDAS



Triángulos para instalación de placas solares



Accesorios regulables para la instalación de placas solares

NUEVAS SOLUCIONES



Accesorios de fijación directa para la instalación de placas solares

NUEVOS TORNILLOS



Accesorios de estanqueidad para la instalación de placas solares



Kits para instalaciones solares

NUEVOS KITS



PÁGINA 99

OTRAS NOVEDADES

MTH-AT

Homologado ETE Opt.7. Eje ATLANTIS C4-M. Clip ATLANTIS C4-M



PÁGINA 167

TXE

Tornillo hormigón hexagonal con punta Bimetal. Inoxidable A4



PÁGINA 171

HE-HO SDS y HE-HC SDS

Broca SDS con tope para HE-HO y HE-HC



PÁGINA 129

OTRAS NOVEDADES

TN4S-A y TN4S + TP-PO

Taco nvlon 4 seamentos. Collarín ancho



PÁGINA 140

NUEVAS MEDIDAS EN

THE y TFE

Anclaje de fijación directa en hormigón. Homologado ETE Opt.1. Cabeza hexagonal



PÁGINAS 170 y 172































ÍNDICE

Abrazaderas metálicas pesadas

AB-RA	38	
AB-IA	39	
AB-IR	39	
AB-RE	40	
AB-RE V	40	
AB-RE A2	41	
AB-RE A4	41	
AB-RI	42	
AB-RI V	42	
AB-RI A2	43	
AB-RI A4	43	
AB-RI DES	44	
PA-EX	44	
CO-AR	44	
AB-ICP	44	
AB-AIS 13	45	
AB-AIS 19	45	
AB-AIS 30	45	
AB-AIS 40	45	
AB-GA	46	
AB-M8	46	
AB-DE Z	47	
AB-DE G	47	
AB-DP Z	47	
AB-DP G	47	
AB-ZI	48	
AB-ZI A2	48	
AB-SA	49	
AB-GP	49	

Abrazaderas metálicas ligeras





AB-M6	54	
-------	----	---

AB-M6 Z	54	
AB-M6 A2	55	
AB-D6	55	
AB-D6 Z	55	
AB-6I	56	
AB-DI	56	
AB-M7 Z	57	
AB-D7 Z	57	
AB-7I Z	58	
AB-7ID Z	58	
AB-PI	59	
AB-PU	59	
AB-IP	60	
AB-SI	60	
AB-TO	60	
AB-SF	61	
AB-SF A2	61	
AB-SF IR	62	
AB-SF IRC	62	
AB-SF IRR	62	
CI-PE	62	
CI-PE A2	62	
CI-PR	63	
AB-CR	63	
AB-ITS	63	
AB-ITD	63	
AB-BU	64	
AB-GM	64	
AB-GS	65	
AB-GD	65	























Sistemas de protección contra incendios

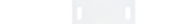











AB-PE	68		
AB-CH	68		
AN-CU	69		 
AB-CI	69		

Soportes para canalones



















TE-MO	72	
TE-GA	72	
TE-GR	72	
TE-PE	72	

Abrazaderas plásticas

BN-N	75		
BN-B	76		
BN-GR	77		
BN-VE	77		
BN-MA	77		
BN-AM	77		
BN-DT	78		
BN-AZ	78		
BN-RO	78		
TACOBRI N	79		
TACOBRI B	79		
TACOBRI G	79		
BN-ID	79		
BN-PL	79		
BN-BA	80		
AB-IN	80		
AB-ID	80		
AB-GU	81		
AB-MUG	81		
AB-PR	82		

AB-MS	82	
AB-MD	82	
AB-TS	83	
AB-TD	83	
AB-TC	83	
FI-CA AB	84	
FI-CA PS	84	
FI-CA PD	84	
FI-CA CL	84	
GR-NY BL	85	
GR-NY N	85	
GR-NY NT	85	

Perfilería y soportación

GP-Z	90	
GP-G	90	
GP-A2	90	
GP-PL	90	
GP-PVC	90	
GL-O	91	
GP-O	91	
SP-Z	91	
SP-V	91	
SP-H	92	
SP-HX	92	
TO-GU	92	
TO-GR	92	
TU-GU	92	
TU-GRA	93	
EG-Z	93	
EG-A2	93	
PU-Z	93	
PG-Z	93	

ÍNDICE

PG-A2	93		GP-XS	100	
SO-TP	94		EMP-XS	100	
GP-X 21	94		GP-VD	101	
GP-X 41	94		PSA-A	101	
SP-X	94		PSA-UN	101	
SP-RX	94		PSA-AV	101	
SO-TP	95		PSE-A	101	
SP-UX	95		KFS-FI	102	
PR-X	95		KFS-FL	102	
RE-SX	95		PSE-UN	102	
TG-X	95		PSE-C	102	
TO-GRX	95		PSE-CUN	102	
TU-GX	96		TU-RX A2	103	
TU-MU	96		DIN-603 A2	103	
TU-RX	96		DIN-6921 A2	103	
TU-RXA	96		DIN-6923 A2	103	
EG-X	96		DIN-127 A2	103	
SC-RX	97		TPA-R	104	
EMP-X	97		TPA-P	104	
RT-X	97		TRP-XS	104	
UN-PX	97		NU-XS	104	
UN-EX	97		KFS-MA	105	
UN-TX	98		KFS-AU	105	
PG-X	98		KFS-RV	105	
AB-GX	98		GS-TC	106	
UN-CO	98		GS-TU	106	
SO-PG	98		STR	106	
Sistemas de instalación y fijaciones para placas solares			PMO	106	
KFR-SC	100		PMO-L	106	
PGS-A	100		TAC + ARVUL	107	
GM-A	100		TACBIMETAL+ARVULA2	107	
			MO-TL	107	

AUE NI + ARVUL	107	
MO-PC	107	
ARS-P	108	
DIN-7504-KRENI+ARVUL	108	
RE-TE	108	
ARS-S	108	
CS-B	108	
KC-PSA	109	
KC-PSD	109	
KC-PSC	109	
KC-GPX	109	
KC-GPD	110	
KT-PSE	110	
KT-GPX	110	

Sistemas de fijación rápida en viga

SU-MO	112
SU-CL	112
SU-VA	112
SU-CU	113
SU-AB	113
SU-CA	113



Fijación para sanitarios y climatización

RA-TRG	116
RA-TRI	116
RA-FRE	116
RA-FIN	116
RA-RO	117
RA-FEM	117
RA-RAY	117
RA-PES	117
SA-LN	118
SA-LH	118



SA-IL	118
SA-WZ	118
SA-WL	118
SA-CI	119
SA-WH	119
SA-WHM	119
SA-TE TB	119
SA-TE AL	119
CO-SO	120
CO-KS	120



Varilla roscada y accesorios de fijación

RV-ZN	122
RV-ZN 8.8	122
RV-A2	122
RV-2M	123
VR-SE	123
MA-HE	123
MA-RE	124
MA-RI	124
MA-MH	124
AB-TA	125
AB-TA B	125
AB-TA A2	125
AB-TG	126
TM-VR	126
ES-DR	126
TALA	127
TA-ME	127
ES-DA2	127
HE-HO	128
HE-A4	128

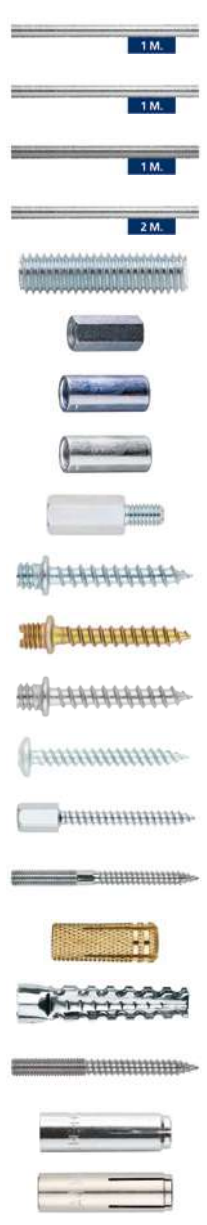

ÍNDICE

HE-CL		128			
TC-MA		128			
HE-C4		129			
HE-NO		129			
HE-HO SDS		129			
HE-HC SDS		129			
AB-TR		130			
AB-PM7		130			
AB-FP		130			
AB-FC		130			
PF-ZN		131			
PF-A4		131			

FIJACIONES PLÁSTICAS Y PARA MATERIALES HUECOS

T-NUX A		135		
T-NUX A A4		135		
T-NUX E		135		
T-NUX E A4		136		
T-NUX T		136		
T-FUX E		136		
T-NUX		136		
TC-CA		137		
TC-CA EP		137		
TC-SP		138		
TC-SP EP		138		
TN4S		139		
TN4S EP		139		
TN4S-A		140		
TN4S-A EP		140		
TACON		140		
TACOL		140		

TAPLA NY		141	
TAPLA ME		141	
MEDU		141	
TACOL-A		141	
ANCLA		142	
TAPLA ZK		142	
INPIN		143	
INPIS		143	
IN-CO		144	
IN-HE		144	
IN-SI		144	
BA-ES		145	
BA-GA		145	
CA-BA		145	
PA-ES		146	
PA-GA		146	
CA-PA		146	
TR-BL		147	
TR-13		147	
TR-15		147	

Fijaciones químicas

MO-PU		151			
MO-P+		151			
MO-PS+		151			
MO-PSP+		151			
MO-V		152			
MO-VS		152			
MO-H		152			
MO-HW		152			
MOPURE		153			
MOPUR3		153			

MOPISTO	154		
MOPISPR	154		
MOPISSI	154		
MOPISPUR6	154		
MOPISNEU	154		
MOPISP3	154		
MOBOMBA	154		
MORCANU	154		
MORCAPU	154		
MORCEPKIT	154		
MO-TN	154		
MO-ES	154		
MO-TR	154		
MO-TM	154		
MO-TL	154		
MO-PC	154		
CA-QU	155		
EQ-AC	155		
EQ-8.8	155		
EQ-A2	155		
EQ-A4	155		
MS-PR	157		
MS-TR	157		
MS-SF	157		
SI-PR	159		
SI-PRS	159		
SI-UNI	159		
SI-UNS	160		
SE-ACR	160		
MS-CA	160		
PU-SP	161		
PU-SC	161		

PU-TP	161		
PU-TPR	162		
PU-TC	162		
PU-FP	162		
PU-FC	163		
PU-EP	163		
PU-CL	163		
PU-PI	164		
PU-PI 2	164		
PU-CA	164		

Fijaciones metálicas

MTH	166			
MTH-AT	167			
MTH-A2	168			
MTH-A4	168			
MTA	169			
THE	170			
THA	170			
THP	171			
THT	171			
TXE	171			
TFE	172			
TFN	172			
TFS	173			
TFF	173			
TFM	173			
CH-TO	174			
CH-A2	174			
CH-PL	175			
CH-GA	175			
CH-AR	175			
CH-PI	176			

ÍNDICE

CH-INB		176	
CH-INN		176	

Accesorios para cable, cadena y cercados

SJ-Z		178	
SJ-A4		178	
SJ-O		178	
SJ-PS		179	
SJ-PS A4		179	
SJ-PD		179	
SJ-PD A4		179	
TS-GA		180	
TS-GA A4		180	
TS-AA		180	
TS-AA A4		180	
TS-GG		181	
TS-GG A4		181	
TS-VS		181	
EV-H		182	
EV-H A4		182	
EV-M		182	
EV-M A4		182	
GR-Z		183	
GR-A4		183	
GD-Z		184	
GD-A4		184	
GI-Z		184	
GI-A4		185	
GS-Z		185	
MQ-BS		185	
MQ-B		185	
CM-BP		186	



































































CM-BT		186	
CM-TA		186	
CM-TP		186	
CM-UN		186	
CM-TENSO		187	
CM-TENSOVE		187	
CM-TT		187	

Fijación directa

FG-GUN		190	
FG-GUNEL		190	
FG-CL		191	
FG-CLH		191	
FG-ARAM		191	
FG-ARAM EP		191	
FG-PLET		192	
AB-PID		192	
FG-ABRA		192	
FG-BASE		192	
FG-CAEL		193	
FG-CLCAR		193	
FG-IMAN		193	
FG-BAT		193	
FG-CAR		193	
FG-GAS		193	

Tornillería

DIN-7504-K		196	
DIN-7504-K A2		196	
DIN-7504-K + ARVUL		197	
DIN-7504-K CP + ARVUL		197	
AUE		198	
AUE + ARVUL		198	

ARVUL	199			MTH-A2	219		
ARVUL A2	199			CH-A2	220		
TP-PO B	200			CH-PI	220		
TP-PO Z	202			HE-A4	220		
DIN-7981 HP Z	204			EQ-A2	221		
DIN-571	205			EQ-A4	221		
DIN-571 A2	206			PF-A4	221		
571 TR	206			HE-C4	221		
DIN-933	207			T-NUX A A4	222		
DIN-933 A2	208			T-NUX E A4	222		
DIN-934	209			DIN-7504-K A2	222		
DIN-934 A2	209			ARVUL A2	223		
DIN-985	210			DIN-571 A2	223		
DIN-985 A2	210			DIN-933 A2	224		
DIN-6923	211			DIN-934 A2	225		
DIN-6923 A2	211			DIN-603 A2	225		
DIN-125	212			DIN-6921 A2	225		
DIN-125 A2	212			DIN-985 A2	226		
DIN-9021	213			DIN-125 A2	226		
DIN-9021 A2	213			DIN-6923 A2	226		
PU-PH	214			DIN-9021 A2	227		
PU-TO	214			DIN-127 A2	227		
PU-OX	215			AB-RE A2	228		
PU-PO	215			AB-RE A4	228		
PU-CU	215			AB-RI A2	228		
PU-PM	216			AB-RI A4	229		
DIN-603 A2	225			AB-ZI A2	229		
DIN-6921 A2	225			AB-ITS	229		
DIN-127 A2	227			AB-M6 A2	230		
Gama Inox				AB-SF A2	230		
MTH-A4	218			AB-ITD	230		





















































ÍNDICE

AB-SF IR	231	
AB-SF IRC	231	
AB-SF IRR	231	
CI-PE A2	231	
SA-IL	232	
SA-CI	232	
GP-A2	232	
EG-A2	232	
RV-A2	233	
MA-RI	233	
AB-TA A2	233	
PG-A2	233	
ES-DA2	234	
TU-RX A2	234	
TACBIMETAL+ARVULA2	234	
EV-H A4	235	
EV-M A4	235	
GD-A4	235	
SJ-PS A4	236	
SJ-PD A4	236	
GR-A4	236	
GI-A4	236	
TS-GA A4	237	
TS-AA A4	237	
TS-GC A4	237	

MATERIALES Y RECUBRIMIENTOS DE PRODUCTO

 Inoxidable A2	 Inoxidable A4	 Inoxidable AISI 430	 Bimetal	 Atlantis C4-M
 Atlantis C3-H	 Atlantis C3-M	 Atlantis C3-L	 Atlantis C2-H	 Atlantis C2-M
 Atlantis C2-L	 Bicromatado	 Cincado	 Cincado negro	 Cincado blanco
 Fosfatado	 Galvanizado azul	 Zamak	 Latón	 Cobre
 Pavonado	 Aluminio	 Polietileno	 Nylon	 PVC
 Plastificado negro	 Plastificado blanco	 Plastificado amarillo	 Polipropileno	 Butileno
 EPDM				

MATERIALES DE USO

 Carpintería aluminio	 Carpintería PVC	 Canalón	 Viga IPN	 Tubo ventilación
 Cartón yeso	 Cable	 Cadena	 Cuerda	 Tubo cromado
 Chapa - perfil pesado	 Ensamblaje Chapa	 Chapa - madera	 Fibrocemento	 Tubo butano
 Madera - metal	 Escayola	 Hormigón armado	 Hormigón fisurado	 Tubo fundición
 Hormigón	 Hormigón hueco	 Ladrillo macizo	 Tubo cobre	 Tubo gas
 Termoarcilla	 Piedra	 Ladrillo de adobe	 Tubo pvc	 Cable
 Madera noble	 Madera pino	 Hormigón celular	 Tubo plástico	 Tubo PPR
 Madera fina	 Panel de madera	 Ladrillo hueco	 Tubo inoxidable	 Tubo acero
 Placa alveolar	 Teja	 Instalación perfiles de aluminio	 Tubo incendios	 Tubo flexible
 SATE alta densidad	 SATE baja densidad	 Cerámico	 Azulejo	 Porcelanato
 Aluminio	 Vidrio	 Bloque de ladrillo		

HUELLAS















 Hexagonal	 Cuadrada	 Hexagonal con ranura	 Hexagonal con arandela estampada	 PH
 Ranura	 Allen	 TX	 PZ	

CARGAS









 Cargas ligeras	 Cargas medias	 Cargas altas	 Cargas muy altas
---	---	--	--

PROTECCIÓN FRENTE A LA CORROSIÓN

CATEGORÍAS DE CORROSIÓN

CATEGORÍAS DE CORROSIÓN	NIVEL DE CORROSIÓN	AMBIENTES TÍPICOS: EJEMPLOS DE ISO9223		RECUBRIMIENTOS DISPONIBLES INDEX®
		INTERIOR	EXTERIOR	
C1	MUY BAJO	Espacios calefaccionados con baja humedad relativa y contaminación insignificante, por ejemplo, oficinas, escuelas, museos.	Zona seca o fría, ambiente atmosférico con muy baja contaminación y tiempo de humedad, por ejemplo, ciertos desiertos, ártico central/ antártico.	 ZINC CINCADO  BLACK CINCADO NEGRO  WHITE CINCADO BLANCO  PH FOSFATADO  P YELLOW PLASTIFICADOS
C2	BAJO	Espacios sin calefacción con temperatura variable y humedad relativa. Baja frecuencia de condensación y baja contaminación, por ejemplo, almacenamiento, pabellones deportivos.	Zona templada, ambiente atmosférico con baja contaminación (SO ₂ : <5 g/m ³), por ejemplo, zonas rurales, pequeñas ciudades. Zona seca o fría, ambiente atmosférico con poco tiempo de humedad, por ejemplo desiertos, zonas subárticas.	 ATLANTIS C2-H  ATLANTIS C2-M  ATLANTIS C2-L  B YELLOW BICROMATADO  G GALVANIZADO ORGÁNICO AZUL
C3	MEDIO	Espacios con frecuencia moderada de condensación y contaminación moderada por el proceso de producción, por ejemplo, plantas de procesamiento de alimentos, lavanderías, cervecerías, lecherías.	Zona templada, ambiente atmosférico con contaminación media (SO ₂ : 5µ g/m ³ a 30µ g/m ³) o algún efecto de cloruros, por ejemplo, zonas urbanas, zonas costeras con baja deposición de cloruros. Zona tropical y subtropical, atmósfera con baja contaminación.	 ATLANTIS C3-H  ATLANTIS C3-M  ATLANTIS C3-L  INOX AISI 430 INOXIDABLE AISI 430
C4	ALTO	Espacios con alta frecuencia de condensación y alta contaminación por proceso de producción, por ejemplo, plantas de procesamiento industrial.	Zona templada, ambiente atmosférico con alta contaminación (SO ₂ : 30 g/m ³ a 90 g/m ³) o efecto sustancial de cloruros, por ejemplo, zonas urbanas contaminadas, zonas industriales, zonas costeras sin pulverización de agua salada (1-10 km) o, exposición a fuertes efectos de salinidad. Zona subtropical y tropical, atmósfera con contaminación media.	 ATLANTIS C4-M  A2 INOX AISI 304 INOXIDABLE A2 (AISI 304)
C5	MUY ALTO	Espacios con muy alta frecuencia de condensación y/o con alta contaminación por proceso de producción, por ejemplo, minas, cavernas con fines industriales, espacios sin ventilación en zonas subtropicales y tropicales.	Zona templada y subtropical, ambiente atmosférico con contaminación muy alta (SO ₂ : 90 g/m ³ a 250 g/m ³) y/o efecto significativo de cloruros, por ejemplo, zonas industriales, zonas costeras (0-1 km), instalaciones protegidas en la costa.	 A4 INOX AISI 316 INOXIDABLE A4 (AISI 316)

GUÍA RÁPIDA DE SELECCIÓN

		CATEGORÍAS DE CORROSIÓN				
		C1	C2	C3	C4	C5
CONDICIONES MEDIOAMBIENTALES Y/O ATMOSFÉRICAS	 INTERIORES SIN CONDENSACIÓN	✓				
	 INTERIORES CON CONDENSACIÓN TEMPORAL		✓			
	 EXTERIORES EN ZONAS RURALES CON MUY BAJA CONTAMINACIÓN		✓			
	 EXTERIORES CON BAJA CONTAMINACIÓN			✓		
	 EXTERIORES CON CONCENTRACIÓN MODERADA DE CONTAMINACIÓN				✓	
	 ÁREAS COSTERAS					✓
	 EXTERIORES CON FUERTE CONTAMINACIÓN INDUSTRIAL					✓
	 ZONAS CERCANAS A CARRETERAS					✓





















* La selección indicada en la tabla es para exposiciones esperadas de 25 años y siempre que cumplan con un mantenimiento adecuado.





















* En el caso de instalaciones con productos homologados, el uso en esos ambientes no está cubierto por la Aprobación Técnica Europea (ETA) de anclajes, donde se establece que solo los anclajes de acero inoxidable se pueden instalar en exteriores y garantizando una vida útil del anclaje de 50 años.



ABRAZADERAS METÁLICAS PESADAS



	MEDIDAS (mm)	CARGA RECOMENDADA kg	RECUBRIMIENTO	ESPESOR (mm)	ANCHURA (mm)	APERTURA	MANGUITO	HOMOLOGACIÓN	ISOFÓNICA	CTE	
AB-RA	APLICACIONES: Saneamiento Eléctrico									P. 38	
	∅ 15 - ∅ 125	80		1,5	20	Rápida lateral	M8	-	-	-	
AB-IA	APLICACIONES: ACS y AF, Gas, Saneamiento, Calefacción, Climatización, Eléctrico, Ventilación									P. 39	
	∅ 15 - ∅ 125	80		1,5	20	Rápida lateral	M8	-	✓	✓	
AB-IR	APLICACIONES: ACS y AF, Gas, Saneamiento, Calefacción, Climatización, Eléctrico, Ventilación									P. 39	
	∅ 15 - ∅ 60	60		1,25	19	Rápida vertical	M8	-	✓	✓	
AB-RE AB-RE V	APLICACIONES: Saneamiento, Eléctrico, Ventilación									P. 40	
	∅ 18 - ∅ 1250	150 - 200		1,8 - 2,3	19	Tornillo	M8 / M10	-	-	-	
AB-RI AB-RI V	APLICACIONES: ACS y AF, Gas, Saneamiento, Calefacción, Climatización, Eléctrico, Ventilación									P. 42	
	∅ 18 - ∅ 1250	150 - 200		1,8 - 2,3	19	Tornillo	M8 / M10	-	✓	✓	
AB-RE A2 AB-RE A4	APLICACIONES: ACS y AF, Gas, Saneamiento, Calefacción, Climatización, Eléctrico, Ventilación									P. 41	
	∅ 18 - ∅ 1250	150 - 200	 AB-RE A2	 AB-RE A4	1,8 - 2,3	19	Tornillo	M8 / M10	-	✓	✓
AB-RI A2 AB-RI A4	APLICACIONES: ACS y AF, Gas, Saneamiento, Calefacción, Climatización, Eléctrico, Ventilación									P. 43	
	∅ 18 - ∅ 1250	150 - 200	 AB-RI A2	 AB-RI A4	1,8 - 2,3	19	Tornillo	M8 / M10	-	✓	✓
AB-RI DES	APLICACIONES: Saneamiento, Eléctrico									P. 44	
	∅ 16 - ∅ 160	150		1,2 - 2,0	20	Rápida lateral	M8 / M10	-	✓	✓	
AB-ICP	APLICACIONES: ACS y AF, Gas, Saneamiento, Calefacción, Climatización, Eléctrico, Ventilación									P. 44	
	∅ 60 - ∅ 135	200		2,75 - 4,0	30 - 40	Tornillo	M8 / M10 M10 / M12 M12 / M16	-	✓	✓	

	MEDIDAS (mm)	CARGA RECOMENDADA kg	RECUBRIMIENTO	ESPESOR (mm)	ANCHURA (mm)	APERTURA	MANGUITO	HOMOLOGACIÓN	ISOFÓNICA	CTE
AB-AIS	APLICACIONES: ACS y AF, Gas, Saneamiento, Calefacción, Climatización, Eléctrico, Ventilación									P. 45
	Ø 10 - Ø 219	150 - 200		13 - 40	20 - 40	AB-AIS 13 & 19 Rápida lateral AB-AIS 30 & 40 Tornillo	M8 / M10 M8 / M10 M12 / M16	-	 	
AB-GA	APLICACIONES: Gas									P. 46
	Ø 18 - Ø 160	150 - 200		2	19	Tornillo	M8 ≤ Ø54 M8 / M10 > Ø54	De acuerdo a UNE-EN ISO 4892	-	-
AB-M8	APLICACIONES: Saneamiento, Desagüe									P. 46
	Ø 50 - Ø 315	100		1	28	Tornillo	M8	-	-	-
AB-DE Z AB-DE G	APLICACIONES: Saneamiento, Desagüe									P. 47
	Ø 75 - Ø 315	200	 	2,5	20	Tornillo	M8	-	-	-
			AB-DE Z AB-DE G							
AB-DP Z AB-DP G	APLICACIONES: Saneamiento, Desagüe									P. 47
	Ø 75 - Ø 250	200	 	2,5	20	Tornillo	-	-	-	-
			AB-DP Z AB-DP G							
AB-ZI	APLICACIONES: Gas, Saneamiento									P. 48
	Ø 16 - Ø 230	250 - 350		M6 - M8 - M10	-	-	-	-	-	-
AB-SA	APLICACIONES: Gas, Saneamiento									P. 49
	-	-		5 - 6	-	-	-	-	-	-
AB-GP	APLICACIONES: Saneamiento, Industrial									P. 49
	Ø 25 - Ø 235	-		0,6 - 1,8	18 - 25	Tornillo	-	-	-	-

AB-RA

Abrazadera reforzada M8 abierta

02
P. 245
Info.
Técnica

SANEAMIENTO



VENTAJAS

Tornillos con arandela plástica para evitar su pérdida
Tuerca soldada M8

CÓDIGO	MEDIDA	ØD(mm)	€/100	MEDIDA EN PULGADAS	CARGA MÁXIMA		
ABRA015	15 (M8)	12-16	81,647	1/4"	80	50	300
ABRA018	18 (M8)	15 - 19	81,987	3/8"	80	50	300
ABRA022	22 (M8)	20 - 25	87,677	1/2"	80	50	200
ABRA028	28 (M8)	26 - 30	91,337	3/4"	80	50	200
ABRA035	35 (M8)	32 - 36	97,197	1"	80	50	150
ABRA042	42 (M8)	38 - 43	102,327	1 1/4"	80	50	150
ABRA048	48 (M8)	47 - 51	112,093	1 1/2"	80	50	100
ABRA054	54 (M8)	53 - 58	117,787	-	80	25	100
ABRA060	60 (M8)	60 - 64	123,320	2"	80	25	75
ABRA075	75 (M8)	75 - 80	138,270	2 1/2"	80	25	50
ABRA090	90 (M8)	87 - 92	147,070	3"	80	25	50
ABRA100	100 (M8)	99 - 105	165,167	3 1/2"	80	25	50
ABRA110	110 (M8)	107 - 112	165,910	-	80	25	50
ABRA115	115 (M8)	113 - 118	190,960	4"	80	25	50
ABRA125	125 (M8)	125 - 130	190,683	4 1/2"	80	25	50

EJEMPLOS DE APLICACIÓN



Abrazadera reforzada isofónica M8 abierta

AB-IA

02 Info
Técnica
p. 245

SANEAMIENTO



CÓDIGO	MEDIDA	ØD(mm)	€/100	MEDIDA EN PULGADAS	CARGA MÁXIMA		
ABIA015	15 (M8)	12-16	90,620	1/4"	80	50	200
ABIA018	18 (M8)	15 - 19	95,940	3/8"	80	50	200
ABIA022	22 (M8)	20 - 25	101,833	1/2"	80	50	150
ABIA028	28 (M8)	26 - 30	106,283	3/4"	80	50	100
ABIA035	35 (M8)	32 - 36	113,623	1"	80	50	100
ABIA042	42 (M8)	38 - 43	126,320	1 1/4"	80	50	-
ABIA048	48 (M8)	47 - 51	143,963	1 1/2"	80	50	-
ABIA054	54 (M8)	53 - 58	150,320	-	80	25	50
ABIA060	60 (M8)	60 - 64	162,947	2"	80	25	50
ABIA075	75 (M8)	75 - 80	182,270	2 1/2"	80	25	50
ABIA090	90 (M8)	87 - 92	202,507	3"	80	25	50
ABIA100	100 (M8)	99 - 105	224,110	3 1/2"	80	25	50
ABIA110	110 (M8)	107 - 112	231,197	-	80	25	-
ABIA115	115 (M8)	113 - 118	267,217	4"	80	25	-
ABIA125	125 (M8)	125 - 130	285,937	4 1/2"	80	25	-



VENTAJAS

Tornillos con arandela plástica para evitar su pérdida
Tuerca soldada M8

EJEMPLOS DE APLICACIÓN

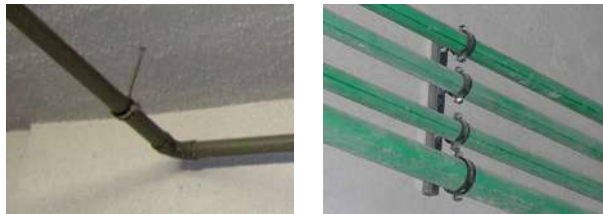



Abrazadera isofónica M8 instalación rápida

AB-IR

02 Info
Técnica
p. 245

SANEAMIENTO



CÓDIGO	MEDIDA	ØD(mm)	€/100	MEDIDA EN PULGADAS	CARGA MÁXIMA		
ABIRO15	15 (M8)	14 - 15	83,007	1/4"	60	50	300
ABIRO18	18 (M8)	16 - 19	88,763	3/8"	60	50	300
ABIRO22	22 (M8)	21 - 23	92,597	1/2"	60	50	200
ABIRO28	28 (M8)	26 - 28	102,240	3/4"	60	50	150
ABIRO35	35 (M8)	32 - 35	112,027	1"	60	50	100
ABIRO40	40 (M8)	40 - 43	126,383	1 1/4"	60	25	100
ABIRO48	48 (M8)	48 - 51	138,543	1 1/2"	60	25	100
ABIRO54	54 (M8)	52 - 56	145,970	-	60	25	75
ABIRO60	60 (M8)	57 - 60	153,267	2"	60	25	75



VENTAJAS

Un solo tornillo
Instalación rápida
Isofónica
De acuerdo al CTE

EJEMPLOS DE APLICACIÓN



AB-RE

Abrazadera reforzada M8 + M10

AB-RE

Cincada

02
P. 246
Info.
Técnica

SANEAMIENTO



EJEMPLOS DE APLICACIÓN



VENTAJAS

Tornillos con arandela plástica para evitar su pérdida
Reforzada

CÓDIGO	MEDIDA	ØD(MM)	€/100	MEDIDA EN PULGADAS	CARGA MÁXIMA		
ABRE018	18 (M8+M10)	15 - 19	106,270	3/8"	80	50	300
ABRE022	22 (M8+M10)	20 - 25	109,457	1/2"	80	50	200
ABRE028	28 (M8+M10)	26 - 30	121,530	3/4"	80	50	150
ABRE035	35 (M8+M10)	32 - 36	130,443	1"	80	50	100
ABRE040	40 (M8+M10)	38 - 43	136,933	1 1/4"	80	25	100
ABRE048	48 (M8+M10)	47 - 51	146,417	1 1/2"	80	25	100
ABRE054	54 (M8+M10)	53 - 56	156,187	-	80	25	75
ABRE060	60 (M8+M10)	60 - 64	165,250	2"	80	25	75
ABRE070	70 (M8+M10)	68 - 72	172,740	-	80	25	50
ABRE075	75 (M8+M10)	75 - 80	177,260	2 1/2"	150	25	50
ABRE083	83 (M8+M10)	81 - 86	184,913	-	150	25	-
ABRE090	90 (M8+M10)	87 - 92	198,990	3"	150	25	-
ABRE100	100 (M8+M10)	99 - 105	204,867	3 1/2"	150	25	-
ABRE110	110 (M8+M10)	107 - 112	222,203	-	150	25	-
ABRE115	115 (M8+M10)	113 - 118	250,263	4"	200	25	-
ABRE125	125 (M8+M10)	125 - 130	267,550	4 1/2"	200	25	-
ABRE133	133 (M8+M10)	132 - 137	293,047	-	200	25	-
ABRE140	140 (M8+M10)	138 - 142	331,697	5"	200	25	-
ABRE150	150 (M8+M10)	148 - 152	337,220	-	200	25	-
ABRE160	160 (M8+M10)	159 - 166	353,813	6"	200	25	-
ABRE180	180 (M8+M10)	179 - 184	375,510	-	200	25	-
ABRE200	200 (M8+M10)	199 - 212	408,403	-	200	25	-
ABRE220	220 (M8+M10)	215 - 226	465,540	8"	200	25	-
ABRE250	250 (M8+M10)	245 - 254	515,867	-	200	25	-
ABRE280	280 (M8+M10)	278 - 284	589,353	-	200	25	-
ABRE300	300 (M8+M10)	299 - 304	662,840	-	200	25	-
ABRE315	315 (M8+M10)	314 - 319	745,437	-	200	25	-
ABRE355	355 (M8+M10)	354 - 359	944,633	-	200	25	-

Bolsa autoservicio

CÓDIGO	MEDIDA	€/BOLSA	PCS	BOLSAS
LSABRETO22	22 (M8+M10)	4,684	2	5
LSABRETO28	28 (M8+M10)	4,794	2	5
LSABRETO35	35 (M8+M10)	4,902	2	5
LSABRETO40	40 (M8+M10)	5,032	2	5
LSABRETO48	48 (M8+M10)	4,934	2	5
LSABRETO60	60 (M8+M10)	5,165	2	5
LSABRETO75	75 (M8+M10)	5,421	2	5
LSABRETO90	90 (M8+M10)	6,653	2	5
LSABRET110	110 (M8+M10)	6,900	2	5
LSABRET125	125 (M8+M10)	7,977	2	4

KIT
AB-RE + ES-DR
+ T4S



AB-RE V

Cincada. Ventilación

SANEAMIENTO



CÓDIGO	MEDIDA	ØD(mm)	€/100	MEDIDA EN PULGADAS	CARGA MÁXIMA	
ABRE400	400 (M8+M10)	399 - 404	1.116,117	-	200	25
ABRE450	450 (M8+M10)	449 - 454	1.361,050	-	200	10
ABRE500	500 (M8+M10)	499 - 504	1.339,477	-	200	10
ABRE560	560 (M8+M10)	555 - 561	1.602,267	-	200	10
ABRE600	600 (M8+M10)	599 - 604	1.705,283	-	200	10
ABRE630	630 (M8+M10)	625 - 631	1.824,477	-	200	10
ABRE710	710 (M8+M10)	705 - 711	2.056,817	-	200	10
ABRE800	800 (M8+M10)	799 - 804	2.275,583	-	200	10
ABRE900	900 (M8+M10)	899 - 904	2.522,683	-	200	10
ABRE910	1000 (M8+M10)	999 - 1.004	2.826,213	-	200	10
ABRE911	1120 (M8+M10)	1.115 - 1.121	3.094,363	-	200	10
ABRE912	1250 (M8+M10)	1.245 - 1.251	3.398,440	-	200	10

Abrazadera reforzada M8 + M10

AB-RE

02
P. 247
Info
Técnica

INOXIDABLE



AB-RE A2

Inoxidable A2

CÓDIGO	MEDIDA	ØD(mm)	€/100	MEDIDA EN PULGADAS	CARGA MÁXIMA		
ABREA2018	18 (M8+M10)	15 - 18	381,287	3/8"	150	50	300
ABREA2022	22 (M8+M10)	20 - 24	400,983	1/2"	150	50	200
ABREA2028	28 (M8+M10)	26 - 30	432,357	3/4"	150	50	150
ABREA2035	35 (M8+M10)	32 - 36	452,397	1"	150	50	100
ABREA2040	40 (M8+M10)	36 - 42	487,570	1 1/4"	150	25	100
ABREA2048	48 (M8+M10)	47 - 50	514,040	1 1/2"	150	25	100
ABREA2054	54 (M8+M10)	51 - 55	542,877	-	150	25	75
ABREA2060	60 (M8+M10)	60 - 64	577,370	2"	150	25	75
ABREA2075	75 (M8+M10)	75 - 80	642,317	2 1/2"	150	25	50
ABREA2090	90 (M8+M10)	87 - 92	739,043	3"	150	25	-
ABREA2110	110 (M8+M10)	106 - 112	799,543	-	150	25	-
ABREA2115	115 (M8+M10)	114 - 119	834,007	4"	150	25	-
ABREA2125	125 (M8+M10)	124 - 131	894,550	4 1/2"	150	25	-
ABREA2140	140 (M8+M10)	133 - 140	988,740	5"	150	25	-
ABREA2160	160 (M8+M10)	159 - 163	1.128,423	6"	150	25	-
ABREA2200	200 (M8+M10)	199 - 212	1.574,023	-	150	25	-



VENTAJAS

Tornillos con arandela plástica para evitar su pérdida
Tuerca M8/M10
Reforzada

02
P. 247
Info
Técnica

INOXIDABLE



AB-RE A4

Inoxidable A4

CÓDIGO	MEDIDA	ØD(mm)	€/100	MEDIDA EN PULGADAS	CARGA MÁXIMA		
ABREA4018	18 (M8+M10)	15 - 18	457,357	3/8"	150	50	300
ABREA4022	22 (M8+M10)	20 - 24	469,737	1/2"	150	50	200
ABREA4028	28 (M8+M10)	26 - 30	501,680	3/4"	150	50	150
ABREA4035	35 (M8+M10)	32 - 36	554,910	1"	150	50	100
ABREA4040	40 (M8+M10)	36 - 42	578,710	1 1/4"	150	25	100
ABREA4048	48 (M8+M10)	47 - 50	643,087	1 1/2"	150	25	100
ABREA4054	54 (M8+M10)	51 - 55	670,917	-	150	25	75
ABREA4060	60 (M8+M10)	60 - 64	695,323	2"	150	25	75
ABREA4075	75 (M8+M10)	75 - 80	793,503	2 1/2"	150	25	50
ABREA4090	90 (M8+M10)	87 - 92	821,780	3"	150	25	-
ABREA4110	110 (M8+M10)	106 - 112	974,127	-	150	25	-
ABREA4115	115 (M8+M10)	114 - 119	1.045,083	4"	150	25	-
ABREA4125	125 (M8+M10)	124 - 131	1.101,010	4 1/2"	150	25	-
ABREA4140	140 (M8+M10)	133 - 140	1.340,527	5"	150	25	-
ABREA4160	160 (M8+M10)	159 - 163	1.430,610	-	150	25	-
ABREA4200	200 (M8+M10)	199 - 212	1.785,590	-	150	25	-



VENTAJAS

Tornillos con arandela plástica para evitar su pérdida
Tuerca M8/M10
Reforzada

EJEMPLOS DE APLICACIÓN



AB-RI

Abrazadera isofónica reforzada M8 + M10

AB-RI

Cincada

02 Info. Técnica
P. 246

SANEAMIENTO



EJEMPLOS DE APLICACIÓN



CÓDIGO	MEDIDA	ØD(MM)	€/100	MEDIDA EN PULGADAS	CARGA MÁXIMA		
ABRI018	18 (M8+M10)	15 - 19	125,613	3/8"	80	50	200
ABRI022	22 (M8+M10)	20 - 25	133,713	1/2"	80	50	150
ABRI028	28 (M8+M10)	26 - 30	144,080	3/4"	80	50	150
ABRI035	35 (M8+M10)	32 - 36	149,377	1"	80	50	100
ABRI040	40 (M8+M10)	38 - 43	173,103	1 1/4"	80	25	75
ABRI048	48 (M8+M10)	47 - 51	182,927	1 1/2"	80	25	75
ABRI054	54 (M8+M10)	53 - 56	196,953	-	80	25	50
ABRI060	60 (M8+M10)	60 - 64	217,680	2"	80	25	50
ABRI070	70 (M8+M10)	68 - 72	225,450	-	80	25	-
ABRI075	75 (M8+M10)	75 - 80	245,877	2 1/2"	150	25	-
ABRI083	83 (M8+M10)	81 - 86	253,950	-	150	25	-
ABRI090	90 (M8+M10)	87 - 92	279,457	3"	150	25	-
ABRI100	100 (M8+M10)	99 - 105	290,237	3 1/2"	150	25	-
ABRI110	110 (M8+M10)	107 - 112	336,883	-	150	25	-
ABRI115	115 (M8+M10)	113 - 118	357,610	4"	200	25	-
ABRI125	125 (M8+M10)	125 - 130	391,303	4 1/2"	200	25	-
ABRI133	133 (M8+M10)	132 - 137	396,493	-	200	25	-
ABRI140	140 (M8+M10)	138 - 142	445,730	5"	200	25	-
ABRI150	150 (M8+M10)	148 - 152	455,580	-	200	25	-
ABRI160	160 (M8+M10)	159 - 166	492,363	6"	200	25	-
ABRI180	180 (M8+M10)	179 - 184	505,370	-	200	25	-
ABRI200	200 (M8+M10)	199 - 212	559,747	-	200	25	-
ABRI220	220 (M8+M10)	215 - 226	642,673	8"	200	25	-
ABRI250	250 (M8+M10)	245 - 254	708,340	-	200	25	-
ABRI280	280 (M8+M10)	278 - 284	772,350	-	200	25	-
ABRI300	300 (M8+M10)	299 - 304	822,193	-	200	25	-
ABRI315	315 (M8+M10)	314 - 319	915,393	-	200	25	-
ABRI355	355 (M8+M10)	354 - 359	1.287,527	-	200	25	-

VENTAJAS

Tornillos con arandela plástica para evitar su pérdida

Reforzada

Isofónica

De acuerdo al CTE

Bolsa autoservicio

CÓDIGO	MEDIDA	€/BOLSA	PCS	BOLSAS
LSABRIT022	22 (M8+M10)	5,111	2	5
LSABRIT028	28 (M8+M10)	5,257	2	5
LSABRIT035	35 (M8+M10)	5,434	2	5
LSABRIT040	40 (M8+M10)	5,434	2	5
LSABRIT048	48 (M8+M10)	5,634	2	5
LSABRIT060	60 (M8+M10)	6,023	2	5
LSABRIT075	75 (M8+M10)	6,495	2	5
LSABRIT090	90 (M8+M10)	7,464	2	5
LSABRIT110	110 (M8+M10)	8,746	2	4

KIT AB-RI + ES-DR + T4S



AB-RI V

Cincada. Ventilación

SANEAMIENTO



CÓDIGO	MEDIDA	ØD(mm)	€/100	MEDIDA EN PULGADAS	CARGA MÁXIMA	
ABRI400	400 (M8+M10)	399 - 404	1.397,460	-	200	25
ABRI450	450 (M8+M10)	449 - 454	1.682,890	-	200	10
ABRI500	500 (M8+M10)	499 - 504	1.727,080	-	200	10
ABRI560	560 (M8+M10)	555 - 561	1.916,793	-	200	10
ABRI600	600 (M8+M10)	599 - 604	2.114,103	-	200	10
ABRI630	630 (M8+M10)	625 - 631	2.295,487	-	200	10
ABRI710	710 (M8+M10)	705 - 711	2.660,003	-	200	10
ABRI800	800 (M8+M10)	799 - 804	2.890,420	-	200	10
ABRI900	900 (M8+M10)	899 - 904	3.281,037	-	200	10
ABRI910	1000 (M8+M10)	999 - 1.004	3.740,103	-	200	10
ABRI911	1120 (M8+M10)	1.115 - 1.121	4.131,877	-	200	10
ABRI912	1250 (M8+M10)	1.245 - 1.251	4.522,480	-	200	10

Abrazadera isofónica reforzada M8 + M10

AB-RI



02 Info
P. 267 Técnica

INOXIDABLE



AB-RI A2

Inoxidable A2

CÓDIGO	MEDIDA	ØD(mm)	€/100	MEDIDA EN PULGADAS	CARGA MÁXIMA		
ABRIA2018	18 (M8+M10)	15 - 18	461,010	3/8"	150	50	200
ABRIA2022	22 (M8+M10)	20 - 24	473,730	1/2"	150	50	150
ABRIA2028	28 (M8+M10)	26 - 30	494,807	3/4"	150	50	150
ABRIA2035	35 (M8+M10)	32 - 36	520,583	1"	150	50	100
ABRIA2040	40 (M8+M10)	36 - 42	575,100	1 1/4"	150	25	75
ABRIA2048	48 (M8+M10)	47 - 50	609,513	1 1/2"	150	25	75
ABRIA2054	54 (M8+M10)	51 - 55	653,360	-	150	25	50
ABRIA2060	60 (M8+M10)	60 - 64	688,830	2"	150	25	50
ABRIA2075	75 (M8+M10)	75 - 80	776,020	2 1/2"	150	25	-
ABRIA2090	90 (M8+M10)	87 - 92	815,723	3"	150	25	-
ABRIA2110	110 (M8+M10)	106 - 112	950,280	-	150	25	-
ABRIA2115	115 (M8+M10)	114 - 119	932,223	4"	150	25	-
ABRIA2125	125 (M8+M10)	124 - 131	1.033,450	4 1/2"	150	25	-
ABRIA2140	140 (M8+M10)	133 - 140	1.089,807	5"	150	25	-
ABRIA2160	160 (M8+M10)	159 - 163	1.222,713	6"	150	25	-



VENTAJAS

Tornillos con arandela plástica para evitar su pérdida
Tuerca M8/M10
Reforzada



02 Info
P. 267 Técnica

INOXIDABLE



AB-RI A4

Inoxidable A4

CÓDIGO	MEDIDA	ØD(mm)	€/100	MEDIDA EN PULGADAS	CARGA MÁXIMA		
ABRIA4018	18 (M8+M10)	15 - 18	572,757	3/8"	150	50	200
ABRIA4022	22 (M8+M10)	20 - 24	602,137	1/2"	150	50	150
ABRIA4028	28 (M8+M10)	26 - 30	628,520	3/4"	150	50	150
ABRIA4035	35 (M8+M10)	32 - 36	675,587	1"	150	50	100
ABRIA4040	40 (M8+M10)	36 - 42	728,183	1 1/4"	150	25	75
ABRIA4048	48 (M8+M10)	47 - 50	782,880	1 1/2"	150	25	75
ABRIA4054	54 (M8+M10)	51 - 55	821,610	-	150	25	50
ABRIA4060	60 (M8+M10)	60 - 64	898,087	2"	150	25	50
ABRIA4075	75 (M8+M10)	75 - 80	982,603	2 1/2"	150	25	-
ABRIA4090	90 (M8+M10)	87 - 92	1.078,133	3"	150	25	-
ABRIA4110	110 (M8+M10)	106 - 112	1.271,167	-	150	25	-
ABRIA4115	115 (M8+M10)	114 - 119	1.321,527	4"	150	25	-
ABRIA4125	125 (M8+M10)	124 - 131	1.400,003	4 1/2"	150	25	-
ABRIA4140	140 (M8+M10)	133 - 140	1.449,203	5"	150	25	-
ABRIA4160	160 (M8+M10)	159 - 163	1.739,243	6"	150	25	-



VENTAJAS

Tornillos con arandela plástica para evitar su pérdida
Tuerca M8/M10
Reforzada

EJEMPLOS DE APLICACIÓN



AB-RI DES

Abrazadera isofónica reforzada deslizante M8+M10



VENTAJAS

Apertura lateral

Coma más dura para permitir el movimiento deslizante en la tubería

Discos de plástico para ajustar al diámetro adecuado de tubería

CÓDIGO	MEDIDA	€/100	
ABRID016	16	196,230	150
ABRID020	20	204,403	100
ABRID025	25	216,667	100
ABRID032	32	237,110	100
ABRID040	40	257,547	50
ABRID050	50	329,090	50
ABRID063	63	412,893	50
ABRID075	75	470,127	50
ABRID090	90	519,183	50
ABRID110	110	674,533	25
ABRID125	125	817,613	25
ABRID140	140	866,670	20
ABRID160	160	1.001,577	20

PA-EX

Patín de expansión



CÓDIGO	MEDIDA	€/100	
PAEXM08	M8 x 180	3.579,107	50
PAEXM10	M10 x 180	3.579,107	50

CO-AR

Colgador articulado



CÓDIGO	MEDIDA	€/100		
COAR08060	M8 x 60	246,183	50	300
COAR10060	M10 x 60	378,743	50	300

AB-ICP

Abrazadera isofónica reforzada para cargas pesadas



VENTAJAS

Reforzada

Con manguitos disponibles desde M8 hasta M16 dependiendo del diámetro

Espesor de 3-4 mm

CÓDIGO	MEDIDA	ØD(mm)	€/100	
ABICP060	60 (M8+M10)	60 - 64	971,703	25
ABICP075	75 (M10+M12)	75 - 80	1.187,637	25
ABICP090	90 (M10+M12)	87 - 92	1.295,600	25
ABICP110	110 (M10+M12)	107 - 112	1.484,547	25
ABICP140	140 (M12+M16)	138 - 142	2.591,210	25
ABICP160	160 (M12+M16)	159 - 166	3.077,057	25
ABICP220	220 (M12+M16)	215 - 226	4.048,763	10
ABICP270	270 (M12+M16)	268 - 274	5.072,760	10
ABICP315	315 (M12+M16)	314 - 319	5.752,613	10

Abrazadera aislante térmica

AB-AIS



AB-AIS 13

13 mm

CÓDIGO	MEDIDA	€/100	ESPEJOR AISLANTE (MM)	
ABAI513010	Ø10	852,977	13	50
ABAI513012	Ø12	874,847	13	50
ABAI513015	Ø15	896,717	13	50
ABAI513018	Ø18	962,333	13	50
ABAI513022	Ø22	1.027,947	13	50
ABAI513028	Ø28	1.071,687	13	50



AB-AIS 19

19 mm

CÓDIGO	MEDIDA	€/100	ESPEJOR AISLANTE (MM)	
ABAI519010	Ø10	1.049,817	19	50
ABAI519012	Ø12	1.071,687	19	50
ABAI519015	Ø15	1.137,303	19	50
ABAI519017	Ø17	1.137,303	19	50
ABAI519018	Ø18	1.159,170	19	50
ABAI519022	Ø22	1.181,040	19	50
ABAI519028	Ø28	1.268,527	19	50
ABAI519035	Ø35	1.356,010	19	50
ABAI519042	Ø42	1.465,370	19	25
ABAI519054	Ø54	1.662,213	19	25
ABAI519060	Ø60	1.837,180	19	25
ABAI519064	Ø64	2.012,150	19	25
ABAI519067	Ø67	2.143,377	19	25
ABAI519076	Ø76	2.296,473	19	25
ABAI519080	Ø80	2.405,827	19	25
ABAI519114	Ø114	3.280,673	19	10



AB-AIS 30

30 mm

CÓDIGO	MEDIDA	€/100	ESPEJOR AISLANTE (MM)	
ABAI530027	Ø27	1.596,597	30	50
ABAI530034	Ø34	1.727,823	30	50
ABAI530042	Ø42	1.837,180	30	25
ABAI530049	Ø49	1.902,793	30	25
ABAI530054	Ø54	2.296,473	30	25
ABAI530060	Ø60	2.340,220	30	25
ABAI530076	Ø76	2.449,573	30	25
ABAI530089	Ø89	2.602,667	30	25
ABAI530108	Ø108	3.608,743	30	10
ABAI530114	Ø114	3.718,100	30	10



AB-AIS 40

40 mm

CÓDIGO	MEDIDA	€/100	ESPEJOR AISLANTE (MM)	
ABAI540049	Ø49	2.383,957	40	25
ABAI540060	Ø60	2.799,510	40	25
ABAI540089	Ø89	3.368,160	40	25
ABAI540114	Ø114	5.249,080	40	10
ABAI540133	Ø133	5.664,637	40	10
ABAI540140	Ø140	6.123,927	40	10
ABAI540159	Ø159	6.998,777	40	10
ABAI540168	Ø168	7.436,200	40	10
ABAI540219	Ø219	8.967,180	40	5



AB-GA

Abrazadera gásmica M8 + M10 amarilla

02 Info. Técnica
P. 248

SANEAMIENTO



VENTAJAS

Tornillos con arandela plástica para evitar su pérdida
Reforzada

CÓDIGO	MEDIDA	ØD(mm)	€/100	MEDIDA EN PULGADAS	CARGA MÁXIMA		
ABGA018	18 (M8)	15 - 18	101,093	3/8"	200	50	300
ABGA022	22 (M8)	20 - 24	106,563	1/2"	200	50	200
ABGA028	28 (M8)	26 - 30	113,300	3/4"	200	50	150
ABGA035	35 (M8)	32 - 36	121,470	1"	200	50	100
ABGA040	40 (M8)	38 - 42	127,777	1 1/4"	200	50	100
ABGA048	48 (M8)	47 - 50	134,237	1 1/2"	200	50	100
ABGA054	54 (M8)	52 - 56	142,940	-	200	25	75
ABGA060	60 (M8/M10)	60 - 64	152,947	2"	200	25	75
ABGA075	75 (M8/M10)	75 - 80	182,777	2 1/2"	200	25	50
ABGA090	90 (M8/M10)	85 - 90	193,153	3"	200	25	-
ABGA100	100 (M8/M10)	99 - 105	212,240	3 1/2"	200	25	-
ABGA110	110 (M8/M10)	107 - 112	240,363	-	200	25	-
ABGA115	115 (M8/M10)	113 - 118	243,627	4"	200	25	-
ABGA140	140 (M8/M10)	138 - 142	285,920	5"	200	25	-
ABGA160	160 (M8/M10)	159 - 166	301,690	6"	200	25	-

Bolsa autoservicio

CÓDIGO	MEDIDA	€/BOLSA	PCS	BOLSAS
LSABGAT022	22 (M8)	4,870	2	6
LSABGAT028	28 (M8)	4,970	2	6
LSABGAT035	35 (M8)	4,890	2	6
LSABGAT040	40 (M8)	5,263	2	6
LSABGAT048	48 (M8)	5,167	2	6
LSABGAT060	60 (M8/M10)	5,527	2	6
LSABGAT075	75 (M8/M10)	5,920	2	6
LSABGAT090	90 (M8/M10)	6,487	2	6
LSABGAT110	110 (M8/M10)	8,770	2	5

KIT
AB-GA + ES-DR + T4S



EJEMPLOS DE APLICACIÓN



AB-M8

Abrazadera desagüe M8

02 Info. Técnica
P. 248

SANEAMIENTO



VENTAJAS

Tuercas laterales remachadas
Tuercas M8 remachada

CÓDIGO	MEDIDA	ØD(mm)	€/100	CARGA MÁXIMA	
ABM8050	50 (M8)	49 - 54	139,290	100	100
ABM8063	63 (M8)	60 - 65	136,806	100	100
ABM8075	75 (M8)	75 - 80	147,234	100	100
ABM8090	90 (M8)	88 - 92	157,458	100	100
ABM8110	110 (M8)	108 - 113	174,114	100	100
ABM8125	125 (M8)	124 - 130	182,631	100	100
ABM8160	160 (M8)	159 - 165	239,053	100	100
ABM8200	200 (M8)	199 - 203	283,823	100	100
ABM8250	250 (M8)	249 - 254	362,733	100	50
ABM8315	315 (M8)	314 - 319	786,517	100	50

Bolsa autoservicio

CÓDIGO	MEDIDA	€/BOLSA	PCS	BOLSAS
LSABM8090	90 (M8)	3,930	2	6
LSABM8110	110 (M8)	4,101	2	6
LSABM8125	125 (M8)	2,803	1	8
LSABM8160	160 (M8)	3,607	1	4



Abrazadera desagüe de empotrar

AB-DE

02 Info
Técnica
P. 249

SANEAMIENTO



CÓDIGO	MEDIDA	ØD(mm)	€/100	CARGA MÁXIMA	
ABDE075	75	75 - 80	232,780	200	100
ABDE090	90	87 - 92	252,020	200	100
ABDE110	110	107 - 112	304,520	200	100
ABDE125	125	125 - 130	343,027	200	50

AB-DE Z

Cincada



02 Info
Técnica
P. 249

SANEAMIENTO



CÓDIGO	MEDIDA	ØD(mm)	€/100	CARGA MÁXIMA	
ABDE160	160	159 - 166	399,027	200	50
ABDE200	200	199 - 212	479,533	200	50
ABDE250	250	245 - 254	770,053	200	25
ABDE315	315	314 - 319	966,073	200	25

AB-DE G

Recubrimiento ATLANTIS C2-L



EJEMPLOS DE APLICACIÓN



VENTAJAS

Diseñada para ser empotrada en obra
Tuercas sueltas para facilitar montaje
Reforzada (2,5 mm)

Abrazadera desagüe con pie

AB-DP

02 Info
Técnica
P. 249

SANEAMIENTO



CÓDIGO	MEDIDA	ØD(mm)	€/100	CARGA MÁXIMA	
ABDP075	75	75 - 80	266,023	200	100
ABDP090	90	87 - 92	290,523	200	100
ABDP110	110	107 - 112	317,820	200	100
ABDP125	125	125 - 130	357,027	200	50

AB-DP Z

Cincada



02 Info
Técnica
P. 249

SANEAMIENTO



CÓDIGO	MEDIDA	ØD(mm)	€/100	CARGA MÁXIMA	
ABDP160	160	159 - 166	427,030	200	50
ABDP200	200	199 - 212	504,037	200	25
ABDP250	250	245 - 254	700,057	200	25

AB-DP G

Recubrimiento ATLANTIS C2-L



EJEMPLOS DE APLICACIÓN



VENTAJAS

Diseñada para ser fijada en la pared
Tuercas sueltas para facilitar montaje
Reforzada

AB-ZI

Abarcón

AB-ZI

Cincada

02
P. 250
Info.
Técnica

SANEAMIENTO



VENTAJAS

Medidas M6 - M8 - M10
Montado con 4 tuercas
Fijación rápida y resistente

CÓDIGO	MEDIDA	€/100	CARGA MÁXIMA	Ø VARILLA PULGADAS		
AZIM060250	M6 1/4"	29,187	250	1/4"	100	800
AZIM060375	M6 3/8"	30,207	250	3/8"	100	1.200
AZIM060500	M6 1/2"	34,667	250	1/2"	100	600
AZIM060750	M6 3/4"	41,020	250	3/4"	100	600
AZIM061000	M6 1"	44,057	250	1"	100	400
AZIM061250	M6 1 1/4"	58,933	250	1 1/4"	50	300
AZIM081500	M8 1 1/2"	91,487	350	1 1/2"	50	150
AZIM082000	M8 2"	104,280	350	2"	50	150
AZIM082250	M8 2 1/4"	121,447	350	2 1/4"	50	100
AZIM082500	M8 2 1/2"	127,977	350	2 1/2"	50	100
AZIM083000	M8 3"	137,223	350	3"	50	100
AZIM083500	M8 3 1/2"	163,463	350	3 1/2"	50	100
AZIM084000	M8 4"	201,750	350	4"	50	100
AZIM084500	M8 4 1/2"	213,380	350	4 1/2"	25	100
AZIM085000	M8 5"	220,847	350	5"	25	100
AZIM086000	M8 6"	251,080	350	6"	25	100
AZIM103000	M10 3"	195,150	350	3"	25	50
AZIM103500	M10 3 1/2"	224,053	350	3 1/2"	25	50
AZIM104000	M10 4"	251,677	350	4"	25	100
AZIM105000	M10 5"	279,050	350	5"	25	100
AZIM106000	M10 6"	322,783	350	6"	25	100
AZIM108000	M10 8"	367,283	350	8"	25	100

AB-ZI A2

Inoxidable A2

SANEAMIENTO



CÓDIGO	MEDIDA	€/100	CARGA MÁXIMA		
AZA2060500	M6 1/2"	114,353	250	100	600
AZA2060750	M6 3/4"	132,940	250	100	600
AZA2061000	M6 1"	163,783	250	100	400
AZA2061250	M6 1 1/4"	193,923	250	50	300
AZA2081500	M8 1 1/2"	337,000	350	50	150
AZA2082000	M8 2"	391,970	350	50	150
AZA2082500	M8 2 1/2"	441,640	350	50	100
AZA2083000	M8 3"	480,030	350	50	100
AZA2104000	M10 4"	976,667	350	50	-
AZA2106000	M10 6"	1.259,620	350	25	-
AZA2108000	M10 8"	1.506,923	350	25	-

Soporte de abarcón

AB-SA

02 Info
P. 250 Técnica

SANEAMIENTO



CÓDIGO	MEDIDA	€/100	LONGITUD	
ABSA050100	50 x 100	520,587	100	50
ABSA050125	50 x 125	564,197	125	50
ABSA050200	50 x 200	689,717	200	25
ABSA050300	50 x 300	834,070	300	25
ABSA050400	50 x 400	1.019,010	400	25
ABSA050500	50 x 500	1.488,703	500	10
ABSA050600	50 x 600	1.634,130	600	10
ABSA100100	100 x 100	691,573	100	25
ABSA100125	100 x 125	741,897	125	25
ABSA100200	100 x 200	876,913	200	25
ABSA100300	100 x 300	1.112,117	300	10
ABSA100400	100 x 400	1.487,533	400	10
ABSA100500	100 x 500	1.944,410	500	10



VENTAJAS

Espesor 5 y 6 mm.
Abarcón M8 - Arandela DIN9021
Abarcón M10 - Arandelas DIN125 & 9021
Altura 50 & 100 mm.



Abrazadera de gran presión

AB-GP

02 Info
P. 251 Técnica

SANEAMIENTO



CÓDIGO	MEDIDA	ØD(mm)	€/100		
AGP023025	23-25	23 - 25	154,553	50	300
AGP026028	26-28	26 - 28	160,700	50	300
AGP029031	29-31	29 - 31	193,123	50	200
AGP032035	32-35	32 - 35	198,397	50	150
AGP036039	36-39	36 - 39	199,723	50	150
AGP040043	40-43	40 - 43	211,593	50	100
AGP044047	44-47	44 - 47	277,400	50	-
AGP048051	48-51	48 - 51	289,557	25	75
AGP052055	52-55	52 - 55	295,953	25	75
AGP056059	56-59	56 - 59	302,983	25	75
AGP060063	60-63	60 - 63	315,783	25	50
AGP064067	64-67	64 - 67	346,043	25	50
AGP068073	68-73	68 - 73	426,273	25	-
AGP074079	74-79	74 - 79	431,553	25	-
AGP080085	80-85	80 - 85	436,037	25	-
AGP086091	86-91	86 - 91	444,310	25	-
AGP092097	92-97	92 - 97	465,867	25	-
AGP098103	98-103	98 - 103	470,700	25	-
AGP104112	104-112	104 - 112	511,177	25	-
AGP113121	113-121	113 - 121	545,927	25	-
AGP122130	122-130	122 - 130	585,960	25	-
AGP131139	131-139	131 - 139	731,127	25	-
AGP140148	140-148	140 - 148	746,963	25	-
AGP149161	149-161	149 - 161	791,403	25	-
AGP162174	162-174	162 - 174	826,147	25	-



EJEMPLOS DE APLICACIÓN



VENTAJAS

Fleje redondeado para no dañar el tubo
Gran capacidad de apriete
Tornillo calidad 8.8





















Blíster



























CÓDIGO	MEDIDA	€/BOLSA	PCS	BOLSAS
BZAGP023025	23-25	4,649	2	10
BZAGP029031	29-31	4,649	2	10
BZAGP040043	40-43	4,649	2	10



ABRAZADERAS METÁLICAS LIGERAS



MEDIDAS (mm)	CARGA RECOMENDADA kg	RECUBRIMIENTO	ESPESOR (mm)	ANCHURA (mm)	APERTURA	MANGUITO	HOMOLOGACIÓN	ISOFÓNICA	CTE	MONTAJE EN PARALELO	TORNILLO
AB-M6 APLICACIONES: Gas, Saneamiento, Eléctrico P. 54											
AB-M6 Z											
	Ø 8 - Ø 63	70 - 100	 AB-M6 AB-M6 Z	1 - 1,2	12	Rápida lateral	Embutida M6	-	-	-	-
AB-M7 Z APLICACIONES: Gas Saneamiento Eléctrico P. 57											
	Ø 8 - Ø 63	70	 ZINC	0,8 - 1	11	-	Embutida M7	-	-	-	-
AB-D6 APLICACIONES: Gas, Saneamiento, Eléctrico P. 55											
AB-D6 Z											
	Ø 12 - Ø 28	100	 AB-D6 AB-D6 Z	1	12	-	Embutida M6	-	-	✓	-
AB-DZ 7 APLICACIONES: Gas, Saneamiento, Eléctrico P. 57											
	Ø 10 - Ø 28	70	 ZINC	0,8 - 1	11	-	Embutida M7	-	-	✓	-
AB-6I APLICACIONES: ACS y AF, Gas, Saneamiento, Calefacción, Climatización, Eléctrico, Ventilación P. 56											
	Ø 12 - Ø 60	70 - 100	 YELLOW	1 - 1,2	12	Rápida lateral	Embutida M6	-	✓	✓	-
AB-DI APLICACIONES: ACS y AF, Gas, Saneamiento, Calefacción, Climatización, Eléctrico, Ventilación P. 56											
	Ø 12 - Ø 60	100	 YELLOW	1	12	-	Embutida M6	-	✓	✓	✓
AB-7I Z APLICACIONES: ACS y AF, Gas, Saneamiento, Calefacción, Climatización, Eléctrico, Ventilación P. 58											
	Ø 12 - Ø 50	70	 ZINC	0,8 - 1	11	-	Embutida M7	-	✓	✓	-
AB-7ID Z APLICACIONES: ACS y AF, Gas, Saneamiento, Calefacción, Climatización, Eléctrico, Ventilación P. 58											
	Ø 10 - Ø 28	70	 ZINC	0,8 - 1	11	-	Embutida M7	-	✓	✓	✓
AB-PI APLICACIONES: Saneamiento, Eléctrico P. 59											
	Ø 6 - Ø 63	30	 ZINC	1,1 - 1,3	12,5 - 19	-	-	-	-	-	-
AB-PU APLICACIONES: Saneamiento, Eléctrico P. 59											
	Ø 16 - Ø 63	30	 ZINC	1,2 - 1,4	12 - 20	-	-	-	-	-	-

MEDIDAS (mm)	CARGA RECOMENDADA kg	RECUBRIMIENTO	ESPESOR (mm)	ANCHURA (mm)	APERTURA	MANGUITO	HOMOLOGACIÓN	ISOFÓNICA	CTE <small>Clase de eficiencia energética</small>	MONTAJE EN PARALELO	TORNILLO	
AB-GM APLICACIONES: Gas P. 64												
	Ø 12 - Ø 35	100		1 - 1,2	12	Rápida lateral	Embutida M6	De acuerdo a UNE-EN ISO 4892	-	-	-	Premontado
AB-GS APLICACIONES: Gas P. 65												
	Ø 10 - Ø 54	70 - 100		1 - 1,2	12	Rápida lateral	Embutida M6	De acuerdo a UNE-EN ISO 4892	-	-	-	Premontado
AB-GD APLICACIONES: Gas P. 65												
	Ø 12 - Ø 28	100		1 - 1,2	12	-	Embutida M6	De acuerdo a UNE-EN ISO 4892	-	-		Premontado
AB-CR APLICACIONES: Saneamiento P. 63												
	Ø 10 - Ø 12	70		1 - 1,2	12	Rápida lateral	Embutida M6	-	-	-	-	-
AB-ITS P. 63												
	15 - 28	-		1,0 - 1,2	20 - 33	-	-	-	-	-	-	-
AB-ITD P. 63												
	15 - 22	-		1,0	20 - 27	-	-	-	-	-	-	-
AB-BU APLICACIONES: Saneamiento, Industrial P. 64												
	Ø 13 - Ø 21	-		0,6	9	-	-	-	-	-	-	Premontado
AB-SF APLICACIONES: Saneamiento, Industrial P. 61												
	Ø 8 - Ø 150	-		0,6 - 0,8	9	-	-	-	-	-	-	Premontado
AB-IP APLICACIONES: ACS y AF, Gas, Saneamiento, Calefacción, Climatización, Eléctrico, Ventilación P. 60												
	-	-		1,5	20	-	-	-			-	ABT006015
AB-SI APLICACIONES: ACS y AF, Gas, Saneamiento, Calefacción, Climatización, Eléctrico, Ventilación P. 60												
	3 / 25 Agujeros	-		3	20	-	-	-				ABT006015

AB-M6

Abrazadera M6

AB-M6

Bicromatada



VENTAJAS

Instalación rápida
Apertura lateral
Tuerca M6 embutida



SANEAMIENTO



CÓDIGO	MEDIDA	ØD(mm)	€/100	MEDIDA EN PULGADAS	CARGA MÁXIMA		
ABM6008	8 (M6)	8	19,160	-	70	100	1.200
ABM6010	10 (M6)	10	19,840	1/8"	70	100	1.200
ABM6012	12 (M6)	12	19,600	-	70	100	1.200
ABM6014	14 (M6)	14	20,283	1/4"	70	100	1.200
ABM6015	15 (M6)	15	20,290	-	70	100	600
ABM6016	16 (M6)	16	20,860	-	70	100	600
ABM6018	18 (M6)	18	21,367	3/8"	70	100	600
ABM6020	20 (M6)	20	21,690	-	70	100	600
ABM6022	22 (M6)	22	22,670	1/2"	70	100	600
ABM6025	25 (M6)	25	23,813	-	70	100	600
ABM6026	26 (M6)	26	25,047	3/4"	70	100	400
ABM6028	28 (M6)	28	25,650	-	70	100	400
ABM6032	32 (M6)	32	28,403	1"	70	50	300
ABM6035	35 (M6)	35	31,927	-	70	50	300
ABM6037	37 (M6)	37	33,337	-	100	50	300
ABM6040	40 (M6)	40	36,203	-	100	50	300
ABM6042	42 (M6)	42	37,550	1 1/4"	100	50	300
ABM6047	47 (M6)	47	40,830	1 1/2"	100	50	200
ABM6050	50 (M6)	50	40,997	-	100	50	150
ABM6054	54 (M6)	54	47,667	-	100	50	150
ABM6060	60 (M6)	60	52,170	2"	100	50	150
ABM6063	63 (M6)	63	55,090	-	100	50	100

Bolsa autoservicio

CÓDIGO	MEDIDA	€/BOLSA	PCS	BOLSAS
LSABM6012	12 (M6)	6,001	20	5
LSABM6014	14 (M6)	6,117	20	5
LSABM6016	16 (M6)	6,227	20	5
LSABM6018	18 (M6)	5,199	15	6
LSABM6022	22 (M6)	4,342	10	6
LSABM6028	28 (M6)	3,165	6	6
LSABM6032	32 (M6)	2,813	4	6
LSABM6040	40 (M6)	3,230	4	5

AB-M6 Z

Cincada



VENTAJAS

Instalación rápida
Apertura lateral
Tuerca M6 embutida



SANEAMIENTO



CÓDIGO	MEDIDA	ØD(mm)	€/100	MEDIDA EN PULGADAS	CARGA MÁXIMA		
ABMZ6008	8 (M6)	8	19,160	-	70	100	1.200
ABMZ6010	10 (M6)	10	19,840	1/8"	70	100	1.200
ABMZ6012	12 (M6)	12	19,600	-	70	100	1.200
ABMZ6014	14 (M6)	14	20,283	1/4"	70	100	1.200
ABMZ6015	15 (M6)	15	20,667	-	70	100	600
ABMZ6016	16 (M6)	16	20,860	-	70	100	600
ABMZ6018	18 (M6)	18	21,367	3/8"	70	100	600
ABMZ6020	20 (M6)	20	21,690	-	70	100	600
ABMZ6022	22 (M6)	22	22,670	1/2"	70	100	600
ABMZ6025	25 (M6)	25	23,813	-	70	100	600
ABMZ6026	26 (M6)	26	25,047	3/4"	70	100	400
ABMZ6028	28 (M6)	28	25,650	-	70	100	400
ABMZ6032	32 (M6)	32	28,403	1"	70	50	300
ABMZ6035	35 (M6)	35	31,927	-	70	50	300
ABMZ6037	37 (M6)	37	33,963	-	100	50	300
ABMZ6040	40 (M6)	40	36,203	-	100	50	300
ABMZ6042	42 (M6)	42	37,550	1 1/4"	100	50	300
ABMZ6047	47 (M6)	47	40,830	1 1/2"	100	50	200
ABMZ6050	50 (M6)	50	40,997	-	100	50	150
ABMZ6054	54 (M6)	54	47,667	-	100	50	150
ABMZ6060	60 (M6)	60	52,170	2"	100	50	150
ABMZ6063	63 (M6)	63	55,090	-	100	50	100

Abrazadera M6

AB-M6

 Info Técnica
p. 252

INOXIDABLE



AB-M6 A2

Inoxidable A2



VENTAJAS
Tuerca soldada M6
Espesor 1,5 mm.

CÓDIGO	MEDIDA	ØD(mm)	€/100	MEDIDA EN PULGADAS	CARGA MÁXIMA		
ABM6A2012	12 (M6)	12	257,013	1/4"	70	100	1.200
ABM6A2015	15 (M6)	14 - 15	261,657	-	70	100	600
ABM6A2018	18 (M6)	16 - 18	266,300	3/8"	70	100	600
ABM6A2020	20 (M6)	19 - 21	271,627	1/2"	70	100	600
ABM6A2022	22 (M6)	22 - 24	275,067	-	70	100	600
ABM6A2028	28 (M6)	25 - 30	290,510	3/4"	70	100	400

Abrazadera doble M6

AB-D6

 Info Técnica
p. 252

SANEAMIENTO





AB-D6



Bicromatada



VENTAJAS
Para montajes en paralelo
Tuerca M6 embutida

CÓDIGO	MEDIDA	ØD(mm)	€/100	MEDIDA EN PULGADAS	CARGA MÁXIMA		
ABD6012	12 (M6)	12	30,527	-	100	50	600
ABD6015	15 (M6)	15	33,257	-	100	50	300
ABD6018	18 (M6)	18	36,533	3/8"	100	50	300
ABD6022	22 (M6)	22	41,433	1/2"	100	50	300
ABD6028	28 (M6)	28	48,560	-	100	50	200

 Bolsa autoservicio

CÓDIGO	MEDIDA	€/BOLSA	PCS 	BOLSAS 
LSABD6012	12 (M6)	3,237	5	6
LSABD6015	15 (M6)	3,343	5	6
LSABD6018	18 (M6)	3,437	5	6
LSABD6022	22 (M6)	3,343	4	6
LSABD6028	28 (M6)	4,110	4	6

 Info Técnica
p. 252

SANEAMIENTO



AB-D6 Z

Cincada



VENTAJAS
Para montajes en paralelo
Tuerca M6 embutida

CÓDIGO	MEDIDA	ØD(mm)	€/100	MEDIDA EN PULGADAS	CARGA MÁXIMA		
ABDZ6012	12 (M6)	12	30,527	-	100	50	600
ABDZ6015	15 (M6)	15	33,257	-	100	50	300
ABDZ6018	18 (M6)	18	36,533	3/8"	100	50	300
ABDZ6022	22 (M6)	22	41,433	1/2"	100	50	300
ABDZ6028	28 (M6)	28	48,560	-	100	50	200

EJEMPLOS DE APLICACIÓN



AB-6I

Abrazadera isofónica M6

02 Info. Técnica
P. 253

SANEAMIENTO



VENTAJAS

Instalación rápida
Tuerca M6 embutida
De acuerdo al CTE

CÓDIGO	MEDIDA	ØD(mm)	€/100	MEDIDA EN PULGADAS	CARGA MÁXIMA		
AB6I012	12 (M6)	12	29,650	1/8"	70	100	600
AB6I015	15 (M6)	15	30,477	1/4"	70	100	600
AB6I016	16 (M6)	16	31,830	-	70	100	600
AB6I018	18 (M6)	18	32,107	3/8"	70	100	600
AB6I022	22 (M6)	22	36,533	1/2"	70	100	400
AB6I026	26 (M6)	26	41,410	-	70	100	400
AB6I028	28 (M6)	28	43,080	3/4"	70	100	300
AB6I032	32 (M6)	32	45,107	-	70	50	200
AB6I035	35 (M6)	35	50,863	1"	70	50	200
AB6I042	42 (M6)	42	62,887	1 1/4"	100	50	150
AB6I048	48 (M6)	48	71,190	1 1/2"	100	50	100
AB6I054	54 (M6)	54	84,083	-	100	50	100
AB6I060	60 (M6)	60	89,317	2"	100	50	100

Bolsa autoservicio

CÓDIGO	MEDIDA	€/BOLSA	PCS	BOLSAS
LSAB6I012	12 (M6)	4,886	10	6
LSAB6I015	15 (M6)	5,138	10	5
LSAB6I016	16 (M6)	5,167	10	6
LSAB6I018	18 (M6)	4,184	8	6
LSAB6I022	22 (M6)	3,819	6	6
LSAB6I028	28 (M6)	3,343	4	6

AB-DI

Abrazadera doble isofónica M6

02 Info. Técnica
P. 253

SANEAMIENTO



VENTAJAS

Para montajes en paralelo
Tuerca M6 embutida
De acuerdo al CTE

CÓDIGO	MEDIDA	ØD(mm)	€/100	MEDIDA EN PULGADAS	CARGA MÁXIMA		
ABDI0012	12 (M6)	12	53,167	1/8"	100	50	300
ABDI0015	15 (M6)	15	63,413	1/4"	100	50	300
ABDI0018	18 (M6)	18	69,197	3/8"	100	50	200
ABDI0022	22 (M6)	22	79,703	1/2"	100	50	200
ABDI0028	28 (M6)	28	104,017	3/4"	100	50	150

Bolsa autoservicio

CÓDIGO	MEDIDA	€/BOLSA	PCS	BOLSAS
LSABDI0012	12 (M6)	3,851	5	6
LSABDI0015	15 (M6)	4,068	5	6
LSABDI0018	18 (M6)	3,311	3	6
LSABDI0022	22 (M6)	3,460	3	6



Abrazadera M7. Cincada

AB-M7 Z

02
P. 254
Info
Técnica

SANEAMIENTO



CÓDIGO	MEDIDA	ØD(mm)	€/100		
ABMZ7008	8	8	19,160	100	1.200
ABMZ7010	10	10	19,840	100	1.200
ABMZ7012	12	12	19,600	100	1.200
ABMZ7014	14	14	20,283	100	1.200
ABMZ7016	16	16	20,860	100	1.200
ABMZ7018	18	18	21,367	100	1.200
ABMZ7020	20	20	21,687	100	1.200
ABMZ7022	22	22	22,670	100	600
ABMZ7024	24	24	23,133	100	600
ABMZ7025	25	25	23,813	100	600
ABMZ7026	26	26	25,047	100	600
ABMZ7028	28	28	25,650	100	600
ABMZ7032	32	32	28,403	50	600
ABMZ7034	34	34	31,587	50	300
ABMZ7036	36	36	33,663	50	300
ABMZ7038	38	38	33,607	50	300
ABMZ7040	40	40	36,203	50	300
ABMZ7050	50	50	40,997	50	200
ABMZ7063	63	63	55,090	25	150



VENTAJAS
 Instalación rápida
 Apertura lateral
 Tuerca M7 embutida



Abrazadera doble M7. Cincada

AB-D7 Z

02
P. 254
Info
Técnica

SANEAMIENTO



CÓDIGO	MEDIDA	ØD(mm)	€/100		
ABDZ70810	8-10	8-10	31,090	50	600
ABDZ71012	10-12	10-12	30,527	50	600
ABDZ71214	12-14	12-14	32,933	50	600
ABDZ71416	14-16	14-16	33,257	50	600
ABDZ71618	16-18	16-18	36,533	50	600
ABDZ71820	18-20	18-20	41,433	50	300
ABDZ72022	20-22	20-22	48,560	50	300
ABDZ72224	22-24	22-24	50,150	50	300
ABDZ72628	26-28	26-28	52,697	50	300



VENTAJAS
 Para montajes en paralelo
 Tuerca M7 embutida

AB-7I Z

Abrazadera isofónica M7. Cincada



SANEAMIENTO



VENTAJAS

Instalación rápida
Tuerca M7 embutida
De acuerdo al CTE

CÓDIGO	MEDIDA	ØD(mm)	€/100		
AB7IZ010	10	10	28,257	100	1.200
AB7IZ012	12	12	29,650	100	1.200
AB7IZ014	14	14	30,477	100	1.200
AB7IZ016	16	16	31,830	100	1.200
AB7IZ018	18	18	32,107	100	600
AB7IZ020	20	20	34,643	100	600
AB7IZ022	22	22	36,533	100	600
AB7IZ024	24	24	37,713	100	600
AB7IZ026	26	26	41,410	100	600
AB7IZ028	28	28	43,080	100	400
AB7IZ032	32	32	45,107	50	300
AB7IZ034	34	34	48,597	50	300
AB7IZ036	36	36	50,863	50	300
AB7IZ038	38	38	51,147	50	300
AB7IZ040	40	40	56,807	50	300
AB7IZ050	50	50	59,227	50	200

AB-7ID Z

Abrazadera doble isofónica M7. Cincada



SANEAMIENTO



VENTAJAS

Para montajes en paralelo
Tuerca M7 embutida
De acuerdo al CTE

CÓDIGO	MEDIDA	ØD(mm)	€/100		
AB7IDZ0810	08-10	08-10	49,710	50	600
AB7IDZ1012	10-12	10-12	53,167	50	600
AB7IDZ1214	12-14	12-14	54,863	50	600
AB7IDZ1416	14-16	14-16	63,413	50	300
AB7IDZ1618	16-18	16-18	69,197	50	300
AB7IDZ1820	18-20	18-20	70,150	50	300
AB7IDZ2022	20-22	20-22	79,703	50	300
AB7IDZ2224	22-24	22-24	84,380	50	200
AB7IDZ2628	26-28	26-28	104,017	50	200



Grapa 1 pie

AB-PI

 Info Técnica
P. 256

SANEAMIENTO



CÓDIGO	MEDIDA	ØD(mm)	€/100	MEDIDA EN PULGADAS	CARGA MÁXIMA		
ABPI006	6	6	6,027	-	30	100	2.400
ABPI008	8	8	6,443	-	30	100	2.400
ABPI010	10	10	7,160	1/8"	30	100	2.400
ABPI012	12	12	7,557	1/4"	30	100	2.400
ABPI014	14	14	9,487	-	30	100	2.400
ABPI016	16	16	11,610	3/8"	30	100	1.200
ABPI018	18	18	12,600	-	30	100	1.200
ABPI020	20	20	14,980	1/2"	30	100	1.200
ABPI022	22	22	16,373	-	30	100	600
ABPI025	25	25	18,260	-	30	100	600
ABPI026	26	26	18,887	3/4"	30	100	600
ABPI028	28	28	19,833	-	30	100	600
ABPI032	32	32	27,090	1"	30	100	600
ABPI040	40	40	37,137	-	30	50	300
ABPI042	42	42	43,787	1 1/4"	30	50	300
ABPI047	47	47	45,633	1 1/2"	30	50	200
ABPI050	50	50	47,197	-	30	50	200
ABPI063	63	63	70,750	2"	30	50	200



EJEMPLOS DE APLICACIÓN



 Blíster

CÓDIGO	MEDIDA	€/BOLSA	PCS BLS	BOLSAS
BZABPI016	16	2,024	2	15
BZABPI018	18	2,024	2	12
BZABPI020	20	2,024	2	10
BZABPI022	22	2,024	2	10
BZABPI025	25	2,024	2	10
BZABPI028	28	2,024	2	10
BZABPI032	32	2,024	2	10

 Bolsa autoservicio

CÓDIGO	MEDIDA	€/BOLSA	PCS BLS	BOLSAS
LSABPI016	16	4,462	20	5
LSABPI018	18	4,585	20	5
LSABPI020	20	4,766	20	5
LSABPI022	22	5,219	20	5
LSABPI025	25	4,775	15	5
LSABPI028	28	4,034	10	6
LSABPI032	32	3,344	6	6
LSABPI040	40	3,170	4	6

VENTAJAS

Con refuerzo
Fijación rápida
Un solo punto de fijación



Grapa puente

AB-PU

 Info Técnica
P. 256

SANEAMIENTO



CÓDIGO	MEDIDA	ØD(mm)	€/100	MEDIDA EN PULGADAS	CARGA MÁXIMA		
ABPU016	16	16	14,620	3/8"	75	100	1.200
ABPU018	18	18	15,313	-	75	100	1.200
ABPU020	20	20	15,487	1/2"	75	100	600
ABPU022	22	22	18,693	-	75	100	600
ABPU025	25	25	19,703	-	75	100	600
ABPU028	28	28	21,280	-	75	100	600
ABPU032	32	32	24,087	1"	75	50	300
ABPU037	37	37	28,817	-	75	50	300
ABPU040	40	40	33,750	-	75	50	300
ABPU050	50	50	43,973	-	75	50	200
ABPU063	63	63	59,623	2"	75	50	150



EJEMPLOS DE APLICACIÓN



 Bolsa autoservicio

CÓDIGO	MEDIDA	€/BOLSA	PCS BLS	BOLSAS
LSABPU016	16	4,858	20	5
LSABPU018	18	5,136	20	5
LSABPU020	20	5,222	20	5
LSABPU022	22	5,912	20	5
LSABPU025	25	5,190	15	5
LSABPU028	28	4,319	10	6
LSABPU032	32	3,179	6	6
LSABPU037	37	2,856	4	6
LSABPU040	40	2,894	4	6
LSABPU050	50	3,262	4	6
LSABPU063	63	3,547	4	6

VENTAJAS

Con refuerzo
Fijación rápida
Dos puntos de fijación

AB-IP

Grapa puente isofónica para montaje

02
P. 257
Info.
Técnica

SANEAMIENTO



CÓDIGO	MEDIDA	ØD(mm)	€/100	Nº AGUJEROS	MEDIDA EN PULGADAS		
ABIP015	15	15	58,610	3	-	50	600
ABIP018	18	18	64,583	3	3/8"	50	300
ABIP022	22	22	70,863	3	1/2"	50	300
ABIP026	26	26	82,823	4	3/4"	50	300
ABIP028	28	28	88,540	4	-	50	300
ABIP035	35	35	100,697	4	1"	50	150
ABIP042	42	42	109,533	4	1 1/4"	25	100
ABIP048	48	48	118,373	4	1 1/2"	25	100
ABIP054	54	54	131,670	5	-	25	100
ABIP060	60	60	148,290	5	2"	25	75
ABIP067	67	67	164,923	5	-	25	75
ABIP075	75	75	175,943	6	2 1/2"	25	75
ABIP090	90	90	207,930	6	3"	25	75

AB-SI

Soporte para grapa puente isofónica

02
P. 257
Info.
Técnica

SANEAMIENTO



AB-SI

Soporte para grapa puente isofónica



CÓDIGO	MEDIDA	MÉTRICA TALADRO	€/100	Nº AGUJEROS		
ABSI003	3	M6	199,107	3	25	-
ABSI004	4	M6	231,777	4	25	-
ABSI005	5	M6	266,423	5	25	150
ABSI006	6	M6	299,993	6	25	-
ABSI007	7	M6	335,640	7	25	-
ABSI008	8	M6	368,530	8	25	-
ABSI009	9	M6	401,637	9	25	-
ABSI010	10	M6	420,953	10	25	-
ABSI011	11	M6	460,283	11	25	-
ABSI012	12	M6	494,723	12	25	-
ABSI013	13	M6	527,000	13	25	-
ABSI014	14	M6	553,970	14	25	-
ABSI015	15	M6	588,850	15	25	-
ABSI016	16	M6	622,003	16	10	-
ABSI017	17	M6	669,457	17	10	-
ABSI018	18	M6	726,917	18	10	-
ABSI019	19	M6	735,423	19	10	-
ABSI020	20	M6	792,850	20	10	-
ABSI021	21	M6	801,273	21	10	-
ABSI022	22	M6	835,727	22	10	-
ABSI025	25	M6	986,440	25	10	-

VENTAJAS

Para montajes en paralelo
Instalación fácil y rápida
De acuerdo al CTE

AB-TO

Tornillo para montaje AB-IP

CÓDIGO	MEDIDA	€/100	
ABTO06015	M6 x 15	8,887	100



EJEMPLOS DE APLICACIÓN



Abrazadera sin fin

AB-SF



02 Info
Técnica
p. 258

SANEAMIENTO



AB-SF

Cincada



CÓDIGO	MEDIDA	ØD(mm)	€/100	MEDIDA EN PULGADAS		
ASF008016	8-16	8-16	31,543	5/16"-5/8"	100	1.200
ASF012022	12-22	12-22	32,550	1/2"-7/8"	100	600
ASF016027	16-27	16-27	34,270	5/8"-1 1/16"	100	600
ASF020032	20-32	20-32	38,427	3/4"-1 1/4"	100	600
ASF025040	25-40	25-40	44,833	1"-1 5/8"	100	400
ASF030045	30-45	30-45	50,050	1 3/16"-1 3/4"	100	300
ASF035050	35-50	35-50	50,343	1 3/8"-2"	100	200
ASF040060	40-60	40-60	58,300	1 5/8"-2 3/8"	100	200
ASF050070	50-70	50-70	64,640	2"-2 3/4"	50	100
ASF060080	60-80	60-80	67,770	2 3/8"-3 1/8"	50	100
ASF070090	70-90	70-90	74,720	2 3/4"-3 1/2"	50	-
ASF080100	80-100	80-100	80,690	3 1/8"-4"	50	-
ASF090110	90-110	90-110	89,473	3 1/2"-4 3/8"	50	-
ASF100120	100-120	100-120	98,200	4"-4 3/4"	25	-
ASF110130	110-130	110-130	101,010	4 3/8"-5 1/8"	25	-
ASF120140	120-140	120-140	107,517	4 3/4"-5 1/2"	25	-
ASF130150	130-150	130-150	111,227	5 1/8"-5 7/8"	25	-



02 Blíster

Bolsa autoservicio

CÓDIGO	MEDIDA	€/BOLSA	PCS 	BOLSAS 
BZASF008016	8-16	2,561	2	20
BZASF012022	12-22	2,561	2	20
BZASF016027	16-27	2,561	2	20
BZASF020032	20-32	2,561	2	10
BZASF025040	25-40	2,561	2	10

CÓDIGO	MEDIDA	€/BOLSA	PCS 	BOLSAS 
LSASF008016	8-16	6,881	15	7
LSASF012022	12-22	6,017	12	7
LSASF016027	16-27	6,166	12	7
LSASF020032	20-32	5,858	10	7
LSASF025040	25-40	4,082	6	7
LSASF030045	30-45	4,503	6	7
LSASF035050	35-50	4,541	6	7
LSASF040060	40-60	3,727	4	7
LSASF050070	50-70	3,984	4	7



02 Info
Técnica
p. 258

INOXIDABLE



AB-SF A2

Inoxidable A2

CÓDIGO	MEDIDA	ØD(mm)	€/100	MEDIDA EN PULGADAS		
ASF2010016	10-16	10-16	95,663	-	100	1.200
ASF2012020	12-20	12-20	98,043	1/2"-7/8"	100	600
ASF2016027	16-27	16-27	102,270	5/8"-1 1/16"	100	600
ASF2020032	20-32	20-32	115,347	3/4"-1 1/4"	100	600
ASF2025040	25-40	25-40	126,033	1"-1 5/8"	100	200
ASF2032050	32-50	32-50	175,423	1 3/8"-2"	100	300
ASF2040060	40-60	40-60	186,260	1 5/8"-2 3/8"	100	200
ASF2050070	50-70	50-70	194,387	2"-2 3/4"	50	100
ASF2060080	60-80	60-80	204,343	2 3/8"-3 1/8"	50	100
ASF2070090	70-90	70-90	215,207	2 3/4"-3 1/2"	50	100
ASF2080100	80-100	80-100	222,420	3 1/8"-4"	50	100
ASF2090110	90-110	90-110	259,380	3 1/2"-4 3/8"	50	100
ASF2100120	100-120	100-120	269,563	4"-4 3/4"	25	25
ASF2110130	110-130	110-130	279,720	4 3/8"-5 1/8"	25	25
ASF2120140	120-140	120-140	293,967	4 3/4"-5 1/2"	25	25
ASF2130150	130-150	130-150	305,160	5 1/8"-5 7/8"	25	25



VENTAJAS

Tornillo, fleje y jaula en inoxidable A2
Para varios Ø de tubo
Capacidad media de apriete

EJEMPLOS DE APLICACIÓN



AB-SF IR

Abrazadera sin fin inoxidable en rollo

AB-SF IR

Kit (Rollo 3 m. + 8 cabezales).
Inoxidable



INOXIDABLE



CÓDIGO	MEDIDA	€/PC		
ASFIR03	9 x 0,6 mm/ 3 m	14,867	1	50

AB-SF IRC

Cabezal inoxidable



INOXIDABLE



CÓDIGO	MEDIDA	€/100		
ASFIRCA	Cabezal	106,197	50	1.000

AB-SF IRR

Rollo 30 m. Inoxidable



INOXIDABLE



CÓDIGO	MEDIDA	€/PC		
ASFIR30	9 x 0,6 mm/ 30 m	53,097	1	10

CI-PE

Cinta perforada

CI-PE

Cinta perforada curva. ATLANTIS C2-M



SANEAMIENTO



CÓDIGO	MEDIDA	€/PC	UD. MIN. VENTA		
CIPE1208	12 x 0,8 x 10 m	7,084	10	1	40
CIPE1708	17 x 0,8 x 10 m	9,531	10	1	30



CI-PE A2

Cinta perforada curva. Inoxidable A2



INOXIDABLE



CÓDIGO	MEDIDA	€/PC		
CIPEA21708	17 x 0,8 x 10 m	38,747	1	30



Cinta perforada

CI-PE

02 Info
P. 259 Técnica

SANEAMIENTO



CÓDIGO	MEDIDA	€/PC	UD. MIN. VENTA		
CIPR1208	12 x 0,8 x 10 m	7,710	5	1	40
CIPR1908	19 x 0,8 x 10 m	10,706	5	1	30

CI-PR

Cinta perforada recta ATLANTIS C2-M





Abrazadera cromada M6

AB-CR

02 Info
P. 259 Técnica

SANEAMIENTO



CÓDIGO	MEDIDA	ØD(mm)	€/100	MEDIDA EN PULGADAS	CARGA MÁXIMA		
ABCR010	10 (M6)	10	34,150	1/8"	70	100	1.200
ABCR012	12 (M6)	12	35,980	1/4"	70	100	1.200



EJEMPLOS DE APLICACIÓN



Abrazadera inoxidable Indextube

AB-IT

SANEAMIENTO

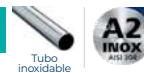

CÓDIGO	MEDIDA	€/100		
ABITS015	15	193,863	100	600
ABITS018	18	210,063	100	400
ABITS022	22	311,367	100	400
ABITS028	28	418,547	100	300



AB-ITS

Simple

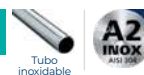

SANEAMIENTO



CÓDIGO	MEDIDA	€/100		
ABITD015	15	716,737	50	300
ABITD018	18	811,463	50	200
ABITD022	22	1.016,350	50	100

AB-ITD

Doble



AB-BU

Abrazadera butano



02 Info. Técnica
P. 259

SANEAMIENTO



CÓDIGO	MEDIDA	ØD(mm)	€/100	MEDIDA EN PULGADAS		
ABBU1315	13 - 15	13-15	32,373	1/2" - 9/16"	50	600
ABBU1618	16 - 18	16-18	32,373	5/8" - 11/16"	50	600
ABBU1921	19 - 21	19-21	48,410	3/4" - 13/16"	50	600

EJEMPLOS DE APLICACIÓN



AB-GM

Abrazadera gásmica con tirafondo amarilla



02 Info. Técnica
P. 260

SANEAMIENTO



CÓDIGO	MEDIDA	ØD(mm)	€/100	MEDIDA EN PULGADAS	CARGA MÁXIMA		
ABGM012	12 (M6)	12	38,913	1/4"	70	100	600
ABGM015	15 (M6)	15	41,283	-	70	100	600
ABGM018	18 (M6)	18	42,410	3/8"	70	100	600
ABGM022	22 (M6)	22	44,787	1/2"	70	50	200
ABGM028	28 (M6)	28	47,293	3/4"	70	50	200
ABGM035	35 (M6)	35	56,973	-	70	50	200

De acuerdo a
UNE-EN ISO 4892

VENTAJAS

- Apertura lateral
- Tirafondo ensamblado
- Instalación rápida

EJEMPLOS DE APLICACIÓN





Abrazadera gásmica negra M6 con tirafondo

AB-CS

02 Info
P. 260 Técnica

SANEAMIENTO



CÓDIGO	MEDIDA	ØD(mm)	€/100	MEDIDA EN PULGADAS	CARGA MÁXIMA		
ABGS010	10 (M6)	10	38,163	1/8"	70	100	600
ABGS012	12 (M6)	12	38,840	1/4"	70	100	600
ABGS015	15 (M6)	15	39,700	-	70	100	600
ABGS018	18 (M6)	18	40,803	3/8"	70	100	600
ABGS022	22 (M6)	22	44,747	1/2"	70	50	200
ABGS028	28 (M6)	28	47,240	3/4"	70	50	200
ABGS035	35 (M6)	35	54,777	-	70	50	200
ABGS042	42 (M6)	42	60,427	1 1/4"	70	25	100
ABGS054	54 (M6)	54	81,467	-	70	25	100





De acuerdo a
UNE-EN ISO 4892

VENTAJAS

Apertura lateral
Tirafondo ensamblado
Para tuberías de gas

 Bolsa autoservicio

CÓDIGO	MEDIDA	€/BOLSA	PCS 	BOLSAS 
LSABGS015	15 (M6)	6,787	10	6
LSABGS018	18 (M6)	5,607	8	6
LSABGS022	22 (M6)	5,097	6	6



Abrazadera gásmica negra doble M6 con tirafondo

AB-GD

02 Info
P. 260 Técnica

SANEAMIENTO



CÓDIGO	MEDIDA	ØD(mm)	€/100	MEDIDA EN PULGADAS	CARGA MÁXIMA		
ABGD012	12 (M6)	12	52,833	-	100	50	300
ABGD015	15 (M6)	15	57,043	-	100	50	300
ABGD018	18 (M6)	18	64,193	3/8"	100	50	300
ABGD022	22 (M6)	22	65,787	1/2"	100	50	200
ABGD028	28 (M6)	28	86,600	-	100	50	200



De acuerdo a
UNE-EN ISO 4892

VENTAJAS

Para montaje en paralelo
Tirafondo ensamblado

EJEMPLOS DE APLICACIÓN





SISTEMAS DE PROTECCIÓN CONTRA INCENDIOS



AB-PE

Abrazadera colgante pera

 Info.
Técnica
P. 261

SANEAMIENTO

 Tubo acero

 Tubo incendios

 Z
ZINC



VENTAJAS

Homologación FM
Sin tornillos
Instalación rápida
Instalación contra incendios

CÓDIGO	MEDIDA	ØD(mm)	€/100	MEDIDA EN PULGADAS	CARGA MÁXIMA		
ABPE028	28 (M10)	DN 20	92,530	3/4"	154	50	200
ABPE035	35 (M10)	DN 25	97,043	1"	186	50	200
ABPE040	40 (M10)	DN 32	113,593	1 1/4"	195	50	200
ABPE048	48 (M10)	DN 40	114,223	1 1/2"	236	50	200
ABPE060	60 (M10)	DN 50	129,390	2"	288	50	200
ABPE075	75 (M10)	DN 65	149,627	2 1/2"	426	25	100
ABPE090	90 (M10)	DN 80	168,503	3"	481	25	100
ABPE100	100 (M10)	DN 90	207,657	3 1/2"	569	25	100
ABPE115	115 (M10)	DN 100	280,920	4"	669	25	100
ABPE140	140 (M12)	DN 125	500,513	5"	907	10	40
ABPE160	160 (M12)	DN 150	584,793	6"	1186	10	40
ABPE220	220 (M12)	DN 200	1.023,393	8"	1723	10	40

EJEMPLOS DE APLICACIÓN



AB-CH

Abrazadera para tubería Clevis

 Info.
Técnica
P. 261

SANEAMIENTO

 Z
ZINC



VENTAJAS

Los bordes ensanchados ayudan a evitar que las superficies afiladas entren en contacto con la tubería.

La parte inferior de la horquilla gira para permitir que la tubería se alimente desde cualquier dirección.

CÓDIGO	HOMOLOGACIÓN	MEDIDA	ØD(mm)	€/100	
ABCH00034	UL	3/4"	28	295,807	50
ABCH01000	UL	1"	35	312,197	50
ABCH01012	UL	1 1/2"	48	339,183	50
ABCH01014	UL	1 1/4"	42	314,143	50
ABCH02000	UL	2"	60	347,327	50
ABCH02012	UL & FM	2 1/2"	75	632,753	30
ABCH03000	UL & FM	3"	90	652,797	25
ABCH04000	UL & FM	4"	115	1.198,397	25
ABCH05000	UL & FM	5"	140	1.662,590	25
ABCH06000	UL & FM	6"	160	2.353,080	10
ABCH08000	UL & FM	8"	220	3.527,287	10
ABCH10000	UL	10"	275	6.016,037	1
ABCH12000	UL	12"	325	7.985,753	1
ABCH14000	-	14"	355	10.313,593	1
ABCH16000	-	16"	405	14.813,397	1

Collarín intumescente

AB-CI

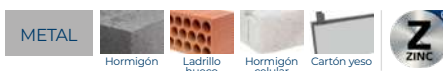



CÓDIGO	MEDIDA	€/PC	
ABCIKIT25	2,5 m x 50 mm	503,893	1
ABCIKIT30	3 m x 50 mm	595,637	1



Anclaje metálico tipo cuña. Homologado ETE

AN-CU



CÓDIGO	MEDIDA	€/100	Ø BROCA		
ANCU06040	6 x 40 Ø6	31,010	6	100	1.200
ANCU06070	6 x 70 Ø6	48,607	6	100	1.200





SOPORTES PARA CANALONES



TE

Soportes de canalón

TE-MO

Módulo para canal de PVC



CÓDIGO	ØD(mm)	A(MM)	€/100	
TEM025	100	60	281,590	50
TEM033	150	80	347,060	50

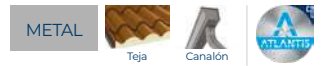
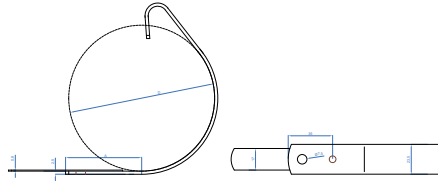

TE-GA

Gancho para canal de PVC



CÓDIGO	ØD(mm)	€/100	
TEGA25	100	424,513	50
TEGA33	150	443,517	50

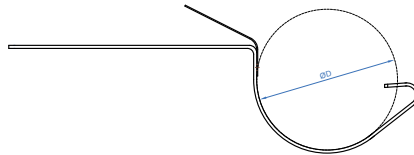

TE-GR

Placa teja grande



CÓDIGO	A(MM)	B(MM)	L(MM)	€/100	
TEGR2530	35	50	80	275,033	50

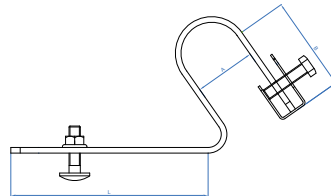

TE-PE

Placa teja



CÓDIGO	A(MM)	B(MM)	L(MM)	€/100	
TEPE2530	22	50	100	256,827	50

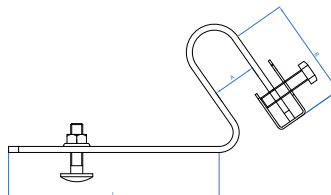

EJEMPLOS DE APLICACIÓN





ABRAZADERAS PLÁSTICAS



Las bridas de Nylon® y sus accesorios son uno de los productos de mayor demanda en el mundo de la instalación profesional. Están indicadas para todo tipo de aplicaciones, tales como instalaciones eléctricas, jardinería, cableado industrial, construcción, DIY, cadenas de fabricación o instalaciones fotovoltaicas. La gama de bridas de INDEX está compuesta de una amplia variedad de colores y tamaños, bridas detectables y accesorios varios. Contamos con la certificación UNE-EN 62275 (marcado CE) y con la homologación UL.



CUALIDADES Y VENTAJAS



INSTALACIÓN RÁPIDA Y SENCILLA

El diseño ergonómico de la cola flexible de la brida facilita un enhebrado fácil y suave.



ALTAS PRESTACIONES

El diseño del cabezal garantiza una alta resistencia a la tracción, garantizando un fuerte tensado. Hasta 122,3 Kg* de carga de rotura según EN 50146.

*En brida con anchura de 12 mm.



DENTADO INTERIOR

El diseño del dentado interior asegura un óptimo ajuste de la brida sin dañar el objeto a fijar.



MÁXIMA CALIDAD Y GARANTÍAS

La calidad de las bridas de INDEX está garantizada con los más altos estándares de calidad, gracias a la certificación de acuerdo con la norma UNE-EN 62275, que permite el marcado CE y con homologación UL.

APLICACIONES



- Cableados en general:
- Cableados eléctricos, sujeción de mangueras, agrupación de mangueras de cables
- Plantas Solares
- Automoción y Aeronáutica
- Embalaje de Productos
- Parques Infantiles
- Industria Farmacéutica y Alimentación
- Bricolaje y Jardinería
- Arte y Manualidades
- Instalaciones con requisitos HACCP/APPCC (bridas desechables)

GAMA



BRIDAS BLANCAS Y NEGRAS

Las bridas de Nylon® blancas y negras de dentado interior son muy versátiles, ya que sirven para numerosos usos en múltiples industrias. Están disponibles en una gran variedad de tamaños, permitiendo una óptima fijación del elemento a fijar, ya sean mazos de cables, tubos y/o mangueras.

Las bridas negras, fabricadas con poliamida y aditivo negro, disponen de una mayor resistencia a la radiación ultravioleta, siendo aptas para aplicaciones en exterior. Las bridas blancas (naturales) están indicadas para aplicaciones en interior.



Son idóneas para uso en instalaciones donde sea necesaria una alta resistencia a álcalis, aceites, grasas, derivados del aceite o disolventes clorados. Por el contrario, tienen una resistencia limitada a ácidos y no son resistentes a fenoles.



BRIDAS DE COLORES

Las bridas de colores están indicadas para el cableado en cajas de conexión en las que se agrupan distintos mazos de cables, permitiendo identificarlos de manera rápida y sencilla y posibilitando ordenar visualmente el espacio de trabajo. También se utilizan en aquellas aplicaciones donde se requiera que las bridas pasen desapercibidas (vallados).

Disponibles en una amplia gama de medidas en color **marrón, amarillo, azul, rojo, verde y gris**.



BRIDAS DETECTABLES

Las bridas detectables están especialmente diseñadas para la utilización en la industria alimentaria, cosmética, farmacéutica y en todas aquellas que sean aplicaciones donde se deben **cumplir los requisitos de la metodología HACCP* o APPCC** (Análisis de Peligros y Puntos Críticos de Control).

Fabricadas en Poliamida 6.6 con partículas metálicas, disponen de **propiedades magnéticas que permiten la detección** con un detector de metales, así como por equipos de inspección de rayos X. Además, su particular color azul facilita su detección visual.



PACKAGING Y PUNTO DE VENTA



La bolsa donde se venden las bridas dispone de toda la información necesaria de un solo vistazo.

En la etiqueta está impreso las dimensiones de la brida, la temperatura de uso, el tamaño mínimo y máximo de diámetro, la tensión soportada, código o EAN. Se trata de una bolsa de plástico de alta calidad que garantiza su estanqueidad para mantener el contenido de humedad recomendada.

Las bridas se presentan tres opciones de presentación en lineal:



BOLSAS COLGADAS EN GANCHOS



BOLSAS COLOCADAS EN BANDEJAS



BOLSAS EN CAJAS EXPOSITOARIAS

RECOMENDACIONES DE USO Y ALMACENAJE DE LAS BRIDAS

Las bridas de INDEX están fabricadas en poliamida de alta calidad, un material plástico higroscópico, es decir, que el material absorbe y pierde agua en función de las condiciones externas (humedad y temperatura). Para garantizar una correcta manipulación y una óptima conservación de la poliamida, las bolsas de bridas contienen el nivel de humedad adecuado.

Recomendamos seguir las siguientes indicaciones para un correcto comportamiento del producto:



No abrir la bolsa hasta el momento de usarlas y una vez abiertas utilizarlas lo antes posible o bien almacenarlas en bolsas de plástico herméticas.



No almacenar cerca de fuentes de calor.



Condiciones óptimas de almacenamiento: 23°C de temperatura y 50% de humedad relativa.



No exponer directamente al sol.



Bridas de nylon

BN

MULTIMATERIAL

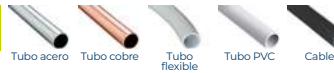

BN-N

Negra

CÓDIGO	MEDIDA	€/100			
BN25080	2,5 x 80	1,337	100	1.000	60.000
BN25100	2,5 x 100	1,557	100	1.000	50.000
BN25140	2,5 x 140	2,377	100	1.000	50.000
BN25160	2,5 x 160	2,587	100	1.000	50.000
BN25200	2,5 x 200	3,267	100	1.000	35.000
BN36140	3,6 x 140	3,287	100	1.000	30.000
BN36200	3,6 x 200	4,477	100	1.000	25.000
BN36250	3,6 x 250	6,077	100	1.000	12.000
BN36300	3,6 x 300	7,060	100	1.000	12.000
BN36370	3,6 x 370	9,367	100	1.000	12.000
BN48120	4,8 x 120	4,793	100	1.000	23.000
BN48160	4,8 x 160	5,333	100	1.000	23.000
BN48180	4,8 x 180	5,687	100	1.000	16.000
BN48200	4,8 x 200	5,817	100	1.000	16.000
BN48250	4,8 x 250	8,400	100	1.000	12.000
BN48290	4,8 x 290	9,100	100	1.000	11.000
BN48370	4,8 x 370	11,730	100	1.000	8.000
BN48430	4,8 x 430	16,107	100	1.000	8.000
BN76150	7,6 x 150	12,400	100	1.000	12.000
BN76200	7,6 x 200	13,423	100	1.000	9.000
BN76290	7,6 x 290	17,070	100	1.000	5.000
BN76370	7,6 x 370	21,487	100	1.000	5.000
BN76450	7,6 x 450	32,727	100	1.000	3.000
BN76540	7,6 x 540	38,333	100	1.000	3.000
BN88770	8,8 x 770	72,487	50	1.000	1.000
BN12225	12,5 x 225	47,370	50	500	2.000
BN12500	12,5 x 500	96,850	50	500	1.000
BN12720	12,5 x 720	137,573	50	500	1.000
BN12850	12,5 x 850	159,090	50	500	1.000
BN12100	12,5 x 1000	195,337	50	500	1.000



PAHs

Blíster

CÓDIGO	MEDIDA	€/BOLSA	PCS	BOLSAS
BZBN25100	2,5 x 100	2,024	20	20
BZBN25160	2,5 x 160	2,024	20	20
BZBN25200	2,5 x 200	2,024	20	20
BZBN36140	3,6 x 140	2,024	20	20
BZBN36200	3,6 x 200	2,024	20	20
BZBN36300	3,6 x 300	2,561	20	15
BZBN48160	4,8 x 160	2,561	20	15
BZBN48200	4,8 x 200	2,561	20	15
BZBN48290	4,8 x 290	2,561	10	15
BZBN48370	4,8 x 370	2,561	10	15

Caja expositora

CÓDIGO	MEDIDA	€/BOLSA	PCS	BOLSAS
CKBN25080	2,5 x 80	1,400	100	30
CKBN25100	2,5 x 100	1,631	100	30
CKBN25140	2,5 x 140	2,495	100	30
CKBN25160	2,5 x 160	2,714	100	20
CKBN25200	2,5 x 200	3,426	100	20
CKBN36140	3,6 x 140	3,449	100	20
CKBN36200	3,6 x 200	4,699	100	20
CKBN36300	3,6 x 300	7,413	100	10
CKBN36370	3,6 x 370	9,833	100	10
CKBN48120	4,8 x 120	5,038	100	20
CKBN48160	4,8 x 160	5,602	100	20
CKBN48180	4,8 x 180	5,969	100	20
CKBN48200	4,8 x 200	6,112	100	20
CKBN48250	4,8 x 250	8,826	100	10
CKBN48290	4,8 x 290	9,551	100	10
CKBN48370	4,8 x 370	12,312	100	10
CKBN76200	3,6 x 200	14,095	100	10
CKBN76290	7,6 x 290	17,930	100	10
CKBN76370	3,6 x 370	22,559	100	8
CKBN12225	12,5 x 225	24,868	50	10



BN

Bridas de nylon

BN-B

Blanca

MULTIMATERIAL



PAHs

CÓDIGO	MEDIDA	€/100			
BB25080	2,5 x 80	1,337	100	1.000	60.000
BB25100	2,5 x 100	1,557	100	1.000	50.000
BB25140	2,5 x 140	2,377	100	1.000	50.000
BB25160	2,5 x 160	2,587	100	1.000	50.000
BB25200	2,5 x 200	3,267	100	1.000	35.000
BB36140	3,6 x 140	3,287	100	1.000	30.000
BB36200	3,6 x 200	4,477	100	1.000	25.000
BB36250	3,6 x 250	6,077	100	1.000	12.000
BB36300	3,6 x 300	7,060	100	1.000	12.000
BB36370	3,6 x 370	9,367	100	1.000	12.000
BB48120	4,8 x 120	4,793	100	1.000	23.000
BB48160	4,8 x 160	5,333	100	1.000	23.000
BB48180	4,8 x 180	5,687	100	1.000	16.000
BB48200	4,8 x 200	5,817	100	1.000	16.000
BB48250	4,8 x 250	8,400	100	1.000	12.000
BB48290	4,8 x 290	9,100	100	1.000	11.000
BB48370	4,8 x 370	11,730	100	1.000	8.000
BB48430	4,8 x 430	16,107	100	1.000	8.000
BB76150	7,6 x 150	12,400	100	1.000	12.000
BB76200	7,6 x 200	13,423	100	1.000	9.000
BB76290	7,6 x 290	17,070	100	1.000	5.000
BB76370	7,6 x 370	21,487	100	1.000	5.000
BB76450	7,6 x 450	32,727	100	1.000	3.000
BB76540	7,6 x 540	38,333	100	1.000	3.000
BB88770	8,8 x 770	72,487	50	1.000	1.000
BB12225	12,5 x 225	47,370	50	500	2.000
BB12500	12,5 x 500	96,850	50	500	1.000
BB12720	12,5 x 720	137,573	50	500	1.000
BB12850	12,5 x 850	159,090	50	500	1.000
BB12100	12,5 x 1000	195,337	50	500	1.000

Blíster

CÓDIGO	MEDIDA	€/BOLSA	PCS BOLSAS	BOLSAS
BZBB25100	2,5 x 100	2,024	20	20
BZBB25160	2,5 x 160	2,024	20	20
BZBB25200	2,5 x 200	2,024	20	20
BZBB36140	3,6 x 140	2,024	20	20
BZBB36200	3,6 x 200	2,024	20	20
BZBB36300	3,6 x 300	2,561	20	15
BZBB48160	4,8 x 160	2,561	20	15
BZBB48200	4,8 x 200	2,561	20	15
BZBB48290	4,8 x 290	2,561	10	15
BZBB48370	4,8 x 370	2,561	10	15

Caja expositora

CÓDIGO	MEDIDA	€/BOLSA	PCS BOLSAS	BOLSAS
CKBB25080	2,5 x 80	1,400	100	30
CKBB25100	2,5 x 100	1,631	100	30
CKBB25140	2,5 x 140	2,495	100	30
CKBB25160	2,5 x 160	2,714	100	20
CKBB25200	2,5 x 200	3,426	100	20
CKBB36140	3,6 x 140	3,449	100	20
CKBB36200	3,6 x 200	4,699	100	20
CKBB36300	3,6 x 300	7,413	100	10
CKBB36370	3,6 x 370	9,833	100	10
CKBB48120	4,8 x 120	5,038	100	20
CKBB48160	4,8 x 160	5,602	100	20
CKBB48180	4,8 x 180	5,969	100	20
CKBB48200	4,8 x 200	6,112	100	20
CKBB48250	4,8 x 250	8,826	100	20
CKBB48290	4,8 x 290	9,551	100	10
CKBB48370	4,8 x 370	12,312	100	10
CKBB76200	3,6 x 200	14,095	100	10
CKBB76290	7,6 x 290	17,930	100	10
CKBB76370	3,6 x 370	22,559	100	8
CKBB12225	12,5 x 225	24,868	50	8

Bridas de nylon colores

BN-CO

MULTIMATERIAL

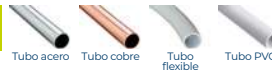

CÓDIGO	MEDIDA	€/100		
BC25100GR	2,5 x 100	1,993	100	50.000
BC36140GR	3,6 x 140	3,983	100	30.000
BC36200GR	3,6 x 200	5,607	100	25.000
BC48200GR	4,8 x 200	7,120	100	16.000
BC48290GR	4,8 x 290	11,183	100	11.000

BN-GR

Gris



MULTIMATERIAL

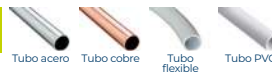

CÓDIGO	MEDIDA	€/100		
BC25100VE	2,5 x 100	1,643	100	50.000
BC36140VE	3,6 x 140	3,953	100	30.000
BC36200VE	3,6 x 200	5,347	100	25.000
BC48200VE	4,8 x 200	6,957	100	16.000
BC48290VE	4,8 x 290	10,937	100	11.000

BN-VE

Verde



Caja expositora

CÓDIGO	MEDIDA	€/BOLSA	PCS 	BOLSAS 
CKBC25100VE	2,5 x 100	1,726	100	30
CKBC36140VE	3,6 x 140	4,155	100	20
CKBC36200VE	3,6 x 200	5,611	100	20
CKBC48200VE	4,8 x 200	7,306	100	20
CKBC48290VE	4,8 x 290	11,486	100	10

MULTIMATERIAL

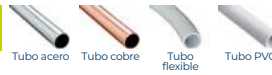

CÓDIGO	MEDIDA	€/100		
BC25100MA	2,5 x 100	1,643	100	50.000
BC36140MA	3,6 x 140	3,953	100	30.000
BC36200MA	3,6 x 200	5,347	100	25.000
BC48200MA	4,8 x 200	6,957	100	16.000
BC48290MA	4,8 x 290	10,937	100	11.000

BN-MA

Marrón



Caja expositora

CÓDIGO	MEDIDA	€/BOLSA	PCS 	BOLSAS 
CKBC25100MA	2,5 x 100	1,726	100	30
CKBC36140MA	3,6 x 140	4,155	100	20
CKBC36200MA	3,6 x 200	5,611	100	20
CKBC48200MA	4,8 x 200	7,306	100	18
CKBC48290MA	4,8 x 290	11,486	100	10

MULTIMATERIAL

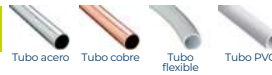

CÓDIGO	MEDIDA	€/100		
BC25100AM	2,5 x 100	1,643	100	50.000
BC36140AM	3,6 x 140	3,953	100	30.000
BC36200AM	3,6 x 200	5,347	100	25.000
BC48200AM	4,8 x 200	6,957	100	16.000
BC48290AM	4,8 x 290	10,937	100	11.000

BN-AM

Amarilla



BN-CO

Bridas de nylon colores

BN-AZ

Azul

MULTIMATERIAL



CÓDIGO	MEDIDA	€/100		
BC25100AZ	2,5 x 100	1,643	100	50.000
BC36140AZ	3,6 x 140	3,953	100	30.000
BC36200AZ	3,6 x 200	5,347	100	25.000
BC48200AZ	4,8 x 200	6,957	100	16.000
BC48290AZ	4,8 x 290	10,937	100	11.000

Caja expositora

CÓDIGO	MEDIDA	€/BOLSA	PCS	BOLSAS
CKBC25100AZ	2,5 x 100	1,726	100	30
CKBC36140AZ	3,6 x 140	4,155	100	20
CKBC36200AZ	3,6 x 200	5,611	100	20
CKBC48200AZ	4,8 x 200	7,306	100	18
CKBC48290AZ	4,8 x 290	11,486	100	10

BN-RO

Rojo

MULTIMATERIAL



CÓDIGO	MEDIDA	€/100		
BC25100RO	2,5 x 100	1,643	100	50.000
BC36140RO	3,6 x 140	3,953	100	30.000
BC36200RO	3,6 x 200	5,347	100	25.000
BC48200RO	4,8 x 200	6,957	100	16.000
BC48290RO	4,8 x 290	10,937	100	11.000

Caja expositora

CÓDIGO	MEDIDA	€/BOLSA	PCS	BOLSAS
CKBC25100RO	2,5 x 100	1,726	100	30
CKBC36140RO	3,6 x 140	4,155	100	20
CKBC36200RO	3,6 x 200	5,611	100	20
CKBC48200RO	4,8 x 200	7,306	100	18
CKBC48290RO	4,8 x 290	11,486	100	10

BN-DT

Brida detectable

MULTIMATERIAL



CÓDIGO	MEDIDA	€/100		
BNDT25100	2,5 x 100	3,873	100	50.000
BNDT36150	3,6 x 150	9,030	100	30.000
BNDT36200	3,6 x 200	11,610	100	25.000
BNDT48200	4,8 x 200	14,190	100	16.000
BNDT48300	4,8 x 300	21,927	100	11.000
BNDT48370	4,8 x 370	30,957	100	8.000
BNDT76370	7,6 x 370	56,757	100	5.000

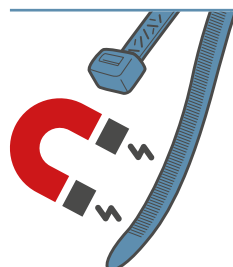

BRIDA DETECTABLE con partículas metálicas

- TRIPLE DETECCIÓN:



MAGNÉTICA



RAYOS X



VISUAL

- COMPATIBLE COMO PARTE DEL PROCESO HACCP*/APPCC**.

*HACCP: Hazard Analysis and Critical Control Points). Sistema de inocuidad alimentaria basado en la identificación de todos los peligros potenciales en los ingredientes y los distintos procesos de producción de los alimentos.

** APPCC: Análisis de Peligros y Puntos Críticos de Control.



Taco para bridas

TACOBRI

MULTIMATERIAL



CÓDIGO	MEDIDA	COLOR	€/100		
TACOBRIE8	Ø8	NEGRO	6,130	100	5.000
TACOBRIE6	Ø6	NEGRO	6,993	100	5.000

Blíster

CÓDIGO	MEDIDA	€/BOLSA	PCS	BOLSAS
BZTABRIE8	Ø8	2,024	4	15

Caja expositora

CÓDIGO	MEDIDA	€/BOLSA	PCS	BOLSAS
CKTACOBRI6	Ø6	7,410	100	10
CKTACOBRI8	Ø8	6,563	100	10

TACOBRI N

Negro



MULTIMATERIAL



CÓDIGO	MEDIDA	COLOR	€/100		
TACOBRI8	Ø8	BLANCO	6,620	100	5.000
TACOBRI6	Ø6	BLANCO	7,213	100	5.000

Blíster

CÓDIGO	MEDIDA	€/BOLSA	PCS	BOLSAS
BZTABRI8	Ø8	2,024	4	15

Caja expositora

CÓDIGO	MEDIDA	€/BOLSA	PCS	BOLSAS
CKTACOBRI6	Ø6	7,577	100	10
CKTACOBRI8	Ø8	6,950	100	10

TACOBRI B

Blanco



MULTIMATERIAL



CÓDIGO	MEDIDA	COLOR	€/100		
TACOBRI8	Ø8	GRIS	8,043	100	5.000

TACOBRI G

Gris

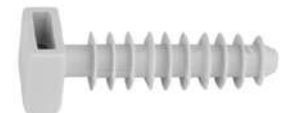

Bridas de nylon con identificación

BN-ID

MULTIMATERIAL



CÓDIGO	MEDIDA	€/100		
BID25110	2,5 x 110	10,087	100	16.000
BID25210	2,5 x 210	22,190	100	12.000



Placa de identificación de nylon de hasta 4,8 mm

BN-PL

MULTIMATERIAL



CÓDIGO	MEDIDA	€/100		
BPL02616	26,4 x 16,2	23,783	100	5.000



BN-BA

Base de dos vías adhesivas para bridas de nylon



MULTIMATERIAL



CÓDIGO	MEDIDA	COLOR	€/100		
BBANA19	19 x 19	BLANCO	21,743	100	15.000
BBANE19	19 x 19	NEGRO	21,743	100	15.000
BBANA27	27 x 27	BLANCO	31,107	100	6.000
BBANE27	27 x 27	NEGRO	31,107	100	6.000

AB-IN

Clip simple de polipropileno con casquillo de latón M6



Info. Técnica
p. 262

SANEAMIENTO

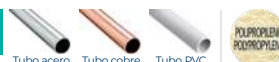

CÓDIGO	MEDIDA	ØD(mm)	€/100		
ABINO12	12	12	32,807	100	1.200
ABINO14	14-15	14-15	35,677	100	600
ABINO16	16-18	16-18	44,897	100	600
ABINO20	20-22	20-22	47,020	100	400
ABINO25	25	25	59,583	50	300
ABINO28	28	28	60,840	50	300
ABINO32	32	32	81,560	25	150
ABINO35	35	35	92,550	25	300

VENTAJAS

Fijación por presión de la tubería
Con inserto M6 en latón

Bolsa autoservicio

CÓDIGO	MEDIDA	€/BOLSA	PCS	BOLSAS
LSABINO12	12	5,787	10	6
LSABINO14	14-15	6,060	10	5
LSABINO16	16-18	5,630	8	6
LSABINO20	20-22	4,887	6	5
LSABINO28	28	4,457	4	6

INSTALACIÓN

PERFIL



AB-ID

Clip doble de polipropileno con casquillo de latón M6



Info. Técnica
p. 262

SANEAMIENTO



CÓDIGO	MEDIDA	ØD(mm)	€/100		
ABIDO12	12	12	66,623	50	200
ABIDO14	14-15	14-15	69,937	50	300
ABIDO16	16-18	16-18	89,240	50	200
ABIDO20	20-22	20-22	94,533	50	150
ABIDO28	28	28	116,717	25	100

VENTAJAS

Para montajes en paralelo
Fijación por presión de la tubería
Con inserto M6 en latón

Bolsa autoservicio

CÓDIGO	MEDIDA	€/BOLSA	PCS	BOLSAS
LSABIDO12	12	5,963	6	6
LSABIDO14	14-15	6,207	6	5
LSABIDO16	16-18	3,627	2	6
LSABIDO20	20-22	3,730	2	6
LSABIDO28	28	4,177	2	6

INSTALACIÓN

PERFIL



EJEMPLOS DE APLICACIÓN





Abrazadera guía simple con pre-rosca M6

AB-GU



SANEAMIENTO



CÓDIGO	MEDIDA	ØD(mm)	€/100		
ABGUG15	15	15	24,737	100	400
ABGUG18	18	18	24,987	100	400
ABGUG20	20	20	26,300	100	400
ABGUG22	22	22	27,857	100	300
ABGUG25	25	25	30,950	50	300
ABGUG28	28	28	38,713	50	200
ABGUG32	32	32	42,153	25	150
ABGUG40	40	40	56,067	25	150
ABGUG50	50	50	67,237	25	100



VENTAJAS
Con pre-rosca M6

Bolsa autoservicio

CÓDIGO	MEDIDA	€/BOLSA	PCS	BOLSAS
LSABGUG15	15	3,646	8	6
LSABGUG18	18	3,344	6	6
LSABGUG20	20	2,867	4	7
LSABGUG22	22	2,997	4	7
LSABGUG25	25	2,647	2	6
LSABGUG28	28	2,692	2	6
LSABGUG32	32	2,822	2	6
LSABGUG40	40	3,039	2	6
LSABGUG50	50	3,258	2	6

INSTALACIÓN

PERFIL



PISTOLA



TACO + TORNILLO



CAÑÓN ELECTRICISTA



Abrazadera multidímetro

AB-MUG



SANEAMIENTO



CÓDIGO	MEDIDA	ØD(mm)	€/100		
ABMUG15	15-16	15	21,977	100	400
ABMUG18	18-20	18	27,703	100	400
ABMUG22	22-25	22	32,910	100	300
ABMUG26	26-28	26	41,103	50	150
ABMUG32	32-35	32	53,047	50	150
ABMUG40	40-42	40	71,767	50	100
ABMUG48	48-50	42	86,263	25	75



VENTAJAS
Para varios Ø de tubo
Con pre-rosca M6

Bolsa autoservicio

CÓDIGO	MEDIDA	€/BOLSA	PCS	BOLSAS
LSABMUG15	15-16	3,557	8	6
LSABMUG18	18-20	3,457	6	6
LSABMUG22	22-25	3,077	4	7
LSABMUG26	26-28	2,633	2	6
LSABMUG32	32-35	2,887	2	6

INSTALACIÓN

PERFIL



PISTOLA



TACO + TORNILLO



CAÑÓN ELECTRICISTA



AB-PR

Abrazadera a presión con pre-rosca M6



02 Info. Técnica P. 263

SANEAMIENTO



CÓDIGO	MEDIDA	ØD(mm)	€/100		
ABPRG15	15-18	15-18	25,473	100	400
ABPRG20	20-22	20-22	27,057	100	400
ABPRG25	25-28	25-28	32,133	100	300
ABPRG32	32-35	32-35	44,857	25	150
ABPRG40	40	40	57,893	25	150
ABPRG50	50	50	72,970	25	100

Bolsa autoservicio

CÓDIGO	MEDIDA	€/BOLSA	PCS	BOLSAS
LSABPRG15	15-18	3,903	8	6
LSABPRG20	20-22	3,103	4	5
LSABPRG25	25-28	2,907	3	6

VENTAJAS

Fijación por presión de la tubería
Con pre-rosca M6
Clip para unión en paralelo.

INSTALACIÓN



AB-MS

Abrazadera multitubo + taco. Simple



02 Info. Técnica P. 263

SANEAMIENTO



CÓDIGO	MEDIDA	ØD(mm)	€/100	CARGA MÁXIMA		
ABMS10	5 x 20 Ø5	10	29,840	9	100	1.200
ABMS12	5 x 20 Ø5	12	31,807	9	100	1.200
ABMS14	6 x 25 Ø6	14	44,337	15	100	600
ABMS16	6 x 25 Ø6	16	45,760	15	100	600
ABMS18	8 x 30 Ø8	18	60,177	16	100	300
ABMS20	8 x 30 Ø8	20	61,607	16	50	300
ABMS22	8 x 30 Ø8	22	62,973	16	50	300
ABMS26	10 x 40 Ø10	26	118,527	30	50	150
ABMS28	10 x 40 Ø10	28	120,423	30	50	150

AB-MD

Abrazadera multitubo + taco. Doble



02 Info. Técnica P. 264

SANEAMIENTO



CÓDIGO	MEDIDA	ØD(mm)	€/100	CARGA MÁXIMA		
ABMD10	8 x 30 Ø8	10	59,007	16	100	300
ABMD12	8 x 30 Ø8	12	60,207	16	100	300
ABMD14	8 x 30 Ø8	14	61,410	16	100	300
ABMD16	8 x 30 Ø8	16	60,443	16	100	300
ABMD18	10 x 40 Ø10	18	85,397	30	100	200
ABMD20	10 x 40 Ø10	20	90,643	30	50	150
ABMD22	10 x 40 Ø10	22	93,360	30	50	150
ABMD26	10 x 40 Ø10	26	149,040	30	50	100
ABMD28	10 x 40 Ø10	28	150,180	30	50	100



Taco para fijación de tubo INDEXring

AB-T

Info
Técnica
P. 264

SANEAMIENTO



CÓDIGO	MEDIDA	ØD(mm)	€/100	MEDIDA EN PULGADAS		
ABTS014	14	14 - 15	30,677	-	100	600
ABTS016	16	16 - 17	31,780	3/8"	100	400
ABTS018	18	18 - 19	34,343	-	100	400
ABTS020	20	20 - 21	34,917	1/2"	100	300
ABTS022	22	22 - 23	35,810	-	100	300
ABTS025	25	25 - 26	36,970	3/4"	100	300
ABTS028	28	28 - 29	43,890	-	100	200
ABTS032	30	30 - 32	56,570	-	50	150

Bolsa autoservicio

CÓDIGO	MEDIDA	€/BOLSA	PCS	BOLSAS
LSABTS018	18	4,187	6	6
LSABTS022	22	4,462	6	6

AB-TS

Simple

Info
Técnica
P. 265

SANEAMIENTO



CÓDIGO	MEDIDA	ØD(mm)	€/100	MEDIDA EN PULGADAS		
ABTD016	16	15 - 16	37,407	3/8"	100	400
ABTD018	18	18 - 19	42,533	-	100	300
ABTD020	20	20 - 21	43,547	1/2"	100	200
ABTD022	22	22 - 23	46,893	-	100	200
ABTD025	25	25 - 26	51,060	3/4"	100	200
ABTD028	28	28 - 29	68,050	-	50	150

Bolsa autoservicio

CÓDIGO	MEDIDA	€/BOLSA	PCS	BOLSAS
LSABTD018	18	3,905	4	6
LSABTD022	22	2,926	2	7

AB-TD

Doble

Info
Técnica
P. 265

SANEAMIENTO



CÓDIGO	MEDIDA	ØD(mm)	€/100	MEDIDA EN PULGADAS		
ABTC020	20	20 - 21	72,453	1/2"	50	100
ABTC025	25	25 - 26	89,087	3/4"	50	100

AB-TC

Cuádruple



EJEMPLOS DE APLICACIÓN



VENTAJAS
Taladro Ø8 x 35
Montaje en paralelo. 2 tubos (AB-TD)
y 4 (AB-TC)

FI-CA

Fijaciones para cables

FI-CA AB

Abrazadera



MULTIMATERIAL



CÓDIGO	MEDIDA	€/100		
FICAAB080	80	160,000		50
FICAAB119	119	266,667		25

FI-CA PS

Pinza simple



MULTIMATERIAL



CÓDIGO	MEDIDA	€/100		
FICAPS080	80	76,667	50	1.500

FI-CA PD

Pinza doble



MULTIMATERIAL



CÓDIGO	MEDIDA	€/100		
FICAPD160	80 (x2)	113,333	50	800

FI-CA CL

Clip



MULTIMATERIAL



CÓDIGO	MEDIDA	€/100	TALADRO		
FICACL13	Ø13	16,333	6	200	2.400
FICACL26	Ø16	21,667	6	100	1.200

Fijaciones para cables

FI-CA

SANEAMIENTO



CÓDIGO	MEDIDA	VÁLIDO PARA	€/100	UD. MIN. VENTA	
GRBL001	2 x 0,7	Cable Paralelo	6,390	400	100
GRBL010	2 x 0,7 - 2 x 1	Cable Plano 6 x 3	8,117	400	100
GRBL100	2 x 4	Cable redondo Ø10	11,570	200	100
GRBL120	3 x 6	Cable redondo Ø12	14,207	200	100
GRBL140	4 x 6	Cable Redondo Ø14	16,877	200	100
GRBL002	2 x 0,4 - 0,7 ó 1	Cable Paralelo	6,740	400	100
GRBL020	2 x 1,5 - 3 x 1	Cable Plano 7,5 x 3,5	8,243	400	100
GRBL003	2 x 1 - 3 x 0,7	Cable Plano 6 x 2	6,820	400	100
GRBL030	3 x 1,5 - 3 x 2,5	Cable Plano 10 x 3,5	9,973	400	100
GRBL040	1 x 1 - 2 x 0,5	Cable Redondo Ø4	7,860	400	100
GRBL050	2 x 0,75	Cable Redondo Ø5	8,073	400	100
GRBL060	2 x 1	Cable Redondo Ø6	8,550	400	100
GRBL070	2 x 1-1,5	Cable Redondo Ø7	9,327	400	100
GRBL080	2 x 2,5	Cable Redondo Ø8	9,410	400	100
GRBL090	3 x 2,5	Cable Redondo Ø9	10,363	400	100

GR-NY BL

Grapilla de nylon con clavo de acero cincado. Blanca



Blíster

CÓDIGO	MEDIDA	€/BOLSA	PCS	BOLSAS
BZGRB001	2 x 0,7	2,561	6	20
BZGRB010	2 x 0,7 - 2 x 1	2,561	6	20
BZGRB100	2 x 4	2,561	6	20
BZGRB120	3 x 6	2,561	6	15
BZGRB050	2 x 0,75	2,561	6	20
BZGRB060	2 x 1	2,561	6	20
BZGRB070	2 x 1-1,5	2,561	6	20
BZGRB080	2 x 2,5	2,561	6	20
BZGRB090	3 x 2,5	2,561	6	20

SANEAMIENTO



CÓDIGO	MEDIDA	VÁLIDO PARA	€/100	UD. MIN. VENTA	
GRNE100	2 x 4	Cable Redondo	11,570	200	100
GRNE120	3 x 6	Cable Redondo	14,207	200	100
GRNE060	2 x 1	Cable Redondo	8,550	400	100
GRNE070	2 x 1 - 2 x 1,5	Cable Redondo	9,327	400	100
GRNE080	2 x 2,50	Cable Redondo	9,410	400	100
GRNE090	3 x 2,50	Cable Redondo	10,363	400	100

GR-NY N

Grapilla de nylon con clavo de acero cincado. Negra



SANEAMIENTO



CÓDIGO	MEDIDA	VÁLIDO PARA	€/100	UD. MIN. VENTA		
GRNATTV	GRAPILLA - CLIP - CRAMPON TV - CLIP	Cable Redondo	11,160	200	100	2.000

GR-NY NT

Grapilla de nylon con clavo de acero cincado. Natural





PERFILERÍA Y SOPORTACIÓN





PUENTES GUÍA		TORNILLOS GUÍA		TUERCAS GUÍA		TAPONES	
GZ2718							
PGZ2830							
PGZ3840							
PGI2718							
PGI2830							
PGI3840							
PGX4121							
PGX4141							
TC230620	M6 x 20						
TC230820	M8 x 20						
TC230830	M8 x 30						
TC340830	M8 x 30						
TC341030	M10 x 30						
TCR230620	M6 x 20						
TCR230820	M8 x 20						
TCR230830	M8 x 30						
TCR340830	M8 x 30						
TCR341030	M10 x 30						
TCRX0830	M8 x 30						
TCRX0860	M8 x 60						
TCRX1030	M10 x 30						
TCRX1060	M10 x 60						
TUG201006	M6						
TUG201008	M8						
TUG271808	M8						
TUG271810	M10						
TUGRA2706	M6						
TUGRA2708	M8						
TUGRA3808	M8						
TUGRA3810	M10						
TUCX08	M8						
TUCX10	M10						
TUCXMU08	Muelle						
TUCXMU10	Muelle						
TURX08							
TURX10							
TURX12							
TURXA08							
TURXA10							
SOTP2718							
SOTP2830							
SOTP3840							
SOTP4121							
SOTP4141							

GP

Perfiles para cargas ligeras tipo "C"

GP-Z

Guía perforada cincada



METAL



CÓDIGO	MEDIDA	€/100	LONGITUD	
GPZ201010	20 x 10 x 1 x 2000	873,067	2.000	30
GPZ250808	25 x 8 x 0,80 x 1000	695,063	1.000	30

GP-G

Guía perforada ATLANTIS C2-H



METAL



CÓDIGO	MEDIDA	€/100	LONGITUD	
GPG271812	27 x 18 x 1,25 x 2000	1.577,873	2.000	10
GPG283018	28 x 30 x 1,8 x 2000	3.241,913	2.000	10
GPG351312	35 x 13 x 1,2 x 2000	2.084,800	2.000	10
GPG384020	38 x 40 x 2 x 2000	5.355,083	2.000	6
GPG402015	40 x 20 x 1,50 x 2000	2.337,110	2.000	10

GP-A2

Guía perforada inoxidable A2



INOXIDABLE



CÓDIGO	MEDIDA	€/100	LONGITUD	
GPI271812	27 x 18 x 1,25 x 2000	12.995,763	2.000	6
GPI283015	28 x 30 x 1,50 x 2000	20.997,927	2.000	6
GPI384020	38 x 40 x 2,00 x 2000	43.456,517	-	5

GP-PL

Guía perforada plastificada amarilla



METAL



CÓDIGO	MEDIDA	€/100	LONGITUD	
GPP271812	27 x 18 x 1,25	2.069,667	1.000	10

GP-PVC

Guía perforada PVC



METAL



CÓDIGO	MEDIDA	€/100	LONGITUD	
GPV251120	25 x 11 x 2 x 1000	843,660	1.000	30

Perfiles para cargas ligeras tipo "C"

GP

METAL



CÓDIGO	MEDIDA	€/100	
GLO357510	35x7,5x1,0	947,953	10
GLO351515	35x15x1,5	1.611,807	10

GL-O

Guía Omega lisa ATLANTIS C2-M



METAL



CÓDIGO	MEDIDA	€/100	
GPO351515	35x15x1,5	1.606,820	10
GPO357510	35x7,5x1,0	898,427	10

GP-O

Guía Omega perforada ATLANTIS C2-M



Soportes para cargas ligeras tipo "C"

SP

METAL



CÓDIGO	MEDIDA	€/100	
SPZ271820	27 x 18 x 1,25 x 200	735,317	10
SPZ271830	27 x 18 x 1,25 x 300	793,490	10
SPZ384020	38 x 40 x 2 x 200	1.202,397	10
SPZ384025	38 x 40 x 2 x 250	1.349,800	10
SPZ384030	38 x 40 x 2 x 300	1.484,187	10
SPZ384035	38 x 40 x 2 x 350	1.590,140	10
SPZ384040	38 x 40 x 2 x 400	1.853,350	10
SPZ384050	38 x 40 x 2 x 500	2.250,770	10
SPZ384060	38 x 40 x 2 x 600	2.506,433	10

SP-Z

Soporte perforado cincado



METAL



CÓDIGO	MEDIDA	VÁLIDO PARA	€/100	
SPV2718	M10 (27/18-28/30)	27/18 - 28/30	526,700	50
SPV3840	M10 (38/40-40/20)	38/40 - 40/20	559,983	50

SP-V

Soporte vertical



SP

Soportes para cargas ligeras tipo "C"

SP-H

Soporte horizontal



METAL



CÓDIGO	MEDIDA	VÁLIDO PARA	€/100	
SPH2718	M10 (27/18-28/30)	27/18 - 28/30	470,463	50
SPH3840	M10 (38/40-40/20)	38/40 - 40/20	487,950	50

SP-HX

Soporte horizontal carriles



METAL



CÓDIGO	MEDIDA	VÁLIDO PARA	€/100	
SPGH2718	M10 (27/18-28/30)	27/18 - 28/30	738,657	10
SPGH3840	M10 (38/40-40/20-41/21-41/41)	38/40 - 40/20 - 41/21 - 41/41	1.435,620	10

PE-AC

Accesorios para perfiles tipo "C"

TO-GU

Tope tornillo guía



METAL



CÓDIGO	MEDIDA	VÁLIDO PARA	€/100		
TG230620	M6 x 20	20/10 - 27/18 - 28/30 - 25/08 - 25/11	68,463	100	800
TG230820	M8 x 20	27/18 - 28/30 - 25/08	85,220	100	400
TG230830	M8 x 30	27/18 - 28/30 - 25/08	89,697	100	600
TG340830	M8 x 30	38/40 - 40/20	123,427	100	600
TG341030	M10 x 30	38/40 - 40/21	166,487	100	400

TO-GR

Tope tornillo guía de fijación rápida



METAL



CÓDIGO	MEDIDA	VÁLIDO PARA	€/100		
TGR230620	M6x20	20/10 - 25/08 - 25/11 - 27/18 - 28/30	189,513	100	600
TGR230820	M8x20	20/10 - 25/08 - 25/11 - 27/18 - 28/30	200,320	100	600
TGR230830	M8x30	20/10 - 25/08 - 25/11 - 27/18 - 28/30	205,090	100	600
TGR340830	M8x30	27/18 - 28/30 - 38/40 - 40/20	257,597	100	400
TGR341030	M10x30	27/18 - 28/30 - 38/40 - 40/20	290,863	50	300

TU-GU

Tuerca guía perforada



METAL



CÓDIGO	MEDIDA	VÁLIDO PARA	€/100		
TUG201006	M6	20/10 - 25/08 - 27/18 - 28/30	18,470	100	3.000
TUG201008	M8	20/10 - 25/08 - 27/18 - 28/30	18,470	100	2.400
TUG271808	M8	27/18 - 28/30 - 38/40 - 40/20	49,737	100	1.200
TUG271810	M10	27/18 - 28/30 - 38/40 - 40/20	49,737	100	1.200

Accesorios para perfiles tipo "C"

PE-AC

METAL



CÓDIGO	MEDIDA	VÁLIDO PARA	€/100		
TUGRA2706	M6	20/10 - 25/08 - 25/11 - 27/18 - 28/30	169,863	50	600
TUGRA2708	M8	20/10 - 25/08 - 25/11 - 27/18 - 28/30	169,863	50	600
TUGRA3808	M8	27/18 - 28/30 - 38/40 - 40/20	217,840	50	600
TUGRA3810	M10	27/18 - 28/30 - 38/40 - 40/20	231,900	50	600

TU-GRA

Tuerca guía con arandela de fijación rápida



METAL



CÓDIGO	MEDIDA	VÁLIDO PARA	€/100		
EMZ45	50 x 50 45°	25/11 - 27/18 - 28/30 - 38/40 - 40/20 - 41/21 - 41/41	129,903	100	400
EMZ90	54 x 54 90°	25/11 - 27/18 - 28/30 - 38/40 - 40/20 - 41/21 - 41/41	129,903	100	300
EMZ00	100 180°	25/11 - 27/18 - 28/30 - 38/40 - 40/20 - 41/21 - 41/41	126,657	100	-

EG-Z

Escuadra cincada



INOXIDABLE



CÓDIGO	MEDIDA	VÁLIDO PARA	€/100		
EMI45	50 x 50 45°	27/18 - 28/30 - 38/40	634,667	50	200
EMI90	54 x 54 90°	27/18 - 28/30 - 38/40	634,667	50	-
EMI00	100 180°	27/18 - 28/30 - 38/40	629,223	50	200

EG-A2

Escuadra inoxidable A2



METAL



CÓDIGO	MEDIDA	VÁLIDO PARA	€/100	
PUZ2718	M8 (27/18-28/30)	27/18-28/30	58,593	50
PUZ3840	M8 (38/40)	38/40	64,800	50

PU-Z

Placa de unión para perfiles



METAL



CÓDIGO	MEDIDA	VÁLIDO PARA	€/100		
PGZ2718	27 / 18 x 81	27/18	109,603	50	300
PGZ2830	28 / 30 x 81	28/30	132,737	50	300
PGZ3840	38 / 40 x 93	38/40	148,093	50	100

PG-Z

Puente guía cincado



INOXIDABLE



CÓDIGO	MEDIDA	VÁLIDO PARA	€/100		
PGI2718	27 / 18 x 81	27/18	309,567	50	300
PGI2830	28 / 30 x 81	28/30	356,003	50	200
PGI3840	38 / 40 x 93	38/40	433,393	50	100

PG-A2

Puente guía inoxidable A2



PE-AC

Accesorios para perfiles tipo "C"

SO-TP

Tapones plásticos



METAL



CÓDIGO	MEDIDA	VÁLIDO PARA	€/100		
SOTP2718	27/18	27/18	31,497	100	400
SOTP2830	28/30	28/30	37,880	100	300
SOTP3840	38/40	38/40	61,410	100	300
SOTP4121	41/21	41/21	50,470	100	600
SOTP4141	41/41	41/41	52,917	100	300

GPX

Perfiles para cargas pesadas Indextrut

GP-X 21

Guía perforada Indextrut 41x21



METAL



CÓDIGO	MEDIDA	€/100	LONGITUD	
GPX412115	41 x 21 x 1,5	5.050,800	3.000	10
GPX412120	41 x 21 x 2	5.677,757	3.000	10
GPX2M412120	41 x 21 x 2	3.970,457	2.000	10
GPX412125	41 x 21 x 2,5	7.783,403	3.000	6

GP-X 41

Guía perforada Indextrut 41x41



METAL



CÓDIGO	MEDIDA	€/100	LONGITUD	
GPX414115	41 x 41 x 1,5	6.130,973	3.000	10
GPX414120	41 x 41 x 2	9.330,137	3.000	6
GPX2M414120	41 x 41 x 2	6.287,797	2.000	10
GPX414125	41 x 41 x 2,5	10.990,217	3.000	6

SPX

Soportes para cargas pesadas Indextrut

SP-X

Soprote perforado Indextrut



METAL



CÓDIGO	MEDIDA	€/100	LONGITUD	
SPX412115	41 x 21 x 2,5 x 150	1.063,867	150	10
SPX412130	41 x 21 x 2,5 x 300	1.464,590	300	10
SPX412145	41 x 21 x 2,5 x 450	1.859,970	450	10
SPX414110	41 x 41 x 2,5 x 1000	4.815,140	1.000	2
SPX414115	41 x 41 x 2,5 x 150	1.378,573	150	10
SPX414130	41 x 41 x 2,5 x 300	1.931,263	300	10
SPX414145	41 x 41 x 2,5 x 450	2.525,467	450	10
SPX414160	41 x 41 x 2,5 x 600	3.175,243	600	10
SPX414175	41 x 41 x 2,5 x 750	3.828,900	750	10

SP-RX

Soprote base rectangular "U" Indextrut



METAL



CÓDIGO	MEDIDA	VÁLIDO PARA	€/100	
SPRXH4121	M12(41/21-41/41)	Indextrut 41/41 - 41/21	1.412,417	12
SPRXV4121	M12(41/21-41/41)	Indextrut 41/41 - 41/21	1.412,417	12

Soportes para cargas pesadas Indextrut

SPX

METAL



CÓDIGO	MEDIDA	VÁLIDO PARA	€/100	
SPUX412100	M16 (41/21-41/41)	Indextrut 41/41 - 41/21	1.794,760	12
SPUX412145	M16 (41/21-41/41)	Indextrut 41/41 - 41/21	1.794,760	12

SP-UX

Soporte base cuadrada "U" Indextrut



METAL



CÓDIGO	MEDIDA	VÁLIDO PARA	€/100	
PRX01	M8 (41/21-41/41)	Indextrut 41/41 - 41/21	1.559,357	12



PR-X

Soporte regulable Indextrut



METAL



CÓDIGO	MEDIDA	VÁLIDO PARA	€/100		
RESX300	252 x 252 x 6 (300)	Indextrut 41/41 - 41/21	1.184,137	10	20
RESX550	428 x 428 x 6 (550)	Indextrut 41/41 - 41/21	1.886,377	10	20

RE-SX

Refuerzo para soportes Indextrut



Accesorios para perfiles Indextrut

PX-AC

METAL



CÓDIGO	MEDIDA	VÁLIDO PARA	€/100		
SOTP2718	27/18	27/18	31,497	100	400
SOTP2830	28/30	28/30	37,880	100	300
SOTP3840	38/40	38/40	61,410	100	300
SOTP4121	41/21	41/21	50,470	100	600
SOTP4141	41/41	41/41	52,917	100	300

SO-TP

Tapones plásticos



METAL



CÓDIGO	MEDIDA	VÁLIDO PARA	€/100		
TGX0840	M8 x 40	Indextrut 41/41 - 41/21	123,063	100	400
TGX0860	M8 x 60	Indextrut 41/41 - 41/21	131,900	50	300
TGX1040	M10 x 40	Indextrut 41/41 - 41/21	157,303	50	300
TGX1060	M10 x 60	Indextrut 41/41 - 41/21	176,437	50	200

TG-X

Tope tornillo Guía Indextrut



METAL



CÓDIGO	MEDIDA	€/100	
TGRX0830	M8x30	288,477	100
TGRX0860	M8x60	301,673	50
TGRX1030	M10x30	327,923	50
TGRX1060	M10x60	348,140	50

TO-GRX

Tope tornillo Guía de fijación rápida Indextrut



PX-AC

Accesorios para perfiles Indextrut

TU-GX

Tuerca guía Indextrut



METAL



CÓDIGO	MEDIDA	VÁLIDO PARA	€/100		
TUGX08	M8	Indextrut 41/41 - 41/21	75,357	100	800
TUGX10	M10	Indextrut 41/41 - 41/21	83,327	100	800

TU-MU

Tuerca guía Indextrut con muelle



METAL



CÓDIGO	MEDIDA	VÁLIDO PARA	€/100		
TUGXMU08	M8	Indextrut 41/41	110,117	100	400
TUGXMU10	M10	Indextrut 41/41	110,117	100	400

TU-RX

Tuerca guía de fijación Rápida Indextrut



METAL



CÓDIGO	MEDIDA	VÁLIDO PARA	€/100		
TURX08	M8	Indextrut 41/41 - 41/21	104,310	100	400
TURX10	M10	Indextrut 41/41 - 41/21	119,170	100	400
TURX12	M12	Indextrut 41/41 - 41/21	132,157	50	300

TU-RXA

Tuerca guía con arandela de fijación rápida Indextrut



METAL



CÓDIGO	MEDIDA	€/100	
TURXA08	M8	251,753	50
TURXA10	M10	275,193	50

EG-X

Escuadra para Indextrut



METAL



CÓDIGO	MEDIDA	VÁLIDO PARA	€/100	Nº AGUJEROS		
EMX1302	71/48 x 40 x 5 135°	Indextrut 41/41 - 41/21	316,503	2	20	100
EMX4502	86/52 x 40 x 5 45°	Indextrut 41/41 - 41/21	297,320	2	25	125
EMX9002	48 x 51 x 5 90°	Indextrut 41/41 - 41/21	194,220	2	50	150
EMX9004	95 x 98 x 5 90°	Indextrut 41/41 - 41/21	306,913	4	25	75

Accesorios para perfiles Indextrut

PX-AC

METAL



CÓDIGO	MEDIDA	VÁLIDO PARA	€/100	
SCRX090	100 x 100 x 40	Indextrut 41/41 - 41/21	758,293	10

SC-RX

Escuadra reforzada Indextrut



METAL



CÓDIGO	MEDIDA	VÁLIDO PARA	€/100	
EMPX4121	M8 (41/21-41/41)	Indextrut 41/41 - 41/21	1.189,290	10

EMP-X

Empalme Indextrut



METAL



CÓDIGO	MEDIDA	VÁLIDO PARA	€/100	
RTX01	50 x 5	41/21 - 41/41 - 41/62	838,903	10



RT-X

Soporte Rótula Indextrut



METAL



CÓDIGO	MEDIDA	€/100	N° AGUJEROS		
UNPX412101	40 x 40 x 5	80,527	1	50	300
UNPX412102	40 x 90 x 5	166,247	2	25	150
UNPX412103	40 x 138 x 5	233,783	3	25	125
UNPX412104	40 x 186 x 5	290,930	4	10	60

UN-PX

Placa de unión Indextrut



METAL



CÓDIGO	MEDIDA	€/100	N° AGUJEROS	
UNEX412103	89 x 89 x 5	423,387	3	25

UN-EX

Placa de unión Escuadra Indextrut



PX-AC

Accesorios para perfiles Indextrut

UN-TX

Placa de unión "T" Indextrut



METAL



CÓDIGO	MEDIDA	€/100	Nº AGUJEROS	
UNTX412104	138 x 89 x 5	550,400	4	25

PG-X

Puente guía Indextrut



METAL



CÓDIGO	MEDIDA	VÁLIDO PARA	€/100		
PGX4121	41/21 x 40	Indextrut 41/21	390,913	15	90
PGX4141	41/41 x 40	Indextrut 41/41	518,120	10	60

AB-GX

Abrazadera para guía perforada Indextrut



METAL



CÓDIGO	MEDIDA	VÁLIDO PARA	€/100	
ABGX4121	41x21 - 41x41	Indextrut 41/41 - 41/21	571,507	20

VE-AC

Accesorios de ventilación

UN-CO

Unión conducto tipo "C"



METAL



CÓDIGO	MEDIDA	€/100		
UNCO3220	32 x 20	60,450	100	400

SO-PG

Perfil de goma isofónico para soportación



METAL



CÓDIGO	MEDIDA	VÁLIDO PARA	€/PC	
SOPG27	27	27/18 - 28/30	152,687	1
SOPG38	38	38/40 - 40/20	217,873	1
SOPG41	41	41/21 - 41/41	222,893	1



SISTEMAS DE INSTALACIÓN Y FIJACIONES PARA PLACAS SOLARES



ISF-GG

Grapas y galgas para montaje de placas

KFR-SC

Grapa fijación rápida



CÓDIGO	MEDIDA	€/100		
KFRSC3050	30 - 50	583,909	10	240

PGS-A

Perfil grapa



CÓDIGO	MEDIDA	€/100		
PGSA26	26	97,553	20	720

GM-A

Galga de aluminio para marco



CÓDIGO	MEDIDA	€/100		
GMA030 NEW	30	171,799	10	120
GMA035	35	178,031	10	120
GMA040	40	196,104	10	120

ISF-PU

Perfiles, uniones, guías y empalmes para estructura de apoyo

GP-XS

Guía perforada INDEXTUT solar. Acero Atlantis C4-M



CÓDIGO	MEDIDA	€/100	
GPXS4115012	41 x 41 x 1,5 - L.125mm	379,930	50
GPXS4115125 NEW	41 x 41 x 1,5 - L.1250mm	2.026,549	10
GPXS4115187 NEW	41 x 41 x 1,5 - L.1875mm	3.008,748	10
GPXS4115250 NEW	41 x 41 x 1,5 - L.2500mm	3.998,714	6
GPXS4115362 NEW	41 x 41 x 1,5 - L.3625mm	5.779,227	6

EMP-XS

Empalme INDEXTUT solar. Acero Atlantis C4-M



CÓDIGO	MEDIDA	€/100	
EMPXS4115	41 x 1,5	380,483	40

METAL



CÓDIGO	MEDIDA	€/PC		
GPVD4162012	16 x 20 x 1,20	689,234	50	-

GP-VD NEW

Guía perforada INDEXTRUT solar para fijación en valle discontinua. Acero Atlantis C4-M



METAL



CÓDIGO	MEDIDA	€/100	
PSAA0400	80 x 35 - L.400	1.132,690	20
PSAA1250	80 x 35 - L.1250	3.105,327	2
PSAA1875 <small>NEW</small>	80 x 35 - L.1875mm	4.457,928	2
PSAA2500 <small>NEW</small>	80 x 35 - L.2500mm	5.962,750	2
PSAA3625 <small>NEW</small>	80 x 35 - L.3625mm	8.415,697	2

PSA-A

Perfil de aluminio con alas



METAL



CÓDIGO	MEDIDA	VÁLIDO PARA	€/100	
PSAUN200	200	PSA-UN	363,110	20

PSA-UN

Unión de aluminio para perfil PSA-A



METAL



CÓDIGO	MEDIDA	€/100	
PSAAV0150	90 x 75 - L.150	975,520	20

PSA-AV

Perfil de aluminio con alas para fijación directa discontinua en valle



METAL



CÓDIGO	MEDIDA	€/100	
PSEA601250	47 x 60 - L.1250mm	3.956,282	2
PSEA601875	47 x 60 - L.1875mm	5.842,287	2
PSEA602500	47 x 60 - L.2500mm	7.766,231	2
PSEA603625	47 x 60 - L.3625mm	11.169,715	2

PSE-A

Perfil de aluminio para fijación ensamblada



ISF-PU

Perfiles, uniones, guías y empalmes para estructura de apoyo

PSE-UN

Unión de aluminio para perfil PSE-A



METAL



CÓDIGO	MEDIDA	VÁLIDO PARA	€/100	
PSEUN060200	60 x 200	PSE-A	514,100	20

NEW PSE-C

Perfil de aluminio para fijación ensamblada lateral



CÓDIGO	MEDIDA	€/100	
PSEC410125	41 x 41 - L.125mm	418,821	20
PSEC410200	41 x 41 - L.200mm	589,512	20
PSEC411250	41 x 41 - L.1250mm	2.902,064	2
PSEC411875	41 x 41 - L.1875mm	4.166,272	2
PSEC412500	41 x 41 - L.2500mm	5.572,776	2
PSEC413625	41 x 41 - L.3625mm	7.865,000	2

NEW PSE-CUN

Unión de aluminio para perfil PSE-C



METAL



CÓDIGO	MEDIDA	€/100	
PSECUN200	200 mm	404,947	10

ISF-CC

Conectores + Complementos para montaje de estructuras solares

KFS-FI

Conector cruzado para fijación inferior. Inoxidable A2



METAL



CÓDIGO	MEDIDA	€/100		
KFSFIM08	M8	165,976	100	900

KFS-FL

Conector cruzado para fijación lateral. Inoxidable A2



METAL



CÓDIGO	MEDIDA	€/100		
KFSFLM08	M8	294,531	10	80

Conectores + Complementos para montaje de estructuras solares

ISF-CC

METAL



CÓDIGO	MEDIDA	€/100		
TURXA208	M8	141,599	50	300

TU-RX A2

Tuerca rápida INDEXTRUT. Inoxidable A2



METAL



CÓDIGO	MEDIDA	€/100		
D603108016	M8 x 16	42,047	200	2.400

DIN-603 A2

Tornillo DIN-603. Cabeza redonda y cuello cuadrado. Inoxidable A2



Disponible en varios recubrimientos. Consulte precio y plazo de entrega.

METAL



CÓDIGO	MEDIDA	€/100	LLAVE DE INSTALACIÓN		
6921108020	M8 x 20	50,524	13	200	2.400
6921108050	M8 x 50	80,818	13	100	600
6921108070	M8 x 70	117,304	13	100	600

DIN-6921 A2

Tornillo DIN-6921. Tornillo hexagonal con arandela estampada y grafilada. Inoxidable A2



METAL



CÓDIGO	MEDIDA	€/100	LLAVE DE INSTALACIÓN		
D6923IM08	M8	24,660	13	250	3.000
D6923IM10	M10	47,753	15	250	3.000
D6923IM12	M12	70,740	18	250	1.500



DIN-6923 A2

Tuerca brida grafilada DIN-6923. Inoxidable A2



METAL



CÓDIGO	MEDIDA	€/100		
D127IM08	M8	4,530	200	9.000
D127IM10	M10	7,237	100	4.500
D127IM12	M12	10,923	100	4.500

DIN-127 A2

Arandela muelle grower DIN-127. Inoxidable A2



ISF-TR

Triángulos para instalación de placas solares

TPA-R

Triángulo regulable de aluminio premontado



METAL



CÓDIGO	MEDIDA	VÁLIDO PARA	€/PC	
TPAR251500	25° / 30° / 35° - L.1500	PSE-A	57,737	4

TPA-P

Perfil riostra para triángulo de aluminio premontado



METAL



CÓDIGO	MEDIDA	€/100	
TPAP352000	35 x 35 - L.2000	1.535,633	2

TRP-XS

Triángulo regulable premontado INDEXTRUT. Acero con recubrimiento Atlantis C4-M



METAL



CÓDIGO	MEDIDA	VÁLIDO PARA	€/PC	
TRPXS412515	25° - 35° - L.1500	GP-XS	56,582	4



NU-XS

Nudo articulado INDEXTRUT. Acero con recubrimiento Atlantis C4-M



METAL





CÓDIGO	MEDIDA	VÁLIDO PARA	€/100		
NUXSM0841	M8	GP-XS	771,397	10	100

Espárragos regulables para la instalación de placas solares

ISF-KFS



CÓDIGO	MEDIDA	€/100	LLAVE DE INSTALACIÓN		
KFSMA10200	10 x 200	555,310	7	25	150
KFSMA10250	10 x 250	626,317	7	25	150
KFSMA12300 NEW	12 x 300	1.214,187	9	25	75
KFSMA12350 NEW	12 x 350	1.321,193	9	25	75

KFS-MA

Espárrago doble rosca. Inoxidable A2



CÓDIGO	MEDIDA	€/100	LLAVE DE INSTALACIÓN		
KFSAU10160	10 x 160	2.269,407	13	25	150
KFSAU10200	10 x 200	2.633,187	13	25	75

KFS-AU

Kit tornillo autorroscante. Inoxidable
A2



CÓDIGO	MEDIDA	€/100	LLAVE DE INSTALACIÓN		
KFSRV10250	10 x 250	664,097	7	25	150
KFSRV12350	12 x 350	1.117,160	9	25	75

KFS-RV

Varilla roscada para instalación con
anclaje químico. Inoxidable A2



ISF-FR

Accesorios regulables para la instalación de placas solares

GS-TC

Gancho salvateja ajustable para teja curva. Inoxidable A2



METAL



CÓDIGO	MEDIDA	€/100	
GSTC040080	40 - 80	2.799,268	20
GSTC080120	80 - 120	2.852,243	20

GS-TU

Gancho salvateja ajustable para teja universal. Inoxidable A2



METAL



CÓDIGO	MEDIDA	€/100	
GSTU040055	40 - 55	2.872,958	20

STR

Soporte regulable para perfil trapecoidal. Inoxidable A2



METAL



CÓDIGO	MEDIDA	€/100	
STR1680	16 - 80	1.944,181	40

PMO

Placa para tornillo doble rosca. Inoxidable A2



METAL



CÓDIGO	MEDIDA	€/100		
PMO1012	M10 -M12	263,027	25	300

NEW PMO-L

Pletina en "L" de aluminio para fijación lateral. Válida para perfil PSE-C



METAL



CÓDIGO	MEDIDA	€/100	UD. MIN. VENTA	
PMOL1012	M10 -M12	164,333	-	25

Accesorios regulables para la instalación de placas solares

ISF-FR



CÓDIGO	MEDIDA	€/100	UD. MIN. VENTA	
MOTL16330	16 x 330	312,304	-	10

MO-TL **NEW**

Tamiz largo recortable para fijación en cubierta teja + rasillón



CÓDIGO	MEDIDA	€/100	UD. MIN. VENTA	
MOPC185	185 mm	4,220	-	1

MO-PC **NEW**



Extensor de cánula para fijaciones químicas



Accesorios de fijación directa para la instalación de placas solares

ISF-FD



CÓDIGO	MEDIDA	€/100	Nº HUELLA		
TACN165525	5,5 x 25 P16	41,087	8	500	2.000

TAC + ARVUL

Tornillo de cosido Atlantis C4-M + Arandela vulcanizada EPDM





CÓDIGO	MEDIDA	€/100	Nº HUELLA		
TACB166025	6 x 25 P16	99,783	8	500	2.000

TAC BIMETAL+ARVUL A2

Tornillo de cosido Bimetal + Arandela vulcanizada EPDM-inoxidable A2



CÓDIGO	MEDIDA	€/100		
AUENI166325	6,25 x 25 P-16	38,000	500	2.000

AUE NI + ARVUL **NEW**

Tornillo autorroscante Atlantis C4-M + Arandela vulcanizada EPDM-inoxidable A2



ISF-FD

Accesorios de fijación directa para la instalación de placas solares



NEW DIN-7504-K RE NI + ARVUL

Tornillo autotaladrante punta reducida Atlantis C4-M + Arandela vulcanizada EPDM-inoxidable A2



METAL



CÓDIGO	MEDIDA	€/100			
AREN166325	6,25 x 25 P-16	32,300	8	500	3.000



RE-TE

Remache trebol estanco + Arandela vulcanizada EPDM



METAL



CÓDIGO	MEDIDA	€/100	Ø BROCA		
RETE5220	5,2 x 20	99,830	5,3	250	3.000

ISF-ES

Accesorios de estanqueidad para la instalación de placas solares

ARS-P

Arandela paraguas inoxidable A2 + EPDM



METAL



CÓDIGO	MEDIDA	€/100		
ARSP08	M8	47,160	100	1.200
ARSP10	M10	47,160	100	1.200

ARS-S

Arandela para tornillo doble rosca



METAL



CÓDIGO	MEDIDA	€/100		
ARSS10	M10	23,343	100	1.200
ARSS12	M12	23,343	100	1.200



CS-B

Cinta de estanqueidad de butileno



METAL



CÓDIGO	MEDIDA	€/PC		
CSB0104010	40 x 1 - L.10	20,623	1	27
CSB0108010	80 x 1 - L.10	40,300	1	18

Kits para instalaciones solares

ISF-KT



KC-PSA

Coplanar con perfil con alas de aluminio (PSA-A). Fijación directa



CÓDIGO	MEDIDA	€/PC	
KCPSA0230 NEW	x2 (30 mm) - ORIGEN	190,373	1
KCPSA0235	x2 (35 mm) - ORIGEN	190,373	1
KCPSA0240	x2 (40 mm) - ORIGEN	190,373	1
KCPSA02AM NEW	x2 - AMPLIACION	182,307	1
KCPSA0330 NEW	x3 (30 mm) - ORIGEN	264,587	1
KCPSA0335	x3 (35 mm) - ORIGEN	264,587	1
KCPSA0340	x3 (40 mm) - ORIGEN	264,587	1
KCPSA03AM NEW	x3 - AMPLIACION	254,907	1



KC-PSD

Coplanar con perfil con alas de aluminio (PSA-A). Fijación directa formato de perfil discontinuo





CÓDIGO	MEDIDA	€/PC	
KCPD01AM	x1 - AMPLIACION	43,560	1
KCPD0130	x1 (30 mm) - ORIGEN	87,120	1
KCPD0135	x1 (35 mm) - ORIGEN	87,120	1
KCPD0140	x1 (40 mm) - ORIGEN	87,120	1



KC-PSC **NEW**

Coplanar con perfil de aluminio PSE-C. Fijación ensamblada lateral



CÓDIGO	MEDIDA	€/PC	UD. MIN. VENTA		
KCPSC0230	x2 (30 mm) - ORIGEN	183,920	-	1	-
KCPSC0235	x2 (35 mm) - ORIGEN	183,920	-	1	-
KCPSC0240	x2 (40 mm) - ORIGEN	183,920	-	1	-
KCPSC02AM	x2 - AMPLIACION	174,240	-	1	-
KCPSC0330	x3 (30 mm) - ORIGEN	253,293	-	1	-
KCPSC0335	x3 (35 mm) - ORIGEN	253,293	-	1	-
KCPSC0340	x3 (40 mm) - ORIGEN	253,293	-	1	-
KCPSC03AM	x3 - AMPLIACION	240,387	-	1	-



KC-GPX

Coplanar con guía perforada acero Atlantis C4-M INDEXTUT SOLAR GP-XS



CÓDIGO	MEDIDA	€/PC	
KCGPX0230 NEW	x2 (30 mm) - ORIGEN	154,000	1
KCGPX0235	x2 (35 mm) - ORIGEN	154,000	1
KCGPX0240	x2 (40 mm) - ORIGEN	154,000	1
KCGPX02AM NEW	x2 - AMPLIACION	150,333	1
KCGPX0330 NEW	x3 (30 mm) - ORIGEN	212,667	1
KCGPX0335	x3 (35 mm) - ORIGEN	212,667	1
KCGPX0340	x3 (40 mm) - ORIGEN	212,667	1
KCGPX03AM NEW	x3 - AMPLIACION	205,333	1

ISF-KT

Kits para instalaciones solares

KC-GPD

Coplanar con guía perforada Atlantis C4-M INDEXTRUT SOLAR GP-XS. Formato guía discontinua



CÓDIGO	MEDIDA	€/PC	
KCGPD01AM	x1 - AMPLIACION	25,667	1
KCGPD0130	x1 (30 mm) - ORIGEN	55,000	1
KCGPD0135	x1 (35 mm) - ORIGEN	55,000	1
KCGPD0140	x1 (40 mm) - ORIGEN	55,000	1

KT-PSE

Triangular con perfil de aluminio PSE-A. Fijación ensamblada



CÓDIGO	MEDIDA	€/PC	
KTPSE0230 NEW	x2 (30 mm) - ORIGEN	380,747	1
KTPSE0235	x2 (35 mm) - ORIGEN	380,747	1
KTPSE0240	x2 (40 mm) - ORIGEN	380,747	1
KTPSE02AM NEW	x2 - AMPLIACION	375,907	1
KTPSE0330 NEW	x3 (30 mm) - ORIGEN	542,080	1
KTPSE0335	x3 (35 mm) - ORIGEN	542,080	1
KTPSE0340	x3 (40 mm) - ORIGEN	542,080	1
KTPSE03AM NEW	x3 - AMPLIACION	529,173	1

KT-GPX

Triangular con guía perforada Atlantis C4-M INDEXTRUT SOLAR GP-XS



CÓDIGO	MEDIDA	€/PC	
KTGPX0230 NEW	x2 (30 mm) - ORIGEN	285,450	1
KTGPX0235	x2 (35 mm) - ORIGEN	285,450	1
KTGPX0240	x2 (40 mm) - ORIGEN	285,450	1
KTGPX02AM NEW	x2 - AMPLIACION	277,200	1
KTGPX0330 NEW	x3 (30 mm) - ORIGEN	409,200	1
KTGPX0335	x3 (35 mm) - ORIGEN	409,200	1
KTGPX0340	x3 (40 mm) - ORIGEN	409,200	1
KTGPX03AM NEW	x3 - AMPLIACION	402,600	1



SISTEMAS DE FIJACIÓN RÁPIDA EN VIGA



SU

Sistemas de fijación rápida en viga

SU-MO

Mordaza para viga



 Info.
Técnica
P. 272

METAL   

CÓDIGO	MEDIDA	€/100	ANCHO MÁX. A LA VIGA		
SUMOM06	ROSCADO M6	331,673	20	50	200
SUMOM08	ROSCADO M8	386,520	20	50	200
SUMOP09	PASANTE Ø9	386,520	20	50	200
SUMOM10	ROSCADO M10	424,970	20	50	150
SUMOP11	PASANTE Ø11	424,970	20	50	150
SUMOM12	ROSCADO M12	646,837	25	50	-
SUMOP13	PASANTE Ø13	646,837	25	50	100

SU-CL

Clip de suspensión



 Info.
Técnica
P. 272

METAL   

CÓDIGO	MEDIDA	€/100	LONGITUD MIN. ALA VIGA	ESPESOR VIGA		
SUCL02	6.3	38,577	14	1,5 - 4	100	1.200
SUCL04	6.3	55,177	23	4 - 10	100	400
SUCL10	6.3	64,260	23	10 - 15	100	300
SUCL15	6.3	85,677	23	15 - 20	100	300

SU-VA

Clip varilla



 Info.
Técnica
P. 272

METAL   

CÓDIGO	MEDIDA	€/100	LONGITUD MIN. ALA VIGA	ESPESOR VIGA		
SUVA0602	M6	99,043	14	1,5 - 4	100	300
SUVA0802	M8	99,043	14	1,5 - 4	100	300
SUVA0604	M6	120,650	23	4 - 10	100	200
SUVA0804	M8	120,650	23	4 - 10	100	200
SUVA0610	M6	177,473	23	10 - 15	100	-
SUVA0810	M8	177,473	23	10 - 15	100	200
SUVA0615	M6	214,197	23	15 - 20	100	-
SUVA0815	M8	214,197	23	15 - 20	100	-

Sistemas de fijación rápida en viga

SU

02 Info
P. 273 Técnica



SU-CU

Clip de cuelgue

CÓDIGO	MEDIDA	€/100	ESPESOR VIGA		
SUCU0602	M6	99,483	1,5 - 5	100	300
SUCU0605	M6	110,570	5 - 7	100	300
SUCU0606	M6	138,413	3 - 7	100	200
SUCU0607	M6	163,147	7 - 10	100	200



02 Info
P. 273 Técnica



SU-AB

Clip de viga para abrazadera

CÓDIGO	MEDIDA	€/100	MEDIDA TORNILLO	ESPESOR MÁX. A FIJAR	ANCHO MÁX. A LA VIGA		
SUAB0603	M6	94,023	M6 x 9	3 - 7	3 - 7	100	300
SUAB0607	M6	94,397	M6 x 9	7 - 13	7 - 13	100	200
SUAB0614	M6	98,353	M6 x 9	14 - 20	14 - 20	100	200



02 Info
P. 273 Técnica



SU-CA

Clip de viga para cable

CÓDIGO	MEDIDA	€/100	ESPESOR MÁX. A FIJAR		
SUCA0602	6-7	32,513	1 - 4	100	2.400
SUCA0604	6-7	33,260	4 - 7,5	100	1.200
SUCA0607	6-7	33,777	7,5 - 12	100	1.200
SUCA0802	8-9	33,887	1 - 4	100	1.200
SUCA0804	8-9	34,407	4 - 7,5	100	1.200
SUCA0807	8-9	34,840	7,5 - 12	100	1.200
SUCA1002	10-11	34,567	1 - 4	100	1.200
SUCA1004	10-11	35,100	4 - 7,5	100	1.200
SUCA1007	10-11	35,563	7,5 - 12	100	1.200
SUCA1202	12-14	35,387	1 - 4	100	1.200
SUCA1204	12-14	35,900	4 - 7,5	100	1.200
SUCA1207	12-14	36,033	7,5 - 12	100	1.200
SUCA1502	15-18	36,157	1 - 4	100	1.200
SUCA1504	15-18	36,933	4 - 7,5	100	1.200
SUCA1507	15-18	37,083	7,5 - 12	100	1.200
SUCA1902	19-24	36,997	1 - 4	100	1.200
SUCA1904	19-24	44,830	4 - 7,5	100	600
SUCA1907	19-24	45,700	7,5 - 12	100	600
SUCA2502	25-30	46,080	1 - 4	100	600
SUCA2504	25-30	51,403	4 - 7,5	100	600
SUCA2507	25-30	56,287	7,5 - 12	100	600





FIJACIÓN PARA SANITARIOS Y CLIMATIZACIÓN



RA

Soportes para radiadores de aluminio

RA-TRG

Soporte triangular regulable con goma antivibraciones. 2 PCS x KIT



SANEAMIENTO



CÓDIGO	MEDIDA	€/KIT	KITS x
RATRG095	95	4,371	50



RA-TRI

Soporte triangular 1°



SANEAMIENTO



CÓDIGO	MEDIDA	€/100	KITS x
RATRI095	95	138,317	100

RA-FRE

Soporte ferroli recto. 2 PCS x KIT



SANEAMIENTO



CÓDIGO	MEDIDA	€/KIT	KITS x
RAFRE095	95	4,329	50



RA-FIN

Soporte ferroli inclinado. 2 PCS x KIT



SANEAMIENTO



CÓDIGO	MEDIDA	€/KIT	KITS x
RAFIN100	100	4,578	50



Soportes para radiadores de aluminio

RA

SANEAMIENTO



CÓDIGO	MEDIDA	€/KIT	KITS x
RAR0100	100	7,167	50



RA-RO

Soporte Roca. 2 PCS x KIT



SANEAMIENTO



CÓDIGO	MEDIDA	€/100	KITS x
RAFEM145	145	125,337	250
RAFEM175	175	134,380	250

RA-FEM

Soporte ferrolli para empotrar



SANEAMIENTO



CÓDIGO	MEDIDA	€/100	KITS x
RARAY032	32 x 78	103,637	250

RA-RAY

Soporte Rayco



SANEAMIENTO



CÓDIGO	MEDIDA	€/100	KITS x
RAPES032	32 x 78	111,630	250

RA-PES

Soporte de pestaña



22 KITS SOLUCIONES

easykits

AUMENTA LA VENTA CRUZADA
 PACKAGING MUY VISUAL Y ATRACTIVO
 INFORMACIÓN ÚTIL EN EL PACKAGING
 SOLUCIONES A PRODUCTOS HABITUALES

SA

Soportes de fijación para sanitarios

SA-LN

Fijación de lavabos con tuerca de nylon. 2 PCS x KIT



TN4S
Con taco de multimaterial de alta calidad

SANEAMIENTO

CÓDIGO	MEDIDA	€/KIT	KITS x
SALN08100	M8 x 100	2,227	50
SALN10120	M10 x 120	2,757	50

SA-LH

Fijación de lavabos con tuerca de hierro. 2 PCS x KIT



TAMBIÉN DISPONIBLE EN
easykits
TN4S
Con taco de multimaterial de alta calidad

SANEAMIENTO

CÓDIGO	MEDIDA	€/KIT	KITS x
SALH08100	M8 x 100	2,270	100
SALH10120	M10 x 120	3,160	50

SA-IL

Fijación de WC y bidé con taco largo. 2 PCS x KIT



SANEAMIENTO

CÓDIGO	MEDIDA	€/KIT	KITS x
SAILO6080	M6 x 80	3,017	100

SA-WZ

Fijación WC y bidé, cincado. 2 PCS x KIT



TN4S
Con taco de multimaterial de alta calidad

SANEAMIENTO

CÓDIGO	MEDIDA	€/KIT	KITS x
SAWZ05080	M5 x 80	1,250	300

SA-WL

Fijación WC y bidé, latón. 2 PCS x KIT



TN4S
Con taco de multimaterial de alta calidad

SANEAMIENTO

CÓDIGO	MEDIDA	€/KIT	KITS x
SAWL05080	M5 x 80	3,187	100

Soportes de fijación para sanitarios

SA

SANEAMIENTO



CÓDIGO	MEDIDA	€/KIT	KITS x
SACIO6080	M6 x 80	5,727	100

TAMBIÉN DISPONIBLE EN
easykits

SA-CI

Fijación de cisterna. 2 PCS x KIT



SANEAMIENTO



CÓDIGO	MEDIDA	€/KIT	KITS x
SAWH06070	M6 x 70	2,523	50

TN4S
Con taco de multimaterial de alta calidad

SA-WH

Fijación de WC horizontal. 2 PCS x KIT



SANEAMIENTO



CÓDIGO	MEDIDA	€/KIT	KITS x
SAWHM06060	Ø6x60	5,457	50

TN4S
Con taco de multimaterial de alta calidad

SA-WHM

Fijación WC horizontal multiposición. 2 PCS x KIT



SANEAMIENTO



CÓDIGO	MEDIDA	€/100	KITS x
SATEB0860	Ø8x60	132,047	50
SATEB1080	Ø10x80	222,700	50

TN4S
Con taco de multimaterial de alta calidad

SA-TE TB

Fijación de termos y calentadores. Tornillo. 2 PCS x KIT



SANEAMIENTO



CÓDIGO	MEDIDA	€/100	KITS x
SATEA0865	Ø8x65	119,917	50
SATEA1075	Ø10x75	176,543	50

TN4S
Con taco de multimaterial de alta calidad

SA-TE AL

Fijación de termos y calentadores. Alcayata. 2 PCS x KIT



CO

Soporte para aire acondicionado

CO-SO

Juego soporte aire acondicionado. 2 PCS x KIT



SANEAMIENTO



CÓDIGO	MEDIDA	€/KIT	KITS x 
COSO15400	1,5 x 400	36,131	1
COSO15450	1,5 x 450	39,332	1
COSO15500	1,5 x 500	48,455	1
COSO20400	2 x 400	54,927	1
COSO20450	2 x 450	59,154	1
COSO20500	2 x 500	60,441	1



CO-KS

Kit silent block soporte AC. 4 PCS x KIT



SANEAMIENTO



CÓDIGO	MEDIDA	€/KIT	KITS x 
COKS08060	M8 x 60	8,151	1



VARILLA ROSCADA Y ACCESORIOS DE FIJACIÓN





RV

Varilla roscada

RV-ZN

METAL



Cincada. 1 metro



1 M.

CÓDIGO	MEDIDA	€/100	LONGITUD	PASO	
975ZM04	M4 x 1000	95,505	1.000	0.7	100
975ZM05	M5 x 1000	132,874	1.000	0.8	100
975ZM06	M6 x 1000	127,217	1.000	1	100
975ZM08	M8 x 1000	217,614	1.000	1.25	50
975ZM10	M10 x 1000	327,962	1.000	1.5	25
975ZM12	M12 x 1000	509,462	1.000	1.75	20
975ZM14	M14 x 1000	715,153	1.000	2	10
975ZM16	M16 x 1000	915,523	1.000	2	10
975ZM18	M18 x 1000	1.284,970	1.000	2.5	10
975ZM20	M20 x 1000	1.632,240	1.000	2.5	5
975ZM22	M22 x 1000	2.203,960	1.000	2.5	5
975ZM24	M24 x 1000	2.328,040	1.000	3	5
975ZM27	M27 x 1000	2.838,397	1.000	3	5
975ZM30	M30 x 1000	3.553,570	1.000	3.5	5
975ZM33	M33 x 1000	4.372,797	1.000	3.5	3
975ZM36	M36 x 1000	6.319,280	1.000	4	3

RV-ZN 8.8

METAL



Cincada. Calidad 8.8. 1 metro



1 M.

CÓDIGO	MEDIDA	€/100	LONGITUD	PASO	
9758ZM05	M5 x 1000	184,423	1.000	0.8	100
9758ZM06	M6 x 1000	189,687	1.000	1	100
9758ZM08	M8 x 1000	345,000	1.000	1.25	50
9758ZM10	M10 x 1000	534,813	1.000	1.5	25
9758ZM12	M12 x 1000	737,860	1.000	1.75	20
9758ZM14	M14 x 1000	1.042,697	1.000	2	10
9758ZM16	M16 x 1000	1.261,587	1.000	2	10
9758ZM18	M18 x 1000	1.726,993	1.000	2.5	5
9758ZM20	M20 x 1000	2.279,423	1.000	2.5	5
9758ZM22	M22 x 1000	2.915,833	1.000	2.5	5
9758ZM24	M24 x 1000	3.055,550	1.000	3	5
9758ZM27	M27 x 1000	3.801,180	1.000	3	5
9758ZM30	M30 x 1000	5.057,910	1.000	3.5	5
9758ZM33	M33 x 1000	6.428,013	1.000	3.5	3
9758ZM36	M36 x 1000	8.324,213	1.000	4	3

RV-A2

INOXIDABLE



Inoxidable A2. 1 metro



1 M.

CÓDIGO	MEDIDA	€/100	LONGITUD	PASO	
975A2M04	M4 x 1000	342,703	1.000	0.7	1
975A2M05	M5 x 1000	404,100	1.000	0.8	1
975A2M06	M6 x 1000	557,927	1.000	1	1
975A2M08	M8 x 1000	905,410	1.000	1.25	1
975A2M10	M10 x 1000	1.311,617	1.000	1.5	1
975A2M12	M12 x 1000	1.996,787	1.000	1.75	1
975A2M14	M14 x 1000	3.496,623	1.000	2	1
975A2M16	M16 x 1000	4.037,627	1.000	2	1
975A2M18	M18 x 1000	4.404,683	1.000	2.5	1
975A2M20	M20 x 1000	6.078,463	1.000	2.5	1
975A2M22	M22 x 1000	7.105,490	1.000	2.5	1
975A2M24	M24 x 1000	9.591,407	1.000	3	1
975A2M27	M27 x 1000	11.559,623	1.000	3	1
975A2M30	M30 x 1000	17.990,670	1.000	3.5	1
975A2M33	M33 x 1000	22.586,227	1.000	3.5	1
975A2M36	M36 x 1000	25.977,823	1.000	4	1



Varilla roscada RV



RV-2M

Cincada. 2 metros

CÓDIGO	MEDIDA	€/100	LONGITUD	PASO	
975ZM2M06	M6 x 2.000	254,433	2.000	1	50



Espárrago separador VR-SE



CÓDIGO	MEDIDA	€/100		
VRSE06020	M6 x 20	12,260	200	4,800
VRSE06030	M6 x 30	17,240	200	4,800
VRSE08020	M8 x 20	16,033	200	3,200
VRSE08030	M8 x 30	21,473	200	2,400
VRSE10030	M10 x 30	31,530	200	2,400
VRSE12030	M12 x 35	64,633	100	800



Manguito de unión MA



MA-HE

Hexagonal

CÓDIGO	MEDIDA	€/100	LONGITUD		
MAE0620	M6 x 20	19,567	20	200	2,400
MAE0630	M6 x 30	27,787	30	200	1,600
MAE0825	M8 x 25	22,507	25	200	1,600
MAE1030	M10 x 30	29,957	30	150	900
MAE1235	M12 x 35	69,900	35	100	600
MAE1650	M16 x 50	204,785	50	50	100
MAE2060	M20 x 60	559,053	60	25	-



Blíster

CÓDIGO	MEDIDA	€/BOLSA	PCS	BOLSAS
BZMAE0630	M6 x 30	2,561	6	15
BZMAE0825	M8 x 25	2,561	6	15
BZMAE1030	M10 x 30	2,561	4	15

Caja ventana

CÓDIGO	MEDIDA	€/CAJA	PCS	CAJAS
VMAE0630	M6 x 30	7,313	20	8
VMAE0825	M8 x 25	5,903	20	8
VMAE1030	M10 x 30	6,190	15	8

Bolsa autoservicio

CÓDIGO	MEDIDA	€/BOLSA	PCS	BOLSAS
LSMAE0630	M6 x 30	12,677	40	6
LSMAE0825	M8 x 25	7,747	30	5
LSMAE1030	M10 x 30	6,870	20	6



MA

Manguito de unión

MA-RE

Redondo



METAL



CÓDIGO	MEDIDA	€/100	LONGITUD		
MAR0420	M4 x 20	17,207	20	200	4.800
MAR5322	5/32W x 20	25,643	20	200	4.800
MAR0620	M6 x 20	18,153	20	200	2.400
MAR0630	M6 x 30	26,967	30	200	1.600
MAR0825	M8 x 25	22,507	25	200	2.400
MAR0830	M8 x 30	27,910	30	200	1.600
MAR1030	M10 x 30	29,787	30	150	900
MAR1235	M12 x 35	50,330	35	100	600
MAR1650	M16 x 50	179,630	50	50	300

Caja ventana

CÓDIGO	MEDIDA	€/CAJA	PCS	CAJAS
VMAR0420	M4 x 20	5,640	25	8
VMAR0630	M6 x 30	7,073	20	8
VMAR0830	M8 x 30	7,323	20	8
VMAR1030	M10 x 30	5,907	15	8

Bolsa autoservicio

CÓDIGO	MEDIDA	€/BOLSA	PCS	BOLSAS
LSMAR0420	M4 x 20	7,890	40	8
LSMAR0630	M6 x 30	12,377	40	7
LSMAR0830	M8 x 30	11,210	35	5
LSMAR1030	M10 x 30	6,893	20	6

MA-RI

Redondo. Inoxidable A2



INOXIDABLE



CÓDIGO	MEDIDA	€/100	LONGITUD	
MARI0830	M8 x 30	204,683	30	100
MARI1030	M10 x 30	281,790	30	100

MA-MH

Separador macho-hembra especial para cuadros eléctricos



METAL



CÓDIGO	MEDIDA	€/100	LONGITUD		
MAMH0610	M6 x 10	46,317	10	100	3.000
MAMH0620	M6 x 20	56,957	20	100	1.200
MAMH0630	M6 x 30	89,823	30	100	1.200
MAMH0640	M6 x 40	102,153	40	100	1.000
MAMH0650	M6 x 50	114,210	50	50	1.000



Tirafondo abrazadera y grapa

TAG

02 Info Técnica P. 273

SANEAMIENTO



AB-TA

Cincado. Ranurado

CÓDIGO	MEDIDA	€/100		
ABTA0630	M6 x 30	5,487	100	4,500
ABTA0640	M6 x 40	6,587	100	2,400
ABTA0650	M6 x 50	7,443	100	2,400
ABTA0730	M7 x 30	5,340	100	2,400
ABTA0740	M7 x 40	6,587	100	2,400
ABTA0750	M7 x 50	7,443	100	2,400
ABTA0760	M7 x 60	12,883	100	1,200
ABTA0770	M7 x 70	16,973	100	1,200
ABTA0780	M7 x 80	18,650	100	1,200
ABTA0840	M8 x 40	9,150	100	2,400
ABTA0860	M8 x 60	12,197	100	1,200
ABTA0880	M8 x 80	17,517	100	1,200
ABTA1050	M10 x 50	20,510	100	1,200
ABTA1070	M10 x 70	26,210	100	800
ABTA1090	M10 x 90	32,660	100	600



Bolsa autoservicio

CÓDIGO	MEDIDA	€/BOLSA	PCS	BOLSAS
LSABTA0630	M6 x 30	2,692	15	10
LSABTA0640	M6 x 40	2,856	15	10
LSABTA0650	M6 x 50	3,031	15	10
LSABTA0840	M8 x 40	3,626	15	10
LSABTA0860	M8 x 60	3,968	15	10

02 Info Técnica P. 274

SANEAMIENTO



AB-TA B

Bicromatado. Ranurado

CÓDIGO	MEDIDA	€/100		
ABTAB0630	M6 x 30	5,487	100	4,500
ABTAB0640	M6 x 40	6,587	100	2,400
ABTAB0650	M6 x 50	7,443	100	2,400



Bolsa autoservicio

CÓDIGO	MEDIDA	€/BOLSA	PCS	BOLSAS
LSABTAB0630	M6 x 30	2,692	15	10
LSABTAB0640	M6 x 40	2,856	15	10
LSABTAB0650	M6 x 50	3,031	15	10

02 Info Técnica P. 274

INOXIDABLE



AB-TA A2

Inoxidable A2

CÓDIGO	MEDIDA	€/100		
ABTA20630	M6 x 30	84,600	100	2,400





TAG

Tirafondo abrazadera y grapa

AB-TG

Tirafondo grapa. Huella combi



02 Info. Técnica
P. 274

SANEAMIENTO



CÓDIGO	MEDIDA	€/100		UD. MIN. VENTA		
ABTG4530	4,5 x 30	7,477	PZ2	200	100	4.500
ABTG4535	4,5 x 35	7,957	PZ2	200	100	4.500
ABTG4540	4,5 x 40	8,287	PZ2	200	100	2.400
ABTG5030	5 x 30	9,883	PZ3	200	100	2.400
ABTG5040	5 x 40	10,463	PZ3	200	100	2.400

TM-VR

Tornillo manguito para varilla roscada



SANEAMIENTO



CÓDIGO	MEDIDA	€/100		
TMVR06065	6 x 65	159,717	50	1.200
TMVR07065	7 x 65	167,330	50	1.200
TMVR08065	8 x 65	170,723	50	1.200

ES-DR

Espárrago de doble rosca

ES-DR

Cincado. TX



02 Info. Técnica
P. 275

SANEAMIENTO



CÓDIGO	MEDIDA	€/100	LLAVE DE INSTALACIÓN		
ESDR06040	M6 x 40	10,223	-	100	3.000
ESDR06050	M6 x 50	12,190	-	100	2.400
ESDR06060	M6 x 60	14,073	-	100	2.400
ESDR06070	M6 x 70	16,463	-	100	1.600
ESDR06080	M6 x 80	18,427	-	100	1.600
ESDR08050	M8 x 50	13,830	-	100	1.600
ESDR08060	M8 x 60	15,913	-	100	800
ESDR08070	M8 x 70	19,227	-	100	800
ESDR08080	M8 x 80	20,457	6	100	800
ESDR08090	M8 x 90	24,577	6	100	800
ESDR08100	M8 x 100	25,030	6	100	800
ESDR08110	M8 x 110	28,603	6	100	800
ESDR08120	M8 x 120	35,470	6	100	800
ESDR08130	M8 x 130	41,877	6	100	800
ESDR10080	M10 x 80	33,477	8	100	800
ESDR10100	M10 x 100	41,440	8	100	400
ESDR10110	M10 x 110	46,173	8	100	400
ESDR10120	M10 x 120	55,957	8	100	400
ESDR10130	M10 x 130	68,780	8	100	400
ESDR10140	M10 x 140	73,197	8	100	400
ESDR10150	M10 x 150	77,463	8	100	400
ESDR10180	M10 x 180	104,680	8	100	300
ESDR10200	M10 x 200	116,377	8	100	200

Bolsa autoservicio

CÓDIGO	MEDIDA	€/BOLSA	PCS	BOLSAS
LESDR06080	M6 x 80	5,239	25	7
LESDR08060	M8 x 60	5,371	25	7
LESDR08080	M8 x 80	6,658	25	6
LESDR08100	M8 x 100	7,849	25	6
LESDR08120	M8 x 120	7,981	20	6
LESDR10080	M10 x 80	7,545	20	6
LESDR10100	M10 x 100	8,203	18	6
LESDR10120	M10 x 120	8,670	15	7



Espárrago de doble rosca

ES-DR



INOXIDABLE



ES-DA2

Inoxidable A2. TX

CÓDIGO	MEDIDA	€/100	LLAVE DE INSTALACIÓN		
ESDA208060	M8 x 60	131,207	6	100	800
ESDA210060	M10 x 60	221,897	8	100	800



Taco de latón para fijaciones ligeras en materiales macizos

TALA



MACIZOS

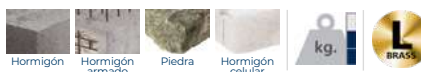

CÓDIGO	MEDIDA	€/100	Ø BROCA		
TALAM04	M4 x 16 Ø5	13,400	5	300	9.600
TALAM05	M5 x 18 Ø6	21,867	6	200	6.400
TALA532	W5/32 x 16 Ø5	13,400	5	300	9.600
TALAM06	M6 x 23 Ø8	30,150	8	200	4.800
TALAM08	M8 x 28 Ø10	54,127	10	100	2.400
TALAM10	M10 x 33 Ø12	84,557	12	150	1.800
TALAM12	M12 x 38 Ø15	181,940	15	150	900



CÓDIGO	MEDIDA	€/BOLSA	PCS B	BOLSAS
BZTALAM06	M6 x 23 Ø8	3,350	4	20
BZTALAM08	M8 x 28 Ø10	3,350	4	20
BZTALAM10	M10 x 33 Ø12	3,350	2	15

CÓDIGO	MEDIDA	€/CAJA	PCS	CAJAS
VTALAM06	M6 x 23 Ø8	8,658	25	8
VTALAM08	M8 x 28 Ø10	9,193	15	8
VTALAM10	M10 x 33 Ø12	14,488	15	8

CÓDIGO	MEDIDA	€/BOLSA	PCS	BOLSAS
LSTALAM06	M6 x 23 Ø8	15,580	50	8
LSTALAM08	M8 x 28 Ø10	16,555	30	7
LSTALAM10	M10 x 33 Ø12	21,727	25	5

Taco de expansión metálico

TA-ME



MACIZOS



CÓDIGO	MEDIDA	€/100	Ø BROCA	UD. MIN. VENTA		
TAME05030	M5 x 30 Ø5	15,297	5	200	100	4.500
TAME06032	M6 x 32 Ø6	17,167	6	200	100	2.400
TAME08038	M8 x 38 Ø8	28,467	8	200	100	1.200
TAME08060	M8 x 60 Ø8	39,390	8	100	50	600
TAME10060	M10 x 60 Ø10	45,820	10	50	50	600



CÓDIGO	MEDIDA	€/BOLSA	PCS B	BOLSAS
BZTAME06032	M6 x 32 Ø6	3,350	4	20
BZTAME08038	M8 x 38 Ø8	3,350	4	20
BZTAME08060	M8 x 60 Ø8	3,350	4	20
BZTAME10060	M10 x 60 Ø10	3,350	4	20

TC-MA

Taco clavable metálico con punta de acero

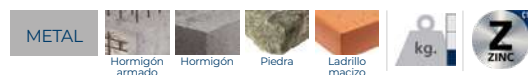

CÓDIGO	MEDIDA	€/100	Ø BROCA		
TCMA05022	5 x 22 Ø5	16,953	5	100	2.400
TCMA06030	6 x 30 Ø6	25,407	6	100	2.400
TCMA06040	6 x 40 Ø6	28,523	6	100	1.200
TCMA06050	6 x 50 Ø6	32,803	6	100	1.200

HE

Anclaje hembra con cono interior para grandes cargas

HE-HO

Cincado. Homologado ETE Opt.7 y para aplicaciones no estructurales

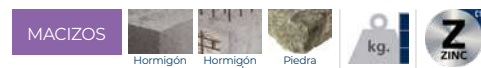

CÓDIGO	MEDIDA	€/100	LONGITUD		
HEHOM06	M6 x 25 Ø8	19,523	25	100	3.200
HEHOM08	M8 x 30 Ø10	24,393	30	100	1.600
HEHOM10	M10 x 40 Ø12	39,667	40	50	800
HEHOM12	M12 x 50 Ø15	72,920	50	50	400
HEHOM12D	M12 x 50 Ø16	85,110	50	50	400
HEHOM16	M16 x 65 Ø20	199,647	65	25	200
HEHOM20	M20 x 80 Ø25	435,603	80	25	100



HE-A4

Inoxidable A4. Homologado ETE Aplicaciones no estructurales

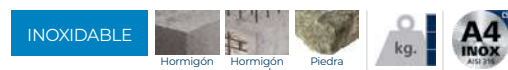

CÓDIGO	MEDIDA	€/100	LONGITUD		
HEA4M06	M6 x 25 Ø8	113,850	25	100	4.000
HEA4M08	M8 x 30 Ø10	162,337	30	100	1.600
HEA4M10	M10 x 40 Ø12	243,967	40	50	800
HEA4M12	M12 x 50 Ø15	485,740	50	50	600
HEA4M16	M16 x 65 Ø20	1.031,163	65	25	250
HEA4M20	M20 x 80 Ø25	1.784,273	80	25	100



HE-CL

Con collarín. Cincado. Homologado ETE Opt.7 y para aplicaciones no estructurales

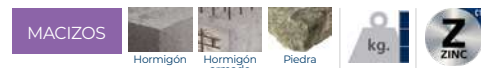

CÓDIGO	MEDIDA	€/100	LONGITUD		
HECLOM06	M6 x 25 Ø8	23,090	25	100	3.200
HECLOM08	M8 x 30 Ø10	30,733	30	100	1.600
HECLOM10	M10 x 40 Ø12	48,047	40	50	800
HECLOM12	M12 x 50 Ø15	87,197	50	50	400
HECLOM12D	M12 x 50 Ø16	99,787	50	50	400
HECLOM16	M16 x 65 Ø20	245,097	65	25	200





Anclaje hembra con cono interior para grandes cargas

HE

Info Técnica
P. 277

INOXIDABLE



CÓDIGO	MEDIDA	€/100	LONGITUD		
HEC4M06	M6 x 25 Ø8	149,077	25	100	3.200
HEC4M08	M8 x 30 Ø10	213,453	30	100	1.600
HEC4M10	M10 x 40 Ø12	329,780	40	50	800
HEC4M12	M12 x 50 Ø15	592,930	50	50	400

HE-C4

Con collarín. Inoxidable A4. Homologado ETE Aplicaciones no estructurales



Info Técnica
P. 277

MACIZOS



CÓDIGO	MEDIDA	€/100	LONGITUD		
HENOM06	M6 x 25 Ø8	15,020	25	100	4.000
HENOM08	M8 x 30 Ø10	20,743	30	100	2.200
HENOM10	M10 x 40 Ø12	34,687	40	50	1.000
HENOM12	M12 x 50 Ø15	63,763	50	50	600
HENOM16	M16 x 65 Ø20	160,683	65	25	250
HENOM20	M20 x 80 Ø25	300,743	80	25	100

HE-NO

Cincado



Blíster

CÓDIGO	MEDIDA	€/BOLSA	PCS	BOLSAS
BZHENOM06	M6 x 25 Ø8	3,350	4	20
BZHENOM08	M8 x 30 Ø10	3,350	4	20
BZHENOM10	M10 x 40 Ø12	3,350	2	15

Caja ventana

CÓDIGO	MEDIDA	€/CAJA	PCS	CAJAS
VHENOM06	M6 x 25 Ø8	3,560	15	8
VHENOM08	M8 x 30 Ø10	4,346	15	8

Bolsa autoservicio

CÓDIGO	MEDIDA	€/BOLSA	PCS	BOLSAS
LSHENOM06	M6 x 25 Ø8	5,907	30	7
LSHENOM08	M8 x 30 Ø10	7,602	30	7
LSHENOM10	M10 x 40 Ø12	7,301	16	7

MACIZOS



CÓDIGO	MEDIDA	€/100	
HEHCSDS08	Ø10 x 28	15,321	1
HEHCSDS10	Ø12 x 28	19,134	1
HEHCSDS12	Ø15 x 29	24,856	1

HE-HC SDS **NEW**

Broca SDS con tope para HE-HC



MACIZOS

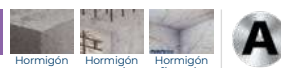

CÓDIGO	MEDIDA	€/100	
HEHOSDS06	Ø8 x 27	13,419	1
HEHOSDS08	Ø10 x 33	15,321	1
HEHOSDS10	Ø12 x 43	19,134	1
HEHOSDS12	Ø15 x 54	24,863	1

HE-HO SDS **NEW**

Broca SDS con tope para HE-HO





AB-F

Florón para abrazaderas

AB-FP

Florón plano para abrazaderas



SANEAMIENTO



CÓDIGO	MEDIDA	€/100		
ABFP25	25	7,023	100	2.400
ABFP32	32	10,330	100	2.400

AB-FC

Florón cónico para abrazaderas



SANEAMIENTO



CÓDIGO	MEDIDA	€/100		
ABFC09	9	11,393	100	2.400
ABFC14	14	17,757	100	1.200
ABFC19	19	28,317	100	1.200

TAG

Tirafondo abrazadera y grapa

AB-TR

Tornillo doble para abrazaderas



SANEAMIENTO



CÓDIGO	MEDIDA	€/100		
ABTR05030	M5 x 30	10,850	100	2.400
ABTR05040	M5 x 40	11,237	100	2.400
ABTR05050	M5 x 50	12,523	100	2.400
ABTR05060	M5 x 60	14,837	100	1.200
ABTR06040	M6 x 40	14,337	100	2.400
ABTR06050	M6 x 50	17,387	100	1.200
ABTR06060	M6 x 60	19,967	100	1.200

AB-PM7

Prolongador cilíndrico para abrazaderas M7



SANEAMIENTO



CÓDIGO	MEDIDA	€/100		
ABPM720	20	112,693	50	2.250
ABPM730	30	147,677	50	2.250
ABPM740	40	166,307	50	1.200

Pletina de fijación



PF

METAL



PF-ZN

Cincada

CÓDIGO	MEDIDA	€/100		
PFZNM0800	M8	55,630	100	600
PFZNM0810	M8 + M10	69,940	100	600
PFZNM1000	M10	67,283	100	600





INOXIDABLE



PF-A4

Inoxidable A4

CÓDIGO	MEDIDA	€/100		
PFA4M0800	M8	303,137	100	600
PFA4M0810	M8 + M10	361,303	100	600
PFA4M1000	M10	346,320	100	600





FIJACIONES PLÁSTICAS Y PARA MATERIALES HUECOS



T-NUX

Los tacos de nylon universales de alto rendimiento para uso en hormigón y mampostería, son una solución polivalente y profesional. Permiten su instalación con las máximas garantías de seguridad gracias a que cuentan con homologación ETE y a resistencia a fuego.

Su diseño permite que el taco logre adaptarse a cualquier tipo de material base, ya sea en material sólido o hueco. Además, posibilita que la carga se distribuya a lo largo de todo el taco, gracias a una expansión controlada en distintos puntos del material donde se instala.



DISEÑO Y GEOMETRÍA

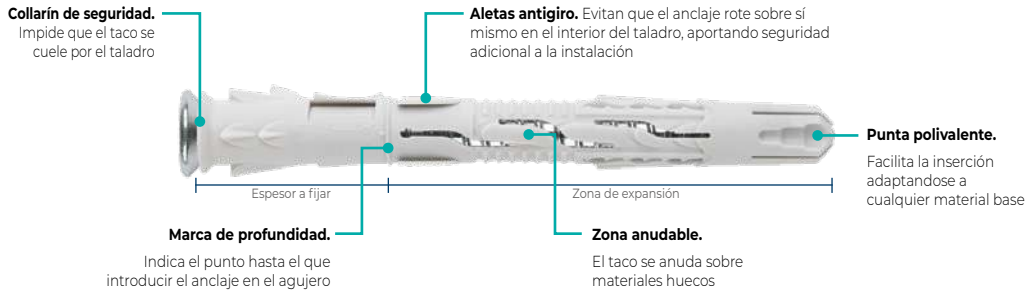

APLICACIONES

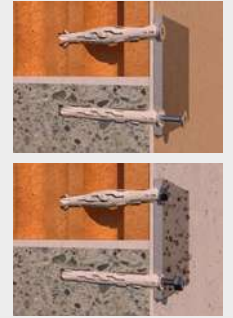

- Fijación de marcos de ventanas y puertas.
- Puertas de garajes.
- Barandillas.
- Balaustradas.
- Fijación de rejillas.
- Rehabilitación de fachadas.
- Fijación de subestructuras metálicas para fachadas ventiladas.
- Usos exteriores e interiores.
- Fijación de aplacados de piedra para revestimientos de fachada.

CUALIDADES Y VENTAJAS



MÁXIMA VERSATILIDAD. MULTIMATERIAL.

Su diseño permite que el taco logre adaptarse a cualquier tipo de material base, ya sea en materiales macizos o huecos. Especialmente apto para cuando se desconozca el material base donde se realiza la fijación.

MÁXIMAS GARANTÍAS. PRODUCTOS HOMOLOGADOS ACORDE A LOS MÁS ALTOS ESTÁNDARES DE CALIDAD.

- Homologado (ETA 14/0467) para usos no estructurales en hormigón, hormigón aireado, ladrillo macizo, ladrillo hueco y bloque de hormigón (en las medidas Ø8 y Ø10)
- Homologado a resistencia a fuego R30-R120 en hormigón



*El anclaje está homologado cuando se utiliza el taco y el tornillo en su conjunto, no por separado. Utilizar anclajes homologados aporta seguridad y calidad al anclaje cumpliendo los más altos estándares de calidad.



PRODUCTO DE CALIDAD

El anclaje T-NUX está compuesto de dos elementos de máxima calidad, un taco de nylon de Poliamida 6 y un tornillo (ver diferentes alternativas en la gama. También disponible el taco suelto).



MÁXIMAS PRESTACIONES

La geometría del taco permite que al introducir el tornillo, el taco expanda de una manera uniforme y permita una fijación con unas altas prestaciones de hasta 202 Kg por anclaje (consultar ficha técnica).

FABRICACIÓN 100% INDEX

Esto nos permite asegurar un riguroso control de los procesos, garantizar la máxima calidad en nuestros productos, brindar el mejor servicio y obtener un coste global competitivo.

GAMA



PRODUCTO	T-NUX A	T-NUX A A4	T-NUX E	T-NUX E A4	T-NUX T	T-FUX E	T-NUX
CABEZA DEL TORNILLO	Avellanada	Avellanada	Hexagonal	Hexagonal	Truss inviolable	Hexagonal sin arandela	Espárrago
RECUBRIMIENTO/MATERIAL DEL TORNILLO	Z	A4 INOX	Z	A4 INOX	Z	Z	-
TIPO DE CABEZA DEL TACO							
CE	✓	✓	✓	✓	✓	✓	
FIRE RESISTANCE	✓	✓	✓	✓	✓	✓	

EL RECUBRIMIENTO PERFECTO SEGÚN EL NIVEL DE CORROSIÓN



Material Inoxidable A4: válido para interior y exterior, en zonas costeras o industriales, zonas expuestas a alta contaminación o zonas cercanas a carreteras.



Recubrimiento Cincado: apto para uso en condiciones interiores secas (categoría C1 según la norma ISO 923), por un periodo de 50 años.



Taco de nylon universal de alto rendimiento

T-NUX



MULTIMATERIAL

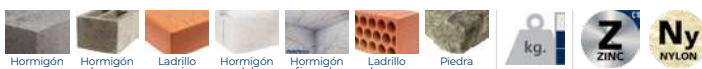

CÓDIGO	MEDIDA	€/100		ESPESOR MÁX. A FIJAR		
• TNUXA08060	8 x 60 Ø8	52,810	TX30	10	50	600
• TNUXA08080	8 x 80 Ø8	57,803	TX30	10	50	600
• TNUXA08100	8 x 100 Ø8	72,260	TX30	30	50	600
• TNUXA08120	8 x 120 Ø8	82,623	TX30	50	50	300
• TNUXA10060	10 x 60 Ø10	78,270	TX40	10	50	300
TNUXA10080	10 x 80 Ø10	96,223	TX40	10	50	300
TNUXA10100	10 x 100 Ø10	108,720	TX40	30	50	300
TNUXA10120	10 x 120 Ø10	131,847	TX40	50	50	300
TNUXA10140	10 x 140 Ø10	155,620	TX40	70	50	300
TNUXA10160	10 x 160 Ø10	166,097	TX40	90	50	200
TNUXA10180	10 x 180 Ø10	226,933	TX40	110	50	150
TNUXA10200	10 x 200 Ø10	275,113	TX40	130	50	150
TNUXA10230	10 x 230 Ø10	320,800	TX40	160	50	100

• Medidas sin homologar
• Medida sin homologar para fuego

Blíster

CÓDIGO	MEDIDA	€/BOLSA	PCS	BOLSAS
BZTNXA08080	8 x 80 Ø8	3,350	2	15
BZTNXA08100	8 x 100 Ø8	3,350	2	15
BZTNXA08120	8 x 120 Ø8	3,350	2	15
BZTNXA10080	10 x 80 Ø10	3,350	2	15
BZTNXA10100	10 x 100 Ø10	3,350	2	15
BZTNXA10120	10 x 120 Ø10	3,350	2	15

Caja ventana

CÓDIGO	MEDIDA	€/CAJA	PCS	CAJAS
VTNUXA08080	8 x 80 Ø8	5,741	8	8
VTNUXA08100	8 x 100 Ø8	7,176	8	8
VTNUXA10080	10 x 80 Ø10	9,551	8	8
VTNUXA10100	10 x 100 Ø10	10,795	8	8

Bolsa autoservicio

CÓDIGO	MEDIDA	€/BOLSA	PCS	BOLSAS
LSTNXA08080	8 x 80 Ø8	6,713	10	8
LSTNXA08100	8 x 100 Ø8	7,996	10	8
LSTNXA08120	8 x 120 Ø8	8,800	8	8
LSTNXA10080	10 x 80 Ø10	9,462	8	8
LSTNXA10100	10 x 100 Ø10	7,217	6	6

T-NUX A

Cabeza avellanada. Huella TX. Cincado. Homologado ETE



Disponible en varios recubrimientos. Consulte precio y plazo de entrega.



INOXIDABLE

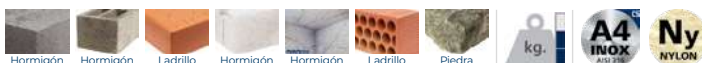

CÓDIGO	MEDIDA	€/100		ESPESOR MÁX. A FIJAR		
• TNXA408080	8 x 80 Ø8	283,350	TX30	10	50	600
• TNXA408100	8 x 100 Ø8	341,673	TX30	30	50	600
• TNXA408120	8 x 120 Ø8	422,090	TX30	50	50	300
TNXA410080	10 x 80 Ø10	360,653	TX40	10	50	300
TNXA410100	10 x 100 Ø10	430,607	TX40	30	50	300
TNXA410120	10 x 120 Ø10	501,470	TX40	50	50	300
TNXA410140	10 x 140 Ø10	594,653	TX40	70	50	300

• Medida sin homologar para fuego

T-NUX A A4

Inoxidable A4. Cabeza avellanada. Huella TX. Homologado ETE



MULTIMATERIAL

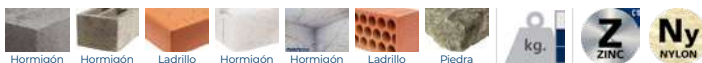

CÓDIGO	MEDIDA	€/100	N° HUELLA	ESPESOR MÁX. A FIJAR		
• TNUXE08060	8 x 60 Ø8	60,733	SW10/TX30	10	50	600
• TNUXE08080	8 x 80 Ø8	69,213	SW10/TX30	10	50	600
• TNUXE08100	8 x 100 Ø8	87,433	SW10/TX30	30	50	300
• TNUXE08120	8 x 120 Ø8	102,390	SW10/TX30	50	50	300
• TNUXE10060	10 x 60 Ø10	89,460	SW13/TX40	10	50	300
TNUXE10080	10 x 80 Ø10	105,487	SW13/TX40	10	50	300
TNUXE10100	10 x 100 Ø10	128,757	SW13/TX40	30	50	300
TNUXE10120	10 x 120 Ø10	163,200	SW13/TX40	50	50	300
TNUXE10140	10 x 140 Ø10	208,273	SW13/TX40	70	50	200
TNUXE10160	10 x 160 Ø10	208,763	SW13/TX40	90	50	150
TNUXE10180	10 x 180 Ø10	251,580	SW13/TX40	110	50	150
TNUXE10200	10 x 200 Ø10	332,737	SW13/TX40	130	50	150
TNUXE10230	10 x 230 Ø10	405,467	SW13/TX40	160	50	100

• Medidas sin homologar
• Medida sin homologar para fuego

Blíster

CÓDIGO	MEDIDA	€/BOLSA	PCS	BOLSAS
BZTNXE08080	8 x 80 Ø8	3,350	2	15
BZTNXE08100	8 x 100 Ø8	3,350	2	15
BZTNXE08120	8 x 120 Ø8	3,350	2	15
BZTNXE10080	10 x 80 Ø10	3,350	2	15
BZTNXE10100	10 x 100 Ø10	3,350	2	15
BZTNXE10120	10 x 120 Ø10	3,350	2	15

Caja ventana

CÓDIGO	MEDIDA	€/CAJA	PCS	CAJAS
VTNUXE08080	8 x 80 Ø8	6,875	8	8
VTNUXE08100	8 x 100 Ø8	8,680	8	8
VTNUXE10080	10 x 80 Ø10	10,475	8	8
VTNUXE10100	10 x 100 Ø10	12,141	8	8

Bolsa autoservicio

CÓDIGO	MEDIDA	€/BOLSA	PCS	BOLSAS
LSTNXE08080	8 x 80 Ø8	7,654	10	8
LSTNXE08100	8 x 100 Ø8	9,671	10	8
LSTNXE08120	8 x 120 Ø8	10,152	8	8
LSTNXE10080	10 x 80 Ø10	7,002	6	6
LSTNXE10100	10 x 100 Ø10	8,123	6	6

T-NUX E

Cabeza hexagonal. Huella TX. Cincado. Homologado ETE



Disponible en varios recubrimientos. Consulte precio y plazo de entrega.

T-NUX

Taco de nylon universal de alto rendimiento

T-NUX E A4

Inoxidable A4. Cabeza hexagonal. Huella TX. Homologado ETE



02 P. 278 Info. Técnica

INOXIDABLE



CÓDIGO	MEDIDA	€/100	Nº HUELLA	ESPESOR MÁX. A FIJAR		
• TNXE408080	8 x 80 Ø8	397,757	SW10/TX30	10	50	600
• TNXE408100	8 x 100 Ø8	471,447	SW10/TX30	30	50	300
TNXE410080	10 x 80 Ø10	527,587	SW13/TX40	10	50	300
TNXE410100	10 x 100 Ø10	550,990	SW13/TX40	30	50	300
TNXE410120	10 x 120 Ø10	662,293	SW13/TX40	50	50	300
TNXE410140	10 x 140 Ø10	772,567	SW13/TX40	70	50	200

• Medida sin homologar para fuego

T-NUX T

Cabeza Truss inviolable. Huella TX. Cincado. Homologado ETE



Disponible en varios recubrimientos. Consulte precio y plazo de entrega.

02 P. 279 Info. Técnica

MULTIMATERIAL



CÓDIGO	MEDIDA	€/100		ESPESOR MÁX. A FIJAR		
TNuxt10080	10 x 80 Ø10	108,730	TX40	10	50	300
TNuxt10100	10 x 100 Ø10	122,857	TX40	30	50	300
TNuxt10120	10 x 120 Ø10	144,287	TX40	50	50	200
TNuxt10140	10 x 140 Ø10	179,267	TX40	70	50	200
TNuxt10160	10 x 160 Ø10	191,337	TX40	90	50	200

T-FUX E

Taco cabeza cilíndrica. Tornillo cabeza hexagonal. Huella TX. Cincado. Homologado ETE



02 P. 279 Info. Técnica

MULTIMATERIAL



CÓDIGO	MEDIDA	€/100		ESPESOR MÁX. A FIJAR		
• TFUXE10080	10 x 80 Ø10	117,777	SW13/TX40	10	50	300
TFUXE10100	10 x 100 Ø10	136,577	SW13/TX40	30	50	200
TFUXE10120	10 x 120 Ø10	178,293	SW13/TX40	50	50	200

• Medida sin homologar para fuego

T-NUX

Taco de nylon



MULTIMATERIAL



CÓDIGO	MEDIDA	€/100	ESPESOR MÁX. A FIJAR		
TNux08060	8 x 60	25,573	-	50	800
TNux08080	8 x 80	27,580	-	50	600
TNux08100	8 x 100	31,790	-	50	600
TNux08120	8 x 120	35,060	-	50	600
TNux10060	10 x 60	32,963	-	50	600
TNux10080	10 x 80	33,423	-	50	600
TNux10100	10 x 100	40,677	-	50	600
TNux10120	10 x 120	47,917	-	50	600
TNux10140	10 x 140	62,407	-	50	300



Taco clavable de poliamida 6.6, premontado con tornillo rosca-arpón

TCA



MULTIMATERIAL

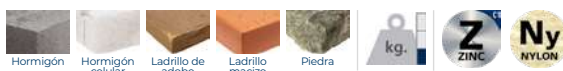

TC-CA

Taco con cabeza avellanada

CÓDIGO	MEDIDA	€/100	⊕	ESPESOR MÁX. A FIJAR	UD. MIN. VENTA		
TCCA05025	5 x 25 Ø5	7,613	PZ2	5	400	100	2.400
TCCA05030	5 x 30 Ø5	7,960	PZ2	5	400	100	2.400
TCCA05035	5 x 35 Ø5	9,000	PZ2	10	400	100	2.400
TCCA05050	5 x 50 Ø5	10,170	PZ2	25	200	100	1.200
TCCA06035	6 x 35 Ø6	9,813	PZ2	10	400	100	1.200
TCCA06040	6 x 40 Ø6	9,903	PZ2	10	400	100	1.200
TCCA06050	6 x 50 Ø6	12,020	PZ2	20	200	100	1.200
TCCA06060	6 x 60 Ø6	14,073	PZ2	30	200	100	1.200
TCCA06070	6 x 70 Ø6	17,383	PZ2	40	200	100	1.200
TCCA06080	6 x 80 Ø6	18,933	PZ2	50	200	100	1.200
TCCA08060	8 x 60 Ø8	21,203	PZ3	20	200	100	600
TCCA08080	8 x 80 Ø8	26,850	PZ3	40	200	100	600
TCCA08100	8 x 100 Ø8	32,830	PZ3	60	100	100	600
TCCA08120	8 x 120 Ø8	39,720	PZ3	80	100	100	400
TCCA08140	8 x 140 Ø8	49,863	PZ3	100	100	100	300



TAMBIÉN DISPONIBLE EN
easykits



Blíster

Caja ventana

Bolsa autoservicio

CÓDIGO	MEDIDA	€/BOLSA	PCS B	BOLSAS
BZTCCA05030	5 x 30 Ø5	2,561	4	20
BZTCCA05050	5 x 50 Ø5	2,561	4	20
BZTCCA06040	6 x 40 Ø6	2,561	4	20
BZTCCA06050	6 x 50 Ø6	2,561	4	20
BZTCCA06060	6 x 60 Ø6	2,561	4	20
BZTCCA06070	6 x 70 Ø6	2,561	4	20
BZTCCA08060	8 x 60 Ø8	2,561	4	20
BZTCCA08080	8 x 80 Ø8	2,561	4	20
BZTCCA08100	8 x 100 Ø8	2,561	2	20
BZTCCA08120	8 x 120 Ø8	2,561	2	20

CÓDIGO	MEDIDA	€/CAJA	PCS	CAJAS
VTCCA05025	5 x 25 Ø5	3,260	30	8
VTCCA05030	5 x 30 Ø5	3,423	30	8
VTCCA05035	5 x 35 Ø5	3,773	30	8
VTCCA05050	5 x 50 Ø5	4,167	30	8
VTCCA06035	6 x 35 Ø6	4,017	30	8
VTCCA06040	6 x 40 Ø6	4,123	30	8
VTCCA06050	6 x 50 Ø6	4,527	30	8
VTCCA06060	6 x 60 Ø6	4,670	25	8
VTCCA06070	6 x 70 Ø6	5,767	25	8
VTCCA08060	8 x 60 Ø8	5,610	20	8
VTCCA08080	8 x 80 Ø8	7,163	20	8

CÓDIGO	MEDIDA	€/BOLSA	PCS	BOLSAS
LSTCCA05025	5 x 25 Ø5	3,480	30	10
LSTCCA05030	5 x 30 Ø5	3,670	30	8
LSTCCA05035	5 x 35 Ø5	3,907	30	7
LSTCCA05050	5 x 50 Ø5	4,393	30	7
LSTCCA06035	6 x 35 Ø6	4,360	30	7
LSTCCA06040	6 x 40 Ø6	4,410	30	6
LSTCCA06050	6 x 50 Ø6	4,540	25	6
LSTCCA06060	6 x 60 Ø6	5,227	25	6
LSTCCA06070	6 x 70 Ø6	5,710	25	6
LSTCCA08060	8 x 60 Ø8	5,667	20	6
LSTCCA08080	8 x 80 Ø8	7,097	20	6

MULTIMATERIAL

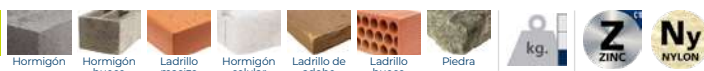

TC-CA EP

Bote de plástico

CÓDIGO	MEDIDA	€/PC	⊕	ESPESOR MÁX. A FIJAR	UD. MIN. VENTA	
TCCAEP5030	5 x 30 Ø5	55,727	PZ3	5	2	1
TCCAEP6040	6 x 40 Ø6	46,647	PZ3	10	2	1



TC-SP

Taco clavable de alta expansión

TC-SP

Taco con cabeza avellanada



02
P. 279 Info
Técnica

MULTIMATERIAL

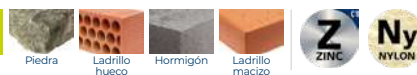

CÓDIGO	MEDIDA	€/100	Nº HUELLA	ESPESOR MÁX. A FIJAR		
TCSPO5027	5 x 27	8,980	PZ2	5	100	2.400
TCSPO6032	6 x 32	10,567	PZ2	5	100	1.200
TCSPO6040	6 x 40	10,950	PZ2	10	100	1.200

TC-SP EP

Bote de plástico



MULTIMATERIAL

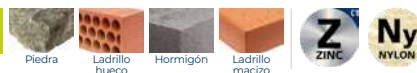

CÓDIGO	MEDIDA	€/PC	Nº HUELLA	ESPESOR MÁX. A FIJAR	
TCSPEP05027	5 x 27	65,249	PZ2	5	1
TCSPEP06032	6 x 32	51,246	PZ2	5	1
TCSPEP06040	6 x 40	52,921	PZ2	10	1

TN4S

Los tacos de nylon anudables TN4S de INDEX, ofrecen unas máximas prestaciones gracias a su expansión en 4 direcciones. Destacan por su versatilidad en la instalación, siendo aptos para su aplicación tanto en materiales macizos (hormigón, ladrillo macizo), como en materiales huecos (ladrillo hueco, bloques de hormigón hueco, placa yeso). Pueden llegar a soportar cargas de más de 600 kg por punto de apoyo. Están fabricados con Nylon® de alta calidad (poliamida 6).



CUALIDADES Y VENTAJAS



MÁXIMAS PRESTACIONES

Expande en 4 direcciones, lo que garantiza una perfecta adherencia sobre el material base. En los materiales huecos, al introducir el tornillo/tirafondo, el taco se anuda retrayéndose y presionando sobre el material base y permitiendo un correcto agarre.



MULTIMATERIAL

Recomendado tanto para materiales base macizos (hormigón, piedra, ladrillo macizo, ladrillo de adobe, hormigón celular), como huecos (ladrillo hueco, bloque hueco, placa de yeso laminado, placas alveolares).



VERSATILIDAD

Recomendable para utilizar con una amplia gama de tornillos (tornillos con rosca aglomerada, tornillos avellanados, tornillos barraqueros...), así como otro tipo de productos (alcayatas o hembrillas).



FACILIDAD DE USO

El collarín evita que el taco se cuele en el interior del material base durante la instalación. El taco dispone de varios anti-giros laterales que ayudan a que el taco no gire al introducir el tornillo/tirafondo.

APLICACIONES



- Verjas
- Barandillas
- Soportes
- Estanterías
- Rótulos
- Sanitarios y/o instalaciones de baños
- Cuadros
- Elementos ligeros
- Iluminación
- Rodapiés
- Buzones
- Muebles de TV
- Canaletas eléctricas
- Muebles

Taco de nylon anudable de 4 segmentos para todo tipo de materiales

TN4S



MULTIMATERIAL



TN4S

Taco

CÓDIGO	MEDIDA	€/100	MEDIDA TORNILLO		
TN4S05	5 x 25 Ø5	3,623	TPPO 3-4	100	4.200
TN4S06	6 x 30 Ø6	3,790	TPPO 4-5	100	3.200
TN4S08	8 x 40 Ø8	5,940	TPPO 4,5, TB 5-6	100	1.600
TN4S10	10 x 50 Ø10	10,667	TB 6-8	50	800
TN4S12	12 x 60 Ø12	21,577	TB 8-10	25	400
TN4S14	14 x 70 Ø14	28,040	TB 10-12	20	320



CÓDIGO	MEDIDA	€/BOLSA	PCS BOLSAS	BOLSAS
BZTN4S05	5 x 25 Ø5	2,561	25	15
BZTN4S06	6 x 30 Ø6	2,561	25	15
BZTN4S08	8 x 40 Ø8	2,561	15	10
BZTN4S10	10 x 50 Ø10	2,561	10	10
BZTN4S12	12 x 60 Ø12	2,561	6	10



MULTIMATERIAL



TN4S EP

Bote de plástico

CÓDIGO	MEDIDA	€/PC	MEDIDA TORNILLO	
TN4S06EP	6 x 30 Ø6	34,854	TPPO 4-5	1
TN4S08EP	8 x 40 Ø8	27,590	TPPO 4,5, TB 5-6	1
TN4S10EP	10 x 50 Ø10	29,434	TB 6-8	1



TN4S

Taco de nylon anudable de 4 segmentos para todo tipo de materiales

NEW TN4S-A

Taco con collarín



MULTIMATERIAL



CÓDIGO	MEDIDA	€/100	MEDIDA TORNILLO		
TN4SA06	6	4,563	TPPO 3,5-4	100	2.400

NEW TN4S-A EP

Taco con collarín. Bote de plástico



MULTIMATERIAL



CÓDIGO	MEDIDA	€/PC	MEDIDA TORNILLO		
TN4SA06EP	6	41,978	TPPO 4-5	1	-

TACON

Taco de nylon

TACON

Taco



02 Info. Técnica P. 280

MULTIMATERIAL



CÓDIGO	MEDIDA	€/100	MEDIDA TORNILLO		
TACON04	4 x 20 Ø4	3,023	TPPO 2,5-3	100	8.000
TACON05	5 x 25 Ø5	2,183	TPPO 2,5-4	100	8.000
TACON06	6 x 30 Ø6	2,240	TPPO 3,5-4	100	9.000
TACON07	7 x 30 Ø7	4,677	TPPO 4-4,5	100	5.000
TACON08	8 x 40 Ø8	4,413	TPPO 4,5, TB 5-6	100	5.000
TACON10	10 x 50 Ø10	7,437	TB 6-8	50	2.500
TACON12	12 x 60 Ø12	13,630	TB 8-10	25	1.250
TACON14	14 x 70 Ø14	22,033	TB 10-12	20	1.000
TACON16	16 x 80 Ø16	124,900	TB 12-14	10	500

Blíster

CÓDIGO	MEDIDA	€/BOLSA	PCS	BOLSAS
BZTACON04	4 x 20 Ø4	2,024	25	15
BZTACON05	5 x 25 Ø5	2,024	25	15
BZTACON06	6 x 30 Ø6	2,024	25	15
BZTACON08	8 x 40 Ø8	2,024	15	10
BZTACON10	10 x 50 Ø10	2,024	10	10
BZTACON12	12 x 60 Ø12	2,024	5	10

TACOL

Taco con collarín



02 Info. Técnica P. 280

MULTIMATERIAL



CÓDIGO	MEDIDA	€/100	MEDIDA TORNILLO		
TACOL05	5 x 25 Ø5	2,747	TPPO 2,5-4	100	8.000
TACOL06	6 x 30 Ø6	2,343	TPPO 3,5-4	100	9.000
TACOL08	8 x 40 Ø8	4,743	TPPO 4,5, TB 5-6	100	5.000
TACOL10	10 x 50 Ø10	8,940	TB 6-8	50	2.500
TACOL12	12 x 60 Ø12	17,983	TB 8-10	25	1.250



Taco de nylon

TACON



MULTIMATERIAL



CÓDIGO	MEDIDA	€/100	MEDIDA TORNILLO		
TACOLA06	6 x 30 Ø6	2,723	TPPO 3,5-4	100	2.400

TACOL-A

Taco de nylon con collarín ancho



Taco universal con collarín y forma de nudo

MEDU



HUECOS



CÓDIGO	MEDIDA	VÁLIDO PARA	€/100	UD. MIN. VENTA		
MEDUB06	6 x 35 Ø6	TPPO 3,5-4	3,500	600	150	2.400
MEDUB07	8 x 45 Ø8	TPPO 4	7,843	400	100	1.600
MEDUB08	8 x 50 Ø8	TPPO 4-4,5	6,013	320	80	1.200
MEDUB10	10 x 60 Ø10	TPPO 6, TB 6-7	9,003	200	50	800



Blíster

CÓDIGO	MEDIDA	€/BOLSA	PCS B1	BOLSAS
BZMEDUB06	6 x 35 Ø6	2,561	10	20
BZMEDUB08	8 x 50 Ø8	2,561	10	20
BZMEDUB10	10 x 60 Ø10	2,561	6	20

Taco para placas de yeso laminado

TAPLA



HUECOS



CÓDIGO	MEDIDA	VÁLIDO PARA	€/100		MÍN. ESPESOR MATERIAL BASE	UD. MIN. VENTA		
TAPLANY	15 x 33	TPPO 4,5 x 40 / DIN-7981 4,2 x 38	12,200	PH3	9-16	200	100	1.600

TAPLA NY

Taco de nylon



Blíster

CÓDIGO	MEDIDA	€/BOLSA	PCS B1	BOLSAS
BZTAPLANY	15 x 33	2,561	4	15



HUECOS



CÓDIGO	MEDIDA	VÁLIDO PARA	€/100		MÍN. ESPESOR MATERIAL BASE	UD. MIN. VENTA		
TAPLAME	13 x 32	DIN-7981 4,2 x 32	31,087	PH2/PH3	9-16	200	100	1.600

TAPLA ME

Taco de Zamak con tornillo DIN 7981 4,2 x 32



Blíster

CÓDIGO	MEDIDA	€/BOLSA	PCS B1	BOLSAS
BZTAPLAME	13 x 32	3,350	4	15

TAPLA

Taco para placas de yeso laminado

TAPLA ZK

Taco de Zamak



CÓDIGO	MEDIDA	VÁLIDO PARA	€/100		MÍN. ESPESOR MATERIAL BASE	UD. MIN. VENTA		
TAPLAZK	13 x 37	TPPO 4,5 x 50 / DIN-7981 4,2 x 38	34,237	PZ3	9-16	200	100	1.600

ANCLA

Taco de nylon para ladrillos huecos y placas de yeso

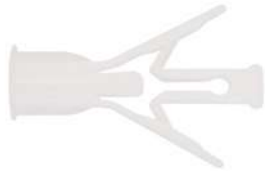

CÓDIGO	MEDIDA	€/100	UD. MIN. VENTA		
ANCLA40	10 x 40 Ø10	11,443	200	100	600
ANCLA47	10 x 47 Ø10	13,367	200	100	600



CÓDIGO	MEDIDA	€/BOLSA	PCS	BOLSAS
BZANCLA40	10 x 40 Ø10	2,561	4	12
BZANCLA47	10 x 47 Ø10	2,561	4	12



Anclaje Indemoll para fijación en elementos huecos

IN

HUECOS



CÓDIGO	€/100		
INPINZANI	1.553,553	1	20

INPIN

Pinza



HUECOS



CÓDIGO	€/100		
INPISANIN	3.474,087	1	10

INPIS

Pistola



HUECOS



CÓDIGO	COMPONENTES	MEDIDA COMPONENTES	UDS X KIT	€/KIT	KITS X
KITINPINO1	INPINZANI	-	1	49,577	1
	INCO432	M4 x 41 Ø 8	20		
	INCO537	M5 x 46 Ø 10	20		

KITINPIN

Kit de tabiquería seca



IN

Anclaje Indemoll para fijación en elementos huecos

IN-CO

Con tornillo cabeza redonda



CÓDIGO	MEDIDA	€/100	ESPESOR MÁX. A FIJAR		
INCO421	M4 x 30 Ø 8	26,100	17 -hmin	100	2.400
INCO432	M4 x 41 Ø 8	27,917	22 -hmin	100	1.200
INCO438	M4 x 47 Ø 8	30,327	30 -hmin	100	1.200
INCO446	M4 x 53 Ø 8	32,990	33 -hmin	100	1.200
INCO459	M4 x 67 Ø 8	37,233	52 -hmin	100	1.200
INCO537	M5 x 46 Ø 10	39,083	26 -hmin	100	1.200
INCO552	M5 x 59 Ø 10	43,140	42 -hmin	100	600
INCO565	M5 x 72 Ø 10	51,213	55 -hmin	100	600
INCO580	M5 x 89 Ø 10	57,430	61 -hmin	100	600
INCO637	M6 x 46 Ø 12	45,873	25 -hmin	100	1.200
INCO652	M6 x 59 Ø 12	53,283	38 -hmin	100	600
INCO665	M6 x 72 Ø 12	59,380	49 -hmin	100	600
INCO680	M6 x 89 Ø 12	74,263	78 -hmin	100	600



CÓDIGO	MEDIDA	€/BOLSA	PCS BOLSAS	BOLSAS
BZINCO432	M4 x 41 Ø 8	2,561	2	20
BZINCO438	M4 x 47 Ø 8	2,561	2	20
BZINCO537	M5 x 46 Ø 10	2,561	2	20
BZINCO552	M5 x 59 Ø 10	2,561	2	15
BZINCO565	M5 x 72 Ø 10	2,561	2	15
BZINCO637	M6 x 46 Ø 12	2,561	2	15
BZINCO652	M6 x 59 Ø 12	2,561	2	15

CÓDIGO	MEDIDA	€/CAJA	PCS CAJAS	CAJAS
VINCO432	M4 x 41 Ø 8	5,140	15	8
VINCO438	M4 x 47 Ø 8	5,557	15	8
VINCO446	M4 x 53 Ø 8	6,087	15	8
VINCO537	M5 x 46 Ø 10	7,070	15	8
VINCO552	M5 x 59 Ø 10	6,067	12	8
VINCO637	M6 x 46 Ø 12	5,343	10	8
VINCO652	M6 x 59 Ø 12	6,217	10	8

CÓDIGO	MEDIDA	€/BOLSA	PCS BOLSAS	BOLSAS
LSINCO432	M4 x 41 Ø 8	9,273	30	6
LSINCO438	M4 x 47 Ø 8	10,070	30	6
LSINCO446	M4 x 53 Ø 8	10,957	30	6
LSINCO537	M5 x 46 Ø 10	10,603	25	6
LSINCO552	M5 x 59 Ø 10	8,183	18	7
LSINCO637	M6 x 46 Ø 12	9,673	20	7
LSINCO652	M6 x 59 Ø 12	8,427	15	7

IN-HE

Con tornillo cabeza hexagonal



CÓDIGO	MEDIDA	€/100	ESPESOR MÁX. A FIJAR		
INHE837	M8 x 45 Ø 14	98,960	25 -hmin	100	600
INHE855	M8 x 60 Ø 14	113,837	36 -hmin	100	400
INHE865	M8 x 73 Ø 14	135,540	47 -hmin	100	400

IN-SI

Sin tornillo



CÓDIGO	MEDIDA	€/100	ESPESOR MÁX. A FIJAR		
INSI421	M4 x 21 Ø 8	20,027	17 -hmin	100	2.400
INSI432	M4 x 32 Ø 8	22,947	22 -hmin	100	2.400
INSI438	M4 x 38 Ø 8	23,700	30 -hmin	100	2.400
INSI537	M5 x 37 Ø 10	29,450	26 -hmin	100	1.200
INSI552	M5 x 52 Ø 10	34,530	42 -hmin	100	600
INSI565	M5 x 65 Ø 10	38,293	55 -hmin	100	600
INSI637	M6 x 37 Ø 12	35,693	25 -hmin	100	1.200
INSI652	M6 x 52 Ø 12	43,597	38 -hmin	100	600
INSI665	M6 x 65 Ø 12	48,840	49 -hmin	100	600
INSI865	M8 x 65 Ø 14	84,847	47 -hmin	100	400



Basculantes por gravedad para la fijación de elementos ligeros en falsos techos

BA-NO



CÓDIGO	MEDIDA	€/100	UD. MIN. VENTA		
BAESM04	M4 Ø14	65,523	100	50	300
BAESM05	M5 Ø14	69,820	100	50	300
BAESM06	M6 Ø16	90,813	100	50	200
BAESM08	M8 Ø20	149,363	50	50	200

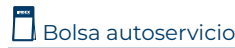
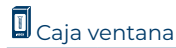

CÓDIGO	MEDIDA	€/BOLSA	PCS	BOLSAS
BZBAESM04	M4 Ø14	3,350	2	12
BZBAESM05	M5 Ø14	3,350	2	12
BZBAESM06	M6 Ø16	3,350	2	10

CÓDIGO	MEDIDA	€/CAJA	PCS	CAJAS
VBAESM04	M4 Ø14	5,837	6	8
VBAESM05	M5 Ø14	6,180	6	8
VBAESM06	M6 Ø16	5,217	4	8

CÓDIGO	MEDIDA	€/BOLSA	PCS	BOLSAS
LSBAESM04	M4 Ø14	5,612	6	6
LSBAESM05	M5 Ø14	5,779	6	6
LSBAESM06	M6 Ø16	5,014	4	6



Espiga



CÓDIGO	MEDIDA	€/100	UD. MIN. VENTA		
BAGAM04	M4 Ø14	68,146	100	50	300
BAGAM05	M5 Ø14	74,187	100	50	300
BAGAM06	M6 Ø16	92,710	100	50	200
BAGAM08	M8 Ø20	155,073	50	50	150



CÓDIGO	MEDIDA	€/BOLSA	PCS	BOLSAS
BZBAGAM04	M4 Ø14	3,350	2	12
BZBAGAM05	M5 Ø14	3,350	2	12
BZBAGAM06	M6 Ø16	3,350	2	10

CÓDIGO	MEDIDA	€/CAJA	PCS	CAJAS
VBAGAM04	M4 Ø14	6,047	6	8
VBAGAM05	M5 Ø14	6,330	6	8
VBAGAM06	M6 Ø16	5,453	4	8

CÓDIGO	MEDIDA	€/BOLSA	PCS	BOLSAS
LSBAGAM04	M4 Ø14	5,651	6	6
LSBAGAM05	M5 Ø14	6,086	6	6
LSBAGAM06	M6 Ø16	5,096	4	6



Gancho

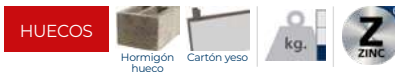

CÓDIGO	MEDIDA	€/100		
CABA004	M4 Ø14	33,781	100	1.200
CABA005	M5 Ø14	35,850	100	1.200
CABA006	M6 Ø16	41,803	100	600
CABA008	M8 Ø20	72,680	100	400



CÓDIGO	MEDIDA	€/CAJA	PCS	CAJAS
VCABA004	M4 Ø14	8,847	20	8
VCABA005	M5 Ø14	9,877	20	8
VCABA006	M6 Ø16	8,513	15	8

CÓDIGO	MEDIDA	€/BOLSA	PCS	BOLSAS
LSCABA004	M4 Ø14	8,885	20	6
LSCABA005	M5 Ø14	9,581	20	6
LSCABA006	M6 Ø16	8,386	15	7



Cabeza de basculante

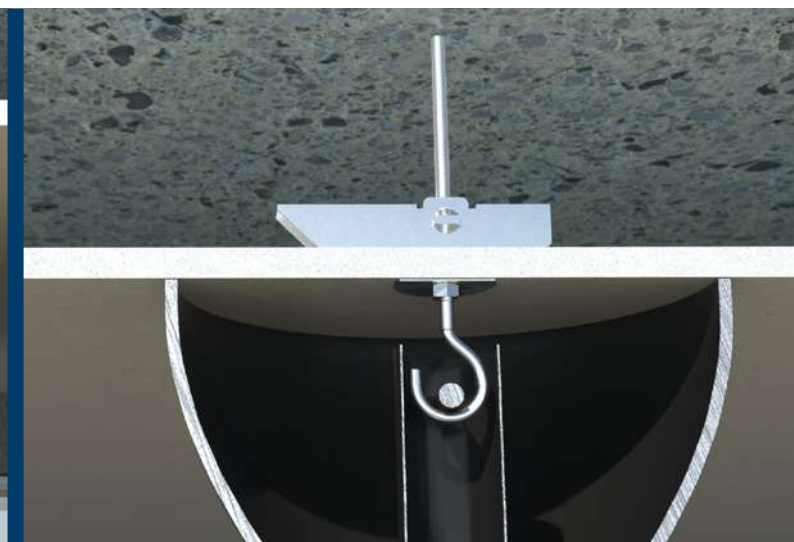
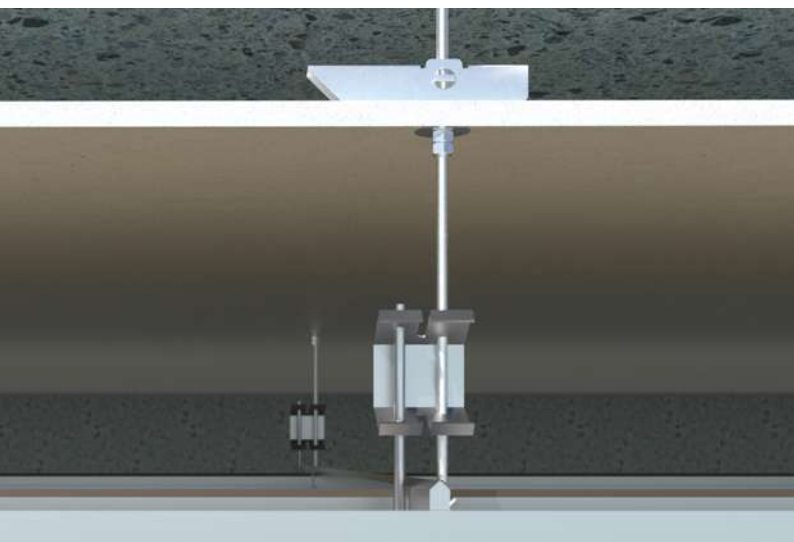

PA-LO

Palomilla con muelle

PA-ES

Espiga



02 Info. Técnica
P. 282

HUECOS

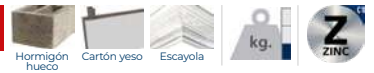

CÓDIGO	MEDIDA	€/100	UD. MIN. VENTA		
PAESM04	M4 Ø12	51,527	100	50	300
PAESM05	M5 Ø15	57,083	100	50	300
PAESM06	M6 Ø18	71,187	100	50	200
PAESM08	M8 Ø22	126,710	50	50	150

Blíster

CÓDIGO	MEDIDA	€/BOLSA	PCS	BOLSAS
BZPAESM04	M4 Ø12	3,350	2	12
BZPAESM05	M5 Ø15	3,350	2	12
BZPAESM06	M6 Ø18	3,350	2	10

Caja ventana

CÓDIGO	MEDIDA	€/CAJA	PCS	CAJAS
VPAESM04	M4 Ø12	4,780	6	8
VPAESM05	M5 Ø15	5,407	6	8
VPAESM06	M6 Ø18	4,577	4	8

Bolsa autoservicio

CÓDIGO	MEDIDA	€/BOLSA	PCS	BOLSAS
LSPAESM04	M4 Ø12	4,430	6	6
LSPAESM05	M5 Ø15	5,054	6	6
LSPAESM06	M6 Ø18	4,240	4	6

PA-GA

Gancho



02 Info. Técnica
P. 282

HUECOS

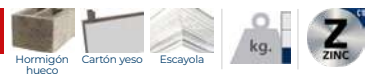

CÓDIGO	MEDIDA	€/100	UD. MIN. VENTA		
PAGAM04	M4 Ø12	52,537	100	50	300
PAGAM05	M5 Ø15	59,993	100	50	300
PAGAM06	M6 Ø18	84,307	100	50	200
PAGAM08	M8 Ø22	141,547	50	50	150

Blíster

CÓDIGO	MEDIDA	€/BOLSA	PCS	BOLSAS
BZPAGAM04	M4 Ø12	3,350	2	12
BZPAGAM05	M5 Ø15	3,350	2	12
BZPAGAM06	M6 Ø18	3,350	2	10

Caja ventana

CÓDIGO	MEDIDA	€/CAJA	PCS	CAJAS
VPAGAM04	M4 Ø12	4,607	6	8
VPAGAM05	M5 Ø15	5,360	6	8
VPAGAM06	M6 Ø18	4,823	4	8

Bolsa autoservicio

CÓDIGO	MEDIDA	€/BOLSA	PCS	BOLSAS
LSPAGAM04	M4 Ø12	4,648	6	6
LSPAGAM05	M5 Ø15	5,285	6	6
LSPAGAM06	M6 Ø18	4,972	4	6

CA-PA

Cabeza de palomilla



HUECOS

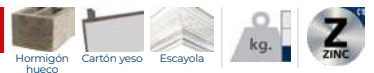

CÓDIGO	MEDIDA	€/100		
CAPA004	M4 Ø12	20,140	100	2.400
CAPA005	M5 Ø15	23,333	100	1.200
CAPA006	M6 Ø18	27,473	100	600
CAPA008	M8 Ø22	61,733	100	400

Caja ventana

CÓDIGO	MEDIDA	€/CAJA	PCS	CAJAS
VCAPA004	M4 Ø12	7,117	24	8
VCAPA005	M5 Ø15	7,017	20	8
VCAPA006	M6 Ø18	6,440	15	8

Bolsa autoservicio

CÓDIGO	MEDIDA	€/BOLSA	PCS	BOLSAS
LSCAPA004	M4 Ø12	6,720	24	8
LSCAPA005	M5 Ø15	6,622	20	7
LSCAPA006	M6 Ø18	5,844	15	7



Trampillas de registro para placa de yeso laminado

TR



CÓDIGO	MEDIDA	€/PC	
TRBL200200	200 x 200	27,903	1
TRBL300300	300 x 300	38,589	1
TRBL400400	400 x 400	54,333	1
TRBL500500	500 x 500	76,608	1
TRBL600600	600 x 600	97,959	1

TR-BL

Lacada blanca (RAL 9016)



CÓDIGO	MEDIDA	€/PC	
TR13200200	200 x 200	41,337	2
TR13300300	300 x 300	50,430	2
TR13400400	400 x 400	62,754	2
TR13500500	500 x 500	78,702	1
TR13600600	600 x 600	98,133	1

TR-13

13 mm



CÓDIGO	MEDIDA	€/PC	
TR15200200	200 x 200	90,003	2
TR15300300	300 x 300	100,290	2
TR15400400	400 x 400	116,169	2
TR15500500	500 x 500	140,262	1
TR15600600	600 x 600	163,638	1

TR-15

15 mm





FIJACIONES QUÍMICAS



QUÍMICOS



CÓDIGO	MEDIDA	€/PC	
MOPU300	300 ml.	15,203	12
MOPU410	410 ml.	18,383	12



M8-M24

MO-PU

Polyester universal. Homologado ETE Opt.7



QUÍMICOS



CÓDIGO	MEDIDA	€/PC	
MOP300	300 ml.	15,987	12
MOP410	410 ml.	18,887	12



M8-M24

MO-P+

Polyester PLUS. Homologado ETE Opt.7



QUÍMICOS



CÓDIGO	MEDIDA	€/PC	
MOPS300	300 ml.	18,313	12
MOPS410	410 ml.	22,857	12

KIT MO-PS+

MOPS300EP	300 ml.	30,393	1
-----------	---------	--------	---

- Contenido del KIT:
- Cartucho MOPS300 (300 ml) - x1
 - Cánulas MORCANU x2
 - Espárragos MOES08110 (M8 x 110 Ø8) - x4
 - Tamicas Nylon MOTN15085 (15 x 85) - x4

Ver video



COM TESTIGO DE MANIPULADO

¿Sabes hasta cuándo se puede manipular un anclaje químico ya aplicado?

El novedoso TESTIGO DE MANIPULADO incorporado en el MO-PS+ se trata de una tecnología única en el mercado. La resina cambia de color cuando inicia el proceso de curado, de azul a gris. Mientras se mantiene el tono azulado, el espárrago o varilla aplicada se puede manipular.

Working Time Indicator
Termin de Prise
Señal de Manuseo



M8-M24

MO-PS+

Polyester PLUS sin estireno con testigo de manipulado. Homologado ETE Opt.7



QUÍMICOS

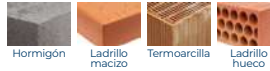

CÓDIGO	MEDIDA	€/PC	
MOPSP300	300 ml.	19,980	12
MOPSP410	410 ml.	24,933	12



M8-M24

MO-PSP+

Polyester PLUS sin estireno color piedra. Homologado ETE Opt.7



MO

Fijaciones químicas

MO-V

Vinylester.
Homologado
ETE Opt.7.



CÓDIGO	MEDIDA	€/PC	
MOV300	300 ml.	19,427	12
MOV410	410 ml.	23,547	12

QUÍMICOS Hormigón



MO-VS

Vinylester
sin estireno.
Homologado
ETE Opt.7



CÓDIGO	MEDIDA	€/PC	
MOV5300	300 ml.	22,930	12
MOV5410	410 ml.	27,857	12

QUÍMICOS Hormigón



MO-H

Híbrida sin estireno.
Homologado
ETE Opt.1



CÓDIGO	MEDIDA	€/PC	
MOH300	300 ml.	27,520	12
MOH410	410 ml.	32,013	12

QUÍMICOS Hormigón Hormigón fisurado Ladrillo macizo Hormigón armado Ladrillo hueco Termoarcilla



MO-HW

Híbrida sin estireno
versión WINTER.
Homologado
ETE Opt.1



CÓDIGO	MEDIDA	€/PC	
MOHW300	300 ml.	28,893	12
MOHW410	410 ml.	33,910	12

QUÍMICOS Hormigón Hormigón fisurado Ladrillo macizo Hormigón armado Ladrillo hueco Termoarcilla



Fijaciones químicas

MO

QUÍMICOS



CÓDIGO	MEDIDA	€/PC	
MOPURE600	600 ml.	79,380	12





MOPURE

Epoxy Puro 1:1.
Homologado ETE Opt.1

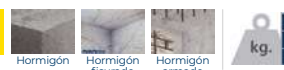

QUÍMICOS



CÓDIGO	MEDIDA	€/PC	
MOPUR30385	385 ml.	55,803	12
MOPUR30585	585 ml.	74,730	12



MOPUR3

Epoxy puro 3:1.
Homologado ETE Opt.1



INDEXmor CLOUD

SOFTWARE ONLINE PARA CALCULO DE MORTEROS QUÍMICOS

El software permite realizar el cálculo online de cuántos cartuchos serán necesarios utilizar en función de los parámetros introducidos, tanto en ladrillo como en hormigón (varilla métrica y barra corrugada).

Parámetros en Hormigón:

- Selección de elemento a instalar (Varilla métrica o barra corrugada).
- Número de taladros a rellenar.
- Selección de métrica (M8 - M32).
- Profundidad del taladro.
- Aprovechamiento del cartucho (óptima, buena, pobre).

Parámetros en Ladrillo:

- Número de taladros a rellenar.
- Selección de métrica (M8 - M12).
- Posibilidad de incluir tamiz roscado en el cálculo.

Prestaciones:

- Software 100% online.
- Facilidad de uso. Responsive design.
- Multilingüe: disponible en castellano, inglés, francés, alemán y portugués.



MO-PIS

Pistolas aplicadoras

MO-PIS

Pistolas aplicadoras



MOPISTO



MOPISPR



MOPISSI



MOPISPUR6



MOPISNEU



MOPISP3

CÓDIGO	MEDIDA	€/PC	
MOPISTO	Manual / Manuel 410 ml.	52,580	1
MOPISPR	Profesional / Professional / Professionnel 410 ml.	120,237	1
MOPISSI	Silicona / Silicone/ 300 ml.	32,727	1
MOPISPUR6	MOPURE600 - 600 ml.	75,677	1
MOPISNEU	Neumática / Pneumatic / Pneumatique	1.592,203	1
MOPISP3385	MOPUR3 - 385 ml.	135,400	1
MOPISP3585	MOPUR3 - 585 ml.	153,763	1

MO-TN

Tamiz de plástico



CÓDIGO	MEDIDA	€/100	UD. MIN. VENTA		
MOTN12050	12 x 50	39,110	24	12	2.256
MOTN12080	12 x 80	34,733	24	12	2.256
MOTN15085	15 x 85	34,393	24	12	1.500
MOTN15130	15 x 130	40,567	24	12	1.008
MOTN20085	20 x 85	39,137	24	12	1.008

Bolsa autoservicio

CÓDIGO	MEDIDA	€/BOLSA	PCS	BOLSAS
LSMOTN12050	12 x 50	2,773	4	7
LSMOTN15085	15 x 85	2,763	4	6
LSMOTN20085	20 x 85	2,440	2	6

MO-TR

Tamiz roscado



CÓDIGO	MEDIDA	€/100		
MOTRO08	M8 x 80 Ø12	200,487	12	540
MOTRO10	M10 x 80 Ø14	268,577	12	288
MOTRO12	M12 x 80 Ø16	325,187	12	288

MO-AC

Cánulas mezcladoras y varios



MOBOMBA
Bomba sopladora



MORCAPU
Cánula mezcladora (385-585-600 ml)



MORCEPKIT
Kit de 3 cepillos



MO-TL
Tamiz largo recortable para fijación en cubierta teja + rasillón



MORCANU
Cánula mezcladora (300-410 ml)



MO-PC
Extensor de cánula para fijaciones químicas

CÓDIGO	MEDIDA	€/PC		
MOBOMBA	Bomba Sopladora / Blow pump / Pompe soufflante	18,037	1	1
MORCANU	170 ml. - 300 ml. - 410 ml.	0,950	12	1.008
MORCAPU	Cánula/ Nozzle/ Canule/ Cánula (385-585-600 ml)	1,457	12	24
MORCEPKIT	Kit Cepillo / Brush / Écouvillon (1 x Ø14 - 1 x Ø20 - 1 x Ø27)	74,443	1	1
MOTL16330 NEW	16 x 330	312,304	-	10
MOPC185 NEW	185 mm	4,220	-	1

MO-ES

Espárrago roscado



CÓDIGO	MEDIDA	€/100		
MOES06070	M6 x 70 Ø6	64,373	12	540
MOES08110	M8 x 110 Ø8	108,943	12	288
MOES10115	M10 x 115 Ø10	144,697	12	144
MOES12110	M12 x 110 Ø12	192,790	12	144

Bolsa autoservicio

CÓDIGO	MEDIDA	€/BOLSA	PCS	BOLSAS
LSMOES06070	M6 x 70 Ø6	4,417	4	10
LSMOES08110	M8 x 110 Ø8	6,300	4	7
LSMOES10115	M10 x 115 Ø10	7,773	4	6
LSMOES12110	M12 x 110 Ø12	9,763	4	6

MO-TM

Tamiz metálico





CÓDIGO	MEDIDA	€/100	
MOTM12100	12 x 1000 Ø11	1.996,950	10
MOTM16100	16 x 1000 Ø14	2.261,427	10
MOTM22100	22 x 1000 Ø21	2.656,227	5

Resina de epoxi-acrilato, cuarzo y catalizador. Homologado ETE Opt. 8

CA-QU



CÓDIGO	MEDIDA	€/100		
CAQU008	8 x 80 Ø10	207,147	10	500
CAQU010	10 x 90 Ø12	211,907	10	500
CAQU012	12 x 110 Ø14	220,943	10	200
CAQU016	16 x 125 Ø18	245,643	10	200
CAQU020	20 x 170 Ø25	499,807	6	60
CAQU024	24 x 210 Ø28	585,190	6	60
CAQU030	30 x 280 Ø35	1.043,510	6	30

• Medidas sin homologar

CA-QU



Resina de epoxi-acrilato, cuarzo y catalizador. Homologado ETE Opción 8



Espárragos con tuerca y arandela para anclaje químico

EQ





CÓDIGO	MEDIDA	€/100		
EQAC08110	M8 x 110	100,143	10	240
EQAC10130	M10 x 130	157,953	10	120
EQAC10190	M10 x 190	235,000	10	30
EQAC12160	M12 x 160	234,777	10	120
EQAC12220	M12 x 220	362,450	10	30
EQAC16190	M16 x 190	453,417	10	40
EQAC16250	M16 x 250	653,957	10	30
EQAC20260	M20 x 260	998,733	6	12
EQAC20350	M20 x 350	1.438,063	6	-
EQAC24300	M24 x 300	1.517,933	6	12
EQAC24380	M24 x 380	2.378,070	6	-
EQAC30330	M30 x 330	2.866,893	6	12

EQ-AC

Cincado



CÓDIGO	MEDIDA	€/100		
EQ8808110	M8 x 110	105,153	10	240
EQ8810130	M10 x 130	165,853	10	120
EQ8812160	M12 x 160	244,463	10	60
EQ8816190	M16 x 190	481,620	6	24
EQ8820260	M20 x 260	1.057,667	6	24
EQ8824300	M24 x 300	1.608,033	6	12

EQ-8.8

Cincado 8.8



CÓDIGO	MEDIDA	€/100		
EQA208110	M8 x 110	280,257	10	240
EQA210130	M10 x 130	487,530	10	120
EQA212160	M12 x 160	807,990	10	120
EQA216190	M16 x 190	1.674,133	10	40
EQA220260	M20 x 260	3.199,710	6	12
EQA224300	M24 x 300	5.113,313	6	12
EQA230330	M30 x 330	8.582,733	6	12

EQ-A2

Inoxidable A2



CÓDIGO	MEDIDA	€/100		
EQA408110	M8 x 110	338,743	10	240
EQA410130	M10 x 130	615,293	10	120
EQA412160	M12 x 160	1.058,413	10	120
EQA416190	M16 x 190	2.073,420	10	40
EQA420260	M20 x 260	5.048,270	6	12
EQA424300	M24 x 300	8.320,540	6	12
EQA430330	M30 x 330	14.677,490	6	12

EQ-A4

Inoxidable A4



Tabla de selección



	MSPRB290	MSPRG290	MSPRM290	MSPRN290	MSTR290	MSSF290
	•	•	•	•		
	•	•	•	•		•
	•	•	•	•	•	•
	•	•	•	•	•	•
	•	•	•	•		
	•	•	•	•	•	•
	•	•	•	•	•	•
	•	•	•	•	•	•
	•	•	•	•	•	•
	•	•	•	•	•	•
	•	•	•	•	•	•
	•	•	•	•	•	•
	300 %	300 %	300 %	300 %	250 %	200 %
	150 kg/10 cm ²	150 kg/10 cm ²	150 kg/10 cm ²	150 kg/10 cm ²	140 kg/10 cm ²	430 kg/10 cm ²
	•	•	•	•	•	•
	•	•	•	•	•	•
	•	•	•	•	•	•
					•	
						•

Adhesivos Hybrid MS Polymer

MS

QUÍMICOS



CÓDIGO	MEDIDA	COLOR	€/PC	
MSPRB290	290 ml. (Blanco)	BLANCO	11,033	12
MSPRG290	290 ml. (Gris)	GRIS	11,033	12
MSPRM290	290 ml. (Marrón)	MARRÓN	11,033	12
MSPRN290	290 ml. (Negro)	NEGRO	11,033	12

APLICACIONES

- Pegado y sellado en construcción: repisas, remates en tejado, canalones, cubiertas, juntas de marcos o estructuras sometidas a vibraciones. Sellado y pegado en industria y automóvil.
- Relleno de grietas.
- Sellado de juntas de dilatación, cisternas, contenedores y otros elementos de aluminio.
- Producto certificado para el uso en la industria de procesamiento de alimentos (Certificado ISEGA).
- Adhesión a todo tipo de materiales: hormigón, madera, metal, corcho, aluminio, PVC, cobre, ladrillo, piedra, porcelana... No recomendado para Polietileno (PE), Polipropileno (PP) y Politetrafluoroetileno (PTFE).
- En caso de no conocer el material base se deberán realizar unas pruebas previas para garantizar el buen funcionamiento del producto.

MS-PR

Adhesivo MS Profesional



ISEGA

QUÍMICOS



CÓDIGO	MEDIDA	COLOR	€/PC	
MSTR290	290 ml. (Transparente)	TRANSPARENTE	16,555	12

APLICACIONES

- Incoloro. Adecuado para el pegado de vidrio, cristal, acrílico, PVC, porcelana, cerámica y otros elementos transparentes en interior o exterior.
- Fijación de materiales con una unión transparente o visible.
- Apto para aplicación sobre superficies húmedas.
- Adhesión a todo tipo de materiales (hormigón, madera, metal, corcho, aluminio, PVC, cobre, ladrillo, piedra, porcelana...). No recomendado para Polietileno (PE), Polipropileno (PP) y Politetrafluoroetileno (PTFE).
- En caso de no conocer el material base se deberán realizar unas pruebas previas para garantizar el buen funcionamiento del producto.
- Apto para montar y pegar.

MS-TR

Adhesivo MS Transparente



QUÍMICOS

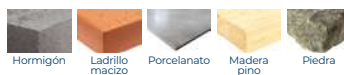

CÓDIGO	MEDIDA	COLOR	€/PC	
MSSF290	290 ml. (Blanco)	BLANCO	12,539	12

APLICACIONES

- Especialmente indicado para el pegado y conexión rápida de elementos pesados sin fijaciones adicionales. Triplica las prestaciones de agarre de otros adhesivos.
- Apto para usar en interior y exterior. Resistente a rayos UV.
- Adhesión a todo tipo de materiales: hormigón, madera, metal, corcho, aluminio, PVC, cobre, ladrillo, piedra, porcelana... No recomendado para Polietileno (PE), Polipropileno (PP) y Politetrafluoroetileno (PTFE).
- En caso de no conocer el material base se deberán realizar unas pruebas previas para garantizar el buen funcionamiento del producto.

MS-SF

Adhesivo MS Superfast High Tack



Tabla de selección

	SI-PR					SI-PRS		SI-UNI					SI-UNS		SE-ACR	
	SIPRB280	SIPRG280	SIPRM280	SIPRN280	SIPRT280	SIPRSB280	SIPRST280	SIUNIB280	SIUNIG280	SIUNIM280	SIUNIN280	SIUNIT280	SIUNSB280	SIUNST280	SEACRB280	SEACRG280
	•	•	•	•	•	•	•	•	•	•	•	•	•	•	•	•
	•	•	•	•	•	•	•	•	•	•	•	•	•	•	•	•
							•	•	•	•	•	•	•			
	•	•	•	•	•	•	•	•	•	•	•	•	•	•	•	•
	•	•	•	•	•	•	•	•	•	•	•	•	•	•	•	•
	•	•	•	•	•	•	•	•	•	•	•	•	•	•	•	•
	•	•	•	•	•	•	•	•	•	•	•	•	•	•	•	•
	•	•	•	•	•	•	•	•	•	•	•	•	•	•	•	•
															•	•
	•	•	•	•	•	•	•	•	•	•	•	•	•	•	•	•
	•	•	•	•	•	•	•	•	•	•	•	•	•	•	•	•
	•	•	•	•	•	•	•	•	•	•	•	•	•	•	•	•
	•	•	•	•	•	•	•	•	•	•	•	•	•	•	•	•
					•							•				•
						•	•					•	•			
						•	•					•	•			
	•	•	•	•	•											
	•	•	•	•	•	•	•									
															•	•
															•	•



Siliconas

SI

QUÍMICOS



CÓDIGO	MEDIDA	COLOR	€/PC	
SIPRB280	280 ml. (Blanco)	BLANCO	9,833	12
SIPRG280	280 ml. (Gris)	GRIS	9,833	12
SIPRM280	280 ml. (Marrón)	MARRÓN	9,833	12
SIPRN280	280 ml. (Negro)	NEGRO	9,833	12
SIPRT280	280 ml. (Transparente)	TRANSPARENTE	9,833	12

CARACTERÍSTICAS

- Elásticas y flexibles
- Apto para aplicación en ventanas
- Disponible en colores blanco, negro, marrón (RAL 8016), gris (RAL 7030) y transparente
- Multimaterial: aptas para su uso en carpintería de aluminio y PVC, juntas de dilatación, hormigón, ladrillos, piedra, madera, metales y vidrio)
- Certificado A+ sobre emisiones en interiores

QUÍMICOS



CÓDIGO	MEDIDA	COLOR	€/PC	
SIPRSB280	280 ml. (Blanco)	BLANCO	9,833	12
SIPRST280	280 ml. (Transparente)	TRANSPARENTE	9,833	12

CARACTERÍSTICAS

- Contienen fungicidas para evitar la aparición de moho
- Aptas para la aplicación en baños y cocinas
- Elásticas y flexibles
- Aptas para la aplicación en ventanas
- Disponible en color blanco y transparente
- Multimaterial: aptas para su uso en carpintería de aluminio y PVC, juntas de dilatación, hormigón, ladrillos, piedra, madera, metales y vidrio)

QUÍMICOS



CÓDIGO	MEDIDA	COLOR	€/PC	
SIUNIB280	280 ml. (Blanco)	BLANCO	6,700	12
SIUNIG280	280 ml. (Gris)	GRIS	6,700	12
SIUNIM280	280 ml. (Marrón)	MARRÓN	6,700	12
SIUNIT280	280 ml. (Transparente)	TRANSPARENTE	6,700	12

CARACTERÍSTICAS

- Multiusos: apto para su uso en aluminio, cerámica, vidrio y porcelana
- No aptas para materiales porosos, oxidables o atacables por ácidos
- Elásticas y flexibles
- Apto para aplicación en interior y exterior

SI-PR

Silicona Neutra Profesional para materiales lisos y porosos



SI-PRS

Silicona Neutra SANITAR Profesional con propiedades fungicidas



SI-UNI

Silicona acética universal multiusos



SI

Siliconas

SI-UNS

Silicona acética SANITAR universal multiusos con propiedades fungicidas

QUÍMICOS



CÓDIGO	MEDIDA	COLOR	€/PC	
SIUNSB280	280 ml. (Blanco)	BLANCO	6,700	12
SIUNST280	280 ml. (Transparente)	TRANSPARENTE	6,700	12

CARACTERÍSTICAS

- Contienen fungicidas para evitar la aparición de moho
- Aptas para la aplicación en baños y cocinas
- Elásticas y flexibles
- Aptas para la aplicación en ventanas
- Disponible en color blanco y transparente
- Multiusos: Aptas para su uso en aluminio, cerámica, vidrio y porcelana.
- No aptas para materiales porosos, oxidables o atacables por ácidos



SE-ACR

Masilla acrílica para juntas y grietas

QUÍMICOS



CÓDIGO	MEDIDA	COLOR	€/PC	
SEACRB280	280 ml. (Blanco)	BLANCO	4,727	12
SEACRG280	280 ml. (Gris)	GRIS	4,727	12

CARACTERÍSTICAS

- Apta para el sellado de todo tipo de juntas, pequeños agujeros, grietas en fachada, pared, ranuras en cajas de persianas, marcos de puertas y ventanas
- Apta para aplicación en materiales porosos (Hormigón, madera, baldosas de cerámica, placas de yeso) y para la reparación de pequeñas grietas
- Flexible y alta adherencia
- Se puede pintar y barnizar
- Muy fácil de aplicar
- Apto para aplicación en interior y exterior



MS-CA

Cánulas para MS y Siliconas

QUÍMICOS



MSCAHT



MSCATP

CÓDIGO	MEDIDA	VÁLIDO PARA	€/BOLSA		
MSCAHT	Ancha	MS-SF	13,273	1	18
MSCATP	Tapón	MS-PR, MS-T, SI	12,667	1	18

Espumas de poliuretano

PU

QUÍMICOS



CÓDIGO	MEDIDA	€/PC	
PUSP750	750 ml.	15,233	12



PU-SP

Espuma de poliuretano multiusos para aplicación con pistola



QUÍMICOS



CÓDIGO	MEDIDA	€/PC	
PUSC750	750 ml.	14,500	12



CÁNULA ECOFLEX

Su novedoso sistema de bloqueo permite conservar y reutilizar el producto varios días, permitiendo no desperdiciar producto y ser más respetuoso con el medioambiente.

PU-SC

Espuma de poliuretano multiusos para aplicación con cánula ECOFLEX



QUÍMICOS



CÓDIGO	MEDIDA	€/PC	
PUTP750	750 ml.	16,067	12



PU-TP

Espuma de poliuretano para aplicación con pistola. Color gris



PU

Espumas de poliuretano

PU-TPR

Espuma de poliuretano para fijación de tejas para aplicación con pistola. Color teja



CÓDIGO	MEDIDA	€/PC	
PUTPR750	750 ml.	16,067	12



PU-TC

Espuma de poliuretano para fijación de tejas para aplicación con cánula ECOFLEX. Color gris



CÓDIGO	MEDIDA	€/PC	
PUTC750	750 ml.	15,600	12



PU-FP

Espuma de poliuretano resistente al fuego para aplicación con pistola



CÓDIGO	MEDIDA	€/PC	
PUFP750	750 ml.	25,000	12



Espumas de poliuretano

PU

QUÍMICOS



CÓDIGO	MEDIDA	€/PC	
PUFC750	750 ml.	24,167	12



CÁNULA ECOFLEX

Su novedoso sistema de bloqueo permite conservar y reutilizar el producto varios días, permitiendo no desperdiciar producto y ser más respetuoso con el medioambiente.

PU-FC

Espuma de poliuretano resistente al fuego para aplicación con cánula ECOFLEX



QUÍMICOS



CÓDIGO	MEDIDA	€/PC	
PUEP750	750 ml.	22,100	12



PU-EP

Adhesivo de poliuretano SATE para paneles aislantes y placas de yeso laminado para aplicación con pistola



QUÍMICOS



CÓDIGO	MEDIDA	€/PC	
PUCL500	500 ml.	14,379	12

PU-CL

Limpiador de accesorios para la aplicación de espuma de poliuretano



PU-PI

Pistolas aplicadoras para espuma de poliuretano

PU-PI

QUÍMICOS

Profesional

CÓDIGO	MEDIDA	€/PC		
PUPI01	750 ml.	91,333	1	12



PU-PI 2

QUÍMICOS

Básica

CÓDIGO	MEDIDA	€/PC		
PUPI02	750 ml.	34,833	1	12



PU-CA

Cánula aplicadora para espuma de poliuretano

QUÍMICOS

CÓDIGO	MEDIDA	€/PC		
PUCA01	750 ml.	4,924	1	216





FIJACIONES METÁLICAS

A
PERFECT
FIXING
INDEX

MTH

Anclaje macho para cargas altas en hormigón no fisurado

MTH

Homologado ETE Opt.7. Eje cincado.
Clip cincado



Disponible con arandela DIN 9021.
Consultar precio y plazo



Útil de colocación

02 Info Técnica
P. 283

MACIZOS



CÓDIGO	MEDIDA	€/100	ESPESOR MÁX. A FIJAR	LETRA EJE (LONGITUD)		
AH06060	M6 x 60 Ø6	45,773	2	B	200	1.200
AH06070	M6 x 70 Ø6	47,520	12	C	200	1.200
AH06080	M6 x 80 Ø6	49,257	22	D	200	1.200
AH06090	M6 x 90 Ø6	50,760	32	E	200	1.200
AH06100	M6 x 100 Ø6	52,877	42	E	200	800
AH06110	M6 x 110 Ø6	67,620	52	F	200	800
AH06120	M6 x 120 Ø6	70,993	62	G	100	600
AH06130	M6 x 130 Ø6	82,123	72	H	100	600
AH06140	M6 x 140 Ø6	82,710	82	I	100	400
AH06150	M6 x 150 Ø6	84,863	92	I	100	400
AH06160	M6 x 160 Ø6	91,430	102	J	100	400
AH06170	M6 x 170 Ø6	103,670	112	K	100	400
AH06180	M6 x 180 Ø6	113,900	122	L	100	200
AH08060	M8 x 60 Ø8	56,657	3	B	100	600
AH08075	M8 x 75 Ø8	60,483	5	C	100	600
AH08090	M8 x 90 Ø8	65,567	20	E	100	600
AH08100	M8 x 100 Ø8	69,960	30	E	100	400
AH08115	M8 x 115 Ø8	81,300	45	G	100	400
AH08120	M8 x 120 Ø8	88,970	50	G	100	400
AH08130	M8 x 130 Ø8	91,877	60	H	100	400
AH08155	M8 x 155 Ø8	139,367	85	J	100	200
AH10070	M10 x 70 Ø10	74,897	3	C	100	400
AH10080	M10 x 80 Ø10	85,647	13	D	100	400
AH10090	M10 x 90 Ø10	89,300	10	E	100	400
AH10100	M10 x 100 Ø10	102,967	20	E	100	400
AH10120	M10 x 120 Ø10	108,037	40	G	50	300
AH10140	M10 x 140 Ø10	133,770	60	H	50	200
AH10150	M10 x 150 Ø10	140,497	70	I	50	200
AH10160	M10 x 160 Ø10	158,467	80	J	50	200
AH10170	M10 x 170 Ø10	173,317	90	K	50	200
AH10210	M10 x 210 Ø10	213,783	130	N	50	150
AH10230	M10 x 230 Ø10	226,760	150	P	50	100
AH12090	M12 x 90 Ø12	122,807	13	E	50	200
AH12100	M12 x 100 Ø12	132,737	8	E	50	200
AH12110	M12 x 110 Ø12	137,327	18	F	50	200
AH12120	M12 x 120 Ø12	170,387	28	G	50	200
AH12130	M12 x 130 Ø12	175,947	38	H	50	200
AH12140	M12 x 140 Ø12	176,350	48	H	50	200
AH12160	M12 x 160 Ø12	209,237	68	J	50	100
AH12180	M12 x 180 Ø12	240,980	88	L	50	150
AH12200	M12 x 200 Ø12	281,413	108	M	50	100
AH12220	M12 x 220 Ø12	305,413	128	O	50	100
AH12250	M12 x 250 Ø12	366,173	158	Q	25	50
AH14120	M14 x 120 Ø14	285,657	12	G	25	100
AH14145	M14 x 145 Ø14	335,437	37	I	25	100
AH14170	M14 x 170 Ø14	358,363	62	K	25	100
AH14220	M14 x 220 Ø14	496,900	112	O	25	75
AH14250	M14 x 250 Ø14	555,033	142	Q	25	50
AH16125	M16 x 125 Ø16	298,823	3	G	25	100
AH16145	M16 x 145 Ø16	322,007	23	I	25	100
AH16170	M16 x 170 Ø16	398,207	48	K	25	50
AH16220	M16 x 220 Ø16	474,513	98	O	25	50
AH16250	M16 x 250 Ø16	615,330	128	Q	25	50
AH16280	M16 x 280 Ø16	669,840	158	S	25	50
AH20170	M20 x 170 Ø20	588,077	23	K	20	40
AH20220	M20 x 220 Ø20	732,237	73	O	20	40
AH20270	M20 x 270 Ø20	1.000,717	123	S	20	40

• Medida sin homologar para fuego

Bolsa autoservicio

CÓDIGO	MEDIDA	€/BOLSA	PCS	BOLSAS
LSAH06060	M6 x 60 Ø6	13,017	30	6
LSAH08060	M8 x 60 Ø8	10,686	20	6
LSAH08075	M8 x 75 Ø8	9,555	16	6
LSAH08090	M8 x 90 Ø8	9,042	14	6
LSAH10070	M10 x 70 Ø10	8,068	10	5
LSAH10090	M10 x 90 Ø10	7,253	8	6
LSAH10120	M10 x 120 Ø10	6,906	6	6
LSAH12090	M12 x 90 Ø12	8,475	6	5
LSAH12110	M12 x 110 Ø12	8,850	6	5
LSAH16125	M16 x 125 Ø16	6,336	2	6

Anclaje macho para cargas altas en hormigón no fisurado

MTH

 MTH-AT **NEW**

Homologado ETE Opt.7. Eje ATLANTIS C4-M. Clip ATLANTIS C4-M

CÓDIGO	MEDIDA	€/100	ESPESOR MÁX. A FIJAR	LETRA EJE (LONGITUD)		
• AHAT06060	M6 x 60 Ø6	77,815	2	B	200	1.200
• AHAT06080	M6 x 80 Ø6	83,736	22	D	200	1.200
• AHAT06100	M6 x 100 Ø6	92,534	42	E	200	800
AHAT08060	M8 x 60 Ø8	99,149	3	B	100	600
AHAT08075	M8 x 75 Ø8	108,870	5	C	100	600
AHAT08090	M8 x 90 Ø8	121,298	20	E	100	600
AHAT08115	M8 x 115 Ø8	150,405	45	G	100	400
AHAT08130	M8 x 130 Ø8	160,784	60	H	100	400
AHAT08155	M8 x 155 Ø8	236,923	85	J	100	200
AHAT10070	M10 x 70 Ø10	157,283	3	C	100	400
AHAT10080	M10 x 80 Ø10	188,423	13	D	100	400
AHAT10090	M10 x 90 Ø10	196,460	10	E	100	400
AHAT10100	M10 x 100 Ø10	216,230	20	E	100	400
AHAT10120	M10 x 120 Ø10	243,083	40	G	50	300
AHAT10140	M10 x 140 Ø10	280,917	60	H	50	200
AHAT10150	M10 x 150 Ø10	295,043	70	I	50	200
AHAT10160	M10 x 160 Ø10	316,933	80	J	50	200
AHAT10170	M10 x 170 Ø10	337,968	90	K	50	200
AHAT10210	M10 x 210 Ø10	406,188	130	N	50	150
AHAT12090	M12 x 90 Ø12	282,455	13	E	50	200
AHAT12100	M12 x 100 Ø12	305,294	8	E	50	200
AHAT12110	M12 x 110 Ø12	315,851	18	F	50	200
AHAT12130	M12 x 130 Ø12	387,083	38	H	50	200
AHAT12140	M12 x 140 Ø12	370,335	48	H	50	200
AHAT12160	M12 x 160 Ø12	439,397	68	J	50	100
AHAT12180	M12 x 180 Ø12	506,058	88	L	50	150
AHAT12200	M12 x 200 Ø12	590,968	108	M	50	100
AHAT12220	M12 x 220 Ø12	626,097	128	O	50	100
AHAT12250	M12 x 250 Ø12	695,729	158	Q	25	50
AHAT16125	M16 x 125 Ø16	627,529	3	G	25	100
AHAT16145	M16 x 145 Ø16	708,415	23	I	25	100
AHAT16170	M16 x 170 Ø16	856,144	48	K	25	50
AHAT16220	M16 x 220 Ø16	1.067,655	98	O	25	50
AHAT16250	M16 x 250 Ø16	1.199,894	128	Q	25	50
AHAT16280	M16 x 280 Ø16	1.306,188	158	S	25	50
AHAT20170	M20 x 170 Ø20	1.323,173	23	K	20	40
AHAT20220	M20 x 220 Ø20	1.684,144	73	O	20	40
AHAT20270	M20 x 270 Ø20	1.951,398	123	S	20	40



Útil de colocación

• Medida sin homologar para fuego

MTH

Anclaje macho para cargas altas en hormigón no fisurado

MTH-A4

Homologado ETE Opt.7. Eje Inoxidable A4. Clip Inoxidable A4



Disponibles con arandela DIN 9021. Consultar precio y plazo

Util de colocación

Info. Técnica P. 284

INOXIDABLE



CÓDIGO	MEDIDA	€/100	ESPESOR MÁX. A FIJAR	LETRA EJE (LONGITUD)		
• MIA406045	M6 x 45 Ø6	173,095	1	A	200	1.200
• MIA406060	M6 x 60 Ø6	188,579	2	B	200	1.200
• MIA406080	M6 x 80 Ø6	210,889	22	D	200	1.200
• MIA408050	M8 x 50 Ø8	219,092	4	A	100	800
MIA408075	M8 x 75 Ø8	232,662	5	C	100	600
MIA408090	M8 x 90 Ø8	259,624	20	E	100	600
MIA408115	M8 x 115 Ø8	341,065	45	G	100	400
MIA410070	M10 x 70 Ø10	381,043	3	C	100	400
MIA410090	M10 x 90 Ø10	431,894	10	E	100	400
MIA410120	M10 x 120 Ø10	525,007	40	G	50	300
MIA410150	M10 x 150 Ø10	768,840	70	I	50	200
• MIA412075	M12 x 75 Ø12	569,823	5	C	50	300
MIA412090	M12 x 90 Ø12	592,563	13	D	50	200
MIA412110	M12 x 110 Ø12	682,320	18	F	50	200
MIA412140	M12 x 140 Ø12	818,203	48	I	50	200
• MIA416090	M16 x 90 Ø16	1.479,897	4	D	25	150
MIA416145	M16 x 145 Ø16	1.827,627	23	I	25	100
MIA416170	M16 x 170 Ø16	2.110,490	48	K	25	75
• MIA420120	M20 x 120 Ø20	2.453,313	5	G	20	40
MIA420170	M20 x 170 Ø20	3.353,590	23	K	20	40
MIA420220	M20 x 220 Ø20	4.174,890	73	O	20	40

• Medidas sin homologar
• Medida sin homologar para fuego

Caja ventana

CÓDIGO	MEDIDA	€/CAJA	PCS	CAJAS
VMIA408075	M8 x 75 Ø8	31,286	10	8
VMIA410090	M10 x 90 Ø10	42,817	8	8
VMIA412110	M12 x 110 Ø12	48,987	6	8

Bolsa autoservicio

CÓDIGO	MEDIDA	€/BOLSA	PCS	BOLSAS
LSMIA408075	M8 x 75 Ø8	34,525	12	7
LSMIA410090	M10 x 90 Ø10	45,071	8	7
LSMIA412110	M12 x 110 Ø12	49,064	6	5

MTH-A2

Homologado ETE Opt.7. Eje Inoxidable A2. Clip Inoxidable A2



Util de colocación

Info. Técnica P. 284

INOXIDABLE



CÓDIGO	MEDIDA	€/100	ESPESOR MÁX. A FIJAR	LETRA EJE (LONGITUD)		
• MIO6045	M6 x 45 Ø6	158,190	1	A	200	1.200
• MIO6060	M6 x 60 Ø6	177,403	2	B	200	1.200
• MIO6080	M6 x 80 Ø6	185,553	22	D	200	1.200
• MIO6120	M6 x 120 Ø6	229,172	62	G	100	600
• MIO6140	M6 x 140 Ø6	290,054	82	I	100	600
• MIO6160	M6 x 160 Ø6	314,630	102	J	100	400
• MIO6170	M6 x 170 Ø6	331,287	112	K	100	400
• MIO6180	M6 x 180 Ø6	383,183	122	L	100	300
• MIO8050	M8 x 50 Ø8	188,427	4	A	100	800
MIO8075	M8 x 75 Ø8	206,393	5	C	100	600
MIO8090	M8 x 90 Ø8	234,873	20	E	100	600
MIO8115	M8 x 115 Ø8	303,823	45	G	100	400
MI10070	M10 x 70 Ø10	319,347	3	C	100	400
MI10090	M10 x 90 Ø10	357,470	10	E	100	400
MI10120	M10 x 120 Ø10	418,990	40	G	50	300
MI10150	M10 x 150 Ø10	597,280	70	I	50	200
• MI12075	M12 x 75 Ø12	484,227	5	C	50	300
MI12090	M12 x 90 Ø12	485,333	13	D	50	200
MI12110	M12 x 110 Ø12	534,833	18	F	50	200
MI12140	M12 x 140 Ø12	670,347	48	I	50	200
• MI16090	M16 x 90 Ø16	1.262,968	4	D	25	150
MI16145	M16 x 145 Ø16	1.513,809	23	I	25	100
MI16170	M16 x 170 Ø16	1.659,910	48	K	25	75
• MI20120	M20 x 120 Ø20	2.008,703	5	G	20	40
MI20170	M20 x 170 Ø20	2.573,157	23	K	20	40
MI20220	M20 x 220 Ø20	3.157,720	73	O	20	40

• Medidas sin homologar
• Medida sin homologar para fuego

Blíster

CÓDIGO	MEDIDA	€/BOLSA	PCS	BOLSAS
BZMI08075	M8 x 75 Ø8	4,649	2	12
BZMI10090	M10 x 90 Ø10	4,649	2	10

Caja ventana

CÓDIGO	MEDIDA	€/CAJA	PCS	CAJAS
VMIO8075	M8 x 75 Ø8	28,888	10	8
VMIO8090	M8 x 90 Ø8	30,887	10	8
VMIO10070	M10 x 70 Ø10	31,918	8	8
VMIO10090	M10 x 90 Ø10	35,727	8	8
VMIO10120	M10 x 120 Ø10	31,406	6	8
VMIO12110	M12 x 110 Ø12	38,965	6	8

Bolsa autoservicio

CÓDIGO	MEDIDA	€/BOLSA	PCS	BOLSAS
LSMIO8075	M8 x 75 Ø8	29,317	12	7
LSMIO8090	M8 x 90 Ø8	33,362	12	7
LSMIO10070	M10 x 70 Ø10	35,911	10	6
LSMIO10090	M10 x 90 Ø10	35,727	8	6
LSMIO10120	M10 x 120 Ø10	37,689	8	6
LSMIO12110	M12 x 110 Ø12	38,965	6	6

Anclaje macho para cargas altas

MTA

Info
Técnica
P. 265

MACIZOS

CÓDIGO	MEDIDA	€/100	ESPESOR MÁX. A FIJAR		
AM06045	M6 x 45 Ø6	35,030	1	200	1.200
AM06055	M6 x 55 Ø6	38,023	11	200	1.200
AM06060	M6 x 60 Ø6	37,673	2	200	1.200
AM06065	M6 x 65 Ø6	38,133	7	200	1.200
AM06070	M6 x 70 Ø6	39,120	12	200	1.200
AM06080	M6 x 80 Ø6	40,180	22	200	1.200
AM06085	M6 x 85 Ø6	41,893	27	200	1.200
AM06090	M6 x 90 Ø6	42,380	32	200	1.200
AM06100	M6 x 100 Ø6	44,160	42	200	800
AM06110	M6 x 110 Ø6	48,177	52	200	800
AM06120	M6 x 120 Ø6	49,725	62	100	600
AM06130	M6 x 130 Ø6	49,902	72	100	600
AM06140	M6 x 140 Ø6	64,613	82	100	600
AM06150	M6 x 150 Ø6	72,457	92	100	600
AM06160	M6 x 160 Ø6	75,860	102	100	400
AM06170	M6 x 170 Ø6	95,247	112	100	400
AM06180	M6 x 180 Ø6	100,897	122	100	300
AM08050	M8 x 50 Ø8	45,763	4	100	800
AM08060	M8 x 60 Ø8	45,537	3	100	800
AM08065	M8 x 65 Ø8	47,477	8	100	600
AM08075	M8 x 75 Ø8	48,387	5	100	600
AM08090	M8 x 90 Ø8	52,643	20	100	600
AM08115	M8 x 115 Ø8	65,197	45	100	400
AM08120	M8 x 120 Ø8	66,447	50	100	400
AM08130	M8 x 130 Ø8	76,453	60	100	400
AM08155	M8 x 155 Ø8	129,467	85	100	200
AM10065	M10 x 65 Ø10	72,054	1	100	400
AM10070	M10 x 70 Ø10	65,653	3	100	400
AM10080	M10 x 80 Ø10	68,547	13	100	400
AM10090	M10 x 90 Ø10	73,912	10	100	400
AM10100	M10 x 100 Ø10	80,780	20	100	400
AM10120	M10 x 120 Ø10	87,727	40	50	300
AM10140	M10 x 140 Ø10	99,567	60	50	200
AM10150	M10 x 150 Ø10	112,007	70	50	200
AM10160	M10 x 160 Ø10	134,180	80	50	200

CÓDIGO	MEDIDA	€/100	ESPESOR MÁX. A FIJAR		
AM10170	M10 x 170 Ø10	140,343	90	50	200
AM10210	M10 x 210 Ø10	194,457	130	50	150
AM10230	M10 x 230 Ø10	220,417	150	50	100
AM12075	M12 x 75 Ø12	105,636	5	50	300
AM12080	M12 x 80 Ø12	104,203	3	50	300
AM12090	M12 x 90 Ø12	109,920	13	50	200
AM12100	M12 x 100 Ø12	109,630	8	50	200
AM12110	M12 x 110 Ø12	112,884	18	50	200
AM12120	M12 x 120 Ø12	128,627	28	50	200
AM12140	M12 x 140 Ø12	143,667	48	50	200
AM12160	M12 x 160 Ø12	174,178	68	50	100
AM12180	M12 x 180 Ø12	199,060	88	50	150
AM12220	M12 x 220 Ø12	261,157	128	50	100
AM12250	M12 x 250 Ø12	310,603	158	25	50
AM14080	M14 x 80 Ø14	187,847	5	50	200
AM14100	M14 x 100 Ø14	215,627	5	50	100
AM14120	M14 x 120 Ø14	241,820	12	25	100
AM14145	M14 x 145 Ø14	288,970	37	25	100
AM14170	M14 x 170 Ø14	314,343	62	25	100
AM14220	M14 x 220 Ø14	419,120	112	25	75
AM14250	M14 x 250 Ø14	459,840	142	25	50
AM16090	M16 x 90 Ø16	233,623	4	25	150
AM16110	M16 x 110 Ø16	236,173	7	25	150
AM16125	M16 x 125 Ø16	239,121	3	25	100
AM16145	M16 x 145 Ø16	256,389	23	25	100
AM16170	M16 x 170 Ø16	323,787	48	25	50
AM16220	M16 x 220 Ø16	392,827	98	25	50
AM16250	M16 x 250 Ø16	504,250	128	25	50
AM16280	M16 x 280 Ø16	548,890	158	25	50
AM20120	M20 x 120 Ø20	406,900	5	20	40
AM20170	M20 x 170 Ø20	487,927	23	20	40
AM20220	M20 x 220 Ø20	619,897	73	20	40
AM20270	M20 x 270 Ø20	830,287	123	20	40
AM24180	M24 x 180 Ø24	1.384,730	10	10	20
AM24260	M24 x 260 Ø24	1.906,377	80	10	20



Disponibles con arandela DIN 9021.
Consultar precio y plazo



Util de colocación

Blíster

CÓDIGO	MEDIDA	€/BOLSA	PCS BOLSAS	
BZAM06060	M6 x 60 Ø6	3,350	2 20	
BZAM06080	M6 x 80 Ø6	3,350	2 20	
BZAM08050	M8 x 50 Ø8	3,350	2 15	
BZAM08075	M8 x 75 Ø8	3,350	2 15	
BZAM08090	M8 x 90 Ø8	3,350	2 15	
BZAM10070	M10 x 70 Ø10	3,350	2 12	
BZAM10090	M10 x 90 Ø10	3,350	2 12	
BZAM10120	M10 x 120 Ø10	3,350	2 12	
BZAM12090	M12 x 90 Ø12	3,350	2 10	
BZAM12110	M12 x 110 Ø12	3,350	2 10	
BZAM12140	M12 x 140 Ø12	3,350	2 10	

Caja ventana

CÓDIGO	MEDIDA	€/CAJA	PCS CAJAS	
VAM06060	M6 x 60 Ø6	8,756	20 8	
VAM08075	M8 x 75 Ø8	7,325	12 8	
VAM08090	M8 x 90 Ø8	7,787	12 8	
VAM10070	M10 x 70 Ø10	4,912	6 8	
VAM10090	M10 x 90 Ø10	5,444	6 8	
VAM10120	M10 x 120 Ø10	6,470	6 8	
VAM12090	M12 x 90 Ø12	7,939	6 8	
VAM12110	M12 x 110 Ø12	8,297	6 8	

TH/TF

Anclaje de fijación directa en hormigón

THE

Homologado ETE Opt.1. Cabeza hexagonal con recubrimiento ATLANTIS C3-H



02 Info. Técnica P. 285

MACIZOS



CÓDIGO	HOMOLOGACIÓN SÍSMICA	ØBROCA X LONGITUD	€/100		ESPESOR MÁX. A FIJAR		
THE05040	-	Ø5 x 40	46,067	8	5	100	2.400
THE05050	-	Ø5 x 50	53,427	8	5	100	1.600
THE05060	-	Ø5 x 60	57,060	8	15	100	1.600
THE05080	-	Ø5 x 80	74,843	8	35	50	800
THE05100	-	Ø5 x 100	87,010	8	55	50	800
THE06040	-	Ø6 x 40	58,463	10	5	100	1.600
THE06050	C1	Ø6 x 50	63,167	10	15	100	1.200
THE06060	C1	Ø6 x 60	70,337	10	5	100	1.200
THE06070	C1	Ø6 x 70	77,953	10	15	50	600
THE06080	C1	Ø6 x 80	87,653	10	25	50	800
THE06100	C1	Ø6 x 100	110,160	10	45	25	400
THE06120	C1	Ø6 x 120	125,583	10	65	25	400
THE08055	C1 & C2	Ø8 x 55	117,673	13	5	50	600
THE08060	C1 & C2	Ø8 x 60	120,010	13	10	50	600
THE08070	C1 & C2	Ø8 x 70	132,390	13	5	50	200
THE08080	C1 & C2	Ø8 x 80	148,280	13	15	25	400
THE08090	C1 & C2	Ø8 x 90	160,057	13	25	25	400
THE08100	C1 & C2	Ø8 x 100	168,943	13	35	25	400
THE08110	C1 & C2	Ø8 x 110	176,567	13	45	25	400
THE08120	C1 & C2	Ø8 x 120	242,560	13	55	25	400
THE08140	C1 & C2	Ø8 x 140	249,630	13	75	25	300
THE10060	-	Ø10 x 60	222,307	15	5	50	200
THE10070	-	Ø10 x 70	241,273	15	15	50	200
THE10080	-	Ø10 x 80	259,587	15	25	50	300
THE10090	C1 & C2	Ø10 x 90	268,667	15	5	25	300
THE10100	C1 & C2	Ø10 x 100	277,257	15	15	25	300
THE10120	C1 & C2	Ø10 x 120	318,643	15	35	25	200
THE10140	C1 & C2	Ø10 x 140	353,493	15	55	25	100
THE12080	C1 & C2	Ø12 x 80	334,837	18	5	25	100
THE12090	-	Ø12 x 90	357,740	18	15	25	100
THE12110	C1 & C2	Ø12 x 110	408,707	18	5	25	100
THE12130	C1 & C2	Ø12 x 130	469,943	18	25	25	150
THE12150	C1 & C2	Ø12 x 150	520,620	18	45	25	100
THE14080	-	Ø14 x 80	513,083	21	5	25	150
THE14100	-	Ø14 x 100	609,290	21	25	25	150
THE14120	C1 & C2	Ø14 x 120	710,027	21	5	25	100
THE14130	C1 & C2	Ø14 x 130	805,510	21	15	25	100
THE14140	C1 & C2	Ø14 x 140	867,473	21	25	25	100
THE14160	C1 & C2	Ø14 x 160	943,767	21	45	25	50
THE16100	NEW	Ø16 x 100	826,687	-	20	25	100
THE16150	NEW	Ø16 x 150	1.150,703	-	30	25	75
THE18100	C1 & C2	Ø18 x 100	1.022,780	24	10	20	80
THE18130	C1 & C2	Ø18 x 130	1.193,700	24	40	20	40
THE18160	C1 & C2	Ø18 x 160	1.391,507	24	20	15	30
THE18180	C1 & C2	Ø18 x 180	1.505,443	24	40	15	30
THE18200	C1 & C2	Ø18 x 200	1.651,080	24	60	10	20

THA

Homologado ETE Opt.1. Cabeza avellanada con recubrimiento ATLANTIS C3-H



02 Info. Técnica P. 285

MACIZOS

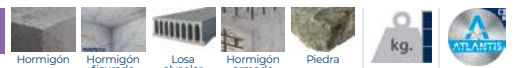

CÓDIGO	HOMOLOGACIÓN SÍSMICA	ØBROCA X LONGITUD	€/100		ESPESOR MÁX. A FIJAR		
THA05040	-	Ø5 x 40	54,380	TX25	5	100	2.400
THA05060	-	Ø5 x 60	64,053	TX25	15	100	1.200
THA05080	-	Ø5 x 80	81,180	TX25	35	50	800
THA05100	-	Ø5 x 100	91,513	TX25	55	50	800
THA06045	C1	Ø6 x 45	75,860	TX30	10	100	1.600
THA06050	C1	Ø6 x 50	79,100	TX30	15	100	1.200
THA06060	C1	Ø6 x 60	93,003	TX30	5	100	1.200
THA06080	C1	Ø6 x 80	112,020	TX30	25	100	600
THA06120	C1	Ø6 x 120	125,833	TX30	65	100	400
THA06140	C1	Ø6 x 140	161,323	TX30	85	100	600
THA08060	-	Ø8 x 60	153,210	TX45	10	50	200
THA08080	-	Ø8 x 80	186,177	TX45	15	25	400
THA08100	C1 & C2	Ø8 x 100	223,920	TX45	35	25	400
THA08120	C1 & C2	Ø8 x 120	251,283	TX45	55	25	400
THA10100	C1 & C2	Ø10 x 100	339,207	TX50	15	25	300
THA10120	C1 & C2	Ø10 x 120	393,763	TX50	35	25	200

Anclaje de fijación directa en hormigón

TH/TF

02 Info Técnica
P. 287

MACIZOS



CÓDIGO	HOMOLOGACIÓN SÍSMICA	ØBROCA X LONGITUD	€/100	ESPESOR MÁX. A FIJAR	kg.	kg.
THP05040	-	Ø5 x 40	53,580	TX30	5	100
THP05060	-	Ø5 x 60	61,640	TX30	15	100
THP06040	-	Ø6 x 40	64,423	TX40	5	100
THP06050	C1	Ø6 x 50	75,967	TX40	15	100
THP06060	C1	Ø6 x 60	86,600	TX40	5	100
THP06080	C1	Ø6 x 80	107,390	TX40	25	50
THP06100	C1	Ø6 x 100	127,520	TX40	45	50
THP08060	-	Ø8 x 60	152,170	TX45	10	25
THP08080	-	Ø8 x 80	176,803	TX45	15	25

THP

Homologado ETE Opt.1. Cabeza alomada con recubrimiento ATLANTIS C3-H



02 Info Técnica
P. 287

MACIZOS

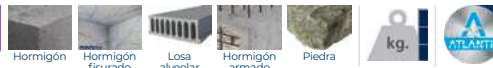

CÓDIGO	ØBROCA X LONGITUD	€/100	ESPESOR MÁX. A FIJAR	kg.	kg.
THT06040	Ø6 x 40	83,800	TX30	5	100
THT06050	Ø6 x 50	99,760	TX30	15	100
THT06060	Ø6 x 60	113,727	TX30	5	100

THT

Homologado ETE Opt.1. Cabeza Truss con recubrimiento ATLANTIS C3-H

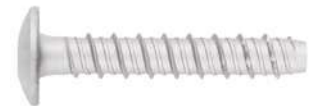

MACIZOS



CÓDIGO	MEDIDA	€/100	ESPESOR MÁX. A FIJAR	kg.	kg.
TXE06040	Ø6 x 40	224,863	10	5	100
TXE06060	Ø6 x 60	251,333	10	5	100
TXE08070	Ø8 x 70	362,343	13	5	50
TXE08080	Ø8 x 80	400,000	13	15	25
TXE08090	Ø8 x 90	450,000	13	25	25
TXE08105	Ø8 x 105	525,027	13	40	25
TXE10070	Ø10 x 70	441,697	15	15	50
TXE10090	Ø10 x 90	567,897	15	5	25
TXE10100	Ø10 x 100	609,187	15	15	25
TXE10120	Ø10 x 120	693,627	15	35	25
TXE12080	Ø12 x 80	659,273	18	5	25
TXE12110	Ø12 x 110	906,500	18	5	25

TXE **NEW**

Tornillo hormigón hexagonal con punta Bimetal. Inoxidable A4



TH/TF

Anclaje de fijación directa en hormigón

TFE

Homologado ETE Opt.1. Cabeza hexagonal con recubrimiento cincado



02 Info. Técnica P. 287

MACIZOS



CÓDIGO	HOMOLOGACIÓN SÍSMICA	ØBROCA X LONGITUD	€/100		ESPESOR MÁX. A FIJAR		
TFE05040	-	Ø5 x 40	39,253	8	5	100	2.400
TFE05050	-	Ø5 x 50	45,530	8	5	100	1.600
TFE05060	-	Ø5 x 60	48,630	8	15	100	1.600
TFE05080	-	Ø5 x 80	63,780	8	35	50	800
TFE05100	-	Ø5 x 100	74,147	8	55	50	800
TFE06040	-	Ø6 x 40	49,820	10	5	100	1.600
TFE06050	C1	Ø6 x 50	53,827	10	15	100	1.200
TFE06060	C1	Ø6 x 60	59,940	10	5	100	1.200
TFE06070	C1	Ø6 x 70	66,433	10	15	50	600
TFE06080	C1	Ø6 x 80	74,693	10	25	50	800
TFE06100	C1	Ø6 x 100	93,880	10	45	25	400
TFE06120	C1	Ø6 x 120	107,020	10	65	25	400
TFE08055	C1 & C2	Ø8 x 55	95,927	13	5	50	600
TFE08060	C1 & C2	Ø8 x 60	97,833	13	10	50	600
TFE08070	C1 & C2	Ø8 x 70	107,923	13	5	50	200
TFE08080	C1 & C2	Ø8 x 80	120,870	13	15	25	400
TFE08090	C1 & C2	Ø8 x 90	130,470	13	25	25	400
TFE08100	C1 & C2	Ø8 x 100	137,717	13	35	25	400
TFE08110	C1 & C2	Ø8 x 110	143,923	13	45	25	400
TFE08120	C1 & C2	Ø8 x 120	197,723	13	55	25	400
TFE08140	C1 & C2	Ø8 x 140	203,490	13	75	25	300
TFE10060	-	Ø10 x 60	172,977	15	5	50	200
TFE10070	-	Ø10 x 70	187,740	15	15	50	200
TFE10080	-	Ø10 x 80	201,987	15	25	50	300
TFE10090	C1 & C2	Ø10 x 90	209,060	15	5	25	300
TFE10100	C1 & C2	Ø10 x 100	215,733	15	15	25	300
TFE10120	C1 & C2	Ø10 x 120	247,943	15	35	25	200
TFE10140	C1 & C2	Ø10 x 140	275,057	15	55	25	100
TFE12080	-	Ø12 x 80	248,130	18	5	25	100
TFE12090	-	Ø12 x 90	265,107	18	15	25	100
TFE12110	C1 & C2	Ø12 x 110	302,870	18	5	25	100
TFE12130	C1 & C2	Ø12 x 130	348,253	18	25	25	150
TFE12150	C1 & C2	Ø12 x 150	385,810	18	45	25	100
TFE14080	-	Ø14 x 80	356,460	21	5	25	150
TFE14100	-	Ø14 x 100	423,297	21	25	25	150
TFE14120	C1 & C2	Ø14 x 120	493,280	21	5	25	100
TFE14130	C1 & C2	Ø14 x 130	559,620	21	15	25	100
TFE14140	C1 & C2	Ø14 x 140	602,670	21	25	25	100
TFE14160	C1 & C2	Ø14 x 160	655,667	21	45	25	50
TFE16100	NEW	Ø16 x 100	617,800	-	20	25	100
TFE16150	NEW	Ø16 x 150	853,137	-	30	25	75
TFE18100	C1 & C2	Ø18 x 100	710,563	24	10	20	80
TFE18130	C1 & C2	Ø18 x 130	829,307	24	40	20	40
TFE18160	C1 & C2	Ø18 x 160	966,733	24	20	15	30
TFE18180	C1 & C2	Ø18 x 180	1.045,890	24	40	15	30
TFE18200	C1 & C2	Ø18 x 200	1.147,067	24	60	10	20

TFN

Homologado ETE Opt.1. Cabeza hexagonal con recubrimiento cincado y sin arandela



02 Info. Técnica P. 288

MACIZOS

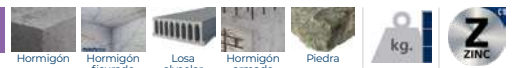

CÓDIGO	HOMOLOGACIÓN SÍSMICA	ØBROCA X LONGITUD	€/100		ESPESOR MÁX. A FIJAR		
TFN14080	C1	Ø14 x 80	513,083	24	5	25	150

Anclaje de fijación directa en hormigón

TH/TF

02 Info
Técnica
P. 288

MACIZOS



CÓDIGO	HOMOLOGACIÓN SÍSMICA	ØBROCA X LONGITUD	€/100	Nº HUELLA	ESPESOR MÁX. A FIJAR		
TFS06100	C1	Ø6 x 100 (M8)	145,240	5	35	50	800
TFS06120	C1	Ø6 x 120 (M8)	161,020	5	55	50	600
TFS08110	C1 & C2	Ø8 x 110 (M10)	215,297	7	32	50	400
TFS08130	C1 & C2	Ø8 x 130 (M10)	239,413	7	52	50	400
TFS10120	C1 & C2	Ø10 x 120 (M12)	313,570	8	27	25	200
TFS10140	C1 & C2	Ø10 x 140 (M12)	349,543	8	47	25	200

TFS

Homologado ETE Opt.1. Espárrago cincado



02 Info
Técnica
P. 288

MACIZOS



CÓDIGO	ØBROCA X LONGITUD	€/100	Nº HUELLA		
TFM06035	Ø6 x 35 (M8)	109,593	13	100	400
TFM06055	Ø6 x 55 (M10)	128,713	13	100	600

TFM

Homologado ETE Opt.1. Rosca macho métrica cincado



02 Info
Técnica
P. 288

MACIZOS

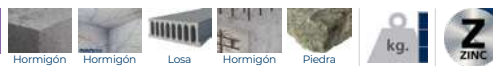

CÓDIGO	ØBROCA X LONGITUD	€/100			
TFF06035	Ø6 x 35 (M8-M10)	132,883	13	50	200
TFF06055	Ø6 x 55 (M8-M10)	143,477	13	50	200

TFF

Homologado ETE Opt.1. Rosca hembra métrica cincada



CH

Anclaje antigiro para cargas medias

CH-TO

Tornillo hexagonal 6.8. Homologado ETE Opt.7



MACIZOS



CÓDIGO	MEDIDA	€/100		
• ACHT08C	M6 x 45 Ø8	32,067	200	1.200
• ACHT09C	M6 x 45 Ø9	39,940	200	800
• ACHT08L	M6 x 60 Ø8	37,153	200	800
• ACHT09L	M6 x 60 Ø9	45,210	200	800
• ACHT10C	M8 x 60 Ø10	51,173	100	600
• ACHT11C	M8 x 60 Ø11	60,670	100	400
• ACHT10L	M8 x 80 Ø10	59,990	100	400
• ACHT11L	M8 x 80 Ø11	73,070	100	400
• ACHT12C	M10 x 70 Ø12	81,643	100	200
• ACHT14C	M10 x 70 Ø14	102,887	100	200
• ACHT12L	M10 x 100 Ø12	100,890	50	200
• ACHT14L	M10 x 100 Ø14	125,060	50	200
• ACHT16C	M12 x 80 Ø16	158,297	50	200
• ACHT16L	M12 x 110 Ø16	192,067	50	100
• ACHT20C	M16 x 110 Ø20	346,107	25	50
• ACHT25C	M20 x 130 Ø25	988,593	15	45

• Medidas sin homologar

Blíster

CÓDIGO	MEDIDA	€/BOLSA	PCS	BOLSAS
BZACHT08C	M6 x 45 Ø8	3,350	2	15
BZACHT08L	M6 x 60 Ø8	3,350	2	15
BZACHT10C	M8 x 60 Ø10	3,350	2	15
BZACHT10L	M8 x 80 Ø10	3,350	2	15
BZACHT12C	M10 x 70 Ø12	3,350	2	10
BZACHT12L	M10 x 100 Ø12	3,350	2	10

Caja ventana

CÓDIGO	MEDIDA	€/CAJA	PCS	CAJAS
VACHT08C	M6 x 45 Ø8	6,237	15	8
VACHT08L	M6 x 60 Ø8	7,020	15	8
VACHT10C	M8 x 60 Ø10	6,606	10	8
VACHT10L	M8 x 80 Ø10	7,744	10	8
VACHT12C	M10 x 70 Ø12	8,345	8	8
VACHT12L	M10 x 100 Ø12	7,935	6	8
VACHT16C	M12 x 80 Ø16	8,025	4	8

Bolsa autoservicio

CÓDIGO	MEDIDA	€/BOLSA	PCS	BOLSAS
LSACHT08C	M6 x 45 Ø8	9,794	24	6
LSACHT08L	M6 x 60 Ø8	7,712	16	6
LSACHT10C	M8 x 60 Ø10	5,755	8	6
LSACHT10L	M8 x 80 Ø10	6,331	8	6
LSACHT12C	M10 x 70 Ø12	8,345	8	6
LSACHT12L	M10 x 100 Ø12	9,690	8	6
LSACHT16C	M12 x 80 Ø16	8,067	4	5

CH-A2

Inoxidable A2. Homologado ETE Opt.7



INOXIDABLE

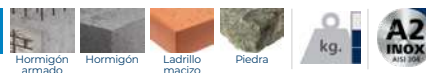

CÓDIGO	MEDIDA	€/100		
• ACHTA208C	M6 x 45 Ø8	114,150	100	1.200
• ACHTA209C	M6 x 45 Ø9	129,177	100	1.200
• ACHTA208L	M6 x 60 Ø8	128,957	100	600
• ACHTA209L	M6 x 60 Ø9	149,200	100	600
• ACHTA210C	M8 x 60 Ø10	184,947	100	600
• ACHTA211C	M8 x 60 Ø11	222,503	100	400
• ACHTA210L	M8 x 80 Ø10	212,753	100	400
• ACHTA211L	M8 x 80 Ø11	262,103	100	400
• ACHTA212C	M10 x 70 Ø12	311,993	100	200
• ACHTA214C	M10 x 70 Ø14	415,027	100	300
• ACHTA212L	M10 x 100 Ø12	381,557	50	200
• ACHTA214L	M10 x 100 Ø14	462,917	50	200
• ACHTA216C	M12 x 80 Ø16	615,203	50	100
• ACHTA216L	M12 x 110 Ø16	778,480	50	100
• ACHTA220C	M16 x 110 Ø20	1.598,263	25	75

• Medidas sin homologar

Blíster

CÓDIGO	MEDIDA	€/BOLSA	PCS	BOLSAS
BZACHTA208C	M6 x 45 Ø8	4,649	2	15
BZACHTA208L	M6 x 60 Ø8	4,649	2	15
BZACHTA210C	M8 x 60 Ø10	4,649	2	15
BZACHTA210L	M8 x 80 Ø10	4,649	2	15

Caja ventana

CÓDIGO	MEDIDA	€/CAJA	PCS	CAJAS
VACHTA208C	M6 x 45 Ø8	13,629	10	8
VACHTA208L	M6 x 60 Ø8	15,847	10	8
VACHTA210C	M8 x 60 Ø10	14,191	6	8
VACHTA210L	M8 x 80 Ø10	16,897	6	8
VACHTA212C	M10 x 70 Ø12	15,924	4	8
VACHTA212L	M10 x 100 Ø12	19,655	4	8

Bolsa autoservicio

CÓDIGO	MEDIDA	€/BOLSA	PCS	BOLSAS
LSACHTA208C	M6 x 45 Ø8	14,721	12	6
LSACHTA208L	M6 x 60 Ø8	17,114	12	6
LSACHTA210C	M8 x 60 Ø10	17,030	8	6
LSACHTA210L	M8 x 80 Ø10	20,276	8	6
LSACHTA212C	M10 x 70 Ø12	21,502	6	6
LSACHTA212L	M10 x 100 Ø12	19,655	4	5

Anclaje antigiro para cargas medias

CH



MACIZOS



CÓDIGO	MEDIDA	€/100	APERTURA GANCHO		
ACHG08C	M6 x 45 Ø8	55,500	10	100	600
ACHG09C	M6 x 45 Ø9	61,383	10	100	600
ACHG10C	M8 x 60 Ø10	92,297	13	100	400
ACHG11C	M8 x 60 Ø11	101,640	13	100	400
ACHG12C	M10 x 70 Ø12	149,337	14	50	200
ACHG14C	M10 x 70 Ø14	171,120	14	50	200
ACHG16C	M12 x 80 Ø16	271,170	22	25	100

CH-GA

Gancho



Blíster

CÓDIGO	MEDIDA	€/BOLSA	PCS	BOLSAS
BZACHG08C	M6 x 45 Ø8	3,350	2	15
BZACHG10C	M8 x 60 Ø10	3,350	2	15
BZACHG12C	M10 x 70 Ø12	3,350	2	10

Caja ventana

CÓDIGO	MEDIDA	€/CAJA	PCS	CAJAS
VACHG08C	M6 x 45 Ø8	6,754	10	8
VACHG10C	M8 x 60 Ø10	6,855	6	8

Bolsa autoservicio

CÓDIGO	MEDIDA	€/BOLSA	PCS	BOLSAS
LSACHG08C	M6 x 45 Ø8	7,915	12	6
LSACHG10C	M8 x 60 Ø10	6,855	6	6



MACIZOS



CÓDIGO	MEDIDA	€/100	Ø OJO		
ACHA08C	M6 x 45 Ø8	55,500	10	100	600
ACHA09C	M6 x 45 Ø9	61,383	10	100	600
ACHA10C	M8 x 60 Ø10	92,297	13	100	400
ACHA11C	M8 x 60 Ø11	101,640	13	100	200
ACHA12C	M10 x 70 Ø12	149,337	14	50	200
ACHA14C	M10 x 70 Ø14	171,120	14	50	200
ACHA16C	M12 x 80 Ø16	271,170	22	25	100

CH-AR

Argolla



Blíster

CÓDIGO	MEDIDA	€/BOLSA	PCS	BOLSAS
BZACHA08C	M6 x 45 Ø8	3,350	2	15
BZACHA10C	M8 x 60 Ø10	3,350	2	15
BZACHA12C	M10 x 70 Ø12	3,350	2	10

Caja ventana

CÓDIGO	MEDIDA	€/CAJA	PCS	CAJAS
VACHA08C	M6 x 45 Ø8	6,877	10	8
VACHA10C	M8 x 60 Ø10	6,855	6	8

Bolsa autoservicio

CÓDIGO	MEDIDA	€/BOLSA	PCS	BOLSAS
LSACHA08C	M6 x 45 Ø8	9,373	14	6
LSACHA10C	M8 x 60 Ø10	6,855	6	6



MACIZOS



CÓDIGO	MEDIDA	€/100			
ACHTPL08C	M6 x 45 Ø8	54,383	4	100	1.600
ACHTPL08L	M6 x 60 Ø8	79,757	4	100	1.200
ACHTPL10C	M8 x 60 Ø10	89,370	5	100	400
ACHTPL10L	M8 x 80 Ø10	120,477	5	100	600
ACHTPL12C	M10 x 70 Ø12	158,240	6	50	400
ACHTPL12L	M10 x 100 Ø12	271,307	6	50	300

CH-PL

Cabeza plana. Homologado ETE Opt.7



CH

Anclaje antigiro para cargas medias

CH-PI

Cabeza plana inoxidable A2.
Homologado ETE Opt.7



02 Info
P. 289 Técnica

INOXIDABLE

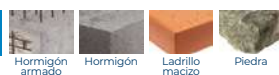

CÓDIGO	MEDIDA	€/100			
ACHTPI08C	M6 x 45 Ø8	118,747	4	100	1.200
ACHTPI08L	M6 x 60 Ø8	152,047	4	100	1.200
ACHTPI10C	M8 x 60 Ø10	224,017	5	100	600
ACHTPI10L	M8 x 80 Ø10	265,190	5	100	400
ACHTPI12C	M10 x 70 Ø12	354,223	6	50	300
ACHTPI12L	M10 x 100 Ø12	418,203	6	50	300

CH-INB

Cabeza inviolable cincada.
Homologado ETE Opt.7



02 Info
P. 289 Técnica

MACIZOS



CÓDIGO	MEDIDA	€/100			
ACHINB08C	M6 x 45 Ø8	56,020	TX40	100	1.200
ACHINB08L	M6 x 60 Ø8	64,207	TX40	100	800
ACHINB10C	M8 x 60 Ø10	79,450	TX40	100	600
ACHINB10L	M8 x 80 Ø10	93,707	TX40	100	400

Blíster

CÓDIGO	MEDIDA	€/BOLSA	PCS BOLSA	BOLSAS
BZACHINB08C	M6 x 45 Ø8	3,350	2	15
BZACHINB10C	M8 x 60 Ø10	3,350	2	15

CH-INN

Cabeza inviolable cincada negra.
Homologado ETE Opt.7



02 Info
P. 289 Técnica

MACIZOS

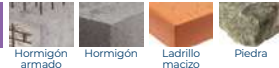

CÓDIGO	MEDIDA	€/100			
ACHINN08C	M6 x 45 Ø8	68,270	TX40	100	1.200
ACHINN08L	M6 x 60 Ø8	76,483	TX40	100	800
ACHINN10C	M8 x 60 Ø10	91,890	TX40	100	600
ACHINN10L	M8 x 80 Ø10	110,360	TX40	100	400



ACCESORIOS PARA CABLE CADENA Y CERCADOS

U

SJ

Sujetacable DIN 741

SJ-Z

Cincado



METAL



CÓDIGO	MÉTRICA	Ø CABLE	€/100		
SJZ0403	M4	3	28,690	200	2.400
SJZ0505	M5	5	33,487	200	1.200
SJZ0506	M5	6 - 6,5	39,398	100	1.200
SJZ0608	M6	8	60,353	100	600
SJZ0810	M8	10	94,932	100	400
SJZ0811	M8	11	105,373	100	400
SJZ1013	M10	13	177,391	50	150
SJZ1014	M10	14	187,870	50	200
SJZ1216	M12	16	283,378	50	100
SJZ1220	M12	20	371,443	25	75
SJZ1422	M14	22	515,677	15	45
SJZ1426	M14	26	635,090	15	45
SJZ1630	M16	30	931,107	10	30
SJZ1634	M16	34	1.215,326	10	20
SJZ1640	M16	40	1.514,058	5	15
SJZ1845	NEW	M18	3.041,807	5	-
SJZ2050	NEW	M20	3.469,283	5	-

Blíster

CÓDIGO	MEDIDA	€/BOLSA	PCS	BOLSAS
BZSJZ0403	3	4,649	4	20
BZSJZ0505	5	4,649	2	20
BZSJZ0506	6 - 6,5	4,649	2	20
BZSJZ0608	8	4,649	2	20

NEW SJ-A4

Inoxidable A4



METAL



CÓDIGO	MÉTRICA	Ø CABLE	€/100		
SJA42103	M4	3	1,951	50	1.200
SJA42305	M5	5	2,570	40	960
SJA42606	M5	6	2,808	20	900
SJA43008	M6	8	2,951	20	480
SJA43410	M8	10	5,235	10	240
SJA43611	M8	11	7,615	10	240
SJA44414	M10	14	8,948	5	225
SJA45016	M12	16	14,230	5	120
SJA45418	M12	18	21,417	5	80
SJA46122	M14	22	30,365	1	-
SJA46525	M14	25	34,029	1	-

NEW SJ-O

Sujetacable oval. Cincado



METAL



CÓDIGO	MÉTRICA	Ø CABLE	€/100		
SJ00502	M5	2	97,405	100	1.200
SJ00503	M5	3	102,043	100	1.200
SJ00604	M6	4	183,214	100	600
SJ00605	M6	5	199,448	100	600
SJ00606	M6	6	216,610	25	150

Sujetacable plano

SJ-P



CÓDIGO	MÉTRICA	Ø CABLE	€/100		
SJPS0402	M4	2	24,119	100	-
SJPS0403	M4	3	24,583	100	-
SJPS0504	M5	4	32,468	100	-
SJPS0605	M6	5	46,383	100	-
SJPS0606	M6	6	64,937	50	-

SJ-PS NEW

Simple. Cincado

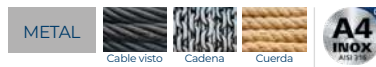

CÓDIGO	MÉTRICA	Ø CABLE	€/100		
SJPSA40403	M4	3	99,946	30	1.350
SJPSA40504	M5	4	147,539	30	1.350
SJPSA40605	M6	5	204,651	20	900
SJPSA40606	M6	6	347,431	10	450

SJ-PS A4 NEW

Simple. Inoxidable A4

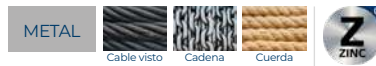

CÓDIGO	MÉTRICA	Ø CABLE	€/100		
SJPD0402	M4	2	35,947	100	2.400
SJPD0403	M4	3	43,600	100	1.200
SJPD0504	M5	4	55,428	100	-
SJPD0605	M5	5	76,533	50	600
SJPD0606	M6	6	118,278	50	300
SJPD0808	M8	8	201,768	25	150

SJ-PD NEW

Doble. Cincado



CÓDIGO	MÉTRICA	Ø CABLE	€/100		
SJPDA40403	M4	3	166,577	30	720
SJPDA40504	M5	4	271,282	30	720
SJPDA40605	M5	5	337,913	20	480
SJPDA40606	M6	6	585,398	10	240

SJ-PD A4 NEW

Doble. Inoxidable A4



TS-GA

Tensor gancho/anilla DIN-1480

TS-GA

Cincado



CÓDIGO	MÉTRICA	Ø CABLE	€/100		
TSGA05 NEW	M5	8	185,533	50	300
TSGA06	M6	10	270,081	50	200
TSGA08	M8	11	349,325	25	100
TSGA10	M10	14	505,792	25	75
TSGA12	M12	17	750,804	10	20
TSGA14	M14	18	986,819	10	20
TSGA16	M16	23	1.486,798	10	20
TSGA20	M20	25	2.553,772	5	-
TSGA22	M22	30	3.565,752	1	-
TSGA24	M24	34	4.742,498	1	-
TSGA30	M30	38	8.522,397	1	-
TSGA36	M36	48	26.036,039	1	-

Blíster

CÓDIGO	MEDIDA	€/BOLSA	PCS BLÍSTER	BOLSAS
BZTSGA06	10	4,649	1	20

NEW TS-GA A4

Inoxidable A4



CÓDIGO	MÉTRICA	Ø CABLE	€/100		
TSGAA405	M5	5	5,092	10	240
TSGAA406	M6	8	7,139	10	120
TSGAA410	M10	12	18,561	5	30
TSGAA412	M12	17	34,981	5	30

TS-AA

Tensor anilla/anilla DIN-1480

NEW TS-AA

Cincado



CÓDIGO	MÉTRICA	Ø CABLE	€/100		
TSAA05	M5	8	185,533	50	300
TSAA06	M6	10	270,081	50	200
TSAA08	M8	11	349,325	25	100
TSAA10	M10	14	505,792	25	75
TSAA12	M12	17	750,804	10	30
TSAA14	M14	18	986,819	10	20
TSAA16	M16	23	1.486,798	10	20
TSAA20	M20	25	2.553,772	5	10
TSAA22	M22	30	3.565,752	1	-
TSAA24	M24	34	4.742,498	1	-
TSAA30	M30	39	8.522,397	1	-
TSAA36	M36	49	26.036,039	1	-

NEW TS-AA A4

Inoxidable A4

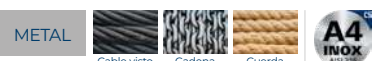

CÓDIGO	MÉTRICA	Ø CABLE	€/100		
TSAAA405	M5	8	5,092	10	240
TSAAA406	M6	10	7,139	10	120
TSAAA408	M8	11	12,517	10	60
TSAAA410	M10	14	18,561	5	20
TSAAA412	M12	17	34,981	5	20

Tensor gancho/gancho DIN-1480

TS-GG

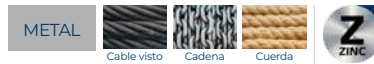

TS-GG NEW

Cincado

CÓDIGO	MÉTRICA	Ø CABLE	€/100		
TSGG05	M5	7	1,855	50	300
TSGG06	M6	8	2,701	50	200
TSGG08	M8	9.5	3,493	25	75
TSGG10	M10	12	5,058	25	75
TSGG12	M12	15	7,508	10	20
TSGG14	M14	17	9,868	10	20
TSGG16	M16	19	14,868	10	20
TSGG20	M20	20	25,538	5	-
TSGG22	M22	23	35,658	1	-
TSGG24	M24	25	47,425	1	-
TSGG30	M30	31	85,224	1	-
TSGG36	M36	44	260,360	1	-

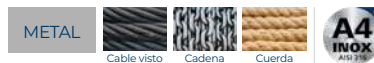

TS-GG A4 NEW

Inoxidable A4

CÓDIGO	MÉTRICA	Ø CABLE	€/100		
TSGGA405	M5	8	5,092	10	240
TSGGA406	M6	10	7,139	10	120
TSGGA408	M8	11	12,517	10	-
TSGGA410	M10	14	18,561	5	20
TSGGA412	M12	17	34,981	5	15



Tensor varilla soldar

TS-VS

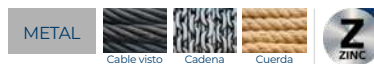

NEW

CÓDIGO	MÉTRICA	Ø CABLE	€/100		
TSVS06	M6	9	2,597	50	100
TSVS08	M8	11	3,154	25	50
TSVS10	M10	13	4,824	25	50
TSVS12	M12	16	6,726	25	50
TSVS14	M12	20	9,323	10	20
TSVS16	M16	24	13,822	10	-
TSVS20	M20	17	23,748	5	-
TSVS22	M22	26	31,262	1	-
TSVS24	M24	28	43,415	1	-
TSVS30	M30	34	67,256	1	-
TSVS36	M36	39	143,788	1	-



EV-H

Cáncamo hembra D-582

EV-H

Cincado



METAL



CÓDIGO	MÉTRICA	Ø CABLE	€/100		
EVH06	M6	20	166,293	100	400
EVH08	M8	20	174,798	100	400
EVH10	M10	25	247,860	100	200
EVH12	M12	30	306,099	100	-
EVH14	M14	35	463,933	50	150
EVH16	M16	35	527,891	50	100
EVH18	M18	40	736,417	50	-
EVH20	M20	40	740,138	50	-
EVH22	M22	45	1.169,235	25	50
EVH24	M24	50	1.487,362	25	-
EVH27	NEW	M28	2.783,000	10	-
EVH30	M30	60	3.048,711	10	20
EVH36	M36	70	4.885,141	1	-
EVH42	NEW	M42	6.957,500	1	-
EVH48	NEW	M48	10.668,167	1	-

NEW EV-H A4

Inoxidable A4



METAL



CÓDIGO	MÉTRICA	Ø CABLE	€/100		
EVHA406	M6	20	209,411	10	450
EVHA408	M8	20	337,913	10	450
EVHA410	M10	25	642,510	10	240
EVHA412	M12	30	951,867	5	120
EVHA414	M14	35	1.427,800	5	120
EVHA416	M16	35	1.665,767	1	-
EVHA420	M20	40	2.189,293	1	-
EVHA424	M24	50	4.759,333	1	-

EV-M

Cáncamo macho D-580

EV-M

Cincado



METAL



CÓDIGO	MÉTRICA	Ø CABLE	€/100		
EVM06	M6	20	166,293	100	400
EVM08	M8	20	174,798	100	400
EVM10	M10	25	247,860	100	200
EVM12	M12	30	306,099	50	100
EVM14	M14	35	463,933	50	100
EVM16	M16	35	527,891	50	-
EVM18	M18	40	736,417	50	-
EVM20	M20	40	740,138	25	50
EVM22	M22	45	1.169,235	25	50
EVM24	M24	50	1.487,362	25	-
EVM27	NEW	M27	2.783,000	10	-
EVM30	M30	60	3.048,711	10	-
EVM33	NEW	M33	4.174,500	1	-
EVM36	M36	70	4.885,141	1	-
EVM42	M42	80	6.957,500	1	-
EVM48	M48	90	10.668,167	1	-

NEW EV-M A4

Inoxidable A4



METAL



CÓDIGO	MÉTRICA	Ø CABLE	€/100		
EVMA406	M6	20	223,689	10	450
EVMA408	M8	20	385,506	10	450
EVMA410	M10	25	690,103	10	240
EVMA412	M12	30	1.047,053	5	120
EVMA414	M14	35	1.546,783	5	120
EVMA416	M16	35	1.808,547	1	-
EVMA420	M20	40	2.617,633	1	-
EVMA424	M24	50	5.711,200	1	-

Grillete recto

GR

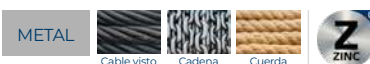

GR-Z

Cincado

CÓDIGO	MÉTRICA	Ø CABLE	€/100		
GRZ05	M5	10	94,563	50	1.200
GRZ06	M6	12	99,267	50	600
GRZ08	M8	16	131,976	50	300
GRZ10	M10	19	182,307	50	200
GRZ11	M11	22	289,575	25	150
GRZ12	M12	25	292,843	25	100
GRZ14	M14	28	449,013	25	75
GRZ16	M16	32	605,570	10	40
GRZ18	M18	36	920,170	5	30
GRZ20	M20	38	1.013,740	5	20
GRZ22	M22	44	1.436,570	1	-
GRZ25	M25	50	2.101,407	1	-
GRZ28	M28	56	3.157,168	1	-
GRZ32	M32	64	5.156,760	1	-
GRZ36	M36	70	8.821,230	1	-
GRZ38	NEW M38	76	7.885,167	1	-
GRZ42	M42	76	16.500,303	1	-
GRZ45	M45	80	21.931,776	1	-
GRZ50	M50	90	28.796,829	1	-
GRZ56	NEW M56	100	52.877,000	1	-
GRZ63	NEW M63	110	86.504,917	1	-



Blíster

CÓDIGO	MEDIDA	€/BOLSA	PCS	BOLSAS
BZGRZ05	10	4,649	4	20
BZGRZ06	12	4,649	4	20
BZGRZ08	16	4,649	2	20
BZGRZ10	19	4,649	1	20

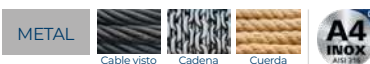

GR-A4 NEW

Inoxidable A4

CÓDIGO	MÉTRICA	Ø CABLE	€/100		
GRA404	M4	8	209,411	25	1.125
GRA405	M5	10	228,448	25	1.125
GRA406	M6	12	261,763	25	600
GRA408	M8	16	390,265	10	240
GRA410	M10	19	628,232	10	120
GRA412	M12	25	989,941	5	60
GRA414	M14	28	1.594,377	5	60
GRA416	M16	32	2.284,480	5	40
GRA419	M20	38	4.473,773	1	-
GRA425	M25	50	9.613,853	1	-



GD

Guardacabo DIN-6899/A

GD-Z

Cincado

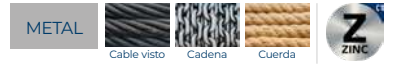

CÓDIGO	MÉTRICA	Ø CABLE	€/100		
GDZ03	M3	12	35,769	200	2.400
GDZ04	M4	13	36,597	200	1.200
GDZ05	M5	14	41,649	200	600
GDZ06	M6	15	46,782	200	-
GDZ08	M8	18	57,317	100	200
GDZ10	M10	22	80,183	100	200
GDZ12	NEW M12	26	106,682	100	600
GDZ13	M13	28	176,212	50	-
GDZ15	M15	32	254,457	50	-
GDZ18	M18	40	588,253	50	-
GDZ20	M20	44	845,997	25	-
GDZ24	M24	48	1.051,407	10	20

Blíster

CÓDIGO	MEDIDA	€/BOLSA	PCS BLÍSTER	BOLSAS
BZGDZ03	12	4,649	6	20
BZGDZ04	13	4,649	4	20
BZGDZ05	14	4,649	4	20
BZGDZ06	15	4,649	4	20

NEW GD-A4

Inoxidable A4

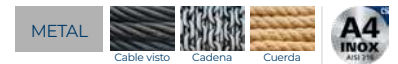

CÓDIGO	MÉTRICA	Ø CABLE	€/100		
GDA402	M2	10	39,502	100	4.500
GDA403	M3	12	57,112	100	4.500
GDA404	M4	13	66,631	50	2.250
GDA405	M5	14	90,427	50	1.200
GDA406	M6	15	104,705	50	1.200
GDA408	M8	18	199,892	50	600
GDA410	M10	22	328,394	25	300
GDA412	M12	26	385,506	10	120
GDA415	M15	32	666,307	5	60

GI

Grillete lira

NEW GI-Z

Cincado



CÓDIGO	MÉTRICA	Ø CABLE	€/100		
GIZ36	M36	78	6.887,925	1	-
GIZ05	M5	8	69,575	50	1.200
GIZ06	M6	10	74,213	50	600
GIZ08	M8	12	120,597	50	300
GIZ10	M10	16	190,172	50	200
GIZ11	M11	19	255,108	25	150
GIZ12	M12	28	287,577	25	100
GIZ14	M14	33	445,280	10	60
GIZ16	M16	37	616,898	10	40
GIZ20	M20	40	1.113,200	5	30
GIZ22	M22	47	1.484,267	1	-
GIZ25	M25	52	2.087,250	1	-
GIZ28	M28	63	3.154,067	1	-
GIZ32	M32	75	5.148,550	1	-

Grillete lira

GI

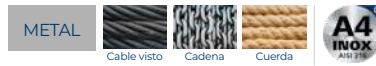

GI-A4 NEW

Inoxidable A4



CÓDIGO	MÉTRICA	Ø CABLE	€/100		
GI A404	M4	6	266,523	25	1.125
GI A405	M5	8	290,319	25	1.125
GI A406	M6	10	318,875	10	450
GI A408	M8	12	475,933	10	240
GI A410	M10	16	785,290	10	120
GI A412	M12	28	1.237,427	5	60
GI A414	M14	33	2.141,700	5	60
GI A416	M16	37	2.926,990	5	30

Ese cincada

GS NEW

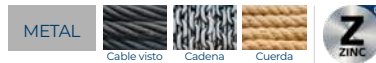

CÓDIGO	MÉTRICA	Ø CABLE	€/100		
GSZ0325	M3	7	11,596	200	-
GSZ0435	M4	11	13,451	200	-
GSZ0545	M5	14	24,583	200	-
GSZ0655	M6	16	37,571	100	-
GSZ0765	M7	20	71,430	50	-
GSZ0875	M8	23	104,363	50	-
GSZ1010	M10	25	183,214	25	-

Mosquetón bombero

MQ



MQ-BS NEW

Con seguro



CÓDIGO	MÉTRICA	Ø CABLE	€/100		
MQBS04	M4	6	106,682	200	2.400
MQBS06	M6	9	139,150	100	600
MQBS07	M7	10	171,618	100	400
MQBS08	M8	12	190,172	50	300
MQBS09	M9	15	264,385	25	150
MQBS10	M10	14,7	320,045	25	150
MQBS11	M11	18	436,003	25	100
MQBS12	M12	20	635,452	10	60

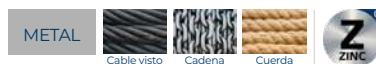

MQ-B NEW

Mosquetón bombero



CÓDIGO	MÉTRICA	Ø CABLE	€/100		
MQB04	M4	6	69,575	100	2.400
MQB05	M5	8	71,894	100	1.200
MQB06	M6	9	88,128	100	600
MQB07	M7	10	113,639	100	600
MQB08	M8	12	139,150	50	300
MQB09	M9	15	193,882	25	150
MQB10	M10	15	231,917	25	150
MQB11	M11	18	347,875	10	120
MQB12	M12	20	426,727	10	60
MQB14	M14	25	960,135	10	40
MQB15	M15	26	1.345,117	10	30

CM

Accesorios para cercado

CM-BP

Brida poste

METAL



CÓDIGO	MEDIDA	€/100	
CMBRPOS33	33-35	182,317	250
CMBRPOS40	40-43	199,838	200
CMBRPOS42	42-45	203,029	200
CMBRPOS48	48-52	210,064	200
CMBRPOS50	50-53	221,236	200
CMBRPOS60	60-62	230,052	150

CM-BT

Brida tensor

METAL



CÓDIGO	MEDIDA	€/100	
CMBRTEN48	48	357,073	200

CM-TA

Tapón

METAL



CÓDIGO	MEDIDA	€/100	
CMTAPON33	33	84,433	500
CMTAPON40	40	92,693	350
CMTAPON42	42	96,247	350
CMTAPON48	48	106,940	300
CMTAPON50	50	119,257	250
CMTAPON60	60	138,357	250

CM-TP

Tapón poste

METAL



CÓDIGO	MEDIDA	€/100	
CMTAPOS33	33	228,137	100
CMTAPOS40	40	239,403	200
CMTAPOS42	42	240,103	200
CMTAPOS48	48	264,593	150

CM-UN

Uña

METAL



CÓDIGO	MEDIDA	€/100	
CMUNAAGUJ	Con agujero	26,373	1.500

Tensores para cercado

CM-T

METAL



CM-TENSO

Tensor de alambre

CÓDIGO	MEDIDA	€/100	
CMTENSOAL	85 x 29,5	126,497	250



METAL



CM-TENSOVE

Tensor de alambre verde

CÓDIGO	MEDIDA	€/100	
CMTENSOVE	85 x 29,5	197,603	250



METAL



CM-TT

Tensor de tornillo

CÓDIGO	MEDIDA	€/100	
CMTENSOTO	Tornillo	119,120	450





FIJACIÓN DIRECTA



FG-GUN

Pistola semiautomática de fijación a gas sin cables

GAS

FG-GUN

Pistola semiautomática de fijación a gas sin cables para tabiquería seca

CÓDIGO	MEDIDA	€/PC	
FG60GUN	Pistola gas / Gas gun / Pistolet gaz	2.160,000	1



CONTENIDO MALETÍN

- Pistola de fijación a gas
- Cargador
- 2 baterías
- Llave Allen
- Manual de instrucciones

PISTOLA SUMINISTRADA CON MALETÍN COMPLETO

- Técnica de anclaje directo para fijaciones ligeras: organizar cableados, colocar perfiles metálicos para la instalación de tabiques de placas de yeso, etc.
- Fijación de metal o madera a hormigón o bloque.
- Pistola suministrada con completo maletín, incluyendo cargador de batería.
- Baterías de larga duración.
- Capacidad para clavos de hasta 40 mm. de longitud.
- Carga de gas suministrada con los consumibles.

FG-GUNEL

Pistola semiautomática de fijación a gas sin cables para electricistas

GAS

CÓDIGO	MEDIDA	€/PC	
FG60GUNEL	Pistola gas / Gas gun / Pistolet gaz	2.233,333	1



CONTENIDO MALETÍN

- Pistola de fijación a gas
- Cargador
- 2 baterías
- Llave Allen
- Manual de instrucciones
- Cañón para electricistas

Clavos para pistola de fijación a gas

FG-CL





CÓDIGO	MEDIDA	€/100	
FGCL15	2,6 x 15	12,277	1.000
FGCL20	2,6 x 20	12,657	1.000
FGCL25	2,6 x 25	12,863	1.000
FGCL30	2,6 x 30	12,987	1.000
FGCL35	2,6 x 35	14,163	1.000
FGCL40	2,6 x 40	15,227	1.000

FG-CL

Clavos estándar



CÓDIGO	MEDIDA	€/100		
FGCLH15	3,1 x 15	13,980	1.000	-
FGCLH17	3,1 x 17	14,257	1.000	5.000
FGCLH19	3,1 x 19	14,257	1.000	-
FGCLH22	3,1 x 22	14,257	1.000	-
FGCLH27	3,1 x 27	14,917	1.000	-
FGCLH32	3,1 x 32	15,440	1.000	-

FG-CLH



Clavos para materiales duros



Accesorios para instalar con pistola de gas

FG-AC



CÓDIGO	MEDIDA	€/100		
FGARAM25	Ø25	19,217	200	4.800

FG-ARAM

Arandela metálica



CÓDIGO	MEDIDA	€/PC	
FGARAM25EP	Ø25	180,637	1

FG-ARAM EP

Arandela metálica. Bote de plástico



FP-CL08

Clavos para pistola FP08 a pólvora

FG-PLET

Pletina roscada para varilla



CÓDIGO	MEDIDA	€/100		
FGPLET	M6 - M8	159,763	100	400

AB-PID

Grapa 1 pie para disparo



CÓDIGO	MEDIDA	€/100		
ABPID016	16	12,877	100	1.200
ABPID020	20	19,920	100	1.200
ABPID025	25	23,343	100	600
ABPID032	32	28,977	100	600

FG-ABRA

Abrazadera a presión



CÓDIGO	MEDIDA	€/100		
FGABRA15	15 - 18	59,577	100	-
FGABRA20	20 - 25	62,960	50	200
FGABRA25	25 - 32	75,703	50	-

INSTALACIÓN

PISTOLA



FG-BASE

Base para brida



CÓDIGO	COLOR	€/100		
FGBASEGR	GRIS	16,660	100	1.200
FGBASENE	NEGRO	16,173	100	1.200

Accesorios para pistola de gas

FG-APG



CÓDIGO	MEDIDA	€/PC	
FGCAEL	11	200,000	1

FG-CAEL

Cañón de pistola especial para electricistas



CÓDIGO	MEDIDA	€/PC	
FGCLCAR40	40	305,927	1

FG-CLCAR

Cargador para 40 clavos



CÓDIGO	MEDIDA	€/PC	
FGIMAN	Øinterior 11,25	151,107	1

FG-IMAN

Imán



CÓDIGO	€/PC	
FG60BAT	380,653	1

FG-BAT

Batería para pistola FP60GUN



CÓDIGO	€/PC	
FG60CAR	299,025	1

FG-CAR

Cargador para pistola FP60GUN



CÓDIGO	MEDIDA	€/PC		
FG60GAS	70 ml.	32,570	1	12

FG-GAS

Cartucho de gas





TORNILLERÍA



DIN-7504-K

Tornillo autotaladrante de cabeza hexagonal

DIN-7504-K

Tornillo



Disponible en diferentes colores



Disponible en varios recubrimientos. Consulte precio y plazo de entrega.



CÓDIGO	MEDIDA	€/100				CÓDIGO	MEDIDA	€/100			
ABE3509	3,5 x 9,5	2,560	6	1.000	24.000	ABE5563	5,5 x 63	15,793	8	250	1.000
ABE3513	3,5 x 13	2,644	6	1.000	12.000	ABE5575	5,5 x 75	19,141	8	250	1.500
ABE3516	3,5 x 16	3,010	6	1.000	12.000	ABE6319	6,3 x 19	10,923	10	500	3.000
ABE3519	3,5 x 19	3,167	6	1.000	12.000	ABE6325	6,3 x 25	11,577	10	500	3.000
ABE4213	4,2 x 13	3,650	7	1.000	12.000	ABE6332	6,3 x 32	13,430	10	500	2.000
ABE4216	4,2 x 16	3,890	7	1.000	8.000	ABE6338	6,3 x 38	15,080	10	500	2.000
ABE4219	4,2 x 19	4,383	7	1.000	8.000	ABE6350	6,3 x 50	18,498	10	250	1.500
ABE4225	4,2 x 25	5,209	7	500	6.000	ABE6363	6,3 x 63	21,867	10	250	1.500
ABE4232	4,2 x 32	5,988	7	500	6.000	ABE6375	6,3 x 75	25,857	10	250	1.000
ABE4238	4,2 x 38	6,813	7	500	6.000	ABE6380	6,3 x 80	28,760	10	250	1.000
ABE4813	4,8 x 13	4,730	8	1.000	8.000	ABE6390	6,3 x 90	33,868	10	250	750
ABE4816	4,8 x 16	4,870	8	1.000	6.000	ABE6310	6,3 x 100	36,391	10	100	600
ABE4819	4,8 x 19	5,417	8	500	6.000	ABE6311	6,3 x 110	44,044	10	100	600
ABE4825	4,8 x 25	6,113	8	500	6.000	ABE6312	6,3 x 120	51,937	10	100	600
ABE4832	4,8 x 32	7,490	8	500	3.000	ABE6313	6,3 x 130	57,637	10	100	600
ABE4838	4,8 x 38	8,403	8	500	3.000	ABE6314	6,3 x 140	67,376	10	100	600
ABE5519	5,5 x 19	7,147	8	500	6.000	ABE6315	6,3 x 150	81,241	10	100	600
ABE5522	5,5 x 22	7,437	8	500	4.000	ABE6316	6,3 x 160	90,188	10	100	400
ABE5525	5,5 x 25	7,809	8	500	4.000	ABE6318	6,3 x 180	116,703	10	100	300
ABE5532	5,5 x 32	9,396	8	500	3.000	ABE6320	6,3 x 200	147,377	10	100	300
ABE5538	5,5 x 38	10,667	8	500	3.000	ABE6322	6,3 x 220	188,620	10	100	200
ABE5550	5,5 x 50	12,896	8	500	2.000	ABE6324	6,3 x 240	213,017	10	100	200

Blíster

CÓDIGO	MEDIDA	€/BOLSA	PCS	BOLSAS
BZABE3509	3,5 x 9,5	2,561	20	20
BZABE3513	3,5 x 13	2,561	20	20
BZABE4213	4,2 x 13	2,561	20	20
BZABE4216	4,2 x 16	2,561	20	20
BZABE4219	4,2 x 19	2,561	20	20
BZABE4225	4,2 x 25	2,561	10	20
BZABE4813	4,8 x 13	2,561	20	20
BZABE4816	4,8 x 16	2,561	20	20
BZABE4819	4,8 x 19	2,561	10	20
BZABE4825	4,8 x 25	2,561	10	20
BZABE4832	4,8 x 32	2,561	10	20
BZABE4838	4,8 x 38	2,561	10	20
BZABE5519	5,5 x 19	2,561	10	20
BZABE5522	5,5 x 22	2,561	10	20
BZABE5525	5,5 x 25	2,561	10	20
BZABE5532	5,5 x 32	2,561	10	20
BZABE5538	5,5 x 38	2,561	10	20
BZABE5550	5,5 x 50	2,561	10	20
BZABE6325	6,3 x 25	2,561	10	20
BZABE6332	6,3 x 32	2,561	10	20
BZABE6338	6,3 x 38	2,561	10	20
BZABE6350	6,3 x 50	2,561	5	20

Caja ventana

CÓDIGO	MEDIDA	€/CAJA	PCS	CAJAS
VABE3509	3,5 x 9,5	6,357	225	8
VABE3513	3,5 x 13	6,580	200	8
VABE4213	4,2 x 13	6,557	150	8
VABE4216	4,2 x 16	7,175	150	8
VABE4219	4,2 x 19	8,222	150	8
VABE4225	4,2 x 25	4,924	75	8
VABE4232	4,2 x 32	5,997	75	8
VABE4813	4,8 x 13	8,804	150	8
VABE4816	4,8 x 16	9,448	150	8
VABE4819	4,8 x 19	10,298	150	8
VABE4825	4,8 x 25	11,617	150	8
VABE4832	4,8 x 32	9,648	110	8
VABE4838	4,8 x 38	8,520	85	8
VABE5519	5,5 x 19	10,874	125	8
VABE5522	5,5 x 22	11,430	125	8
VABE5525	5,5 x 25	12,607	125	8
VABE5532	5,5 x 32	9,933	85	8
VABE5538	5,5 x 38	10,405	80	8
VABE5550	5,5 x 50	9,428	60	8
VABE5563	5,5 x 63	7,572	40	8
VABE6319	6,3 x 19	13,063	100	8
VABE6325	6,3 x 25	13,063	90	8
VABE6332	6,3 x 32	12,015	70	8
VABE6338	6,3 x 38	11,142	60	8
VABE6350	6,3 x 50	9,050	40	8
VABE6363	6,3 x 63	6,923	25	8

DIN-7504-K A2

Tornillo. Inoxidable A2



CÓDIGO	MEDIDA	€/100			
ABEI4213	4,2 x 13	18,393	7	1.000	12.000
ABEI4216	4,2 x 16	20,637	7	1.000	8.000
ABEI4219	4,2 x 19	21,390	7	1.000	8.000
ABEI4813	4,8 x 13	26,023	8	1.000	8.000
ABEI4816	4,8 x 16	25,427	8	500	6.000
ABEI4819	4,8 x 19	27,513	8	500	6.000
ABEI4825	4,8 x 25	30,810	8	500	6.000
ABEI4832	4,8 x 32	36,633	8	500	3.000
ABEI5519	5,5 x 19	37,987	8	500	6.000
ABEI5522	5,5 x 22	40,527	8	500	4.000
ABEI5525	5,5 x 25	43,070	8	500	6.000
ABEI6319	6,3 x 19	57,573	10	500	3.000
ABEI6325	6,3 x 25	65,500	10	500	3.000



Tornillo autotaladrante de cabeza hexagonal



DIN-7504-K



DIN-7504-K + ARVUL

Tornillo con arandela vulcanizada de acero-EPDM

CÓDIGO	MEDIDA	€/100			
ABE144219	4,2 x 19 P14	9,813	7	1.000	4.000
ABE164219	4,2 x 19 P16	13,013	7	1.000	4.000
ABE144225	4,2 x 25 P14	12,783	7	500	3.000
ABE144816	4,8 x 16 P14	9,725	8	1.000	4.000
ABE164816	4,8 x 16 P16	10,620	8	1.000	4.000
ABE144819	4,8 x 19 P14	9,020	8	1.000	4.000
ABE164819	4,8 x 19 P16	10,213	8	1.000	3.000
ABE184819	4,8 x 19 P18	15,922	8	500	3.000
ABE144825	4,8 x 25 P14	11,190	8	1.000	4.000
ABE164825	4,8 x 25 P16	11,097	8	1.000	3.000
ABE184825	4,8 x 25 P18	16,895	8	500	3.000
ABE144832	4,8 x 32 P14	16,163	8	500	3.000
ABE164832	4,8 x 32 P16	14,280	8	500	3.000
ABE144838	4,8 x 38 P14	17,780	8	500	3.000
ABE164838	4,8 x 38 P16	14,650	8	500	2.000
ABE184838	4,8 x 38 P18	19,437	8	500	2.000
ABE165519	5,5 x 19 P16	12,223	8	1.000	3.000
ABE145522	5,5 x 22 P14	13,457	8	1.000	4.000
ABE165522	5,5 x 22 P16	12,333	8	1.000	3.000
ABE185522	5,5 x 22 P18	16,690	8	500	3.000
ABE255522	5,5 x 22 P25	20,662	8	500	1.500
ABE165525	5,5 x 25 P16	13,346	8	1.000	3.000
ABE185525	5,5 x 25 P18	18,213	8	500	3.000
ABE255525	5,5 x 25 P25	23,719	8	500	1.500
ABE145532	5,5 x 32 P14	17,037	8	1.000	3.000
ABE165532	5,5 x 32 P16	14,163	8	1.000	2.000
ABE185532	5,5 x 32 P18	19,277	8	500	2.000
ABE165538	5,5 x 38 P16	16,194	8	1.000	2.000
ABE185538	5,5 x 38 P18	20,580	8	500	2.000
ABE165550	5,5 x 50 P16	18,361	8	500	1.500
ABE185550	5,5 x 50 P18	24,111	8	500	1.500
ABE165563	5,5 x 63 P16	22,947	8	250	1.500
ABE185563	5,5 x 63 P18	25,552	8	250	1.000
ABE165575	5,5 x 75 P16	26,883	8	250	1.000
ABE166319	6,3 x 19 P16	17,349	10	500	3.000
ABE186319	6,3 x 19 P18	18,843	10	500	3.000
ABE166325	6,3 x 25 P16	16,393	10	500	2.000

CÓDIGO	MEDIDA	€/100			
ABE186325	6,3 x 25 P18	19,107	10	500	2.000
ABE256325	6,3 x 25 P25	26,114	10	500	1.500
ABE166332	6,3 x 32 P16	20,330	10	500	2.000
ABE186332	6,3 x 32 P18	22,710	10	500	2.000
ABE256332	6,3 x 32 P25	28,792	10	500	1.000
ABE166338	6,3 x 38 P16	21,677	10	500	2.000
ABE186338	6,3 x 38 P18	24,311	10	250	1.500
ABE256338	6,3 x 38 P25	31,353	10	250	750
ABE166350	6,3 x 50 P16	24,967	10	500	1.000
ABE186350	6,3 x 50 P18	27,094	10	250	1.000
ABE256350	6,3 x 50 P25	35,960	10	250	750
ABE166363	6,3 x 63 P16	31,102	10	250	1.000
ABE186363	6,3 x 63 P18	31,587	10	250	1.000
ABE256363	6,3 x 63 P25	36,510	10	100	600
ABE166375	6,3 x 75 P16	33,600	10	250	750
ABE186375	6,3 x 75 P18	35,140	10	250	750
ABE166380	6,3 x 80 P16	39,990	10	100	600
ABE186380	6,3 x 80 P18	41,320	10	100	600
ABE256380	6,3 x 80 P25	47,287	10	100	300
ABE166390	6,3 x 90 P16	46,633	10	100	600
ABE186390	6,3 x 90 P18	42,075	10	100	600
ABE256390	6,3 x 90 P25	50,367	10	100	400
ABE166310	6,3 x 100 P16	48,680	10	100	600
ABE186310	6,3 x 100 P18	48,797	10	100	400
ABE256310	6,3 x 100 P25	54,320	10	100	400
ABE166311	6,3 x 110 P16	55,583	10	100	600
ABE186311	6,3 x 110 P18	57,300	10	100	400
ABE256311	6,3 x 110 P25	59,243	10	100	300
ABE166312	6,3 x 120 P16	63,937	10	100	400
ABE186312	6,3 x 120 P18	66,217	10	100	400
ABE256312	6,3 x 120 P25	68,573	10	100	300
ABE166313	6,3 x 130 P16	70,373	10	100	400
ABE186313	6,3 x 130 P18	79,957	10	100	400
ABE256313	6,3 x 130 P25	75,147	10	100	300
ABE166314	6,3 x 140 P16	78,080	10	100	400
ABE186314	6,3 x 140 P18	83,630	10	100	400
ABE256314	6,3 x 140 P25	82,170	10	100	200



Disponible en diferentes colores

Disponible en varios recubrimientos. Consulte precio y plazo de entrega.



Blíster

CÓDIGO	MEDIDA	€/BOLSA	PCS	BOLSAS
BZABE144819	4,8 x 19 P14	2,561	18	10
BZABE164819	4,8 x 19 P16	2,561	18	10
BZABE144825	4,8 x 25 P14	2,561	18	10
BZABE165522	5,5 x 22 P14	2,561	15	10
BZABE165525	5,5 x 25 P16	2,561	15	10
BZABE165532	5,5 x 32 P14	2,561	12	10
BZABE165538	5,5 x 38 P16	2,561	12	10
BZABE165550	5,5 x 50 P16	2,561	10	10
BZABE166325	6,3 x 25 P16	2,561	10	10
BZABE166332	6,3 x 32 P16	2,561	8	10
BZABE166338	6,3 x 38 P16	2,561	8	10



Caja ventana

CÓDIGO	MEDIDA	€/CAJA	PCS	CAJAS
VABE144819	4,8 x 19 P14	12,001	100	8
VABE164819	4,8 x 19 P16	8,767	70	8
VABE144825	4,8 x 25 P14	10,638	80	8
VABE165522	5,5 x 22 P14	9,861	70	8
VABE165525	5,5 x 25 P16	10,039	60	8
VABE165532	5,5 x 32 P14	8,673	50	8
VABE165538	5,5 x 38 P16	8,833	45	8
VABE165550	5,5 x 50 P16	7,771	35	8
VABE166325	6,3 x 25 P16	9,622	50	8
VABE166332	6,3 x 32 P16	12,280	50	8
VABE166338	6,3 x 38 P16	10,465	40	8



DIN-7504-K CP + ARVUL

Bote de plástico

CÓDIGO	MEDIDA	€/UD		
ABE144819CP	4,8 x 19 P14	125,372	8	1
ABE164819CP	4,8 x 19 P16	132,113	8	1
ABE165522CP	5,5 x 22 P16	159,356	8	1
ABE166325CP	6,3 x 25 P16	128,199	10	1



AUE

Tornillo rosca chapa con cabeza hexagonal

AUE

Tornillo



Disponible en diferentes colores



Disponible en varios recubrimientos. Consulte precio y plazo de entrega.

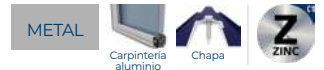

CÓDIGO	MEDIDA	€/100			
AUE6319	6,3 x 19	9,413	10	500	3.000
AUE6325	6,3 x 25	10,911	10	500	3.000
AUE6332	6,3 x 32	12,090	10	500	2.000
AUE6340	6,3 x 40	14,432	10	500	2.000
AUE6350	6,3 x 50	16,611	10	500	1.500
AUE6360	6,3 x 60	19,541	10	250	1.000
AUE6380	6,3 x 80	25,632	10	250	1.000
AUE6310	6,3 x 100	32,713	10	250	750
AUE6311	6,3 x 110	39,557	10	250	750
AUE6312	6,3 x 120	43,120	10	250	750
AUE6313	6,3 x 130	53,014	10	250	750
AUE6314	6,3 x 140	59,510	10	250	500
AUE6315	6,3 x 150	73,147	10	100	400

AUE + ARVUL

Tornillo con arandela vulcanizada de acero-EPDM



Disponible en diferentes colores



Disponible en varios recubrimientos. Consulte precio y plazo de entrega.





CÓDIGO	MEDIDA	€/100			
AUE166319	6,3 x 19 P16	16,973	10	500	2.000
AUE166325	6,3 x 25 P16	17,980	10	500	2.000
AUE186325	6,3 x 25 P18	20,217	10	500	2.000
AUE256325	6,3 x 25 P25	30,867	10	500	1.500
AUE166332	6,3 x 32 P16	20,157	10	500	2.000
AUE186332	6,3 x 32 P18	22,623	10	500	1.500
AUE166340	6,3 x 40 P16	22,160	10	500	1.500
AUE186340	6,3 x 40 P18	26,710	10	500	1.500
AUE166350	6,3 x 50 P16	25,493	10	500	1.500
AUE186350	6,3 x 50 P18	27,783	10	500	1.500
AUE166360	6,3 x 60 P16	30,133	10	250	1.000
AUE186360	6,3 x 60 P18	32,580	10	250	1.000
AUE166380	6,3 x 80 P16	38,450	10	250	750
AUE186380	6,3 x 80 P18	42,233	10	250	750
AUE186310	6,3 x 100 P18	49,310	10	250	750
AUE186311	6,3 x 110 P18	55,883	10	250	500
AUE186312	6,3 x 120 P18	64,277	10	100	400
AUE186313	6,3 x 130 P18	75,133	10	100	400
AUE186314	6,3 x 140 P18	81,550	10	100	400
AUE186315	6,3 x 150 P18	83,530	10	100	400

Arandela vulcanizada de acero-EPDM

ARVUL

METAL



CÓDIGO	MEDIDA	€/100	Ø INTERIOR ARANDELA		
ARANE14	P14	4,515	2.5	1.000	12.000
ARANE16	P16	5,164	2.7	1.000	6.000
ARANE18	P18	6,790	3.2	1.000	6.000
ARANE25	P25	12,127	3.3	500	3.000

ARVUL

Recubrimiento ATLANTIS C2-M

 Blíster



CÓDIGO	MEDIDA	€/BOLSA	PCS BOLSAS	
BZARANE14	P14	2,024	20	10
BZARANE16	P16	2,024	20	10
BZARANE18	P18	2,024	20	10

 Caja ventana

CÓDIGO	MEDIDA	€/CAJA	PCS CAJAS	
VARANE14	P14	5,520	100	8
VARANE16	P16	6,124	100	8
VARANE18	P18	8,034	100	8
VARANE25	P25	13,914	100	8

INOXIDABLE



CÓDIGO	MEDIDA	€/100	Ø INTERIOR ARANDELA		
ARINO14	P14	13,167	2.5	1.000	12.000
ARINO16	P16	14,887	2.7	1.000	6.000
ARINO18	P18	18,733	3.2	1.000	6.000
ARINO25	P25	34,640	3.3	500	3.000
ARINOM30	P30	54,033	6.3	500	1.500

ARVUL A2



Inoxidable A2



TP-PO B

Bicromatado. Huella PZ



CÓDIGO	MEDIDA	€/100		LONGITUD DE LA ROSCA	UD. MIN. VENTA		
• TPP025010	2,5 x 10	1,228	PZ1	Total	2.000	1.000	45.000
• TPP025012	2,5 x 12	1,235	PZ1	Total	2.000	1.000	45.000
• TPP025016	2,5 x 16	1,385	PZ1	Total	2.000	1.000	45.000
TPP025020	2,5 x 20	1,550	PZ1	Total	2.000	1.000	24.000
TPP025025	2,5 x 25	1,693	PZ1	Total	2.000	1.000	24.000
• TPP030012	3 x 12	1,098	PZ1	Total	2.000	1.000	45.000
• TPP030016	3 x 16	1,280	PZ1	Total	2.000	1.000	24.000
• TPP030020	3 x 20	1,440	PZ1	Total	2.000	1.000	24.000
TPP030025	3 x 25	1,673	PZ1	Total	2.000	1.000	12.000
TPP030030	3 x 30	1,803	PZ1	Total	2.000	1.000	12.000
TPP030040	3 x 40	2,447	PZ1	Total	2.000	1.000	6.000
• TPP035016	3,5 x 16	1,410	PZ2	Total	2.000	1.000	24.000
• TPP035020	3,5 x 20	1,709	PZ2	Total	2.000	1.000	12.000
TPP035025	3,5 x 25	1,930	PZ2	Total	2.000	1.000	12.000
TPP035030	3,5 x 30	2,165	PZ2	Total	2.000	1.000	12.000
TPP035035	3,5 x 35	2,653	PZ2	Total	1.000	500	6.000
TPP035040	3,5 x 40	2,883	PZ2	Total	1.000	500	6.000
TPP035050	3,5 x 50	3,773	PZ2	Total	500	250	3.000
• TPP040016	4 x 16	1,818	PZ2	Total	2.000	1.000	16.000
• TPP040020	4 x 20	2,160	PZ2	Total	2.000	1.000	12.000
• TPP040025	4 x 25	2,410	PZ2	Total	2.000	1.000	12.000
TPP040030	4 x 30	2,863	PZ2	Total	1.000	500	6.000
TPP040035	4 x 35	3,231	PZ2	Total	1.000	500	6.000
TPP040040	4 x 40	3,376	PZ2	Total	1.000	500	6.000
TPP040045	4 x 45	4,256	PZ2	Total	1.000	500	3.000
TPP040050	4 x 50	4,700	PZ2	Total	500	250	3.000
TPP040060	4 x 60	5,389	PZ2	Total	500	250	3.000
TPP040070	4 x 70	6,640	PZ2	Parcial 52	500	250	3.000
• TPP045020	4,5 x 20	2,730	PZ2	Total	1.000	500	12.000
• TPP045025	4,5 x 25	3,240	PZ2	Total	1.000	500	6.000
• TPP045030	4,5 x 30	3,635	PZ2	Total	1.000	500	6.000
TPP045035	4,5 x 35	3,997	PZ2	Total	1.000	500	6.000
TPP045040	4,5 x 40	4,410	PZ2	Total	1.000	500	3.000
TPP045045	4,5 x 45	5,389	PZ2	Total	500	250	3.000
TPP045050	4,5 x 50	5,800	PZ2	Total	500	250	3.000
TPP045060	4,5 x 60	6,833	PZ2	Total	500	250	3.000
TPP045070	4,5 x 70	8,353	PZ2	Parcial 52	500	250	1.500
TPP045080	4,5 x 80	9,952	PZ2	Parcial 52	200	100	1.200
• TPP050020	5 x 20	3,363	PZ2	Total	1.000	500	6.000
• TPP050025	5 x 25	4,007	PZ2	Total	1.000	500	6.000
• TPP050030	5 x 30	4,530	PZ2	Total	500	250	6.000
TPP050035	5 x 35	5,113	PZ2	Total	500	250	3.000
TPP050040	5 x 40	5,613	PZ2	Total	500	250	3.000
TPP050045	5 x 45	6,250	PZ2	Total	500	250	3.000
TPP050050	5 x 50	6,847	PZ2	Total	500	250	3.000
TPP050060	5 x 60	8,237	PZ2	Total	500	250	1.500
TPP050070	5 x 70	10,300	PZ2	Parcial 52	200	100	1.200
TPP050080	5 x 80	11,632	PZ2	Parcial 52	200	100	1.200
TPP050090	5 x 90	13,960	PZ2	Parcial 60	200	100	1.200
TPP050100	5 x 100	14,918	PZ2	Parcial 60	200	100	1.200
TPP050120	5 x 120	21,927	PZ2	Parcial 75	200	100	1.200
• TPP060040	6 x 40	8,490	PZ3	Total	500	250	3.000
TPP060050	6 x 50	9,783	PZ3	Total	500	250	1.500
TPP060060	6 x 60	11,390	PZ3	Total	500	250	1.500
TPP060070	6 x 70	14,763	PZ3	Parcial 52	200	100	1.200
TPP060080	6 x 80	16,753	PZ3	Parcial 52	200	100	1.200
TPP060090	6 x 90	18,397	PZ3	Parcial 60	200	100	1.200
TPP060100	6 x 100	21,697	PZ3	Parcial 60	100	100	1.200
TPP060110	6 x 110	25,395	PZ3	Parcial 70	100	100	600
TPP060120	6 x 120	27,005	PZ3	Parcial 70/75	100	100	600
TPP060130	6 x 130	32,000	PZ3	Parcial 70/75	100	100	600
TPP060140	6 x 140	35,642	PZ3	Parcial 70/75	100	100	600
TPP060150	6 x 150	38,547	PZ3	Parcial 70/75	100	100	600
TPP060160	6 x 160	42,941	PZ3	Parcial 70/75	100	100	400
TPP060180	6 x 180	60,566	PZ3	Parcial 70/75	100	100	300
TPP060200	6 x 200	78,851	PZ3	Parcial 70/75	100	100	300
TPP060220	6 x 220	115,093	PZ3	Parcial 70/75	100	100	300

• Medidas sin homologar



Tirafondos de cabeza avellanada

TP

Blíster

CÓDIGO	MEDIDA	€/BOLSA	PCS B	BOLSAS
BZTPPO25016	2,5 x 16	2,024	40	20
BZTPPO25020	2,5 x 20	2,024	40	20
BZTPPO25025	2,5 x 25	2,024	40	20
BZTPPO30016	3 x 16	2,024	40	20
BZTPPO30020	3 x 20	2,024	40	20
BZTPPO30025	3 x 25	2,024	40	20
BZTPPO30030	3 x 30	2,024	40	20
BZTPPO35016	3,5 x 16	2,024	40	20
BZTPPO35020	3,5 x 20	2,024	40	20
BZTPPO35025	3,5 x 25	2,024	40	20
BZTPPO35030	3,5 x 30	2,024	40	20
BZTPPO35035	3,5 x 35	2,024	20	20
BZTPPO35040	3,5 x 40	2,024	20	20
BZTPPO35050	3,5 x 50	2,024	20	20
BZTPPO40016	4 x 16	2,024	40	20
BZTPPO40020	4 x 20	2,024	40	20
BZTPPO40025	4 x 25	2,024	40	20
BZTPPO40030	4 x 30	2,024	20	20
BZTPPO40035	4 x 35	2,024	20	20
BZTPPO40040	4 x 40	2,024	20	20
BZTPPO40045	4 x 45	2,024	20	20
BZTPPO40050	4 x 50	2,024	10	20
BZTPPO40060	4 x 60	2,024	10	20
BZTPPO45030	4,5 x 30	2,024	20	20
BZTPPO45035	4,5 x 35	2,024	20	20
BZTPPO45040	4,5 x 40	2,024	20	20
BZTPPO45045	4,5 x 45	2,024	10	20
BZTPPO45050	4,5 x 50	2,024	10	20
BZTPPO45060	4,5 x 60	2,024	10	20
BZTPPO45070	4,5 x 70	2,024	10	20
BZTPPO50030	5 x 30	2,024	10	20
BZTPPO50035	5 x 35	2,024	10	20
BZTPPO50040	5 x 40	2,024	10	20
BZTPPO50050	5 x 50	2,024	10	20
BZTPPO50060	5 x 60	2,024	10	20
BZTPPO50070	5 x 70	2,024	4	20
BZTPPO50080	5 x 80	2,024	4	20
BZTPPO50100	5 x 100	2,024	4	20
BZTPPO60040	6 x 40	2,024	10	20
BZTPPO60050	6 x 50	2,024	10	20
BZTPPO60060	6 x 60	2,024	10	20
BZTPPO60070	6 x 70	2,024	4	20
BZTPPO60080	6 x 80	2,024	4	20
BZTPPO60090	6 x 90	2,024	4	20
BZTPPO60100	6 x 100	2,024	4	20

Caja ventana

CÓDIGO	MEDIDA	€/CAJA	PCS C	CAJAS
VTPPO30016	3 x 16	4,287	250	8
VTPPO30020	3 x 20	4,787	250	8
VTPPO30025	3 x 25	5,217	250	8
VTPPO30030	3 x 30	5,645	250	8
VTPPO30040	3 x 40	7,313	250	8
VTPPO35016	3,5 x 16	4,610	250	8
VTPPO35020	3,5 x 20	5,353	250	8
VTPPO35025	3,5 x 25	6,103	250	8
VTPPO35030	3,5 x 30	6,543	250	8
VTPPO35035	3,5 x 35	5,186	150	8
VTPPO35040	3,5 x 40	5,387	150	8
VTPPO35050	3,5 x 50	4,866	100	8
VTPPO40016	4 x 16	5,801	250	8
VTPPO40020	4 x 20	6,641	250	8
VTPPO40025	4 x 25	7,340	250	8
VTPPO40030	4 x 30	6,004	175	8
VTPPO40035	4 x 35	5,807	150	8
VTPPO40040	4 x 40	6,250	150	8
VTPPO40045	4 x 45	7,631	150	8
VTPPO40050	4 x 50	5,742	100	8
VTPPO40060	4 x 60	6,699	100	8
VTPPO45030	4,5 x 30	6,719	150	8
VTPPO45035	4,5 x 35	7,362	150	8
VTPPO45040	4,5 x 40	7,918	150	8
VTPPO45045	4,5 x 45	5,985	90	8
VTPPO45050	4,5 x 50	7,142	100	8
VTPPO45060	4,5 x 60	6,680	80	8
VTPPO45070	4,5 x 70	6,050	60	8
VTPPO50030	5 x 30	5,629	100	8
VTPPO50035	5 x 35	6,127	100	8
VTPPO50040	5 x 40	6,719	100	8
VTPPO50050	5 x 50	8,048	100	8
VTPPO50060	5 x 60	7,980	80	8
VTPPO50070	5 x 70	4,527	35	8
VTPPO50080	5 x 80	4,423	30	8
VTPPO50090	5 x 90	4,949	30	8
VTPPO60040	6 x 40	9,972	100	8
VTPPO60050	6 x 50	8,927	80	8
VTPPO60060	6 x 60	7,951	60	8
VTPPO60070	6 x 70	5,158	30	8
VTPPO60080	6 x 80	5,727	30	8

TP-PO B

Bicromatado. Huella PZ



TP-PO Z

Cincado. Huella PZ



Disponible en varios recubrimientos. Consulte precio y plazo de entrega.

CÓDIGO	MEDIDA	€/100		LONGITUD DE LA ROSCA	UD. MIN. VENTA		
• TPPOZ25010	2,5 x 10	1,228	PZ1	Total	2.000	1.000	45.000
• TPPOZ25012	2,5 x 12	1,235	PZ1	Total	2.000	1.000	45.000
• TPPOZ25016	2,5 x 16	1,385	PZ1	Total	2.000	1.000	45.000
TPPOZ25020	2,5 x 20	1,550	PZ1	Total	2.000	1.000	24.000
TPPOZ25025	2,5 x 25	1,693	PZ1	Total	2.000	1.000	24.000
• TPPOZ30012	3 x 12	1,098	PZ1	Total	2.000	1.000	45.000
• TPPOZ30016	3 x 16	1,280	PZ1	Total	2.000	1.000	24.000
• TPPOZ30020	3 x 20	1,440	PZ1	Total	2.000	1.000	24.000
TPPOZ30025	3 x 25	1,673	PZ1	Total	2.000	1.000	12.000
TPPOZ30030	3 x 30	1,803	PZ1	Total	2.000	1.000	12.000
TPPOZ30040	3 x 40	2,447	PZ1	Total	2.000	1.000	6.000
• TPPOZ35016	3,5 x 16	1,410	PZ2	Total	2.000	1.000	24.000
• TPPOZ35020	3,5 x 20	1,709	PZ2	Total	2.000	1.000	12.000
TPPOZ35025	3,5 x 25	1,930	PZ2	Total	2.000	1.000	12.000
TPPOZ35030	3,5 x 30	2,165	PZ2	Total	2.000	1.000	12.000
TPPOZ35035	3,5 x 35	2,653	PZ2	Total	1.000	500	6.000
TPPOZ35040	3,5 x 40	2,883	PZ2	Total	1.000	500	6.000
TPPOZ35050	3,5 x 50	3,773	PZ2	Total	500	250	3.000
• TPPOZ40016	4 x 16	1,818	PZ2	Total	2.000	1.000	16.000
• TPPOZ40020	4 x 20	2,160	PZ2	Total	2.000	1.000	12.000
• TPPOZ40025	4 x 25	2,410	PZ2	Total	2.000	1.000	12.000
TPPOZ40030	4 x 30	2,863	PZ2	Total	1.000	500	6.000
TPPOZ40035	4 x 35	3,231	PZ2	Total	1.000	500	6.000
TPPOZ40040	4 x 40	3,376	PZ2	Total	1.000	500	6.000
TPPOZ40045	4 x 45	4,256	PZ2	Total	1.000	500	3.000
TPPOZ40050	4 x 50	4,700	PZ2	Total	500	250	3.000
TPPOZ40060	4 x 60	5,389	PZ2	Total	500	250	3.000
TPPOZ40070	4 x 70	6,640	PZ2	Parcial 52	500	250	1.500
• TPPOZ45020	4,5 x 20	2,730	PZ2	Total	1.000	500	12.000
• TPPOZ45025	4,5 x 25	3,240	PZ2	Total	1.000	500	6.000
• TPPOZ45030	4,5 x 30	3,635	PZ2	Total	1.000	500	6.000
TPPOZ45035	4,5 x 35	3,997	PZ2	Total	1.000	500	6.000
TPPOZ45040	4,5 x 40	4,410	PZ2	Total	1.000	500	3.000
TPPOZ45045	4,5 x 45	5,389	PZ2	Total	500	250	3.000
TPPOZ45050	4,5 x 50	5,800	PZ2	Total	500	250	3.000
TPPOZ45060	4,5 x 60	6,833	PZ2	Total	500	250	3.000
TPPOZ45070	4,5 x 70	8,353	PZ2	Parcial 52	500	250	1.500
TPPOZ45080	4,5 x 80	9,952	PZ2	Parcial 52	200	100	1.200
• TPPOZ50020	5 x 20	3,363	PZ2	Total	1.000	500	6.000
• TPPOZ50025	5 x 25	4,007	PZ2	Total	1.000	500	6.000
• TPPOZ50030	5 x 30	4,530	PZ2	Total	500	250	6.000
TPPOZ50035	5 x 35	5,113	PZ2	Total	500	250	3.000
TPPOZ50040	5 x 40	5,613	PZ2	Total	500	250	3.000
TPPOZ50045	5 x 45	6,250	PZ2	Total	500	250	3.000
TPPOZ50050	5 x 50	6,847	PZ2	Total	500	250	3.000
TPPOZ50060	5 x 60	8,237	PZ2	Total	500	250	1.500
TPPOZ50070	5 x 70	10,300	PZ2	Parcial 52	200	100	1.200
TPPOZ50080	5 x 80	11,632	PZ2	Parcial 52	200	100	1.200
TPPOZ50090	5 x 90	13,960	PZ2	Parcial 60	200	100	1.200
TPPOZ50100	5 x 100	14,918	PZ2	Parcial 60	200	100	1.200
TPPOZ50120	5 x 120	21,927	PZ2	Parcial 75	200	100	1.200
• TPPOZ60040	6 x 40	8,490	PZ3	Total	500	250	3.000
TPPOZ60050	6 x 50	9,783	PZ3	Total	500	250	1.500
TPPOZ60060	6 x 60	11,390	PZ3	Total	500	250	1.500
TPPOZ60070	6 x 70	14,763	PZ3	Parcial 52	200	100	1.200
TPPOZ60080	6 x 80	16,753	PZ3	Parcial 52	200	100	1.200
TPPOZ60090	6 x 90	18,397	PZ3	Parcial 60	200	100	1.200
TPPOZ60100	6 x 100	21,697	PZ3	Parcial 60	100	100	1.200
TPPOZ60110	6 x 110	25,395	PZ3	Parcial 70	100	100	600

• Medidas sin homologar

TP-PO Z

Cincado. Huella PZ

 Caja ventana

CÓDIGO	MEDIDA	€/100	PCS	CAJAS
VTPOZ30025	3 x 25	5,217	250	8
VTPOZ30030	3 x 30	5,645	250	8
VTPOZ35016	2,5 x 16	4,610	250	8
VTPOZ35020	2,5 x 20	5,353	250	8
VTPOZ35025	2,5 x 25	6,103	250	8
VTPOZ35030	3,5 x 30	6,543	250	8
VTPOZ35035	3,5 x 35	5,186	150	8
VTPOZ35040	3,5 x 40	5,387	150	8
VTPOZ35050	3,5 x 50	4,866	100	8
VTPOZ40016	3 x 16	5,801	250	8
VTPOZ40020	3 x 20	6,641	250	8
VTPOZ40025	4 x 25	7,340	250	8
VTPOZ40030	4 x 30	6,004	175	8
VTPOZ40035	4 x 35	5,807	150	8
VTPOZ40040	4 x 40	6,250	150	8
VTPOZ40045	4 x 45	7,631	150	8
VTPOZ40050	4 x 50	5,742	100	8
VTPOZ40060	4 x 60	6,699	100	8
VTPOZ45030	4,5 x 30	6,719	150	8
VTPOZ45035	4,5 x 35	7,362	150	8
VTPOZ45040	4,5 x 40	7,918	150	8
VTPOZ45045	4,5 x 45	5,985	90	8
VTPOZ45050	4,5 x 50	7,142	100	8
VTPOZ45060	4,5 x 60	6,680	80	8
VTPOZ45070	4,5 x 70	6,050	60	8
VTPOZ50030	5 x 30	5,629	100	8
VTPOZ50035	5 x 35	6,127	100	8
VTPOZ50040	5 x 40	6,719	100	8
VTPOZ50050	5 x 50	8,048	100	8
VTPOZ50060	5 x 60	7,980	80	8
VTPOZ50070	5 x 70	4,527	35	8
VTPOZ50080	5 x 80	4,423	30	8
VTPOZ50090	5 x 90	4,949	30	8
VTPOZ60060	6 x 60	7,951	60	8
VTPOZ60070	6 x 70	5,158	30	8
VTPOZ60080	6 x 80	5,727	30	8



Disponible en varios recubrimientos. Consulte precio y plazo de entrega.

DIN-7981 H

Tornillo rosca chapa con cabeza alomada

DIN-7981 HP Z

Cincado. Huella PH



Disponible en diferentes colores



Disponible en varios recubrimientos. Consulte precio y plazo de entrega.

CÓDIGO	MEDIDA	€/100				CÓDIGO	MEDIDA	€/100			
T8129006	2,9 x 6,5	1,663	PH1	1.000	45.000	T8148025	4,8 x 25	5,877	PH2	250	6.000
T8129009	2,9 x 9,5	1,720	PH1	1.000	30.000	T8148032	4,8 x 32	6,600	PH2	250	4.000
T8129013	2,9 x 13	1,733	PH1	1.000	24.000	T8148038	4,8 x 38	7,873	PH2	250	3.000
T8129016	2,9 x 16	1,940	PH1	1.000	24.000	T8148045	4,8 x 45	8,760	PH2	250	3.000
T8129019	2,9 x 19	2,103	PH1	1.000	24.000	T8148050	4,8 x 50	9,533	PH2	250	3.000
T8129022	2,9 x 22	2,410	PH1	1.000	12.000	T8148060	4,8 x 60	12,010	PH2	250	1.500
T8129025	2,9 x 25	2,713	PH1	500	12.000	T8148070	4,8 x 70	14,273	PH2	100	1.200
T8135006	3,5 x 6,5	1,733	PH2	1.000	24.000	T8148080	4,8 x 80	17,523	PH2	100	1.200
T8135009	3,5 x 9,5	1,780	PH2	1.000	24.000	T8148090	4,8 x 90	20,303	PH2	100	1.200
T8135013	3,5 x 13	2,117	PH2	500	15.000	T8148100	4,8 x 100	22,087	PH2	100	1.200
T8135016	3,5 x 16	2,457	PH2	500	12.000	T8148110	4,8 x 110	27,713	PH2	100	1.200
T8135019	3,5 x 19	2,673	PH2	500	12.000	T8148120	4,8 x 120	32,720	PH2	100	1.200
T8135025	3,5 x 25	3,377	PH2	250	6.000	T8155013	5,5 x 13	5,747	PH3	250	6.000
T8135032	3,5 x 32	4,207	PH2	250	6.000	T8155016	5,5 x 16	6,253	PH3	250	6.000
T8139009	3,9 x 9,5	2,137	PH2	500	15.000	T8155019	5,5 x 19	6,720	PH3	250	6.000
T8139013	3,9 x 13	2,590	PH2	500	12.000	T8155022	5,5 x 22	7,787	PH3	250	4.000
T8139016	3,9 x 16	2,763	PH2	500	12.000	T8155025	5,5 x 25	7,680	PH3	250	4.000
T8139019	3,9 x 19	3,220	PH2	500	12.000	T8155032	5,5 x 32	8,993	PH3	250	3.000
T8139022	3,9 x 22	3,587	PH2	250	6.000	T8155038	5,5 x 38	10,047	PH3	250	3.000
T8139025	3,9 x 25	3,973	PH2	250	6.000	T8155045	5,5 x 45	11,497	PH3	250	3.000
T8139032	3,9 x 32	4,487	PH2	250	6.000	T8155050	5,5 x 50	12,563	PH3	250	1.500
T8139038	3,9 x 38	5,250	PH2	250	6.000	T8155060	5,5 x 60	15,610	PH3	100	1.200
T8139045	3,9 x 45	6,213	PH2	250	3.000	T8155070	5,5 x 70	17,330	PH3	100	1.200
T8139050	3,9 x 50	6,897	PH2	250	3.000	T8155080	5,5 x 80	21,610	PH3	100	1.200
T8142009	4,2 x 9,5	2,637	PH2	500	12.000	T8155090	5,5 x 90	24,837	PH3	100	1.200
T8142013	4,2 x 13	2,843	PH2	500	12.000	T8155100	5,5 x 100	29,023	PH3	100	1.200
T8142016	4,2 x 16	3,413	PH2	500	12.000	T8155110	5,5 x 110	35,153	PH3	100	1.200
T8142019	4,2 x 19	3,517	PH2	500	8.000	T8155120	5,5 x 120	42,003	PH3	100	1.200
T8142022	4,2 x 22	4,483	PH2	250	6.000	T8163016	6,3 x 16	8,340	PH3	250	4.000
T8142025	4,2 x 25	4,383	PH2	250	6.000	T8163019	6,3 x 19	9,123	PH3	250	3.000
T8142032	4,2 x 32	5,130	PH2	250	6.000	T8163022	6,3 x 22	9,357	PH3	250	3.000
T8142038	4,2 x 38	6,003	PH2	250	3.000	T8163025	6,3 x 25	10,160	PH3	250	3.000
T8142045	4,2 x 45	6,750	PH2	250	3.000	T8163032	6,3 x 32	12,487	PH3	250	3.000
T8142050	4,2 x 50	7,267	PH2	250	3.000	T8163038	6,3 x 38	14,120	PH3	250	1.500
T8142060	4,2 x 60	9,620	PH2	250	3.000	T8163045	6,3 x 45	16,527	PH3	250	1.500
T8142070	4,2 x 70	10,807	PH2	250	1.500	T8163050	6,3 x 50	18,050	PH3	250	1.500
T8142080	4,2 x 80	12,867	PH2	250	1.500	T8163060	6,3 x 60	20,847	PH3	100	1.200
T8142090	4,2 x 90	17,487	PH2	250	1.500	T8163070	6,3 x 70	23,713	PH3	100	1.200
T8148009	4,8 x 9,5	3,757	PH2	500	12.000	T8163080	6,3 x 80	29,333	PH3	100	1.200
T8148013	4,8 x 13	3,900	PH2	500	8.000	T8163090	6,3 x 90	37,573	PH3	50	600
T8148016	4,8 x 16	4,367	PH2	250	6.000	T8163100	6,3 x 100	41,480	PH3	50	600
T8148019	4,8 x 19	5,120	PH2	250	6.000	T8163110	6,3 x 110	45,497	PH3	50	600
T8148022	4,8 x 22	5,597	PH2	250	6.000	T8163120	6,3 x 120	48,810	PH3	50	600

Blíster

CÓDIGO	MEDIDA	€/BOLSA	PCS	BOLSAS
BZT8135013	3,5 x 13	2,024	20	20
BZT8135016	3,5 x 16	2,024	20	20
BZT8135019	3,5 x 19	2,024	20	20
BZT8135009	3,5 x 9,5	2,024	40	20
BZT8139013	2,9 x 13	2,024	20	20
BZT8139016	2,9 x 16	2,024	20	20
BZT8139019	2,9 x 19	2,024	20	20
BZT8139025	2,9 x 25	2,024	10	20
BZT8139032	3,9 x 32	2,024	10	20
BZT8142013	4,2 x 13	2,024	20	20
BZT8142016	4,2 x 16	2,024	20	20
BZT8142019	4,2 x 19	2,024	20	20
BZT8142025	4,2 x 25	2,024	10	20
BZT8142032	4,2 x 32	2,024	10	20
BZT8142038	4,2 x 38	2,024	10	20
BZT8142009	4,2 x 9,5	2,024	20	20
BZT8148016	4,8 x 16	2,024	10	20
BZT8148019	4,8 x 19	2,024	10	20
BZT8148025	4,8 x 25	2,024	10	20
BZT8148032	4,8 x 32	2,024	10	20
BZT8148038	4,8 x 38	2,024	10	20
BZT8148050	4,8 x 50	2,024	10	20
BZT8148060	4,8 x 60	2,024	10	20
BZT8155025	3,5 x 25	2,024	10	20
BZT8155032	3,5 x 32	2,024	10	20
BZT8155038	5,5 x 38	2,024	10	20
BZT8155050	5,5 x 50	2,024	10	20

Caja ventana

CÓDIGO	MEDIDA	€/CAJA	PCS	CAJAS
VT8135009	3,5 x 9,5	6,121	250	8
VT8135013	3,5 x 13	6,124	200	8
VT8135016	3,5 x 16	6,748	200	8
VT8135019	3,5 x 19	7,346	200	8
VT8135025	3,5 x 25	9,580	200	8
VT8139009	2,9 x 9,5	6,350	200	8
VT8139013	2,9 x 13	7,100	200	8
VT8139016	2,9 x 16	7,815	200	8
VT8139019	2,9 x 19	6,861	150	8
VT8139022	2,9 x 22	5,448	100	8
VT8139025	2,9 x 25	5,704	100	8
VT8142009	4,2 x 9,5	7,650	200	8
VT8142013	4,2 x 13	7,779	200	8
VT8142016	4,2 x 16	9,273	200	8
VT8142019	4,2 x 19	7,366	150	8
VT8142022	4,2 x 22	6,095	100	8
VT8142025	4,2 x 25	5,891	100	8
VT8142032	4,2 x 32	6,952	100	8
VT8142038	4,2 x 38	6,140	75	8
VT8142050	4,2 x 50	5,390	50	8
VT8148009	4,8 x 9,5	7,492	150	8
VT8148013	4,8 x 13	7,805	150	8
VT8148016	4,8 x 16	5,865	100	8
VT8148019	4,8 x 19	6,664	100	8
VT8148025	4,8 x 25	7,918	100	8
VT8148032	4,8 x 32	8,691	100	8
VT8148038	4,8 x 38	10,987	100	8
VT8148045	4,8 x 45	8,843	70	8
VT8148050	4,8 x 50	6,771	50	8
VT8148060	4,8 x 60	8,526	50	8
VT8148070	4,8 x 70	8,116	40	8
VT8148080	4,8 x 80	6,486	25	8
VT8155019	3,5 x 19	9,005	100	8
VT8155025	3,5 x 25	9,661	90	8
VT8155032	3,5 x 32	12,400	100	8
VT8155038	5,5 x 38	10,615	75	8

Tornillo con rosca para madera y aglomerado. Cabeza hexagonal



DIN-571



MADERA



DIN-571

Cincado

CÓDIGO	MEDIDA	€/100			
• TB05030	5 x 30	5,690	8	200	4.800
• TB05040	5 x 40	7,533	8	200	2.400
TB05050	5 x 50	8,490	8	200	2.400
TB05060	5 x 60	9,587	8	200	2.400
• TB06025	6 x 25	6,714	10	200	2.400
• TB06030	6 x 30	7,140	10	200	2.400
• TB06035	6 x 35	8,183	10	200	2.400
• TB06040	6 x 40	8,797	10	200	2.400
• TB06045	6 x 45	9,533	10	200	2.400
• TB06050	6 x 50	10,527	10	200	2.400
TB06060	6 x 60	12,410	10	200	1.200
TB06070	6 x 70	14,280	10	200	1.200
TB06080	6 x 80	16,323	10	200	1.200
TB06090	6 x 90	18,828	10	100	1.200
TB06100	6 x 100	20,150	10	100	1.200
TB06110	6 x 110	25,447	10	100	1.200
TB06120	6 x 120	25,520	10	100	800
TB07030	7 x 30	11,844	12	200	2.400
TB07040	7 x 40	14,438	12	200	1.600
TB07050	7 x 50	16,410	12	200	1.200
TB07060	7 x 60	19,137	12	100	1.200
TB07070	7 x 70	22,618	12	100	1.200
TB07080	7 x 80	23,910	12	100	800
TB07090	7 x 90	24,315	12	100	400
TB07100	7 x 100	27,489	12	100	600
TB07120	7 x 120	33,611	12	100	600
• TB08030	8 x 30	13,720	13	200	1.200
• TB08040	8 x 40	17,307	13	200	1.200
• TB08045	8 x 45	17,421	13	200	1.200
• TB08050	8 x 50	18,697	13	200	1.200
• TB08060	8 x 60	21,343	13	200	1.200
• TB08070	8 x 70	24,270	13	200	800
TB08080	8 x 80	27,083	13	200	800
TB08090	8 x 90	31,720	13	100	600
TB08100	8 x 100	34,300	13	100	600
TB08110	8 x 110	36,861	13	100	600
TB08120	8 x 120	38,650	13	100	600
TB08130	8 x 130	44,506	13	100	400

CÓDIGO	MEDIDA	€/100			
TB08140	8 x 140	47,229	13	100	400
TB08150	8 x 150	49,734	13	100	400
TB08160	8 x 160	51,924	13	100	400
TB08180	8 x 180	66,859	13	100	300
TB08200	8 x 200	71,712	13	100	300
• TB10040	10 x 40	31,760	17	100	600
• TB10050	10 x 50	33,040	17	100	600
• TB10060	10 x 60	36,033	17	100	600
• TB10070	10 x 70	42,480	17	100	600
• TB10080	10 x 80	45,757	17	100	400
• TB10090	10 x 90	55,322	17	100	400
TB10100	10 x 100	55,013	17	100	400
TB10110	10 x 110	60,193	17	50	300
TB10120	10 x 120	66,353	17	50	300
TB10130	10 x 130	72,941	17	50	300
TB10140	10 x 140	83,433	17	50	200
TB10150	10 x 150	89,280	17	50	200
TB10160	10 x 160	95,303	17	50	200
TB10180	10 x 180	106,724	17	50	150
TB10200	10 x 200	114,900	17	50	150
• TB12060	12 x 60	58,960	19	50	300
• TB12070	12 x 70	64,877	19	50	300
• TB12080	12 x 80	70,727	19	50	300
• TB12090	12 x 90	75,370	19	50	300
• TB12100	12 x 100	83,787	19	50	300
TB12120	12 x 120	101,860	19	50	200
TB12130	12 x 130	109,417	19	50	100
TB12140	12 x 140	117,730	19	50	100
TB12150	12 x 150	121,913	19	50	200
TB12160	12 x 160	130,270	19	50	200
TB12180	12 x 180	156,133	19	50	150
TB12200	12 x 200	177,827	19	50	150
TB12220	12 x 220	193,983	19	50	100
TB12240	12 x 240	208,053	19	50	100
TB12260	12 x 260	228,083	19	50	100
• TB14100	14 x 100	149,793	22	50	200



Disponible en varios recubrimientos. Consulte precio y plazo de entrega.

• Medidas sin homologar

 Blíster

CÓDIGO	MEDIDA	€/BOLSA	PCS	BOLSAS
BZTB05030	5 x 30	2,024	4	20
BZTB05040	5 x 40	2,024	4	20
BZTB05050	5 x 50	2,024	4	20
BZTB06030	6 x 30	2,024	4	20
BZTB06040	6 x 40	2,024	4	20
BZTB06050	6 x 50	2,024	4	20
BZTB06060	6 x 60	2,024	4	20
BZTB06070	6 x 70	2,024	4	20
BZTB06080	6 x 80	2,024	4	20
BZTB07050	7 x 50	2,024	4	20
BZTB07060	7 x 60	2,024	4	20
BZTB07070	7 x 70	2,024	4	20
BZTB08040	8 x 40	2,024	4	20
BZTB08050	8 x 50	2,024	4	20
BZTB08060	8 x 60	2,024	4	20
BZTB08070	8 x 70	2,024	4	20
BZTB08080	8 x 80	2,024	4	15
BZTB08090	8 x 90	2,024	2	15
BZTB08100	8 x 100	2,024	2	15
BZTB10050	10 x 50	2,024	2	15
BZTB10060	10 x 60	2,024	2	15
BZTB10080	10 x 80	2,024	2	15

 Caja ventana

CÓDIGO	MEDIDA	€/CAJA	PCS	CAJAS
VTB05040	5 x 40	4,690	50	8
VTB05050	5 x 50	5,513	50	8
VTB06040	6 x 40	5,655	50	8
VTB06050	6 x 50	5,305	40	8
VTB06060	6 x 60	4,646	30	8
VTB07050	7 x 50	5,088	25	8
VTB07060	7 x 60	4,842	20	8
VTB07070	7 x 70	5,690	20	8
VTB07080	7 x 80	5,883	20	8
VTB08050	8 x 50	4,756	20	8
VTB08060	8 x 60	5,434	20	8
VTB08070	8 x 70	6,173	20	8
VTB08080	8 x 80	5,167	15	8
VTB08090	8 x 90	4,325	10	8
VTB08100	8 x 100	4,373	10	8
VTB10070	10 x 70	5,321	10	8
VTB10080	10 x 80	5,643	10	8
VTB10090	10 x 90	6,541	10	8
VTB10100	10 x 100	6,888	10	8

DIN-571

Tornillo con rosca para madera y aglomerado. Cabeza hexagonal

DIN-571 A2

Inoxidable A2

INOXIDABLE



CÓDIGO	MEDIDA	€/100			
• TBA206040	6 x 40	34,416	10	100	2.400
• TBA206050	6 x 50	41,827	10	100	1.200
TBA206060	6 x 60	50,067	10	100	1.200
TBA206070	6 x 70	53,770	10	100	1.200
• TBA208050	8 x 50	78,010	13	100	1.200
• TBA208060	8 x 60	89,494	13	100	1.200
• TBA208070	8 x 70	103,283	13	100	600
TBA208080	8 x 80	110,617	13	100	600
• TBA210080	10 x 80	193,453	17	100	400

• Medidas sin homologar

571 TR

Con rosca completa

MADERA



CÓDIGO	MEDIDA	€/100			
TBR06050	6 x 50	10,400	10	200	1.200
TBR06060	6 x 60	12,253	10	200	1.200
TBR06070	6 x 70	14,097	10	200	1.200
TBR08050	8 x 50	18,453	13	200	1.200
TBR08060	8 x 60	21,070	13	200	800
TBR08070	8 x 70	25,283	13	200	800
TBR08080	8 x 80	26,730	13	200	800
TBR10060	10 x 60	35,563	17	100	600
TBR10080	10 x 80	47,166	17	100	400

Tornillo rosca métrica con cabeza hexagonal 8.8. Rosca completa



DIN-933



METAL



DIN-933

Cincado

CÓDIGO	MEDIDA	€/100			
D93304008	M4 x 8	4,177	7	500	22.500
D93304010	M4 x 10	4,353	7	500	22.500
D93304012	M4 x 12	4,720	7	500	12.000
D93304016	M4 x 16	5,037	7	500	12.000
D93304020	M4 x 20	5,840	7	500	12.000
D93304025	M4 x 25	6,733	7	500	6.000
D93304030	M4 x 30	7,697	7	500	6.000
D93304035	M4 x 35	8,083	7	250	6.000
D93304040	M4 x 40	10,373	7	250	3.000
D93304045	M4 x 45	11,600	7	250	3.000
D93304050	M4 x 50	12,450	7	250	3.000
D93304060	M4 x 60	18,156	7	250	3.000
D93305010	M5 x 10	5,500	8	500	12.000
D93305012	M5 x 12	5,807	8	500	12.000
D93305016	M5 x 16	6,314	8	500	6.000
D93305020	M5 x 20	7,043	8	500	6.000
D93305025	M5 x 25	7,207	8	500	6.000
D93305030	M5 x 30	8,673	8	500	6.000
D93305035	M5 x 35	9,637	8	250	3.000
D93305040	M5 x 40	10,397	8	250	3.000
D93305045	M5 x 45	11,437	8	250	3.000
D93305050	M5 x 50	12,147	8	250	3.000
D93305060	M5 x 60	16,747	8	250	1.500
D93305070	M5 x 70	21,477	8	250	3.000
D93306010	M6 x 10	7,050	10	250	6.000
D93306012	M6 x 12	7,387	10	250	6.000
D93306016	M6 x 16	7,927	10	250	6.000
D93306020	M6 x 20	9,107	10	250	3.000
D93306025	M6 x 25	10,007	10	250	3.000
D93306030	M6 x 30	11,527	10	250	3.000
D93306035	M6 x 35	13,007	10	250	3.000
D93306040	M6 x 40	15,253	10	250	3.000
D93306045	M6 x 45	16,810	10	250	1.500
D93306050	M6 x 50	18,337	10	250	1.500
D93306060	M6 x 60	20,373	10	100	1.200
D93306065	M6 x 65	21,530	10	100	600
D93306070	M6 x 70	23,600	10	100	1.200
D93308016	M8 x 16	17,567	13	200	2.400
D93308020	M8 x 20	18,407	13	200	1.600
D93308025	M8 x 25	22,127	13	200	1.600
D93308030	M8 x 30	23,403	13	200	1.200
D93308035	M8 x 35	25,620	13	200	1.200
D93308040	M8 x 40	25,053	13	200	1.200
D93308045	M8 x 45	27,230	13	200	1.200
D93308050	M8 x 50	30,597	13	200	800
D93308060	M8 x 60	35,693	13	200	800
D93308070	M8 x 70	43,793	13	200	800
D93308080	M8 x 80	55,540	13	100	600
D93308090	M8 x 90	62,867	13	100	600
D93308100	M8 x 100	69,120	13	100	400
D93308110	M8 x 110	90,185	13	100	400
D93308120	M8 x 120	90,746	13	100	400
D93310016	M10 x 16	30,683	17	200	1.200
D93310020	M10 x 20	33,403	17	200	1.200
D93310025	M10 x 25	39,543	17	200	1.200
D93310030	M10 x 30	41,640	17	200	800
D93310035	M10 x 35	44,317	17	200	1.200
D93310040	M10 x 40	48,340	17	200	800
D93310045	M10 x 45	49,770	17	200	800
D93310050	M10 x 50	55,749	17	200	800
D93310060	M10 x 60	67,007	17	100	600
D93310070	M10 x 70	68,227	17	100	400
D93310080	M10 x 80	81,167	17	100	400
D93310090	M10 x 90	102,030	17	50	300

CÓDIGO	MEDIDA	€/100			
D93310100	M10 x 100	112,237	17	50	300
D93312020	M12 x 20	48,207	19	100	1.200
D93312025	M12 x 25	53,043	19	100	600
D93312030	M12 x 30	58,088	19	100	600
D93312035	M12 x 35	60,487	19	100	600
D93312040	M12 x 40	69,195	19	100	600
D93312045	M12 x 45	77,147	19	100	600
D93312050	M12 x 50	79,597	19	100	400
D93312060	M12 x 60	89,437	19	100	400
D93312070	M12 x 70	104,143	19	100	400
D93312080	M12 x 80	122,423	19	50	300
D93312090	M12 x 90	142,547	19	50	300
D93312100	M12 x 100	155,600	19	25	300
D93312110	M12 x 110	177,033	19	25	300
D93312120	M12 x 120	201,560	19	25	300
D93314030	M14 x 30	97,937	22	50	400
D93314035	M14 x 35	110,970	22	50	300
D93314040	M14 x 40	118,757	22	50	300
D93314045	M14 x 45	125,717	22	50	300
D93314050	M14 x 50	134,940	22	50	300
D93314060	M14 x 60	148,270	22	50	300
D93314070	M14 x 70	176,203	22	50	300
D93314080	M14 x 80	191,817	22	25	150
D93314090	M14 x 90	197,697	22	25	150
D93314100	M14 x 100	200,220	22	25	150
D93314110	M14 x 110	232,423	22	25	150
D93314120	M14 x 120	269,973	22	25	150
D93316030	M16 x 30	120,807	24	50	300
D93316035	M16 x 35	137,050	24	50	300
D93316040	M16 x 40	141,297	24	50	300
D93316045	M16 x 45	162,277	24	50	300
D93316050	M16 x 50	162,763	24	50	300
D93316060	M16 x 60	181,810	24	50	200
D93316070	M16 x 70	224,823	24	25	150
D93316080	M16 x 80	231,893	24	25	150
D93316090	M16 x 90	246,657	24	25	150
D93316100	M16 x 100	267,180	24	25	150
D93316110	M16 x 110	276,933	24	25	150
D93316120	M16 x 120	386,130	24	25	150
D93318030	M18 x 30	203,663	27	25	150
D93318035	M18 x 35	219,467	27	25	300
D93318040	M18 x 40	238,583	27	25	300
D93318045	M18 x 45	248,080	27	25	300
D93318050	M18 x 50	258,047	27	25	150
D93318060	M18 x 60	287,731	27	25	150
D93318070	M18 x 70	318,976	27	25	150
D93318080	M18 x 80	343,264	27	25	150
D93318090	M18 x 90	434,470	27	25	150
D93318100	M18 x 100	438,957	27	25	150
D93318110	M18 x 110	482,535	27	25	100
D93318120	M18 x 120	595,134	27	25	100
D93320030	M20 x 30	216,703	30	25	150
D93320035	M20 x 35	230,140	30	25	150
D93320040	M20 x 40	282,800	30	25	150
D93320045	M20 x 45	264,440	30	25	150
D93320050	M20 x 50	282,273	30	25	150
D93320060	M20 x 60	325,090	30	25	150
D93320070	M20 x 70	378,710	30	25	100
D93320080	M20 x 80	415,563	30	10	120
D93320090	M20 x 90	475,557	30	10	60
D93320100	M20 x 100	549,502	30	10	60
D93320110	M20 x 110	718,020	30	10	60
D93320120	M20 x 120	749,367	30	10	60



Disponible en varios recubrimientos. Consulte precio y plazo de entrega.

DIN-933

Tornillo rosca métrica con cabeza hexagonal 8.8. Rosca completa

DIN-933 A2

INOXIDABLE



Inoxidable A2



CÓDIGO	MEDIDA	€/100				CÓDIGO	MEDIDA	€/100			
D933IM04010	M4 x 10	10,633	7	500	12.000	D933IM10040	M10 x 40	98,223	17	200	-
D933IM04016	M4 x 16	12,737	7	500	12.000	D933IM10050	M10 x 50	117,010	17	200	-
D933IM04020	M4 x 20	14,653	7	500	8.000	D933IM10060	M10 x 60	133,997	17	100	600
D933IM04025	M4 x 25	15,807	7	500	8.000	D933IM10070	M10 x 70	151,147	17	100	400
D933IM04030	M4 x 30	18,517	7	500	6.000	D933IM10080	M10 x 80	177,847	17	100	400
D933IM04035	M4 x 35	22,220	7	250	6.000	D933IM10090	M10 x 90	200,363	17	50	300
D933IM04040	M4 x 40	24,707	7	250	6.000	D933IM10100	M10 x 100	226,077	17	50	300
D933IM05010	M5 x 10	11,110	8	500	8.000	D933IM12020	M12 x 20	121,863	19	100	600
D933IM05016	M5 x 16	13,023	8	500	-	D933IM12030	M12 x 30	126,757	19	100	600
D933IM05020	M5 x 20	14,750	8	500	6.000	D933IM12040	M12 x 40	142,853	19	100	400
D933IM05025	M5 x 25	16,953	8	500	4.000	D933IM12050	M12 x 50	164,857	19	100	400
D933IM05030	M5 x 30	19,633	8	500	4.000	D933IM12060	M12 x 60	187,900	19	100	400
D933IM05035	M5 x 35	21,743	8	250	3.000	D933IM12070	M12 x 70	211,187	19	100	-
D933IM05040	M5 x 40	24,423	8	250	3.000	D933IM12080	M12 x 80	263,870	19	50	300
D933IM05050	M5 x 50	29,887	8	250	3.000	D933IM12090	M12 x 90	288,893	19	50	300
D933IM06010	M6 x 10	18,637	10	250	6.000	D933IM12100	M12 x 100	313,927	19	25	150
D933IM06016	M6 x 16	19,743	10	250	4.000	D933IM14030	M14 x 30	238,857	22	50	300
D933IM06020	M6 x 20	22,873	10	250	4.000	D933IM14040	M14 x 40	261,600	22	50	300
D933IM06025	M6 x 25	23,767	10	250	3.000	D933IM14050	M14 x 50	298,000	22	50	300
D933IM06030	M6 x 30	27,613	10	250	3.000	D933IM14060	M14 x 60	338,943	22	50	200
D933IM06035	M6 x 35	31,227	10	250	2.000	D933IM14070	M14 x 70	377,613	22	50	200
D933IM06040	M6 x 40	34,517	10	250	2.000	D933IM14080	M14 x 80	405,613	22	25	150
D933IM06050	M6 x 50	40,960	10	250	1.500	D933IM14100	M14 x 100	556,327	22	25	150
D933IM08016	M8 x 16	36,437	13	200	1.600	D933IM16030	M16 x 30	263,757	24	50	300
D933IM08020	M8 x 20	39,493	13	200	1.600	D933IM16040	M16 x 40	280,067	24	50	200
D933IM08025	M8 x 25	44,583	13	200	1.600	D933IM16050	M16 x 50	312,313	24	50	200
D933IM08030	M8 x 30	49,567	13	200	1.200	D933IM16060	M16 x 60	355,310	24	50	200
D933IM08035	M8 x 35	54,540	13	200	1.200	D933IM16070	M16 x 70	396,043	24	25	150
D933IM08040	M8 x 40	60,203	13	200	1.200	D933IM16080	M16 x 80	449,020	24	25	150
D933IM08050	M8 x 50	72,443	13	200	800	D933IM16090	M16 x 90	518,110	24	25	150
D933IM08060	M8 x 60	82,680	13	200	800	D933IM16100	M16 x 100	561,237	24	25	100
D933IM08070	M8 x 70	99,077	13	200	800	D933IM18030	M18 x 30	527,307	27	25	100
D933IM08080	M8 x 80	113,240	13	100	600	D933IM18040	M18 x 40	557,707	27	25	200
D933IM08090	M8 x 90	125,463	13	100	600	D933IM18050	M18 x 50	609,220	27	25	150
D933IM08100	M8 x 100	140,770	13	100	600	D933IM18060	M18 x 60	680,887	27	25	150
D933IM10020	M10 x 20	74,233	17	200	800	D933IM18070	M18 x 70	757,020	27	25	100
D933IM10025	M10 x 25	77,853	17	200	800	D933IM18080	M18 x 80	828,710	27	25	100
D933IM10030	M10 x 30	85,317	17	200	800	D933IM18090	M18 x 90	900,387	27	25	100
D933IM10035	M10 x 35	93,013	17	200	800	D933IM18100	M18 x 100	972,060	27	25	100

Blíster

CÓDIGO	MEDIDA	€/BOLSA	PCS	BOLSAS
BZ3I04010	M4 x 10	2,561	6	20
BZ3I04016	M4 x 16	2,561	6	20
BZ3I04020	M4 x 20	2,561	6	20
BZ3I04030	M4 x 30	2,561	6	20
BZ3I04040	M4 x 40	2,561	6	20
BZ3I05010	M5 x 10	2,561	6	20
BZ3I05016	M5 x 16	2,561	6	20
BZ3I05020	M5 x 20	2,561	6	20
BZ3I05030	M5 x 30	2,561	6	20
BZ3I05040	M5 x 40	2,561	6	20
BZ3I05050	M5 x 50	2,561	6	20
BZ3I06016	M6 x 16	2,561	6	20
BZ3I06020	M6 x 20	2,561	6	20
BZ3I06025	M6 x 25	2,561	6	20
BZ3I06030	M6 x 30	2,561	6	20
BZ3I06040	M6 x 40	2,561	6	20
BZ3I06050	M6 x 50	2,561	6	20
BZ3I08016	M8 x 16	2,561	4	20
BZ3I08020	M8 x 20	2,561	4	20
BZ3I08025	M8 x 25	2,561	4	20
BZ3I08030	M8 x 30	2,561	4	20
BZ3I08040	M8 x 40	2,561	4	20
BZ3I08050	M8 x 50	2,561	4	20
BZ3I08060	M8 x 60	2,561	4	20
BZ3I10020	M10 x 20	2,561	2	20
BZ3I10030	M10 x 30	2,561	2	20
BZ3I10040	M10 x 40	2,561	2	20

Caja ventana

CÓDIGO	MEDIDA	€/CAJA	PCS	CAJAS
VD933I04010	M4 x 10	5,477	40	8
VD933I04016	M4 x 16	6,560	40	8
VD933I04020	M4 x 20	7,273	40	8
VD933I04030	M4 x 30	6,993	30	8
VD933I04040	M4 x 40	7,663	25	8
VD933I05010	M5 x 10	5,723	40	8
VD933I05016	M5 x 16	6,710	40	8
VD933I05020	M5 x 20	7,597	40	8
VD933I05030	M5 x 30	5,057	20	8
VD933I05040	M5 x 40	6,290	20	8
VD933I05050	M5 x 50	4,040	10	8
VD933I06010	M6 x 10	7,203	30	8
VD933I06016	M6 x 16	7,343	30	8
VD933I06020	M6 x 20	8,510	30	8
VD933I06025	M6 x 25	7,367	25	8
VD933I06030	M6 x 30	8,563	25	8
VD933I06040	M6 x 40	6,670	15	8
VD933I06050	M6 x 50	5,273	10	8
VD933I08016	M8 x 16	9,387	20	8
VD933I08020	M8 x 20	10,170	20	8
VD933I08025	M8 x 25	11,483	20	8
VD933I08030	M8 x 30	9,577	15	8
VD933I08040	M8 x 40	7,753	10	8
VD933I08050	M8 x 50	9,327	10	8
VD933I08060	M8 x 60	10,647	10	8
VD933I10020	M10 x 20	9,560	10	8
VD933I10030	M10 x 30	10,987	10	8
VD933I10040	M10 x 40	12,650	10	8
VD933I10050	M10 x 50	15,067	10	8
VD933I10060	M10 x 60	17,257	10	8

Tuerca hexagonal

DIN-934

METAL



DIN-934



Cincada

CÓDIGO	MEDIDA	€/100	LLAVE DE INSTALACIÓN		
D93403	M3	1,440	5,5	500	22.500
D93404	M4	1,490	7	1.000	45.000
D93405	M5	1,933	8	500	12.000
D93406	M6	3,030	10	500	12.000
D93408	M8	5,417	13	250	6.000
D93410	M10	12,923	17	250	3.000
D93412	M12	19,353	19	250	1.500
D93414	M14	27,253	22	100	1.200
D93416	M16	40,537	24	100	600
D93418	M18	57,867	27	100	600
D93420	M20	67,427	30	50	600
D93422	M22	108,150	32	50	300
D93424	M24	151,720	36	25	300
D93427	M27	242,901	41	25	150
D93430	M30	322,551	46	25	150
D93433	M33	459,714	50	10	120
D93436	M36	526,130	55	10	60



Disponible en varios recubrimientos. Consulte precio y plazo de entrega.

 Blíster

CÓDIGO	MEDIDA	€/BOLSA	PCS 	BOLSAS 
BZ934ZM03	M3	2,024	40	20
BZ934ZM04	M4	2,024	40	20
BZ934ZM05	M5	2,024	40	20
BZ934ZM06	M6	2,024	20	20
BZ934ZM08	M8	2,024	10	20
BZ934ZM10	M10	2,024	10	15
BZ934ZM12	M12	2,024	6	15

 Caja ventana

CÓDIGO	MEDIDA	€/CAJA	PCS 	CAJAS 
VD93403	M3	3,327	150	8
VD93404	M4	3,327	150	8
VD93405	M5	2,894	100	8
VD93406	M6	4,142	100	8
VD93408	M8	3,813	50	8
VD93410	M10	5,312	30	8
VD93412	M12	5,594	20	8

INOXIDABLE



DIN-934 A2

Inoxidable A2

CÓDIGO	MEDIDA	€/100	LLAVE DE INSTALACIÓN		
D934IM04	M4	4,223	7	500	22.500
D934IM05	M5	4,883	8	500	12.000
D934IM06	M6	8,060	10	500	12.000
D934IM08	M8	16,347	13	250	4.000
D934IM10	M10	36,467	17	250	2.000
D934IM12	M12	53,467	19	250	1.500
D934IM14	M14	76,850	22	100	800
D934IM16	M16	107,843	24	100	600
D934IM18	M18	171,523	27	100	600
D934IM20	M20	225,217	30	50	400
D934IM22	M22	311,300	32	50	300
D934IM24	M24	404,683	36	25	200

 Blíster

CÓDIGO	MEDIDA	€/BOLSA	PCS 	BOLSAS 
BZ934IM04	M4	2,561	10	20
BZ934IM05	M5	2,561	8	20
BZ934IM06	M6	2,561	8	20
BZ934IM08	M8	2,561	6	20
BZ934IM10	M10	2,561	5	15

 Caja ventana

CÓDIGO	MEDIDA	€/CAJA	PCS 	CAJAS 
VD934IM04	M4	3,110	50	8
VD934IM05	M5	3,597	50	8
VD934IM06	M6	5,340	50	8
VD934IM08	M8	6,500	30	8
VD934IM10	M10	9,667	20	8

DIN-985

Tuerca autoblocante

DIN-985

Cincada

METAL



CÓDIGO	MEDIDA	€/100	LLAVE DE INSTALACIÓN		
DZ98503	M3	2,670	5,5	500	22.500
DZ98504	M4	2,793	7	500	12.000
DZ98505	M5	2,990	8	500	12.000
DZ98506	M6	4,167	10	500	12.000
DZ98508	M8	7,443	13	250	6.000
DZ98510	M10	16,480	17	250	2.000
DZ98512	M12	25,943	19	100	1.200
DZ98514	M14	41,447	22	100	1.200
DZ98516	M16	50,513	24	50	600
DZ98518	M18	83,580	27	50	600
DZ98520	M20	105,083	30	25	300
DZ98522	M22	170,627	32	25	300
DZ98524	M24	207,380	36	25	300
DZ98527	M27	410,577	41	15	180
DZ98530	M30	694,663	46	15	90



Disponible en varios recubrimientos. Consulte precio y plazo de entrega.

Blíster

CÓDIGO	MEDIDA	€/BOLSA	PCS	BOLSAS
BZZ98503	M3	2,024	20	20
BZZ98504	M4	2,024	20	20
BZZ98505	M5	2,024	20	20
BZZ98506	M6	2,024	10	20
BZZ98508	M8	2,024	5	20
BZZ98510	M10	2,024	5	15
BZZ98512	M12	2,024	3	15

Caja ventana

CÓDIGO	MEDIDA	€/CAJA	PCS	CAJAS
VDZ98503	M3	4,168	100	8
VDZ98504	M4	4,168	100	8
VDZ98505	M5	4,349	100	8
VDZ98506	M6	5,018	80	8
VDZ98508	M8	4,979	50	8
VDZ98510	M10	5,555	25	8
VDZ98512	M12	5,565	15	8

DIN-985 A2

Inoxidable A2

INOXIDABLE



CÓDIGO	MEDIDA	€/100	LLAVE DE INSTALACIÓN		
D985IM04	M4	7,577	7	500	22.500
D985IM05	M5	8,157	8	500	8.000
D985IM06	M6	11,527	10	500	8.000
D985IM08	M8	22,720	13	250	4.000
D985IM10	M10	48,387	17	250	2.000
D985IM12	M12	75,213	19	100	1.200
D985IM14	M14	134,457	22	100	800
D985IM16	M16	162,963	24	50	600
D985IM18	M18	372,943	27	50	400
D985IM20	M20	478,307	30	25	300
D985IM22	M22	1.082,607	32	25	300
D985IM24	M24	1.459,673	36	25	150

Blíster

CÓDIGO	MEDIDA	€/BOLSA	PCS	BOLSAS
BZ985IM04	M4	2,561	10	20
BZ985IM05	M5	2,561	8	20
BZ985IM06	M6	2,561	8	20
BZ985IM08	M8	2,561	6	20
BZ985IM10	M10	2,561	5	15

Caja ventana

CÓDIGO	MEDIDA	€/CAJA	PCS	CAJAS
VD985IM04	M4	5,017	50	8
VD985IM05	M5	5,407	50	8
VD985IM06	M6	7,637	50	8
VD985IM08	M8	9,033	30	8
VD985IM10	M10	12,827	20	8

Tuerca brida grafilada



DIN-6923

METAL



DIN-6923

Cincada

CÓDIGO	MEDIDA	€/100	LLAVE DE INSTALACIÓN		
D692304	M4	2,847	7	500	15.000
D692305	M5	3,513	8	500	12.000
D692306	M6	5,313	10	500	8.000
D692308	M8	10,347	13	250	3.000
D692310	M10	16,887	15	250	2.000
D692312	M12	26,787	18	250	1.000
D692314	M14	46,840	21	100	600
D692316	M16	58,870	24	100	400



Disponible en varios recubrimientos. Consulte precio y plazo de entrega.

METAL



DIN-6923 A2

Tuerca brida grafilada DIN-6923. Inoxidable A2

CÓDIGO	MEDIDA	€/100	LLAVE DE INSTALACIÓN		
D6923IM08	M8	24,660	13	250	3.000
D6923IM10	M10	47,753	15	250	3.000
D6923IM12	M12	70,740	18	250	1.500



DIN-125

Arandela plana

DIN-125

Cincada

METAL



Disponible en varios recubrimientos. Consulte precio y plazo de entrega.

CÓDIGO	MEDIDA	€/100		
D12503	M3	0,687	1.000	45.000
D12504	M4	0,867	1.000	45.000
D12505	M5	1,187	1.000	45.000
D12506	M6	1,837	500	22.500
D12508	M8	3,193	250	11.250
D12510	M10	5,857	250	6.000
D12512	M12	9,740	250	3.000
D12514	M14	12,773	200	2.400
D12516	M16	16,643	100	2.400
D12518	M18	20,380	100	2.400
D12520	M20	23,927	50	1.200
D12522	M22	40,833	50	1.200
D12524	M24	55,873	50	600
D12527	M27	76,000	50	600
D12530	M30	101,127	50	300
D12533	M33	163,613	50	300
D12536	M36	223,013	25	300

Blíster

CÓDIGO	MEDIDA	€/BOLSA	PCS	BOLSAS
BZ125ZM03	M3	2,024	40	20
BZ125ZM04	M4	2,024	40	20
BZ125ZM05	M5	2,024	40	20
BZ125ZM06	M6	2,024	20	20
BZ125ZM08	M8	2,024	10	20
BZ125ZM10	M10	2,024	10	20
BZ125ZM12	M12	2,024	6	20

Caja ventana

CÓDIGO	MEDIDA	€/CAJA	PCS	CAJAS
VD12503	M3	3,492	200	8
VD12504	M4	3,492	200	8
VD12505	M5	3,188	150	8
VD12506	M6	3,780	100	8
VD12508	M8	4,365	75	8
VD12510	M10	8,083	75	8
VD12512	M12	9,525	50	8

DIN-125 A2

Inoxidable A2

INOXIDABLE



CÓDIGO	MEDIDA	€/100		
D125IM04	M4	1,323	500	22.500
D125IM05	M5	1,750	500	22.500
D125IM06	M6	3,170	500	22.500
D125IM08	M8	5,437	250	11.250
D125IM10	M10	10,387	250	6.000
D125IM12	M12	20,693	250	3.000
D125IM14	M14	28,960	200	2.400
D125IM16	M16	31,977	100	2.400
D125IM18	M18	47,420	100	1.600
D125IM20	M20	50,357	50	1.200
D125IM22	M22	59,713	50	1.200
D125IM24	M24	104,480	50	600

Blíster

CÓDIGO	MEDIDA	€/BOLSA	PCS	BOLSAS
BZ125IM04	M4	2,561	10	20
BZ125IM05	M5	2,561	8	20
BZ125IM06	M6	2,561	8	20
BZ125IM08	M8	2,561	6	20
BZ125IM10	M10	2,561	5	20

Caja ventana

CÓDIGO	MEDIDA	€/CAJA	PCS	CAJAS
VD125IM04	M4	3,143	100	8
VD125IM05	M5	3,153	75	8
VD125IM06	M6	3,987	75	8
VD125IM08	M8	4,157	50	8
VD125IM10	M10	6,927	50	8

Arandela plana ancha



DIN-9021

METAL





DIN-9021

Cincada



CÓDIGO	MEDIDA	€/100		
D902103	M3	1,527	500	22.500
D902104	M4	1,543	500	12.000
D902105	M5	2,047	500	12.000
D902106	M6	3,460	500	12.000
D902108	M8	8,473	200	4.800
D902110	M10	15,343	100	2.400
D902112	M12	28,990	100	1.200
D902114	M14	40,500	100	800
D902116	M16	48,927	50	600
D902118	M18	89,773	50	600
D902120	M20	97,630	25	300
D902122	M22	188,513	25	300
D902124	M24	214,537	25	150



 Blíster

CÓDIGO	MEDIDA	€/BOLSA	PCS 	BOLSAS 
BZ902103	M3	2,024	20	20
BZ902104	M4	2,024	20	20
BZ902105	M5	2,024	20	20
BZ902106	M6	2,024	10	20
BZ902108	M8	2,024	5	20
BZ902110	M10	2,024	5	20
BZ902112	M12	2,024	4	20

 Caja ventana

CÓDIGO	MEDIDA	€/CAJA	PCS 	CAJAS 
VD902103	M3	3,537	125	8
VD902104	M4	3,537	125	8
VD902105	M5	4,110	125	8
VD902106	M6	4,960	100	8
VD902108	M8	5,413	50	8
VD902110	M10	5,683	30	8
VD902112	M12	5,390	15	8





Disponibile en varios recubrimientos. Consulte precio y plazo de entrega.

INOXIDABLE

DIN-9021 A2

Inoxidable A2

CÓDIGO	MEDIDA	€/100		
D9021IM04	M4	2,617	500	22.500
D9021IM05	M5	4,793	500	12.000
D9021IM06	M6	8,683	500	8.000
D9021IM08	M8	17,893	200	4.800
D9021IM10	M10	38,727	100	1.600
D9021IM12	M12	66,793	100	800
D9021IM14	M14	150,653	100	800
D9021IM16	M16	145,870	50	600
D9021IM18	M18	261,187	50	400
D9021IM20	M20	279,523	25	300
D9021IM22	M22	301,667	25	200
D9021IM24	M24	346,913	25	150



 Blíster

CÓDIGO	MEDIDA	€/BOLSA	PCS 	BOLSAS 
BZ9021IM04	M4	2,561	10	20
BZ9021IM05	M5	2,561	8	20
BZ9021IM06	M6	2,561	8	20
BZ9021IM08	M8	2,561	6	20
BZ9021IM10	M10	2,561	5	20

 Caja ventana

CÓDIGO	MEDIDA	€/CAJA	PCS 	CAJAS 
VD9021IM04	M4	3,860	100	8
VD9021IM05	M5	4,763	75	8
VD9021IM06	M6	8,473	75	8
VD9021IM08	M8	9,077	40	8
VD9021IM10	M10	10,267	20	8

PUN



Puntas de atornillar

PU-PH

METAL

PH



CÓDIGO	MEDIDA	€/100	LONGITUD			
PUPHC01	PH1	73,543	25	PH1	25	1.125
PUPHL01	PH1	117,973	50	PH1	25	1.125
PUPHC02	PH2	73,543	25	PH2	25	1.125
PUPHL02	PH2	117,973	50	PH2	25	1.125
PUPHC03	PH3	73,543	25	PH3	25	1.125
PUPHL03	PH3	117,973	50	PH3	25	1.125

 Blíster



CÓDIGO	MEDIDA	€/BOLSA	PCS 	BOLSAS 
BZPUPHCL01	PH1	3,350	4	20
BZPUPHCL02	PH2	3,350	4	20
BZPUPHCL03	PH3	3,350	4	20

PU-TO

METAL

TX



CÓDIGO	MEDIDA	€/100	LONGITUD			
PUT0010	T10	82,853	25	TX10	25	1.125
PUT0015	T15	82,853	25	TX15	25	1.125
PUT0020	T20	82,853	25	TX20	25	1.125
PUT0025	T25	82,853	25	TX25	25	1.125
PUT0030	T30	82,853	25	TX30	25	1.125
PUT0040	T40	82,853	25	TX40	25	1.125



 Blíster

CÓDIGO	MEDIDA	€/BOLSA	PCS 	BOLSAS 
BZPUTOT01	T10+T20	3,350	2	20
BZPUTOT02	T30+T40	3,350	2	20

METAL

PU-OX

OXBIT

CÓDIGO	MEDIDA	€/100	LONGITUD			
PUOXBITC10	OXB-10	103,570	25	OXB-10	25	1.125
PUOXBITL10	OXB-10	177,367	50	OXB-10	25	1.125
PUOXBITC15	OXB-15	103,570	25	OXB-15	25	1.125
PUOXBITL15	OXB-15	177,367	50	OXB-15	25	1.125
PUOXBITC20	OXB-20	103,570	25	OXB-20	25	1.125
PUOXBITL20	OXB-20	177,367	50	OXB-20	25	1.125
PUOXBITC25	OXB-25	103,570	25	OXB-25	25	1.125
PUOXBITL25	OXB-25	177,367	50	OXB-25	25	1.125
PUOXBITC30	OXB-30	103,570	25	OXB-30	25	1.125
PUOXBITL30	OXB-30	177,367	50	OXB-30	25	1.125
PUOXBITC40	OXB-40	103,570	25	OXB-40	25	1.125
PUOXBITL40	OXB-40	177,367	50	OXB-40	25	1.125



CARACTERÍSTICAS

Ajuste perfecto en tornillo:

Garantizan que el tornillo quede totalmente fijado en la punta, permitiendo una instalación ergonómica en cualquier posición y mejorando el guiado del tornillo.

Transmisión óptima de la fuerza:

Aseguran un asiento perfecto en la mortaja y aumentan la superficie de apriete, optimizando la transmisión del par de apriete.

Anti Cam-Out:

Las puntas OXBIT reducen el efecto "Cam-Out" que en el caso de trabajos con máquina son especialmente altas y pueden provocar un deslizamiento de la punta saliéndose de la mortaja del tornillo. Esto aumenta la vida útil de las puntas y de las mortajas.

Ideal para aplicaciones de altas prestaciones:

Especialmente diseñadas para garantizar la transmisión en trabajos con pares altos, soportan altas velocidades y el par de los atornilladores de impacto.

Menor esfuerzo:

Aumentan la transmisión del par de apriete, permitiendo la instalación con un menor esfuerzo, incluso con pares de apriete elevados.

Aumento de la vida útil de la punta:



Gracias al diseño de las puntas OXBIT y al ajuste perfecto con la mortaja, permiten alargar la vida útil de las puntas y de las mortajas.



METAL

PU-PO

PZ

CÓDIGO	MEDIDA	€/100	LONGITUD			
PUPOC01	PZ1	73,543	25	PZ1	25	1.125
PUPOL01	PZ1	117,973	50	PZ1	25	1.125
PUPOC02	PZ2	73,543	25	PZ2	25	1.125
PUPOL02	PZ2	117,973	50	PZ2	25	1.125
PUPOC03	PZ3	73,543	25	PZ3	25	1.125
PUPOL03	PZ3	117,973	50	PZ3	25	1.125





Blíster

CÓDIGO	MEDIDA	€/BOLSA	PCS 	BOLSAS 
BZPUPOCL01	PZ1	3,350	4	20
BZPUPOCL02	PZ2	3,350	4	20
BZPUPOCL03	PZ3	3,350	4	20

METAL

PU-CU

Cuadrada

CÓDIGO	MEDIDA	€/100	LONGITUD			
PUCUC01	PC1	73,543	25	PC1	25	1.125
PUCUL01	PC1	117,973	50	PC1	25	1.125
PUCUC02	PC2	73,543	25	PC2	25	1.125
PUCUL02	PC2	117,973	50	PC2	25	1.125
PUCUC03	PC3	73,543	25	PC3	25	1.125
PUCUL03	PC3	117,973	50	PC3	25	1.125





BOCA

Bocas hexagonales magnéticas

METAL



CÓDIGO	MEDIDA	€/100	LONGITUD	LLAVE DE INSTALACIÓN		
BOCA006	6 mm.	426,000	65	1/4"	5	225
BOCA007	7 mm.	426,000	65	1/4"	5	225
BOCA008	8 mm.	426,000	65	1/4"	5	225
BOCA010	10 mm.	426,000	65	1/4"	5	225
BOCA013	NEW 13 mm.	583,333	65	1/4"	5	225
BOCA055	NEW 5,5 mm.	426,000	65	1/4"	5	225

 Blíster



CÓDIGO	MEDIDA	€/BOLSA	PCS 	BOLSAS 
BZBOCA008	8 mm.	4,649	1	20
BZBOCA010	10 mm.	4,649	1	20

PU-PM

Porta puntas magnético 1/4

METAL



CÓDIGO	MEDIDA	€/100	LONGITUD		
PUPM014	1/4" x 60	540,410	65	5	225



**GAMA
INOX**



MTH

Anclaje macho para cargas altas en hormigón no fisurado

MTH-A4

Homologado ETE Opt.7. Eje Inoxidable A4. Clip Inoxidable A4



Disponible con arandela DIN 9021.
Consultar precio y plazo



Útil de colocación

02 Info Técnica
P. 284

INOXIDABLE



CÓDIGO	MEDIDA	€/100	ESPOSOR MÁX. A FIJAR	LETRA EJE (LONGITUD)		
• MIA406045	M6 x 45 Ø6	173,095	1	A	200	1.200
• MIA406060	M6 x 60 Ø6	188,579	2	B	200	1.200
• MIA406080	M6 x 80 Ø6	210,889	22	D	200	1.200
• MIA408050	M8 x 50 Ø8	219,092	4	A	100	800
MIA408075	M8 x 75 Ø8	232,662	5	C	100	600
MIA408090	M8 x 90 Ø8	259,624	20	E	100	600
MIA408115	M8 x 115 Ø8	341,065	45	G	100	400
MIA410070	M10 x 70 Ø10	381,043	3	C	100	400
MIA410090	M10 x 90 Ø10	431,894	10	E	100	400
MIA410120	M10 x 120 Ø10	525,007	40	G	50	300
MIA410150	M10 x 150 Ø10	768,840	70	I	50	200
• MIA412075	M12 x 75 Ø12	569,823	5	C	50	300
MIA412090	M12 x 90 Ø12	592,563	13	D	50	200
MIA412110	M12 x 110 Ø12	682,320	18	F	50	200
MIA412140	M12 x 140 Ø12	818,203	48	I	50	200
• MIA416090	M16 x 90 Ø16	1.479,897	4	D	25	150
MIA416145	M16 x 145 Ø16	1.827,627	23	I	25	100
MIA416170	M16 x 170 Ø16	2.110,490	48	K	25	75
• MIA420120	M20 x 120 Ø20	2.453,313	5	G	20	40
MIA420170	M20 x 170 Ø20	3.353,590	23	K	20	40
MIA420220	M20 x 220 Ø20	4.174,890	73	O	20	40

• Medidas sin homologar
• Medida sin homologar para fuego

Caja ventana

CÓDIGO	MEDIDA	€/CAJA	PCS	CAJAS
VMIA408075	M8 x 75 Ø8	31,286	10	8
VMIA410090	M10 x 90 Ø10	42,817	8	8
VMIA412110	M12 x 110 Ø12	48,987	6	8

Bolsa autoservicio

CÓDIGO	MEDIDA	€/BOLSA	PCS	BOLSAS
LSMIA408075	M8 x 75 Ø8	34,525	12	7
LSMIA410090	M10 x 90 Ø10	45,071	8	7
LSMIA412110	M12 x 110 Ø12	49,064	6	5

Anclaje macho para cargas altas en hormigón no fisurado

MTH



02 Info Técnica
P. 284

INOXIDABLE



MTH-A2

Homologado ETE Opt.7. Eje Inoxidable A2. Clip Inoxidable A2

CÓDIGO	MEDIDA	€/100	ESPESOR MÁX. A FIJAR	LETRA EJE (LONGITUD)		
• MI06045	M6 x 45 Ø6	158,190	1	A	200	1.200
• MI06060	M6 x 60 Ø6	177,403	2	B	200	1.200
• MI06080	M6 x 80 Ø6	185,553	22	D	200	1.200
• MI06120	M6 x 120 Ø6	229,172	62	G	100	600
• MI06140	M6 x 140 Ø6	290,054	82	I	100	600
• MI06160	M6 x 160 Ø6	314,630	102	J	100	400
• MI06170	M6 x 170 Ø6	331,287	112	K	100	400
• MI06180	M6 x 180 Ø6	383,183	122	L	100	300
• MI08050	M8 x 50 Ø8	188,427	4	A	100	800
MI08075	M8 x 75 Ø8	206,393	5	C	100	600
MI08090	M8 x 90 Ø8	234,873	20	E	100	600
MI08115	M8 x 115 Ø8	303,823	45	G	100	400
MI10070	M10 x 70 Ø10	319,347	3	C	100	400
MI10090	M10 x 90 Ø10	357,470	10	E	100	400
MI10120	M10 x 120 Ø10	418,990	40	G	50	300
MI10150	M10 x 150 Ø10	597,280	70	I	50	200
• MI12075	M12 x 75 Ø12	484,227	5	C	50	300
MI12090	M12 x 90 Ø12	485,333	13	D	50	200
MI12110	M12 x 110 Ø12	534,833	18	F	50	200
MI12140	M12 x 140 Ø12	670,347	48	I	50	200
• MI16090	M16 x 90 Ø16	1.262,968	4	D	25	150
MI16145	M16 x 145 Ø16	1.513,809	23	I	25	100
MI16170	M16 x 170 Ø16	1.659,910	48	K	25	75
• MI20120	M20 x 120 Ø20	2.008,703	5	G	20	40
MI20170	M20 x 170 Ø20	2.573,157	23	K	20	40
MI20220	M20 x 220 Ø20	3.157,720	73	O	20	40

• Medidas sin homologar
• Medida sin homologar para fuego



 Util de colocación

 Blíster

CÓDIGO	MEDIDA	€/BOLSA	PCS	BOLSAS
BZMI08075	M8 x 75 Ø8	4,649	2	12
BZMI10090	M10 x 90 Ø10	4,649	2	10

 Caja ventana

CÓDIGO	MEDIDA	€/CAJA	PCS	CAJAS
VMI08075	M8 x 75 Ø8	28,888	10	8
VMI08090	M8 x 90 Ø8	30,887	10	8
VMI10070	M10 x 70 Ø10	31,918	8	8
VMI10090	M10 x 90 Ø10	35,727	8	8
VMI10120	M10 x 120 Ø10	31,406	6	8
VMI12110	M12 x 110 Ø12	38,965	6	8

 Bolsa autoservicio

CÓDIGO	MEDIDA	€/BOLSA	PCS	BOLSAS
LSMI08075	M8 x 75 Ø8	29,317	12	7
LSMI08090	M8 x 90 Ø8	33,362	12	7
LSMI10070	M10 x 70 Ø10	35,911	10	6
LSMI10090	M10 x 90 Ø10	35,727	8	6
LSMI10120	M10 x 120 Ø10	37,689	8	6
LSMI12110	M12 x 110 Ø12	38,965	6	6

CH

Anclaje antigiro para cargas medias

CH-A2

Inoxidable A2. Homologado ETE Opt.7



02 Info. Técnica
P. 268

INOXIDABLE



CÓDIGO	MEDIDA	€/100		
ACHTA208C	M6 x 45 Ø8	114,150	100	1.200
• ACHTA209C	M6 x 45 Ø9	129,177	100	1.200
ACHTA208L	M6 x 60 Ø8	128,957	100	600
• ACHTA209L	M6 x 60 Ø9	149,200	100	600
ACHTA210C	M8 x 60 Ø10	184,947	100	600
• ACHTA211C	M8 x 60 Ø11	222,503	100	400
ACHTA210L	M8 x 80 Ø10	212,753	100	400
• ACHTA211L	M8 x 80 Ø11	262,103	100	400
ACHTA212C	M10 x 70 Ø12	311,993	100	200
• ACHTA214C	M10 x 70 Ø14	415,027	100	300
ACHTA212L	M10 x 100 Ø12	381,557	50	200
• ACHTA214L	M10 x 100 Ø14	462,917	50	200
ACHTA216C	M12 x 80 Ø16	615,203	50	100
ACHTA216L	M12 x 110 Ø16	778,480	50	100
ACHTA220C	M16 x 110 Ø20	1.598,263	25	75

• Medidas sin homologar

Blíster

CÓDIGO	MEDIDA	€/BOLSA	PCS	BOLSAS
BZACHTA208C	M6 x 45 Ø8	4,649	2	15
BZACHTA208L	M6 x 60 Ø8	4,649	2	15
BZACHTA210C	M8 x 60 Ø10	4,649	2	15
BZACHTA210L	M8 x 80 Ø10	4,649	2	15

Caja ventana

CÓDIGO	MEDIDA	€/CAJA	PCS	CAJAS
VACHTA208C	M6 x 45 Ø8	13,629	10	8
VACHTA208L	M6 x 60 Ø8	15,847	10	8
VACHTA210C	M8 x 60 Ø10	14,191	6	8
VACHTA210L	M8 x 80 Ø10	16,897	6	8
VACHTA212C	M10 x 70 Ø12	15,924	4	8
VACHTA212L	M10 x 100 Ø12	19,655	4	8

Bolsa autoservicio

CÓDIGO	MEDIDA	€/BOLSA	PCS	BOLSAS
LSACHTA208C	M6 x 45 Ø8	14,721	12	6
LSACHTA208L	M6 x 60 Ø8	17,114	12	6
LSACHTA210C	M8 x 60 Ø10	17,030	8	6
LSACHTA210L	M8 x 80 Ø10	20,276	8	6
LSACHTA212C	M10 x 70 Ø12	21,502	6	6
LSACHTA212L	M10 x 100 Ø12	19,655	4	5

CH-PI

Cabeza plana inoxidable A2.
Homologado ETE Opt.7



02 Info. Técnica
P. 265

INOXIDABLE

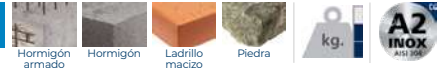

CÓDIGO	MEDIDA	€/100		
ACHTPI08C	M6 x 45 Ø8	118,747	4	1.200
ACHTPI08L	M6 x 60 Ø8	152,047	4	1.200
ACHTPI10C	M8 x 60 Ø10	224,017	5	600
ACHTPI10L	M8 x 80 Ø10	265,190	5	400
ACHTPI12C	M10 x 70 Ø12	354,223	6	300
ACHTPI12L	M10 x 100 Ø12	418,203	6	300

HE

Anclaje hembra con cono interior para grandes cargas

HE-A4

Inoxidable A4. Homologado ETE
Aplicaciones no estructurales



02 Info. Técnica
P. 276

INOXIDABLE



CÓDIGO	MEDIDA	€/100	LONGITUD		
HEA4M06	M6 x 25 Ø8	113,850	25	100	4.000
HEA4M08	M8 x 30 Ø10	162,337	30	100	1.600
HEA4M10	M10 x 40 Ø12	243,967	40	50	800
HEA4M12	M12 x 50 Ø15	485,740	50	50	600
HEA4M16	M16 x 65 Ø20	1.031,163	65	25	250
HEA4M20	M20 x 80 Ø25	1.784,273	80	25	100



Anclaje hembra con cono interior para grandes cargas

HE

02 Info
P. 277 Técnica

INOXIDABLE



CÓDIGO	MEDIDA	€/100	LONGITUD		
HEC4M06	M6 x 25 Ø8	149,077	25	100	3.200
HEC4M08	M8 x 30 Ø10	213,453	30	100	1.600
HEC4M10	M10 x 40 Ø12	329,780	40	50	800
HEC4M12	M12 x 50 Ø15	592,930	50	50	400

HE-C4

Con collarín. Inoxidable A4. Homologado ETE Aplicaciones no estructurales





Pletina de fijación

PF

INOXIDABLE



CÓDIGO	MEDIDA	€/100		
PFA4M0800	M8	303,137	100	600
PFA4M0810	M8 + M10	361,303	100	600
PFA4M1000	M10	346,320	100	600

PF-A4

Inoxidable A4







Espárragos con tuerca y arandela para anclaje químico

EQ

QUÍMICOS



CÓDIGO	MEDIDA	€/100			CÓDIGO	MEDIDA	€/100		
EQA208110	M8 x 110	280,257	10	240	EQA220260	M20 x 260	3.199,710	6	12
EQA210130	M10 x 130	487,530	10	120	EQA224300	M24 x 300	5.113,313	6	12
EQA212160	M12 x 160	807,990	10	120	EQA230330	M30 x 330	8.582,733	6	12
EQA216190	M16 x 190	1.674,133	10	40					





EQ-A2

Inoxidable A2



QUÍMICOS



CÓDIGO	MEDIDA	€/100			CÓDIGO	MEDIDA	€/100		
EQA408110	M8 x 110	338,743	10	240	EQA420260	M20 x 260	5.048,270	6	12
EQA410130	M10 x 130	615,293	10	120	EQA424300	M24 x 300	8.320,540	6	12
EQA412160	M12 x 160	1.058,413	10	120	EQA430330	M30 x 330	14.677,490	6	12
EQA416190	M16 x 190	2.073,420	10	40					

EQ-A4

Inoxidable A4



T-NUX

Taco de nylon universal de alto rendimiento

T-NUX A A4

Inoxidable A4. Cabeza avellanada.
Huella TX. Homologado ETE



02
P. 278
Info.
Técnica

INOXIDABLE



CÓDIGO	MEDIDA	€/100		ESPOSOR MÁX. A FIJAR		
• TNXA408080	8 x 80 Ø8	283,350	TX30	10	50	600
• TNXA408100	8 x 100 Ø8	341,673	TX30	30	50	600
• TNXA408120	8 x 120 Ø8	422,090	TX30	50	50	300
TNXA410080	10 x 80 Ø10	360,653	TX40	10	50	300
TNXA410100	10 x 100 Ø10	430,607	TX40	30	50	300
TNXA410120	10 x 120 Ø10	501,470	TX40	50	50	300
TNXA410140	10 x 140 Ø10	594,653	TX40	70	50	300

• Medida sin homologar para fuego

T-NUX E A4

Inoxidable A4. Cabeza hexagonal.
Huella TX. Homologado ETE



02
P. 278
Info.
Técnica

INOXIDABLE



CÓDIGO	MEDIDA	€/100	Nº HUELLA	ESPOSOR MÁX. A FIJAR		
• TNXE408080	8 x 80 Ø8	397,757	SW10/TX30	10	50	600
• TNXE408100	8 x 100 Ø8	471,447	SW10/TX30	30	50	300
TNXE410080	10 x 80 Ø10	527,587	SW13/TX40	10	50	300
TNXE410100	10 x 100 Ø10	550,990	SW13/TX40	30	50	300
TNXE410120	10 x 120 Ø10	662,293	SW13/TX40	50	50	300
TNXE410140	10 x 140 Ø10	772,567	SW13/TX40	70	50	200

• Medida sin homologar para fuego

DIN-7504-K

Tornillo autotaladrante de cabeza hexagonal

DIN-7504-K A2

Tornillo. Inoxidable A2



INOXIDABLE



CÓDIGO	MEDIDA	€/100			
ABEI4213	4,2 x 13	18,393	7	1.000	12.000
ABEI4216	4,2 x 16	20,637	7	1.000	8.000
ABEI4219	4,2 x 19	21,390	7	1.000	8.000
ABEI4813	4,8 x 13	26,023	8	1.000	8.000
ABEI4816	4,8 x 16	25,427	8	500	6.000
ABEI4819	4,8 x 19	27,513	8	500	6.000
ABEI4825	4,8 x 25	30,810	8	500	6.000
ABEI4832	4,8 x 32	36,633	8	500	3.000
ABEI5519	5,5 x 19	37,987	8	500	6.000
ABEI5522	5,5 x 22	40,527	8	500	4.000
ABEI5525	5,5 x 25	43,070	8	500	6.000
ABEI6319	6,3 x 19	57,573	10	500	3.000
ABEI6325	6,3 x 25	65,500	10	500	3.000

Arandela vulcanizada de acero-EPDM



ARVUL

INOXIDABLE



ARVUL A2

Inoxidable A2

CÓDIGO	MEDIDA	€/100	Ø INTERIOR ARANDELA		
ARINO14	P14	13,167	2.5	1.000	12.000
ARINO16	P16	14,887	2.7	1.000	6.000
ARINO18	P18	18,733	3.2	1.000	6.000
ARINO25	P25	34,640	3.3	500	3.000
ARINOM30	P30	54,033	6.3	500	1.500



Tornillo con rosca para madera y aglomerado. Cabeza hexagonal



DIN-571

INOXIDABLE



DIN-571 A2

Inoxidable A2

CÓDIGO	MEDIDA	€/100			
• TBA206040	6 x 40	34,416	10	100	2.400
• TBA206050	6 x 50	41,827	10	100	1.200
TBA206060	6 x 60	50,067	10	100	1.200
TBA206070	6 x 70	53,770	10	100	1.200
• TBA208050	8 x 50	78,010	13	100	1.200
• TBA208060	8 x 60	89,494	13	100	1.200
• TBA208070	8 x 70	103,283	13	100	600
TBA208080	8 x 80	110,617	13	100	600
• TBA210080	10 x 80	193,453	17	100	400



• Medidas sin homologar

DIN-933

Tornillo rosca métrica con cabeza hexagonal 8.8. Rosca completa

DIN-933 A2

INOXIDABLE



Inoxidable A2



CÓDIGO	MEDIDA	€/100				CÓDIGO	MEDIDA	€/100			
D933IM04010	M4 x 10	10,633	7	500	12.000	D933IM10040	M10 x 40	98,223	17	200	-
D933IM04016	M4 x 16	12,737	7	500	12.000	D933IM10050	M10 x 50	117,010	17	200	-
D933IM04020	M4 x 20	14,653	7	500	8.000	D933IM10060	M10 x 60	133,997	17	100	600
D933IM04025	M4 x 25	15,807	7	500	8.000	D933IM10070	M10 x 70	151,147	17	100	400
D933IM04030	M4 x 30	18,517	7	500	6.000	D933IM10080	M10 x 80	177,847	17	100	400
D933IM04035	M4 x 35	22,220	7	250	6.000	D933IM10090	M10 x 90	200,363	17	50	300
D933IM04040	M4 x 40	24,707	7	250	6.000	D933IM10100	M10 x 100	226,077	17	50	300
D933IM05010	M5 x 10	11,110	8	500	8.000	D933IM12020	M12 x 20	121,863	19	100	600
D933IM05016	M5 x 16	13,023	8	500	-	D933IM12030	M12 x 30	126,757	19	100	600
D933IM05020	M5 x 20	14,750	8	500	6.000	D933IM12040	M12 x 40	142,853	19	100	400
D933IM05025	M5 x 25	16,953	8	500	4.000	D933IM12050	M12 x 50	164,857	19	100	400
D933IM05030	M5 x 30	19,633	8	500	4.000	D933IM12060	M12 x 60	187,900	19	100	400
D933IM05035	M5 x 35	21,743	8	250	3.000	D933IM12070	M12 x 70	211,187	19	100	-
D933IM05040	M5 x 40	24,423	8	250	3.000	D933IM12080	M12 x 80	263,870	19	50	300
D933IM05050	M5 x 50	29,887	8	250	3.000	D933IM12090	M12 x 90	288,893	19	50	300
D933IM06010	M6 x 10	18,637	10	250	6.000	D933IM12100	M12 x 100	313,927	19	25	150
D933IM06016	M6 x 16	19,743	10	250	4.000	D933IM14030	M14 x 30	238,857	22	50	300
D933IM06020	M6 x 20	22,873	10	250	4.000	D933IM14040	M14 x 40	261,600	22	50	300
D933IM06025	M6 x 25	23,767	10	250	3.000	D933IM14050	M14 x 50	298,000	22	50	300
D933IM06030	M6 x 30	27,613	10	250	3.000	D933IM14060	M14 x 60	338,943	22	50	200
D933IM06035	M6 x 35	31,227	10	250	2.000	D933IM14070	M14 x 70	377,613	22	50	200
D933IM06040	M6 x 40	34,517	10	250	2.000	D933IM14080	M14 x 80	405,613	22	25	150
D933IM06050	M6 x 50	40,960	10	250	1.500	D933IM14100	M14 x 100	556,327	22	25	150
D933IM08016	M8 x 16	36,437	13	200	1.600	D933IM16030	M16 x 30	263,757	24	50	300
D933IM08020	M8 x 20	39,493	13	200	1.600	D933IM16040	M16 x 40	280,067	24	50	200
D933IM08025	M8 x 25	44,583	13	200	1.600	D933IM16050	M16 x 50	312,313	24	50	200
D933IM08030	M8 x 30	49,567	13	200	1.200	D933IM16060	M16 x 60	355,310	24	50	200
D933IM08035	M8 x 35	54,540	13	200	1.200	D933IM16070	M16 x 70	396,043	24	25	150
D933IM08040	M8 x 40	60,203	13	200	1.200	D933IM16080	M16 x 80	449,020	24	25	150
D933IM08050	M8 x 50	72,443	13	200	800	D933IM16090	M16 x 90	518,110	24	25	150
D933IM08060	M8 x 60	82,680	13	200	800	D933IM16100	M16 x 100	561,237	24	25	100
D933IM08070	M8 x 70	99,077	13	200	800	D933IM18030	M18 x 30	527,307	27	25	100
D933IM08080	M8 x 80	113,240	13	100	600	D933IM18040	M18 x 40	557,707	27	25	200
D933IM08090	M8 x 90	125,463	13	100	600	D933IM18050	M18 x 50	609,220	27	25	150
D933IM08100	M8 x 100	140,770	13	100	600	D933IM18060	M18 x 60	680,887	27	25	150
D933IM10020	M10 x 20	74,233	17	200	800	D933IM18070	M18 x 70	757,020	27	25	100
D933IM10025	M10 x 25	77,853	17	200	800	D933IM18080	M18 x 80	828,710	27	25	100
D933IM10030	M10 x 30	85,317	17	200	800	D933IM18090	M18 x 90	900,387	27	25	100
D933IM10035	M10 x 35	93,013	17	200	800	D933IM18100	M18 x 100	972,060	27	25	100

Blíster

CÓDIGO	MEDIDA	€/BOLSA	PCS	BOLSAS
BZ3I04010	M4 x 10	2,561	6	20
BZ3I04016	M4 x 16	2,561	6	20
BZ3I04020	M4 x 20	2,561	6	20
BZ3I04030	M4 x 30	2,561	6	20
BZ3I04040	M4 x 40	2,561	6	20
BZ3I05010	M5 x 10	2,561	6	20
BZ3I05016	M5 x 16	2,561	6	20
BZ3I05020	M5 x 20	2,561	6	20
BZ3I05030	M5 x 30	2,561	6	20
BZ3I05040	M5 x 40	2,561	6	20
BZ3I05050	M5 x 50	2,561	6	20
BZ3I06016	M6 x 16	2,561	6	20
BZ3I06020	M6 x 20	2,561	6	20
BZ3I06025	M6 x 25	2,561	6	20
BZ3I06030	M6 x 30	2,561	6	20
BZ3I06040	M6 x 40	2,561	6	20
BZ3I06050	M6 x 50	2,561	6	20
BZ3I08016	M8 x 16	2,561	4	20
BZ3I08020	M8 x 20	2,561	4	20
BZ3I08025	M8 x 25	2,561	4	20
BZ3I08030	M8 x 30	2,561	4	20
BZ3I08040	M8 x 40	2,561	4	20
BZ3I08050	M8 x 50	2,561	4	20
BZ3I08060	M8 x 60	2,561	4	20
BZ3I10020	M10 x 20	2,561	2	20
BZ3I10030	M10 x 30	2,561	2	20
BZ3I10040	M10 x 40	2,561	2	20

Caja ventana

CÓDIGO	MEDIDA	€/CAJA	PCS	CAJAS
VD933I04010	M4 x 10	5,477	40	8
VD933I04016	M4 x 16	6,560	40	8
VD933I04020	M4 x 20	7,273	40	8
VD933I04030	M4 x 30	6,993	30	8
VD933I04040	M4 x 40	7,663	25	8
VD933I05010	M5 x 10	5,723	40	8
VD933I05016	M5 x 16	6,710	40	8
VD933I05020	M5 x 20	7,597	40	8
VD933I05030	M5 x 30	5,057	20	8
VD933I05040	M5 x 40	6,290	20	8
VD933I05050	M5 x 50	4,040	10	8
VD933I06010	M6 x 10	7,203	30	8
VD933I06016	M6 x 16	7,343	30	8
VD933I06020	M6 x 20	8,510	30	8
VD933I06025	M6 x 25	7,367	25	8
VD933I06030	M6 x 30	8,563	25	8
VD933I06040	M6 x 40	6,670	15	8
VD933I06050	M6 x 50	5,273	10	8
VD933I08016	M8 x 16	9,387	20	8
VD933I08020	M8 x 20	10,170	20	8
VD933I08025	M8 x 25	11,483	20	8
VD933I08030	M8 x 30	9,577	15	8
VD933I08040	M8 x 40	7,753	10	8
VD933I08050	M8 x 50	9,327	10	8
VD933I08060	M8 x 60	10,647	10	8
VD933I10020	M10 x 20	9,560	10	8
VD933I10030	M10 x 30	10,987	10	8
VD933I10040	M10 x 40	12,650	10	8
VD933I10050	M10 x 50	15,067	10	8
VD933I10060	M10 x 60	17,257	10	8

Tornillo cabeza hexagonal con arandela estampada y grafilada 8.8

DIN-6921

METAL



CÓDIGO	MEDIDA	€/100	LLAVE DE INSTALACIÓN		
6921108020	M8 x 20	50,524	13	200	2.400
6921108050	M8 x 50	80,818	13	100	600
6921108070	M8 x 70	117,304	13	100	600

DIN-6921 A2

Tornillo DIN-6921. Tornillo hexagonal con arandela estampada y grafilada. Inoxidable A2



Tornillo con cabeza redonda y cuello cuadrado. Inoxidable A2

DIN-603 A2

METAL



CÓDIGO	MEDIDA	€/100		
D603108016	M8 x 16	42,047	200	2.400



Disponible en varios recubrimientos. Consulte precio y plazo de entrega.

Tuerca hexagonal

DIN-934

INOXIDABLE



DIN-934 A2

Inoxidable A2

CÓDIGO	MEDIDA	€/100	LLAVE DE INSTALACIÓN		
D934IM04	M4	4,223	7	500	22.500
D934IM05	M5	4,883	8	500	12.000
D934IM06	M6	8,060	10	500	12.000
D934IM08	M8	16,347	13	250	4.000
D934IM10	M10	36,467	17	250	2.000
D934IM12	M12	53,467	19	250	1.500
D934IM14	M14	76,850	22	100	800
D934IM16	M16	107,843	24	100	600
D934IM18	M18	171,523	27	100	600
D934IM20	M20	225,217	30	50	400
D934IM22	M22	311,300	32	50	300
D934IM24	M24	404,683	36	25	200



 Blíster

 Caja ventana

CÓDIGO	MEDIDA	€/BOLSA	PCS 	BOLSAS 
BZ934IM04	M4	2,561	10	20
BZ934IM05	M5	2,561	8	20
BZ934IM06	M6	2,561	8	20
BZ934IM08	M8	2,561	6	20
BZ934IM10	M10	2,561	5	15

CÓDIGO	MEDIDA	€/CAJA	PCS 	CAJAS 
VD934IM04	M4	3,110	50	8
VD934IM05	M5	3,597	50	8
VD934IM06	M6	5,340	50	8
VD934IM08	M8	6,500	30	8
VD934IM10	M10	9,667	20	8

DIN-985

Tuerca autoblocante

DIN-985 A2

INOXIDABLE



Inoxidable A2



CÓDIGO	MEDIDA	€/100	LLAVE DE INSTALACIÓN		
D985IM04	M4	7,577	7	500	22.500
D985IM05	M5	8,157	8	500	8.000
D985IM06	M6	11,527	10	500	8.000
D985IM08	M8	22,720	13	250	4.000
D985IM10	M10	48,387	17	250	2.000
D985IM12	M12	75,213	19	100	1.200
D985IM14	M14	134,457	22	100	800
D985IM16	M16	162,963	24	50	600
D985IM18	M18	372,943	27	50	400
D985IM20	M20	478,307	30	25	300
D985IM22	M22	1.082,607	32	25	300
D985IM24	M24	1.459,673	36	25	150

Blíster

CÓDIGO	MEDIDA	€/BOLSA	PCS	BOLSAS
BZ985IM04	M4	2,561	10	20
BZ985IM05	M5	2,561	8	20
BZ985IM06	M6	2,561	8	20
BZ985IM08	M8	2,561	6	20
BZ985IM10	M10	2,561	5	15

Caja ventana

CÓDIGO	MEDIDA	€/CAJA	PCS	CAJAS
VD985IM04	M4	5,017	50	8
VD985IM05	M5	5,407	50	8
VD985IM06	M6	7,637	50	8
VD985IM08	M8	9,033	30	8
VD985IM10	M10	12,827	20	8

DIN-6923

Tuerca brida grafilada

DIN-6923 A2

METAL



Tuerca brida grafilada DIN-6923.
Inoxidable A2



CÓDIGO	MEDIDA	€/100	LLAVE DE INSTALACIÓN		
D6923IM08	M8	24,660	13	250	3.000
D6923IM10	M10	47,753	15	250	3.000
D6923IM12	M12	70,740	18	250	1.500

DIN-125

Arandela plana

DIN-125 A2

INOXIDABLE



Inoxidable A2



CÓDIGO	MEDIDA	€/100		
D125IM04	M4	1,323	500	22.500
D125IM05	M5	1,750	500	22.500
D125IM06	M6	3,170	500	22.500
D125IM08	M8	5,437	250	11.250
D125IM10	M10	10,387	250	6.000
D125IM12	M12	20,693	250	3.000
D125IM14	M14	28,960	200	2.400
D125IM16	M16	31,977	100	2.400
D125IM18	M18	47,420	100	1.600
D125IM20	M20	50,357	50	1.200
D125IM22	M22	59,713	50	1.200
D125IM24	M24	104,480	50	600

Blíster

CÓDIGO	MEDIDA	€/BOLSA	PCS	BOLSAS
BZ125IM04	M4	2,561	10	20
BZ125IM05	M5	2,561	8	20
BZ125IM06	M6	2,561	8	20
BZ125IM08	M8	2,561	6	20
BZ125IM10	M10	2,561	5	20

Caja ventana

CÓDIGO	MEDIDA	€/CAJA	PCS	CAJAS
VD125IM04	M4	3,143	100	8
VD125IM05	M5	3,153	75	8
VD125IM06	M6	3,987	75	8
VD125IM08	M8	4,157	50	8
VD125IM10	M10	6,927	50	8



Arandela plana ancha

DIN-9021

INOXIDABLE

DIN-9021 A2

Inoxidable A2

CÓDIGO	MEDIDA	€/100		
D9021IM04	M4	2,617	500	22.500
D9021IM05	M5	4,793	500	12.000
D9021IM06	M6	8,683	500	8.000
D9021IM08	M8	17,893	200	4.800
D9021IM10	M10	38,727	100	1.600
D9021IM12	M12	66,793	100	800
D9021IM14	M14	150,653	100	800
D9021IM16	M16	145,870	50	600
D9021IM18	M18	261,187	50	400
D9021IM20	M20	279,523	25	300
D9021IM22	M22	301,667	25	200
D9021IM24	M24	346,913	25	150



 Blíster

 Caja ventana

CÓDIGO	MEDIDA	€/BOLSA	PCS B	BOLSAS
BZ9021IM04	M4	2,561	10	20
BZ9021IM05	M5	2,561	8	20
BZ9021IM06	M6	2,561	8	20
BZ9021IM08	M8	2,561	6	20
BZ9021IM10	M10	2,561	5	20

CÓDIGO	MEDIDA	€/CAJA	PCS	CAJAS
VD9021IM04	M4	3,860	100	8
VD9021IM05	M5	4,763	75	8
VD9021IM06	M6	8,473	75	8
VD9021IM08	M8	9,077	40	8
VD9021IM10	M10	10,267	20	8

Arandela muelle Grower



DIN-127

METAL



DIN-127 A2

Arandela muelle grower DIN-127.
Inoxidable A2

CÓDIGO	MEDIDA	€/100		
D127IM08	M8	4,530	200	9.000
D127IM10	M10	7,237	100	4.500
D127IM12	M12	10,923	100	4.500



AB-RE

Abrazadera reforzada M8 + M10

AB-RE A2

Inoxidable A2



VENTAJAS

Tornillos con arandela plástica para evitar su pérdida
Tuerca M8/M10
Reforzada



INOXIDABLE



CÓDIGO	MEDIDA	ØD(mm)	€/100	MEDIDA EN PULGADAS	CARGA MÁXIMA		
ABREA2018	18 (M8+M10)	15 - 18	381,287	3/8"	150	50	300
ABREA2022	22 (M8+M10)	20 - 24	400,983	1/2"	150	50	200
ABREA2028	28 (M8+M10)	26 - 30	432,357	3/4"	150	50	150
ABREA2035	35 (M8+M10)	32 - 36	452,397	1"	150	50	100
ABREA2040	40 (M8+M10)	36 - 42	487,570	1 1/4"	150	25	100
ABREA2048	48 (M8+M10)	47 - 50	514,040	1 1/2"	150	25	100
ABREA2054	54 (M8+M10)	51 - 55	542,877	-	150	25	75
ABREA2060	60 (M8+M10)	60 - 64	577,370	2"	150	25	75
ABREA2075	75 (M8+M10)	75 - 80	642,317	2 1/2"	150	25	50
ABREA2090	90 (M8+M10)	87 - 92	739,043	3"	150	25	-
ABREA2110	110 (M8+M10)	106 - 112	799,543	-	150	25	-
ABREA2115	115 (M8+M10)	114 - 119	834,007	4"	150	25	-
ABREA2125	125 (M8+M10)	124 - 131	894,550	4 1/2"	150	25	-
ABREA2140	140 (M8+M10)	133 - 140	988,740	5"	150	25	-
ABREA2160	160 (M8+M10)	159 - 163	1.128,423	6"	150	25	-
ABREA2200	200 (M8+M10)	199 - 212	1.574,023	-	150	25	-

AB-RE A4

Inoxidable A4



VENTAJAS

Tornillos con arandela plástica para evitar su pérdida
Tuerca M8/M10
Reforzada



INOXIDABLE



CÓDIGO	MEDIDA	ØD(mm)	€/100	MEDIDA EN PULGADAS	CARGA MÁXIMA		
ABREA4018	18 (M8+M10)	15 - 18	457,357	3/8"	150	50	300
ABREA4022	22 (M8+M10)	20 - 24	469,737	1/2"	150	50	200
ABREA4028	28 (M8+M10)	26 - 30	501,680	3/4"	150	50	150
ABREA4035	35 (M8+M10)	32 - 36	554,910	1"	150	50	100
ABREA4040	40 (M8+M10)	36 - 42	578,710	1 1/4"	150	25	100
ABREA4048	48 (M8+M10)	47 - 50	643,087	1 1/2"	150	25	100
ABREA4054	54 (M8+M10)	51 - 55	670,917	-	150	25	75
ABREA4060	60 (M8+M10)	60 - 64	695,323	2"	150	25	75
ABREA4075	75 (M8+M10)	75 - 80	793,503	2 1/2"	150	25	50
ABREA4090	90 (M8+M10)	87 - 92	821,780	3"	150	25	-
ABREA4110	110 (M8+M10)	106 - 112	974,127	-	150	25	-
ABREA4115	115 (M8+M10)	114 - 119	1.045,083	4"	150	25	-
ABREA4125	125 (M8+M10)	124 - 131	1.101,010	4 1/2"	150	25	-
ABREA4140	140 (M8+M10)	133 - 140	1.340,527	5"	150	25	-
ABREA4160	160 (M8+M10)	159 - 163	1.430,610	-	150	25	-
ABREA4200	200 (M8+M10)	199 - 212	1.785,590	-	150	25	-

AB-RI

Abrazadera isofónica reforzada M8 + M10

AB-RI A2

Inoxidable A2



VENTAJAS

Tornillos con arandela plástica para evitar su pérdida
Tuerca M8/M10
Reforzada



INOXIDABLE



CÓDIGO	MEDIDA	ØD(mm)	€/100	MEDIDA EN PULGADAS	CARGA MÁXIMA		
ABRIA2018	18 (M8+M10)	15 - 18	461,010	3/8"	150	50	200
ABRIA2022	22 (M8+M10)	20 - 24	473,730	1/2"	150	50	150
ABRIA2028	28 (M8+M10)	26 - 30	494,807	3/4"	150	50	150
ABRIA2035	35 (M8+M10)	32 - 36	520,583	1"	150	50	100
ABRIA2040	40 (M8+M10)	36 - 42	575,100	1 1/4"	150	25	75
ABRIA2048	48 (M8+M10)	47 - 50	609,513	1 1/2"	150	25	75
ABRIA2054	54 (M8+M10)	51 - 55	653,360	-	150	25	50
ABRIA2060	60 (M8+M10)	60 - 64	688,830	2"	150	25	50
ABRIA2075	75 (M8+M10)	75 - 80	776,020	2 1/2"	150	25	-
ABRIA2090	90 (M8+M10)	87 - 92	815,723	3"	150	25	-
ABRIA2110	110 (M8+M10)	106 - 112	950,280	-	150	25	-
ABRIA2115	115 (M8+M10)	114 - 119	932,223	4"	150	25	-
ABRIA2125	125 (M8+M10)	124 - 131	1.033,450	4 1/2"	150	25	-
ABRIA2140	140 (M8+M10)	133 - 140	1.089,807	5"	150	25	-
ABRIA2160	160 (M8+M10)	159 - 163	1.222,713	6"	150	25	-

Abrazadera isofónica reforzada M8 + M10

AB-RI



02
P. 247
Info
Técnica

INOXIDABLE



AB-RI A4

Inoxidable A4

CÓDIGO	MEDIDA	ØD(mm)	€/100	MEDIDA EN PULGADAS	CARGA MÁXIMA		
ABRIA4018	18 (M8+M10)	15 - 18	572,757	3/8"	150	50	200
ABRIA4022	22 (M8+M10)	20 - 24	602,137	1/2"	150	50	150
ABRIA4028	28 (M8+M10)	26 - 30	628,520	3/4"	150	50	150
ABRIA4035	35 (M8+M10)	32 - 36	675,587	1"	150	50	100
ABRIA4040	40 (M8+M10)	36 - 42	728,183	1 1/4"	150	25	75
ABRIA4048	48 (M8+M10)	47 - 50	782,880	1 1/2"	150	25	75
ABRIA4054	54 (M8+M10)	51 - 55	821,610	-	150	25	50
ABRIA4060	60 (M8+M10)	60 - 64	898,087	2"	150	25	50
ABRIA4075	75 (M8+M10)	75 - 80	982,603	2 1/2"	150	25	-
ABRIA4090	90 (M8+M10)	87 - 92	1.078,133	3"	150	25	-
ABRIA4110	110 (M8+M10)	106 - 112	1.271,167	-	150	25	-
ABRIA4115	115 (M8+M10)	114 - 119	1.321,527	4"	150	25	-
ABRIA4125	125 (M8+M10)	124 - 131	1.400,003	4 1/2"	150	25	-
ABRIA4140	140 (M8+M10)	133 - 140	1.449,203	5"	150	25	-
ABRIA4160	160 (M8+M10)	159 - 163	1.739,243	6"	150	25	-



VENTAJAS

Tornillos con arandela plástica para evitar su pérdida
Tuerca M8/M10
Reforzada

Abarcón



AB-ZI

SANEAMIENTO



AB-ZI A2

Inoxidable A2

CÓDIGO	MEDIDA	€/100	CARGA MÁXIMA		
AZA2060500	M6 1/2"	114,353	250	100	600
AZA2060750	M6 3/4"	132,940	250	100	600
AZA2061000	M6 1"	163,783	250	100	400
AZA2061250	M6 1 1/4"	193,923	250	50	300
AZA2081500	M8 1 1/2"	337,000	350	50	150
AZA2082000	M8 2"	391,970	350	50	150
AZA2082500	M8 2 1/2"	441,640	350	50	100
AZA2083000	M8 3"	480,030	350	50	100
AZA2104000	M10 4"	976,667	350	50	-
AZA2106000	M10 6"	1.259,620	350	25	-
AZA2108000	M10 8"	1.506,923	350	25	-



Abrazadera inoxidable Indextube



AB-IT

SANEAMIENTO



AB-ITS

Simple

CÓDIGO	MEDIDA	€/100		
ABITS015	15	193,863	100	600
ABITS018	18	210,063	100	400
ABITS022	22	311,367	100	400
ABITS028	28	418,547	100	300



AB-IT

Abrazadera inoxidable Indextube

AB-ITD

Doble



SANEAMIENTO



CÓDIGO	MEDIDA	€/100		
ABITD015	15	716,737	50	300
ABITD018	18	811,463	50	200
ABITD022	22	1.016,350	50	100

AB-M6

Abrazadera M6

AB-M6 A2

Inoxidable A2



INOXIDABLE



CÓDIGO	MEDIDA	ØD(mm)	€/100	MEDIDA EN PULGADAS	CARGA MÁXIMA		
ABM6A2012	12 (M6)	12	257,013	1/4"	70	100	1.200
ABM6A2015	15 (M6)	14 - 15	261,657	-	70	100	600
ABM6A2018	18 (M6)	16 - 18	266,300	3/8"	70	100	600
ABM6A2020	20 (M6)	19 - 21	271,627	1/2"	70	100	600
ABM6A2022	22 (M6)	22 - 24	275,067	-	70	100	600
ABM6A2028	28 (M6)	25 - 30	290,510	3/4"	70	100	400

VENTAJAS

Tuerca soldada M6
Espesor 1,5 mm.

AB-SF

Abrazadera sin fin

AB-SF A2

Inoxidable A2



INOXIDABLE



CÓDIGO	MEDIDA	ØD(mm)	€/100	MEDIDA EN PULGADAS		
ASF2010016	10-16	10-16	95,663	-	100	1.200
ASF2012020	12-20	12-20	98,043	1/2" - 7/8"	100	600
ASF2016027	16-27	16 - 27	102,270	5/8" - 1 1/16"	100	600
ASF2020032	20-32	20 - 32	115,347	3/4" - 1 1/4"	100	600
ASF2025040	25-40	25 - 40	126,033	1" - 1 5/8"	100	200
ASF2032050	32-50	32 - 50	175,423	1 3/8" - 2"	100	300
ASF2040060	40-60	40 - 60	186,260	1 5/8" - 2 3/8"	100	200
ASF2050070	50-70	50 - 70	194,387	2" - 2 3/4"	50	100
ASF2060080	60-80	60 - 80	204,343	2 3/8" - 3 1/8"	50	100
ASF2070090	70-90	70 - 90	215,207	2 3/4" - 3 1/2"	50	100
ASF2080100	80-100	80 - 100	222,420	3 1/8" - 4"	50	100
ASF2090110	90-110	90 - 110	259,380	3 1/2" - 4 3/8"	50	100
ASF2100120	100-120	100 - 120	269,563	4" - 4 3/4"	25	25
ASF2110130	110-130	110 - 130	279,720	4 3/8" - 5 1/8"	25	25
ASF2120140	120-140	120 - 140	293,967	4 3/4" - 5 1/2"	25	25
ASF2130150	130-150	130 - 150	305,160	5 1/8" - 5 7/8"	25	25

Abrazadera sin fin inoxidable en rollo

AB-SF IR



INOXIDABLE



CÓDIGO	MEDIDA	€/PC		
ASFIR03	9 x 0,6 mm / 3 m	14,867	1	50

AB-SF IR

Kit (Rollo 3 m. + 8 cabezales).
Inoxidable



INOXIDABLE

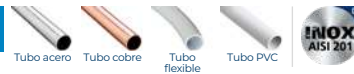

CÓDIGO	MEDIDA	€/100		
ASFIRCA	Cabezal	106,197	50	1.000

AB-SF IRC

Cabezal inoxidable



INOXIDABLE



CÓDIGO	MEDIDA	€/PC		
ASFIR30	9 x 0,6 mm / 30 m	53,097	1	10

AB-SF IRR

Rollo 30 m. Inoxidable



Cinta perforada

CI-PE



INOXIDABLE



CÓDIGO	MEDIDA	€/PC		
CIPEA21708	17 x 0,8 x 10 m	38,747	1	30

CI-PE A2

Cinta perforada curva. Inoxidable A2



SA

Soportes de fijación para sanitarios

SA-IL

Fijación de WC y bidé con taco largo.
2 PCS x KIT



SA-CI

Fijación de cisterna. 2 PCS x KIT



TAMBIÉN DISPONIBLE EN
easykits

GP

Perfiles para cargas ligeras tipo "C"

GP-A2

Guía perforada inoxidable A2



PE-AC

Accesorios para perfiles tipo "C"

EG-A2

Escuadra inoxidable A2



CÓDIGO	MEDIDA	€/KIT	KITS x
SAILO6080	M6 x 80	3,017	100



CÓDIGO	MEDIDA	€/KIT	KITS x
SACIO6080	M6 x 80	5,727	100



CÓDIGO	MEDIDA	€/100	LONGITUD	
GPI271812	27 x 18 x 1,25 x 2000	12.995,763	2.000	6
GPI283015	28 x 30 x 1,50 x 2000	20.997,927	2.000	6
GPI384020	38 x 40 x 2,00 x 2000	43.456,517	-	5



CÓDIGO	MEDIDA	VÁLIDO PARA	€/100		
EMI45	50 x 50 45°	27 / 18 - 28 / 30 - 38 / 40	634,667	50	200
EMI90	54 x 54 90°	27 / 18 - 28 / 30 - 38 / 40	634,667	50	-
EMI00	100 180°	27 / 18 - 28 / 30 - 38 / 40	629,223	50	200

Accesorios para perfiles tipo "C"

PE-AC

INOXIDABLE



CÓDIGO	MEDIDA	VÁLIDO PARA	€/100		
PGI2718	27 / 18 x 81	27/18	309,567	50	300
PGI2830	28 / 30 x 81	28/30	356,003	50	200
PGI3840	38 / 40 x 93	38/40	433,393	50	100

PG-A2

Puente guía inoxidable A2



Varilla roscada

RV

INOXIDABLE



CÓDIGO	MEDIDA	€/100	LONGITUD	PASO	
975A2M04	M4 x 1000	342,703	1.000	0.7	1
975A2M05	M5 x 1000	404,100	1.000	0.8	1
975A2M06	M6 x 1000	557,927	1.000	1	1
975A2M08	M8 x 1000	905,410	1.000	1.25	1
975A2M10	M10 x 1000	1.311,617	1.000	1.5	1
975A2M12	M12 x 1000	1.996,787	1.000	1.75	1
975A2M14	M14 x 1000	3.496,623	1.000	2	1
975A2M16	M16 x 1000	4.037,627	1.000	2	1
975A2M18	M18 x 1000	4.404,683	1.000	2.5	1
975A2M20	M20 x 1000	6.078,463	1.000	2.5	1
975A2M22	M22 x 1000	7.105,490	1.000	2.5	1
975A2M24	M24 x 1000	9.591,407	1.000	3	1
975A2M27	M27 x 1000	11.559,623	1.000	3	1
975A2M30	M30 x 1000	17.990,670	1.000	3.5	1
975A2M33	M33 x 1000	22.586,227	1.000	3.5	1
975A2M36	M36 x 1000	25.977,823	1.000	4	1

RV-A2

Inoxidable A2. 1 metro





Manguito de unión

MA

INOXIDABLE



CÓDIGO	MEDIDA	€/100	LONGITUD		
MARIO830	M8 x 30	204,683	30	100	2.400
MARIO1030	M10 x 30	281,790	30	100	-

MA-RI

Redondo. Inoxidable A2





Tirafondo abrazadera y grapa

TAG

 Info Técnica
P. 274

INOXIDABLE



CÓDIGO	MEDIDA	€/100		
ABTA20630	M6 x 30	84,600	100	2.400

AB-TA A2

Inoxidable A2



ES-DR

Espárrago de doble rosca

ES-DA2

Inoxidable A2. TX



INOXIDABLE



CÓDIGO	MEDIDA	€/100	LLAVE DE INSTALACIÓN		
ESDA208060	M8 x 60	131,207	6	100	800
ESDA210060	M10 x 60	221,897	8	100	800

ISF-CC

Conectores + Complementos para montaje de estructuras solares

TU-RX A2

Tuerca rapida INDEXTRUT. Inoxidable A2

METAL



CÓDIGO	MEDIDA	€/100		
TURXA208	M8	141,599	50	300

ISF-FD

Accesorios de fijación directa para la instalación de placas solares

TAC BIMETAL+ARVUL A2

Tornillo de cosido Bimetal + Arandela vulcanizada EPDM-inoxidable A2

METAL



CÓDIGO	MEDIDA	€/100	Nº HUELLA		
TACB166025	6 x 25 P16	99,783	8	500	2.000

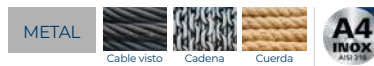

Cáncamo hembra D-582

EV-H



EV-H A4 **NEW**

Inoxidable A4

CÓDIGO	MÉTRICA	Ø CABLE	€/100		
EVHA406	M6	20	209,411	10	450
EVHA408	M8	20	337,913	10	450
EVHA410	M10	25	642,510	10	240
EVHA412	M12	30	951,867	5	120
EVHA414	M14	35	1.427,800	5	120
EVHA416	M16	35	1.665,767	1	-
EVHA420	M20	40	2.189,293	1	-
EVHA424	M24	50	4.759,333	1	-



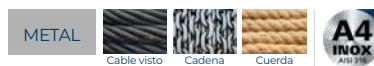

Cáncamo macho D-580

EV-M



EV-M A4 **NEW**

Inoxidable A4

CÓDIGO	MÉTRICA	Ø CABLE	€/100		
EVMA406	M6	20	223,689	10	450
EVMA408	M8	20	385,506	10	450
EVMA410	M10	25	690,103	10	240
EVMA412	M12	30	1.047,053	5	120
EVMA414	M14	35	1.546,783	5	120
EVMA416	M16	35	1.808,547	1	-
EVMA420	M20	40	2.617,633	1	-
EVMA424	M24	50	5.711,200	1	-



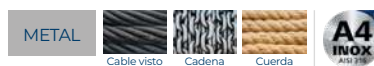

Guardacabo DIN-6899/A

GD



GD-A4 **NEW**

Inoxidable A4

CÓDIGO	MÉTRICA	Ø CABLE	€/100		
GDA402	M2	10	39,502	100	4.500
GDA403	M3	12	57,112	100	4.500
GDA404	M4	13	66,631	50	2.250
GDA405	M5	14	90,427	50	1.200
GDA406	M6	15	104,705	50	1.200
GDA408	M8	18	199,892	50	600
GDA410	M10	22	328,394	25	300
GDA412	M12	26	385,506	10	120
GDA415	M15	32	666,307	5	60



GI

Grillete lira

NEW GI-A4

Inoxidable A4



METAL



CÓDIGO	MÉTRICA	Ø CABLE	€/100		
GI A404	M4	6	266,523	25	1.125
GI A405	M5	8	290,319	25	1.125
GI A406	M6	10	318,875	10	450
GI A408	M8	12	475,933	10	240
GI A410	M10	16	785,290	10	120
GI A412	M12	28	1.237,427	5	60
GI A414	M14	33	2.141,700	5	60
GI A416	M16	37	2.926,990	5	30

GR

Grillete recto

NEW GR-A4

Inoxidable A4



METAL



CÓDIGO	MÉTRICA	Ø CABLE	€/100		
GRA404	M4	8	209,411	25	1.125
GRA405	M5	10	228,448	25	1.125
GRA406	M6	12	261,763	25	600
GRA408	M8	16	390,265	10	240
GRA410	M10	19	628,232	10	120
GRA412	M12	25	989,941	5	60
GRA414	M14	28	1.594,377	5	60
GRA416	M16	32	2.284,480	5	40
GRA419	M20	38	4.473,773	1	-
GRA425	M25	50	9.613,853	1	-

SJ-P

Sujetacable plano

NEW SJ-PD A4

Doble. Inoxidable A4



METAL



CÓDIGO	MÉTRICA	Ø CABLE	€/100		
SJPDA40403	M4	3	166,577	30	720
SJPDA40504	M5	4	271,282	30	720
SJPDA40605	M5	5	337,913	20	480
SJPDA40606	M6	6	585,398	10	240

NEW SJ-PS A4

Simple. Inoxidable A4



METAL





CÓDIGO	MÉTRICA	Ø CABLE	€/100		
SJPSA40403	M4	3	99,946	30	1.350
SJPSA40504	M5	4	147,539	30	1.350
SJPSA40605	M6	5	204,651	20	900
SJPSA40606	M6	6	347,431	10	450

Tensor anilla/anilla DIN-1480

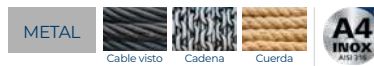
TS-AA



CÓDIGO	MÉTRICA	Ø CABLE	€/100		
TSAAA405	M5	8	5,092	10	240
TSAAA406	M6	10	7,139	10	120
TSAAA408	M8	11	12,517	10	60
TSAAA410	M10	14	18,561	5	20
TSAAA412	M12	17	34,981	5	20

TS-AA A4 **NEW**



Inoxidable A4

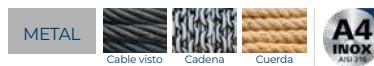

Tensor gancho/anilla DIN-1480

TS-GA



CÓDIGO	MÉTRICA	Ø CABLE	€/100		
TSGAA405	M5	5	5,092	10	240
TSGAA406	M6	8	7,139	10	120
TSGAA410	M10	12	18,561	5	30
TSGAA412	M12	17	34,981	5	30

TS-GA A4 **NEW**

Inoxidable A4



Tensor gancho/gancho DIN-1480

TS-GG

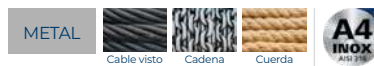

CÓDIGO	MÉTRICA	Ø CABLE	€/100		
TSGGA405	M5	8	5,092	10	240
TSGGA406	M6	10	7,139	10	120
TSGGA408	M8	11	12,517	10	-
TSGGA410	M10	14	18,561	5	20
TSGGA412	M12	17	34,981	5	15

TS-GG A4 **NEW**



Inoxidable A4

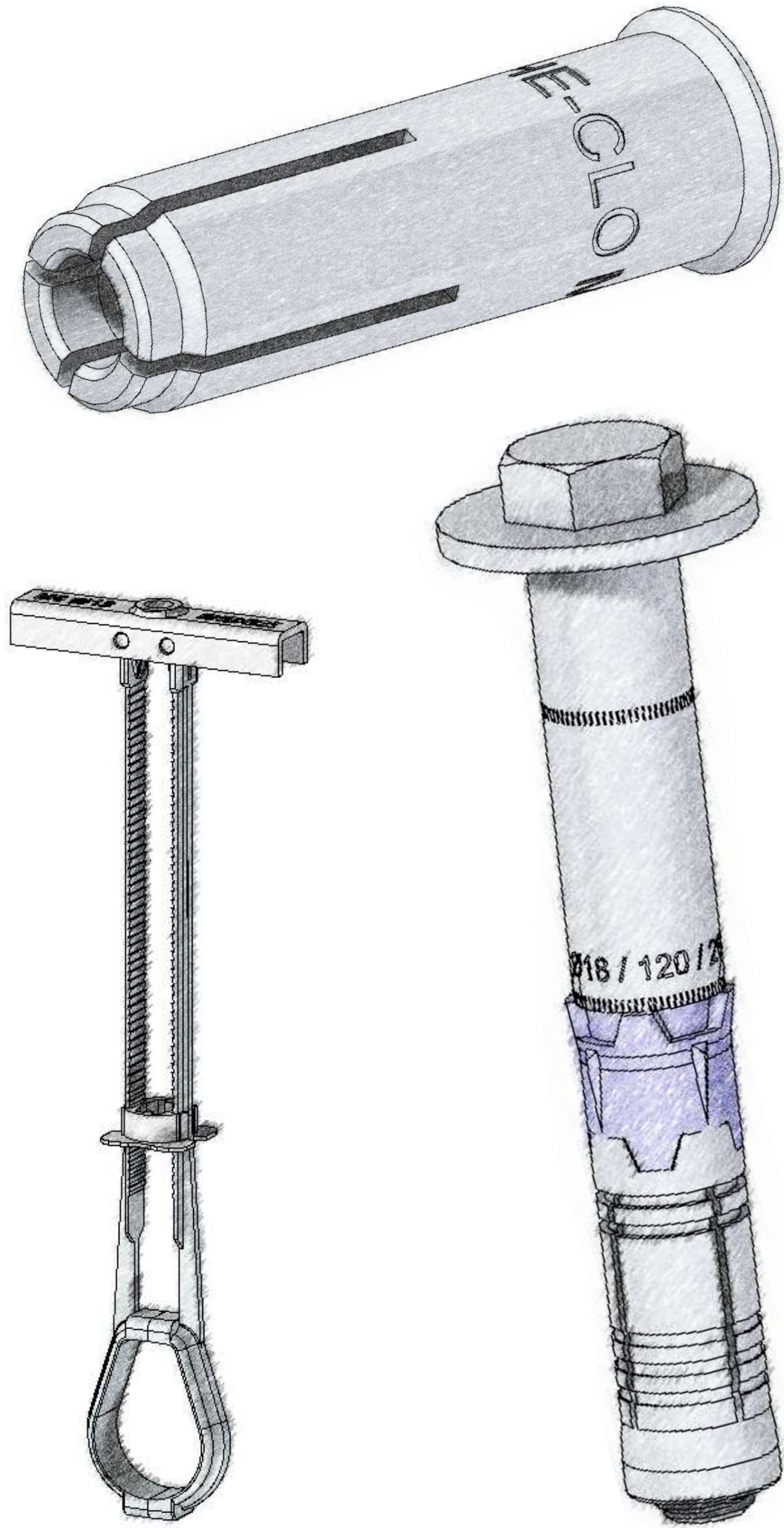

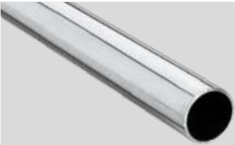
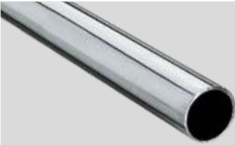

CARACTERÍSTICAS TÉCNICAS

PESOS DE TUBERÍAS SEGÚN MATERIALES PARA CÁLCULO DE CARGAS

		Ø exterior (mm)	Ø interior (mm)	Peso tubo vacío con manguito (kg/m)	Peso tubo lleno de agua con manguito (kg/m)
 <p>ACERO UNE 19047:1996</p>	3/8"	17,2	12,6	0,89	1,01
	1/2"	21,3	16,1	1,26	1,46
	3/4"	26,9	21,7	1,63	2,00
	1"	33,7	27,3	2,50	3,09
	1 1/4"	42,4	36	3,23	4,25
	1 1/2"	48,3	41,9	3,75	5,13
	2"	60,3	53,1	5,26	7,47
	2 1/2"	76,1	68,9	6,76	10,49
	3"	88,9	80,9	8,79	13,93
	4"	114,3	105,3	12,90	21,61
	5"	139,7	129,7	17,50	30,71
6"	165,1	155,1	20,80	39,69	
 <p>INOXIDABLE UNE 19049-1:1997</p>	6	6	4,8	0,08	0,10
	8	8	6,8	0,11	0,15
	10	10	8,8	0,14	0,20
	12	12	10,8	0,17	0,26
	15	15	13,8	0,21	0,36
	18	18	16,6	0,30	0,52
	22	22	20,6	0,37	0,70
	28	28	26,4	0,54	1,08
	35	35	33	0,84	1,69
	42	42	39,8	1,11	2,35
	54	54	51,6	1,56	3,65
	66,7	66,7	64,3	2,45	5,70
	76,1	76,1	73,1	2,45	6,64
	88,9	88,9	84,9	4,35	10,01
108	108	104	5,31	13,80	
 <p>PVC F (pluvial) UNE 53.114</p>	32	32	28,4	0,24	0,87
	40	40	36,4	0,30	1,34
	50	50	46,4	0,38	2,07
	83	83	79,4	0,64	5,59
	110	110	105,6	1,04	9,80
	125	125	120	1,35	12,66
 <p>PVC C (fecal) UNE 53.114</p>	32	32	25,6	0,41	0,92
	40	40	33,6	0,52	1,40
	50	50	43,6	0,66	2,15
	83	83	76,6	1,12	5,73
	110	110	103,6	1,50	9,93
	125	125	118,6	1,71	12,76
	160	160	153,6	2,21	20,74
	200	200	192	3,45	32,40

		Ø exterior (mm)	Ø interior (mm)	Peso tubo vacío con manguito (kg/m)	Peso tubo lleno de agua con manguito (kg/m)
 PVC UNE 53.332	110	110	103,6	1,50	9,93
	125	125	118,6	1,71	12,76
	160	160	152,2	2,68	20,87
	200	200	190,2	4,20	32,62
	250	250	237,8	6,54	50,96
	315	315	299,6	10,41	80,90
	400	400	380,4	16,82	130,47
 COBRE UNE EN 1057:1996	4 - 6	6	4	0,14	0,15
	6 - 8	8	6	0,20	0,22
	8 - 10	10	8	0,25	0,30
	10 - 12	12	10	0,31	0,39
	12 - 14	14	12	0,36	0,48
	13 - 15	15	13	0,39	0,52
	14 - 16	16	14	0,42	0,57
	16 - 18	18	16	0,48	0,68
	20 - 22	22	20	0,59	0,90
	23 - 25	25	23	0,67	1,09
	26 - 28	28	26	0,76	1,29
	33 - 35	35	33	0,95	1,81
	38 - 40	40	38	1,09	2,23
	40 - 42	42	40	1,15	2,40
	51,6 - 54	54	51,6	1,77	3,87
	60 - 64	64	60	3,47	6,30
	62,7 - 66,7	66,7	62,7	3,62	6,71
	66 - 70	70	66	3,81	7,23
	72,1 - 76,1	76,1	72,1	4,15	8,23
	76-80	80	76	4,37	8,90
84,9 - 88,9	88,9	84,9	4,87	10,53	
104 - 108	108	104	5,94	14,43	
129 - 133	133	129	7,34	20,41	
155 - 159	159	155	8,79	27,66	
213 - 219	219	213	18,14	53,77	
261 - 267	267	261	22,18	75,68	

* Pesos orientativos. Consultar fabricante para pesos reales.

EJEMPLOS DE CÁLCULO DE CARGAS

En el diseño de los sistemas de soportación de tuberías deben aplicarse aspectos básicos de la teoría de resistencia de materiales. En el sistema que vaya a ser diseñado, para calcular la fijación de tuberías deberá considerarse el elemento más desfavorable del sistema.

1. ELEMENTO SUSPENDIDO

Elementos de fijación

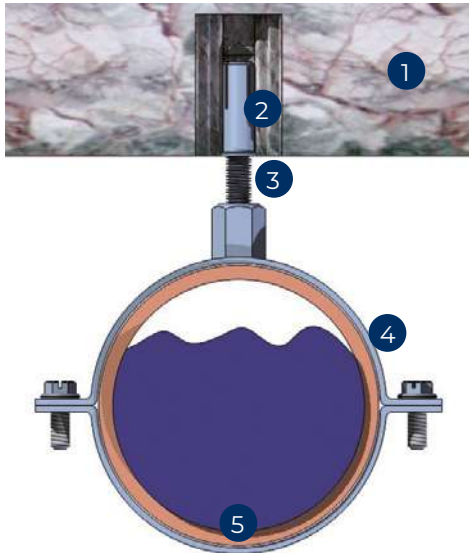

- 1 Material base
- 2 Anclaje
- 3 Elemento de suspensión
- 4 Abrazadera
- 5 Tubería

Cargas y resistencias

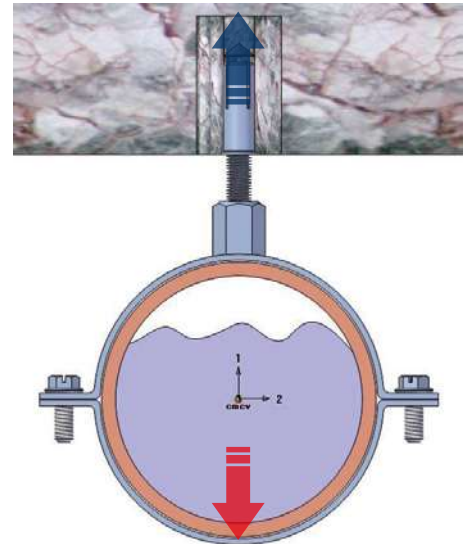

CÁLCULO DE RESISTENCIA

Cargas de servicio		Resistencia recomendada de los componentes
Peso tubo + Peso fluido	≤	HE-NO DIN-975 AB-RI

Cargas de servicio

Tubería de PVC Ø125 mm + fluido
(separación entre soportes: 1 metro)
= 12,76 kg/m *

*Consultar datos en las fichas técnicas de producto en indexfix.com y catálogo INDEX.

Resistencia de los componentes

Elemento	Resistencia * característica	Coficiente * de seguridad	Resistencia * recomendada
Anclaje hembra HENOM8	8,30 N	CS rotura acero 2,16 CS mayoración cargas 1,4	279 kg
Varilla roscada 975ZM8	15.400 N	CS rotura acero 1,25 CS mayoración cargas 1,4	897 kg
Abrazadera ABRI125	-	-	200 kg

El elemento más desfavorable es la abrazadera, ABRI125 con 200 kg de resistencia recomendada.

$$\text{Carga servicio} \leq \text{Resistencia recomendada}$$

$$12,76 \text{ kg} \leq 200 \text{ kg}$$

Por tanto, el sistema de sujeción de la tubería es seguro.

2. ELEMENTO SOBRE CARRIL DE SOPORTACIÓN

Elementos de fijación

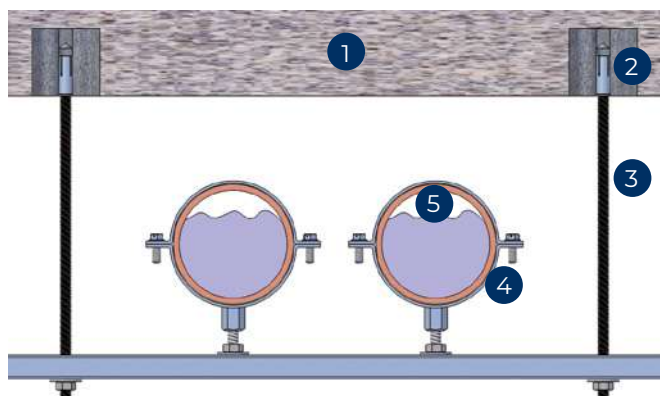

- 1 Material base
- 2 Anclaje
- 3 Elemento de suspensión
- 4 Abrazadera
- 5 Tubería

Cargas y resistencias

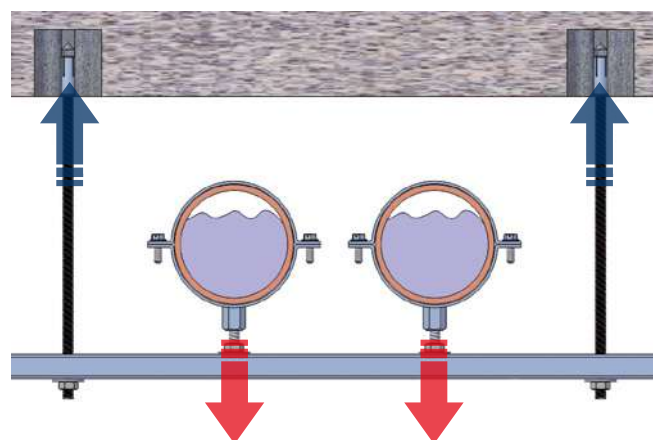

CÁLCULO DE RESISTENCIA

Cargas de servicio		Resistencia recomendada de los componentes
Peso 2 tubos + Peso fluido	≤	2 HE-NO 2 DIN-975 2 AB-RI 1 GPG3840

Resistencia de los componentes

Cargas de servicio

2 Tuberías de PVC Ø125 mm + fluido
(separación entre soportes: 2 metros)
= 12,76 kg/m x 2 x 2 = 51,04 kg*

Elemento	Resistencia * característica	Coefficiente * de seguridad	Resistencia * recomendada	Unidades	Resistencia * recomendada total
Anclaje hembra HENOMB	8,30 N	CS rotura acero 2,16 CS mayoración cargas 1,4	279 kg	2	558
Varilla roscada 975ZM8	15,400 N	CS rotura acero 1,25 CS mayoración cargas 1,4	897 kg	2	1.794
Abrazadera ABRI115	-	-	200 kg	2	400
Perfil soportación GPG3840	Consultar apartado de soportación		260 kg	2	260

*Consultar datos en las fichas técnicas de producto en indexfix.com y catálogo INDEX.

Los elementos más desfavorables son la abrazadera ABRI125, con 200 kg de resistencia recomendada; y el perfil de soportación GPG3840, con 260 kg de resistencia recomendada.

Carga de servicio ≤ Resistencia recomendada

ABRI125: 25,52 kg ≤ 200 kg
GPG3840: 51,04 kg ≤ 260 kg

Por lo tanto, el sistema de sujeción de las tuberías es seguro.

PARÁMETROS TÉCNICOS DE INSTALACIÓN

En las siguientes páginas encontrarás una serie de datos de consulta rápida que te ayudarán a elegir el producto adecuado para tu instalación. Si deseas ampliar esta información puedes consultar nuestra documentación técnica en: www.indexfix.com

Los datos que primero encontrarás son de carácter descriptivo y nos ayudan a entender la geometría del anclaje y su código de referencia correspondiente. Los siguientes son parámetros de instalación del producto, utilizando como unidades de distancia los mm, kg para las cargas máximas recomendadas y Nm para el par de apriete de los anclajes.

La mayoría de productos vienen acompañados de un croquis acotado, el significado de estas cotas para los anclajes se describe a continuación:

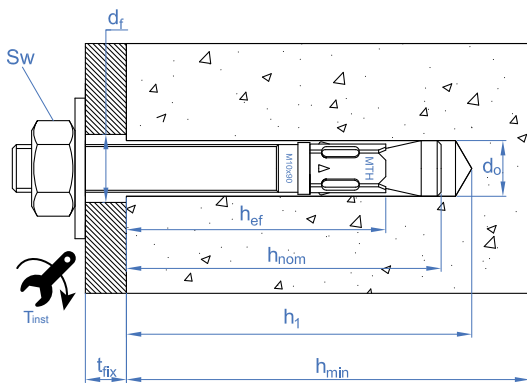

d_o	diámetro de broca o diámetro del taladro [mm]
h_1	profundidad mínima del taladro o agujero [mm]
h_{min}	espesor mínimo del material base [mm]
d_f	diámetro del agujero del elemento a fijar [mm]
h_{nom}	profundidad de instalación del anclaje [mm]
t_{fix}	espesor máximo a fijar [mm]
t_{inst}	par de apriete necesario para la correcta expansión del anclaje [Nm]
C_{cr}	distancia crítica al borde [mm]
S_c	distancia crítica entre anclajes [mm]
h_{ef}	profundidad efectiva del anclaje [mm]
SW	llave de instalación o distancia entre caras de la tuerca [mm]

EXTRACCIÓN

Carga máxima recomendada a tracción que puede resistir el anclaje. Ésta ha sido calculada aplicando un factor de seguridad 1.4 a la resistencia de cálculo del anclaje y está expresada en kg. Este factor aplica para hormigón fisurado y no fisurado. Para otros materiales el factor de seguridad puede llegar hasta 2.5.

CIZALLADURA

Carga máxima recomendada a cortante que puede resistir el anclaje. Ésta ha sido calculada aplicando un factor de seguridad 1.4 a la resistencia de cálculo del anclaje y está expresada en kg. Este factor aplica para hormigón fisurado y no fisurado. Para otros materiales el factor de seguridad puede llegar hasta 2.5.

AB-IA / AB-RA Abrazadera reforzada M8 abierta



AB-RA / AB-IA Abrazadera reforzada M8 Abierta

CÓDIGO	ØD(MM)	ØD(")	A X B	CARGA MÁXIMA
ABIA015 / ABRA015	12 - 16	1/4"	20 x 1,5	80
ABIA018 / ABRA018	15 - 19	3/8"	20 x 1,5	80
ABIA022 / ABRA022	20 - 25	1/2"	20 x 1,5	80
ABIA028 / ABRA028	26 - 30	3/4"	20 x 1,5	80
ABIA035 / ABRA035	32 - 36	1"	20 x 1,5	80
ABIA042 / ABRA042	38 - 43	1 1/4"	20 x 1,5	80
ABIA048 / ABRA048	47 - 51	1 1/2"	20 x 1,5	80
ABIA054 / ABRA054	53 - 58	-	20 x 1,5	80
ABIA060 / ABRA060	60 - 64	2"	20 x 1,5	80
ABIA075 / ABRA075	75 - 80	2 1/2"	20 x 1,5	80
ABIA090 / ABRA090	87 - 92	3"	20 x 1,5	80
ABIA100 / ABRA100	99 - 105	3 1/2"	20 x 1,5	80
ABIA110 / ABRA110	107 - 112	-	20 x 1,5	80
ABIA115 / ABRA115	113 - 118	4"	20 x 1,5	80
ABIA125 / ABRA125	125 - 130	4 1/2"	20 x 1,5	80

AB-IR Abrazadera isofónica M8 instalación rápida

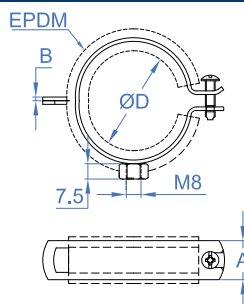

AB-IR Abrazadera isofónica M8 instalación rápida

CÓDIGO	ØD(MM)	ØD(")	A X B	CARGA MÁXIMA
ABIR015	14 - 15	1/4"	19 x 1,25	60
ABIR018	16 - 19	3/8"	19 x 1,25	60
ABIR022	21 - 23	1/2"	19 x 1,25	60
ABIR028	26 - 28	3/4"	19 x 1,25	60
ABIR035	32 - 35	1"	19 x 1,25	60
ABIR040	40 - 43	1 1/4"	19 x 1,25	60
ABIR048	48 - 51	1 1/2"	19 x 1,25	60
ABIR054	52 - 56	-	19 x 1,25	60
ABIR060	57 - 60	2"	19 x 1,25	60

AB-RI / AB-RE Abrazadera isofónica reforzada M8 + M10

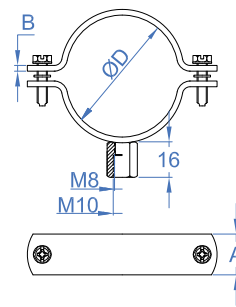
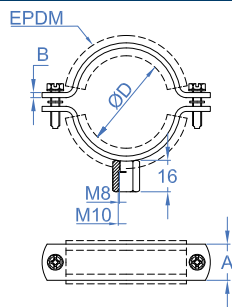

AB-RI / AB-RE Cincada

CÓDIGO	ØD(MM)	ØD(")	A X B	CARGA MÁXIMA
ABRI018 / ABRE018	15 - 19	3/8"	18,5x1,35	80
ABRI022 / ABRE022	20 - 25	1/2"	18,5x1,35	80
ABRI028 / ABRE028	26 - 30	3/4"	18,5x1,35	80
ABRI035 / ABRE035	32 - 36	1"	18,5x1,35	80
ABRI040 / ABRE040	38 - 43	1 1/4"	18,5x1,35	80
ABRI048 / ABRE048	47 - 51	1 1/2"	18,5x1,35	80
ABRI054 / ABRE054	53 - 56	-	18,5x1,35	80
ABRI060 / ABRE060	60 - 64	2"	18,5x1,35	80
ABRI070 / ABRE070	68 - 72	-	18,5x1,35	80
ABRI075 / ABRE075	75 - 80	2 1/2"	18,5x1,75	150
ABRI083 / ABRE083	81 - 86	-	18,5x1,75	150
ABRI090 / ABRE090	87 - 92	3"	18,5x1,75	150
ABRI100 / ABRE100	99 - 105	3 1/2"	18,5x1,75	150
ABRI110 / ABRE110	107 - 112	-	18,5x1,75	150
ABRI115 / ABRE115	113 - 118	4"	18,5x2,3	200
ABRI125 / ABRE125	125 - 130	4 1/2"	18,5x2,3	200
ABRI133 / ABRE133	132 - 137	-	18,5x2,3	200
ABRI140 / ABRE140	138 - 142	5"	18,5x2,3	200
ABRI150 / ABRE150	148 - 152	-	18,5x2,3	200
ABRI160 / ABRE160	159 - 166	6"	18,5x2,3	200
ABRI180 / ABRE180	179 - 184	-	18,5x2,3	200
ABRI200 / ABRE200	199 - 212	-	18,5x2,3	200
ABRI220 / ABRE220	215 - 226	8"	18,5x2,3	200
ABRI250 / ABRE250	245 - 254	-	18,5x2,3	200
ABRI280 / ABRE280	278 - 284	-	18,5x2,3	200
ABRI300 / ABRE300	299 - 304	-	18,5x2,3	200
ABRI315 / ABRE315	314 - 319	-	18,5x2,3	200
ABRI355 / ABRE355	354 - 359	-	18,5x2,3	200

AB-RI V / AB-RE V Cincada. Ventilación

CÓDIGO	ØD(MM)	ØD(")	A X B	CARGA MÁXIMA
ABRI250 / ABRE250	245 - 254	-	18,5x2,3	200
ABRI280 / ABRE280	278 - 284	-	18,5x2,3	200
ABRI300 / ABRE300	299 - 304	-	18,5x2,3	200
ABRI315 / ABRE315	314 - 319	-	18,5x2,3	200
ABRI355 / ABRE355	354 - 359	-	18,5x2,3	200
ABRI400 / ABRE400	399 - 404	-	18,5x2,3	200
ABRI450 / ABRE450	449 - 454	-	18,5x2,3	200
ABRI500 / ABRE500	499 - 504	-	18,5x2,3	200
ABRI560 / ABRE560	555 - 561	-	18,5x2,3	200
ABRI600 / ABRE600	599 - 604	-	18,5x2,3	200
ABRI630 / ABRE630	625 - 631	-	18,5x2,3	200
ABRI710 / ABRE710	705 - 711	-	18,5x2,3	200
ABRI800 / ABRE800	799 - 804	-	18,5x2,3	200
ABRI900 / ABRE900	899 - 904	-	18,5x2,3	200
ABRI910 / ABRE910	999 - 1.004	-	18,5x2,3	200
ABRI911 / ABRE911	1.115 - 1.121	-	18,5x2,3	200
ABRI912 / ABRE912	1.245 - 1.251	-	18,5x2,3	200

AB-RI A2 / AB-RI A4 Abrazadera isofónica reforzada M8 + M10



AB-RI A2 / AB-RI A4 Inoxidable A2

CÓDIGO	ØD(MM)	ØD(")	A X B	CARGA MÁXIMA
ABRIA2018 / ABRIA4018	15 - 18	3/8"	18,5X1,7	150
ABRIA2022 / ABRIA4022	20 - 24	1/2"	18,5X1,7	150
ABRIA2028 / ABRIA4028	26 - 30	3/4"	18,5X1,7	150
ABRIA2035 / ABRIA4035	32 - 36	1"	18,5X1,7	150
ABRIA2040 / ABRIA4040	36 - 42	1 1/4"	18,5X1,7	150
ABRIA2048 / ABRIA4048	47 - 50	1 1/2"	18,5X1,7	150
ABRIA2054 / ABRIA4054	51 - 55	-	18,5X1,7	150
ABRIA2060 / ABRIA4060	60 - 64	2"	18,5X1,7	150
ABRIA2075 / ABRIA4075	75 - 80	2 1/2"	18,5X1,7	150
ABRIA2090 / ABRIA4090	87 - 92	3"	18,5X1,7	150
ABRIA2110 / ABRIA4110	106 - 112	-	18,5X1,7	150
ABRIA2115 / ABRIA4115	114 - 119	4"	18,5X1,7	150
ABRIA2125 / ABRIA4125	124 - 131	4 1/2"	18,5X1,7	150
ABRIA2140 / ABRIA4140	133 - 140	5"	18,5X1,7	150
ABRIA2160 / ABRIA4160	159 - 163	6"	18,5X1,7	150

AB-RE A2 / AB-RE A4 Abrazadera reforzada M8 + M10



AB-RE A2 / AB-RE A4 Inoxidable A2

CÓDIGO	ØD(MM)	ØD(")	A X B	CARGA MÁXIMA
ABREA2018 / ABREA4018	15 - 18	3/8"	18,5X1,7	150
ABREA2022 / ABREA4022	20 - 24	1/2"	18,5X1,7	150
ABREA2028 / ABREA4028	26 - 30	3/4"	18,5X1,7	150
ABREA2035 / ABREA4035	32 - 36	1"	18,5X1,7	150
ABREA2040 / ABREA4040	36 - 42	1 1/4"	18,5X1,7	150
ABREA2048 / ABREA4048	47 - 50	1 1/2"	18,5X1,7	150
ABREA2054 / ABREA4054	51 - 55	-	18,5X1,7	150
ABREA2060 / ABREA4060	60 - 64	2"	18,5X1,7	150
ABREA2075 / ABREA4075	75 - 80	2 1/2"	18,5X1,7	150
ABREA2090 / ABREA4090	87 - 92	3"	18,5X1,7	150
ABREA2110 / ABREA4110	106 - 112	-	18,5X1,7	150
ABREA2115 / ABREA4115	114 - 119	4"	18,5X1,7	150
ABREA2125 / ABREA4125	124 - 131	4 1/2"	18,5X1,7	150
ABREA2140 / ABREA4140	133 - 140	5"	18,5X1,7	150
ABREA2160 / ABREA4160	159 - 163	6"	18,5X1,7	150
ABREA2200 / ABREA4200	199 - 212	-	18,5X1,7	150

AB-GA

Abrazadera gásmica M8 + M10 amarilla

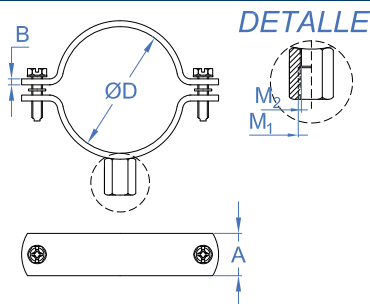

AB-GA

Abrazadera gásmica M8 + M10 amarilla

CÓDIGO	ØD(MM)	ØD(")	A X B	MÉTRICA	CARGA MÁXIMA
ABGA018	15 - 18	3/8"	20 x 2	M8	200
ABGA022	20 - 24	1/2"	20 x 2	M8	200
ABGA028	26 - 30	3/4"	20 x 2	M8	200
ABGA035	32 - 36	1"	20 x 2	M8	200
ABGA040	38 - 42	1 1/4"	20 x 2	M8	200
ABGA048	47 - 50	1 1/2"	20 x 2	M8	200
ABGA054	52 - 56	-	20 x 2	M8	200
ABGA060	60 - 64	2"	20 x 2	M8/M10	200
ABGA075	75 - 80	2 1/2"	20 x 2	M8/M10	200
ABGA090	85 - 90	3"	20 x 2	M8/M10	200
ABGA100	99 - 105	3 1/2"	20 x 2	M8/M10	200
ABGA110	107 - 112	-	20 x 2	M8/M10	200
ABGA115	113 - 118	4"	20 x 2	M8/M10	200
ABGA140	138 - 142	5"	20 x 2	M8/M10	200
ABGA160	159 - 166	6"	20 x 2	M8/M10	200

AB-M8

Abrazadera desagüe M8

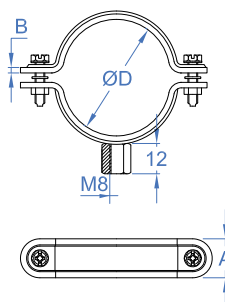

AB-M8

Abrazadera desagüe M8

CÓDIGO	ØD(MM)	ØD(")	A X B	CARGA MÁXIMA
ABM8050	49 - 54	-	28 x 0,8	100
ABM8063	60 - 65	-	28 x 0,8	100
ABM8075	75 - 80	-	28 x 0,8	100
ABM8090	88 - 92	-	28 x 0,8	100
ABM8110	108 - 113	-	28 x 0,8	100
ABM8125	124 - 130	-	28 x 0,8	100
ABM8160	159 - 165	-	28 x 0,8	100
ABM8200	199 - 203	-	28 x 0,8	100
ABM8250	249 - 254	-	28 x 0,8	100
ABM8315	314 - 319	-	28 x 0,8	100

AB-DE Z / AB-DE G Abrazadera desagüe de empotrar

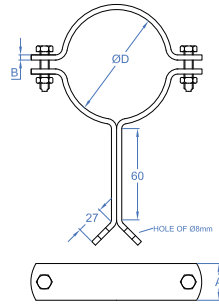

AB-DE Z / AB-DE G Zincada / Galvanizada

CÓDIGO	ØD(MM)	ØD(ʹ)	A X B	CARGA MÁXIMA
ABDE075	75 - 80	2 1/2ʹ	20 x 2,5	200
ABDE090	87 - 92	3ʹ	20 x 2,5	200
ABDE110	107 - 112	-	20 x 2,5	200
ABDE125	125 - 130	4 1/2ʹ	20 x 2,5	200
ABDE160	159 - 166	6ʹ	20 x 2,5	200
ABDE200	199 - 212	-	20 x 2,5	200
ABDE250	245 - 254	-	20 x 2,5	200
ABDE315	314 - 319	-	20 x 2,5	200

AB-DP Z / AB-DP G Abrazadera desagüe con pie

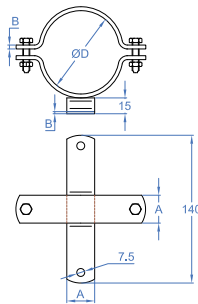

AB-DP Z / AB-DP G Zincada / Galvanizada

CÓDIGO	ØD(MM)	ØD(ʹ)	A X B	CARGA MÁXIMA
ABDP075	75 - 80	2 1/2ʹ	20 x 2	200
ABDP090	87 - 92	3ʹ	20 x 2	200
ABDP110	107 - 112	-	20 x 2	200
ABDP125	125 - 130	4 1/2ʹ	20 x 2	200
ABDP160	159 - 166	6ʹ	20 x 2	200
ABDP200	199 - 212	-	20 x 2	200
ABDP250	245 - 254	-	20 x 2	200

AB-ZI

Abarcón

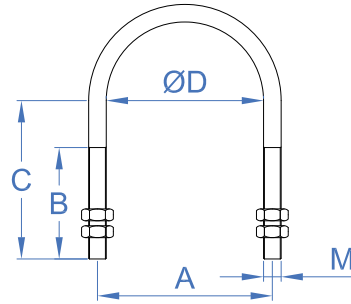

AB-ZI

Cincada

CÓDIGO	ØD(")	MÉTRICA	AXBXC	CARGA MÁXIMA
AZIM060250	1/4"	M6	20 / 14 / 20	250
AZIM060375	3/8"	M6	23,5 / 15 / 23	250
AZIM060500	1/2"	M6	27,5 / 17 / 25	250
AZIM060750	3/4"	M6	33 / 19 / 31	250
AZIM061000	1"	M6	39,5 / 24 / 39	250
AZIM061250	1 1/4"	M6	48,5 / 24 / 44	250
AZIM081500	1 1/2"	M8	56,5 / 26 / 48	350
AZIM082000	2"	M8	68,5 / 26 / 53	350
AZIM082250	2 1/4"	M8	83 / 35 / 63	350
AZIM082500	2 1/2"	M8	83 / 35 / 71	350
AZIM083000	3"	M8	99 / 35 / 76	350
AZIM083500	3 1/2"	M8	112 / 35 / 82	350
AZIM084000	4"	M8	125 / 35 / 87	350
AZIM084500	4 1/2"	M8	140 / 40 / 100	350
AZIM085000	5"	M8	152 / 40 / 105	350
AZIM086000	6"	M8	179 / 40 / 118	350
AZIM103000	3"	M10	100 / 45 / 66	350
AZIM103500	3 1/2"	M10	110 / 50 / 94	350
AZIM104000	4'	M10	125 / 55 / 97,5	350
AZIM105000	5'	M10	150 / 55 / 108	350
AZIM106000	6'	M10	170 / 55 / 125	350
AZIM108000	8'	M10	230 / 55 / 148	350

AB-SA

Soporte de abarcón

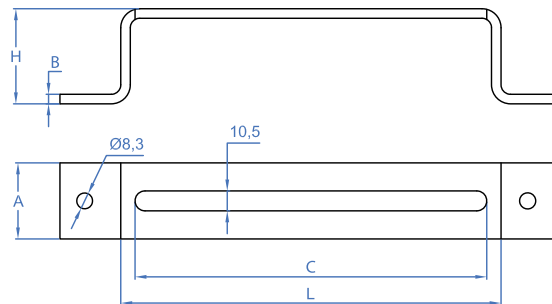

AB-SA

Soporte de abarcón

CÓDIGO	L	H	AXB	C
ABSA050100	100	50	40 x 5	85
ABSA050125	125	50	40 x 5	110
ABSA050200	200	50	40 x 5	185
ABSA050300	300	50	40 x 5	285
ABSA050400	400	50	40 x 5	385
ABSA050500	500	50	40 x 5	485
ABSA050600	600	50	40 x 5	585
ABSA100100	100	100	40 x 5	85
ABSA100125	125	100	40 x 5	110
ABSA100200	200	100	40 x 5	185
ABSA100300	300	100	40 x 5	285
ABSA100400	400	100	40 x 5	385
ABSA100500	500	100	40 x 6	485

AB-GP

Abrazadera de gran presión

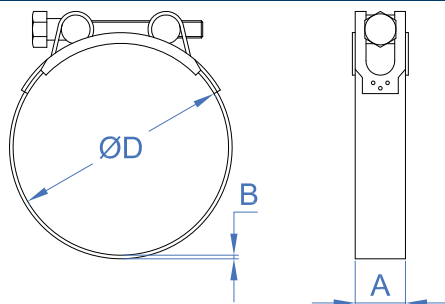

AB-GP

Abrazadera de gran presión

CÓDIGO	MXL	ØD(MM)	A X B
AGP023025	M5 x 35	23 - 25	18 X 0,6
AGP026028	M5 x 35	26 - 28	18 X 0,6
AGP029031	M5 x 35	29 - 31	18 X 0,6
AGP032035	M6 x 50	32 - 35	20 X 1
AGP036039	M6 x 50	36 - 39	20 X 1
AGP040043	M6 x 50	40 - 43	20 X 1
AGP044047	M6 x 50	44 - 47	20 X 1
AGP048051	M6 x 50	48 - 51	20 X 1
AGP052055	M6 x 50	52 - 55	20 X 1
AGP056059	M6 x 55	56 - 59	20 X 1
AGP060063	M6 x 55	60 - 63	20 X 1
AGP064067	M8 x 70	64 - 67	25 X 1,5
AGP068073	M8 x 70	68 - 73	25 X 1,5
AGP074079	M8 x 70	74 - 79	25 X 1,5
AGP080085	M8 x 70	80 - 85	25 X 1,5
AGP086091	M8 x 70	86 - 91	25 X 1,5
AGP092097	M8 x 70	92 - 97	25 X 1,5
AGP098103	M8 x 70	98 - 103	25 X 1,5
AGP104112	M8 x 80	104 - 112	25 X 1,5
AGP113121	M8 x 80	113 - 121	25 X 1,5
AGP122130	M8 x 80	122 - 130	25 X 1,5
AGP131139	M8 x 80	131 - 139	25 X 1,5
AGP140148	M8 x 80	140 - 148	25 X 1,5
AGP149161	M8 x 80	149 - 161	25 X 1,8
AGP162174	M8 x 80	162 - 174	25 X 1,8
AGP175187	M10 x 110	175-187	25 X 1,8
AGP188200	M10 x 110	188-200	25 X 1,8
AGP201213	M10 x 110	201-213	25 X 1,8
AGP214226	M10 x 110	214-226	25 X 1,8

AB-M6

Abrazadera M6

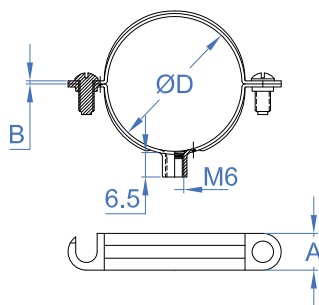

AB-M6 Z / AB-M6 Cincada

CÓDIGO	ØD(MM)	ØD(")	A X B	CARGA MÁXIMA
ABM6008 / ABMZ6008	8	-	10 x 1	70
ABM6010 / ABMZ6010	10	1/8"	10 x 1	70
ABM6012 / ABMZ6012	12	-	10 x 1	70
ABM6014 / ABMZ6014	14	1/4"	10 x 1	70
ABM6015 / ABMZ6015	15	-	10 x 1	70
ABM6016 / ABMZ6016	16	-	10 x 1	70
ABM6018 / ABMZ6018	18	3/8"	10 x 1	70
ABM6020 / ABMZ6020	20	-	10 x 1	70

CÓDIGO	ØD(MM)	ØD(")	A X B	CARGA MÁXIMA
ABM6022 / ABMZ6022	22	1/2"	10 x 1	70
ABM6025 / ABMZ6025	25	-	10 x 1	70
ABM6026 / ABMZ6026	26	3/4"	10 x 1	70
ABM6028 / ABMZ6028	28	-	10 x 1	70
ABM6032 / ABMZ6032	32	1"	10 x 1	70
ABM6035 / ABMZ6035	35	-	12 x 1,2	70
ABM6037 / ABMZ6037	37	-	12 x 1,2	100
ABM6040 / ABMZ6040	40	-	12 x 1,2	100
ABM6042 / ABMZ6042	42	1 1/4"	12 x 1,2	100
ABM6047 / ABMZ6047	47	1 1/2"	12 x 1,2	100
ABM6050 / ABMZ6050	50	-	12 x 1,2	100
ABM6054 / ABMZ6054	54	-	12 x 1,2	100
ABM6060 / ABMZ6060	60	2"	12 x 1,2	100
ABM6063 / ABMZ6063	63	-	12 x 1,2	100

AB-M6 A2

Abrazadera M6

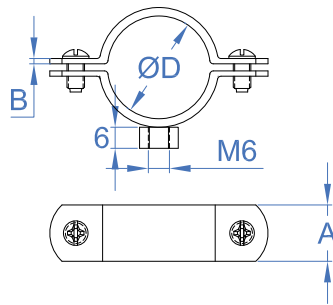

AB-M6 A2

Inoxidable A2

CÓDIGO	ØD(MM)	ØD(")	A X B	CARGA MÁXIMA
ABM6A2012	12	1/4"	16 x 1,5	70
ABM6A2015	14 - 15	-	16 x 1,5	70
ABM6A2018	16 - 18	3/8"	16 x 1,5	70
ABM6A2020	19 - 21	1/2"	16 x 1,5	70
ABM6A2022	22 - 24	-	16 x 1,5	70
ABM6A2028	25 - 30	3/4"	16 x 1,5	70

AB-D6

Abrazadera doble M6

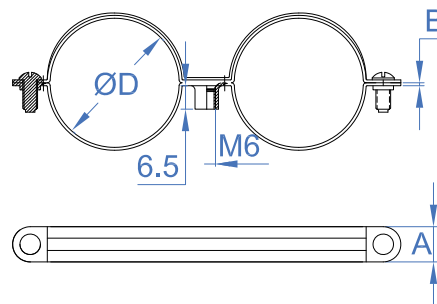

AB-D6 Z / AB-D6

Cincada

CÓDIGO	ØD(MM)	ØD(")	A X B	CARGA MÁXIMA
ABD6012 / ABDZ6012	12	1/8"	12 x 1	100
ABD6015 / ABDZ6015	15	1/4"	12 x 1,2	100
ABD6018 / ABDZ6018	18	3/8"	12 x 1,2	100
ABD6022 / ABDZ6022	22	1/2"	12 x 1,2	100
ABD6028 / ABDZ6028	28	3/4"	12 x 1,2	100

AB-6I

Abrazadera isofónica M6

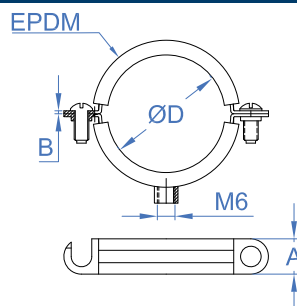

AB-6I

Abrazadera isofónica M6

CÓDIGO	ØD(MM)	ØD(")	A X B	CARGA MÁXIMA
AB6I012	12	1/8"	15 x 1,2	70
AB6I015	15	1/4"	15 x 1,2	70
AB6I016	16	-	15 x 1,2	70
AB6I018	18	3/8"	15 x 1,2	70
AB6I022	22	1/2"	15 x 1,2	70
AB6I026	26	-	15 x 1,2	70
AB6I028	28	3/4"	15 x 1,2	70
AB6I032	32	-	15 x 1,2	70
AB6I035	35	1"	15 x 1,2	70
AB6I042	42	1 1/4"	15 x 1,2	100
AB6I048	48	1 1/2"	15 x 1,2	100
AB6I054	54	-	15 x 1,2	100
AB6I060	60	2"	15 x 1,2	100

AB-DI

Abrazadera doble isofónica M6

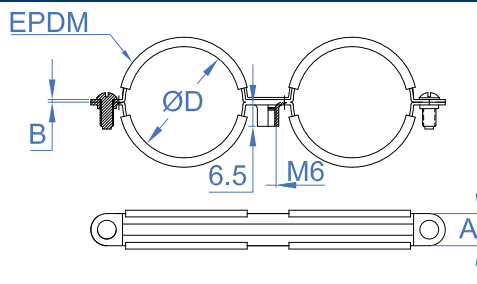

AB-DI

Abrazadera M6. Bicromatada

CÓDIGO	ØD(MM)	ØD(")	A X B	CARGA MÁXIMA
ABDI0012	12	1/8"	15 x 1	100
ABDI0015	15	1/4"	15 x 1,2	100
ABDI0018	18	3/8"	15 x 1,2	100
ABDI0022	22	1/2"	15 x 1,2	100
ABDI0028	28	3/4"	15 x 1,2	100

AB-M7 Z

Abrazadera M6

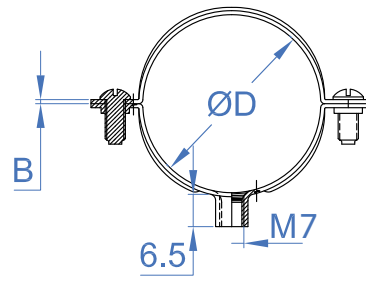

AB-M7 Z

Cincada

CÓDIGO	ØD(MM)	ØD(")	A X B	CARGA MÁXIMA
ABMZ7008	8	-	11 X 1	-
ABMZ7010	10	1/8"	11 X 1	-
ABMZ7012	12	-	11 X 1	-
ABMZ7014	14	1/4"	11 X 1	-
ABMZ7016	16	-	11 X 1	-
ABMZ7018	18	3/8"	11 X 1	-
ABMZ7020	20	-	11 X 1	-
ABMZ7022	22	1/2"	11 X 1	-
ABMZ7024	24	-	11 X 1	-
ABMZ7025	25	-	11 X 1	-
ABMZ7026	26	3/4"	11 X 1	-
ABMZ7028	28	-	11 X 1	-
ABMZ7032	32	1"	11 X 1	-
ABMZ7034	34	-	11 X 1	-
ABMZ7036	36	-	11 X 1	-
ABMZ7038	38	-	11 X 1	-
ABMZ7040	40	-	11 X 1	-
ABMZ7050	50	-	11 X 1	-
ABMZ7063	63	-	12 X 1,2	-

AB-D7 Z

Abrazadera doble M6

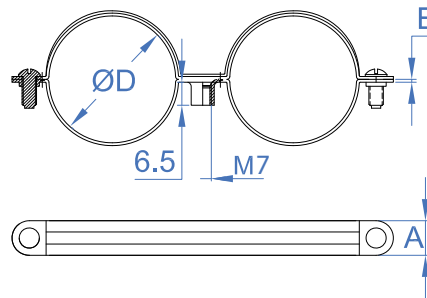

AB-D7 Z

Cincada

CÓDIGO	ØD(MM)	ØD(")	A X B	CARGA MÁXIMA
ABDZ70810	8-10	-	11 X 1	-
ABDZ71012	10-12	1/8"	11 X 1	-
ABDZ71214	12-14	-	11 X 1	-
ABDZ71416	14-16	-	11 X 1	-
ABDZ71618	16-18	3/8"	11 X 1	-
ABDZ71820	18-20	-	11 X 1	-
ABDZ72022	20-22	1/2"	11 X 1	-
ABDZ72224	22-24	-	11 X 1	-
ABDZ72628	26-28	3/4"	11 X 1	-

AB-7I Z

Abrazadera isofónica M6

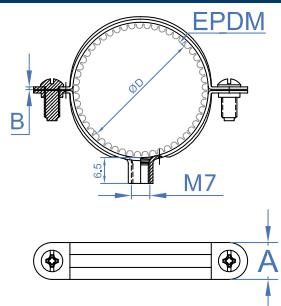

AB-7I Z

Abrazadera isofónica M6

CÓDIGO	ØD(MM)	ØD(")	A X B	CARGA MÁXIMA
AB7IZ010	10	-	11 X 1	-
AB7IZ012	12	-	11 X 1	-
AB7IZ014	14	-	11 X 1	-
AB7IZ016	16	-	11 X 1	-
AB7IZ018	18	-	11 X 1	-
AB7IZ020	20	-	11 X 1	-
AB7IZ022	22	-	11 X 1	-
AB7IZ024	24	-	11 X 1	-
AB7IZ026	26	-	11 X 1	-
AB7IZ028	28	-	11 X 1	-
AB7IZ032	32	-	11 X 1	-
AB7IZ034	34	-	11 X 1	-
AB7IZ036	36	-	12 X 1	-
AB7IZ038	38	-	12 X 1	-
AB7IZ040	40	-	12 X 1	-
AB7IZ050	50	-	12 X 1,2	-

AB-7ID Z

Abrazadera doble isofónica M6

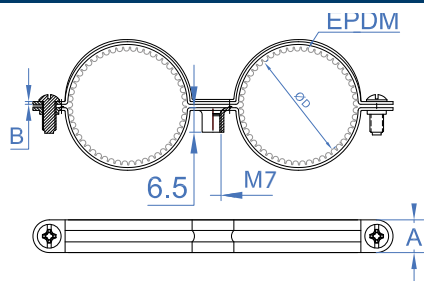

AB-7ID Z

Abrazadera M6. Bicromatada

CÓDIGO	ØD(MM)	ØD(")	A X B	CARGA MÁXIMA
AB7IDZ0810	08-10	1/8"	11 X 1	-
AB7IDZ1012	10-12	1/8"	11 X 1	-
AB7IDZ1214	12-14	1/4"	11 X 1	-
AB7IDZ1416	14-16	1/4"	11 X 1	-
AB7IDZ1618	16-18	3/8"	11 X 1	-
AB7IDZ1820	18-20	3/8"	11 X 1	-
AB7IDZ2022	20-22	1/2"	11 X 1	-
AB7IDZ2224	22-24	1/2"	11 X 1	-
AB7IDZ2628	26-28	3/4"	11 X 1	-

AB-PI

Grapa 1 pie

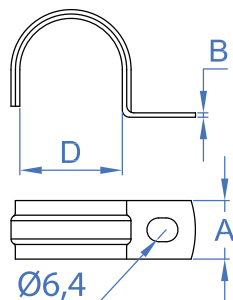

AB-PI

Abrazadera de un pie

CÓDIGO	ØD(MM)	ØD(")	A X B	CARGA MÁXIMA
ABPI006	6	-	12 x 1	30
ABPI008	8	-	12 x 1	30
ABPI010	10	1/8"	12 x 1	30
ABPI012	12	-	12 x 1	30
ABPI014	14	1/4"	15 x 1	30
ABPI016	16	-	15 x 1	30
ABPI018	18	3/8"	15 x 1	30
ABPI020	20	-	15 x 1	30
ABPI022	22	1/2"	15 x 1,2	30
ABPI025	25	-	15 x 1,2	30
ABPI026	26	3/4"	15 x 1,2	30
ABPI028	28	-	15 x 1,2	30
ABPI032	32	1"	15 x 1,2	30
ABPI040	40	-	15 x 1,2	30
ABPI042	42	1 1/4"	15 x 1,2	30
ABPI047	47	1 1/2"	15 x 1,2	30
ABPI050	50	-	15 x 1,2	30
ABPI063	63	2"	15 x 1,2	30

AB-PU

Grapa puente

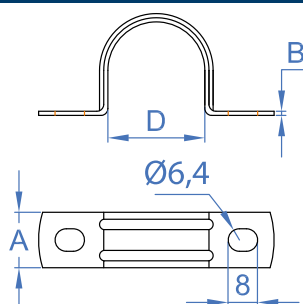

AB-PU

Abrazadera grapa puente

CÓDIGO	ØD(MM)	ØD(")	A X B	CARGA MÁXIMA
ABPU016	16	-	12 x 1,2	75
ABPU018	18	3/8"	12 x 1,2	75
ABPU020	20	-	12 x 1,2	75
ABPU022	22	1/2"	15 x 1,2	75
ABPU025	25	-	15 x 1,2	75
ABPU028	28	3/4"	15 x 1,2	75
ABPU032	32	1"	15 x 1,2	75
ABPU037	37	-	18 x 1,2	75
ABPU040	40	1 1/4"	18 x 1,2	75
ABPU050	50	1 1/2"	18 x 1,2	75
ABPU063	63	2"	18 x 1,2	75

AB-IP

Grapa puente isofónica para montaje

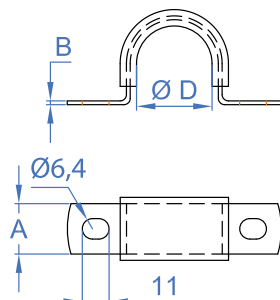

AB-IP

Abrazadera puente isofónica para montaje

CÓDIGO	ØD(MM)	ØD(")	A X B
ABIP015	15	1/4"	20 x 1,5
ABIP018	18	3/8"	20 x 1,5
ABIP022	22	1/2"	20 x 1,5
ABIP026	26	3/4"	20 x 1,5
ABIP028	28	-	20 x 1,5
ABIP035	35	1"	20 x 1,5
ABIP042	42	1 1/4"	20 x 1,5
ABIP048	48	1 1/2"	20 x 1,5
ABIP054	54	-	20 x 1,5
ABIP060	60	2"	20 x 1,5
ABIP067	67	-	20 x 1,5
ABIP075	75	2 1/2"	20 x 1,5
ABIP090	90	3"	20 x 1,5

AB-SI

Soporte para grapa puente isofónica

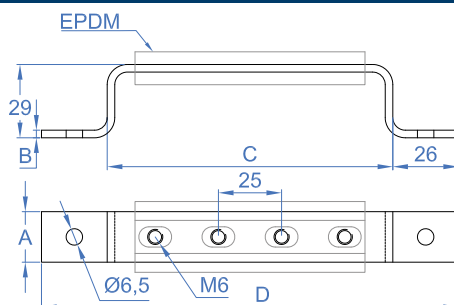

AB-SI

Soporte para grapa puente isofónica

CÓDIGO	A X B	C	D	Nº AGUJEROS
ABSI003	20 x 3	88	140	3
ABSI004	20 x 3	113	165	4
ABSI005	20 x 3	138	190	5
ABSI006	20 x 3	163	215	6
ABSI007	20 x 3	188	240	7
ABSI008	20 x 3	213	265	8
ABSI009	20 x 3	238	290	9
ABSI010	20 x 3	263	315	10
ABSI011	20 x 3	288	340	11
ABSI012	20 x 3	313	365	12
ABSI013	20 x 3	338	390	13
ABSI014	20 x 3	363	415	14
ABSI015	20 x 3	388	440	15
ABSI016	20 x 3	413	465	16
ABSI017	20 x 3	438	490	17
ABSI018	20 x 3	463	515	18
ABSI019	20 x 3	488	540	19
ABSI020	20 x 3	513	565	20
ABSI021	20 x 3	538	590	21
ABSI022	20 x 3	563	615	22
ABSI025	20 x 3	638	690	25

AB-SF

Abrazadera sin fin

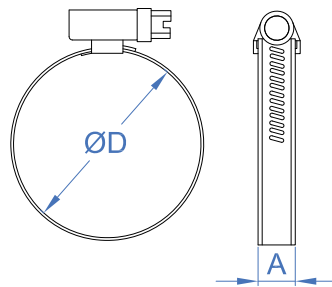

AB-SF

Cincada

CÓDIGO	ØD(MM)	ØD(")	AXB	PAR DE APRIETE
ASF008016	8-16	5/16" - 5/8"	9 x 0,7	4,5
ASF012022	12-22	1/2" - 7/8"	9 x 0,7	4,5
ASF016027	16 - 27	5/8" - 1 1/16"	9 x 0,7	4,5
ASF020032	20 - 32	3/4" - 1 1/4"	9 x 0,7	4,5
ASF025040	25 - 40	1" - 1 5/8"	9 x 0,7	4,5
ASF030045	30 - 45	1 3/16" - 1 3/4"	9 x 0,8	4,5
ASF035050	35 - 50	1 3/8" - 2"	9 x 0,8	4,5
ASF040060	40 - 60	1 5/8" - 2 3/8"	9 x 0,8	4,5
ASF050070	50 - 70	2" - 2 3/4"	9 x 0,8	4,5
ASF060080	60 - 80	2 3/8" - 3 1/8"	9 x 0,8	4,5
ASF070090	70 - 90	2 3/4" - 3 1/2"	9 x 0,8	4,5
ASF080100	80 - 100	3 1/8" - 4"	9 x 0,8	4,5
ASF090110	90 - 110	3 1/2" - 4 3/8"	9 x 0,8	4,5
ASF100120	100 - 120	4" - 4 3/4"	9 x 0,8	4,5
ASF110130	110 - 130	4 3/8" - 5 1/8"	9 x 0,8	4,5
ASF120140	120 - 140	4 3/4" - 5 1/2"	9 x 0,8	4,5
ASF130150	130 - 150	5 1/8" - 5 7/8"	9 x 0,8	4,5

AB-SF A2

Inoxidable A2

CÓDIGO	ØD(MM)	ØD(")	AXB	PAR DE APRIETE
ASF2010016	10-16	5/16" - 5/8"	9 x 0,7	4
ASF2012020	12-20	1/2" - 7/8"	9 x 0,7	4
ASF2016027	16 - 27	5/8" - 1 1/16"	9 x 0,7	4
ASF2020032	20 - 32	3/4" - 1 1/4"	9 x 0,7	4
ASF2025040	25 - 40	1" - 1 5/8"	9 x 0,7	4
ASF2032050	32 - 50	1 3/8" - 2"	9 x 0,7	4
ASF2040060	40 - 60	1 5/8" - 2 3/8"	9 x 0,7	4
ASF2050070	50 - 70	2" - 2 3/4"	9 x 0,7	4
ASF2060080	60 - 80	2 3/8" - 3 1/8"	9 x 0,7	4
ASF2070090	70 - 90	2 3/4" - 3 1/2"	9 x 0,7	4
ASF2080100	80 - 100	3 1/8" - 4"	9 x 0,7	4
ASF2090110	90 - 110	3 1/2" - 4 3/8"	9 x 0,7	4
ASF2100120	100 - 120	4" - 4 3/4"	9 x 0,7	4
ASF2110130	110 - 130	4 3/8" - 5 1/8"	9 x 0,7	4
ASF2120140	120 - 140	4 3/4" - 5 1/2"	9 x 0,7	4
ASF2130150	130 - 150	5 1/8" - 5 7/8"	9 x 0,7	4

CI-PE

Cinta perforada

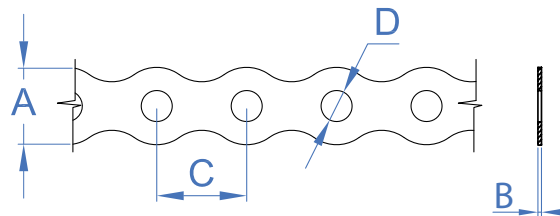

CI-PE

Cinta perforada curva. ATLANTIS C2-M

CÓDIGO	AXB	c	D
CIPE1208	12 x 0,8	14	5
CIPE1708	17 x 0,8	20	7

CI-PE A2

Cinta perforada curva. Inoxidable A2

CÓDIGO	AXB	c	D
CIPEA21708	17 x 0,8	20	7

CI-PR

Cinta perforada recta ATLANTIS C2-M

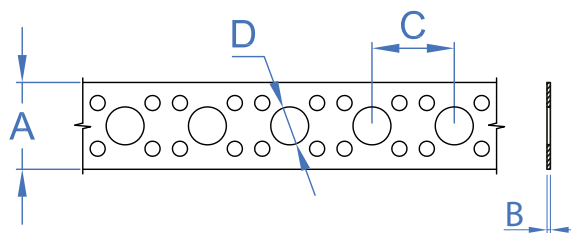

CI-PR

Cinta perforada recta ATLANTIS C2-M

CÓDIGO	A X B	c	D
CIPR1908	19 x 0,8	18	8,3
CIPR1208	12 x 0,8	12	6,2

AB-CR

Abrazadera cromada M6

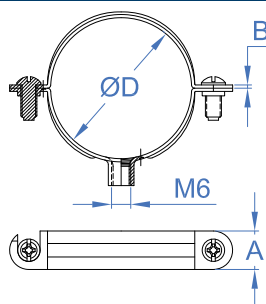

AB-CR

Abrazadera cromada M6

CÓDIGO	ØD(MM)	ØD(")	A X B	CARGA MÁXIMA
ABCR010	10	1/8"	12 x 1,2	70
ABCR012	12	1/4"	12 x 1,2	70

AB-BU

Abrazadera butano

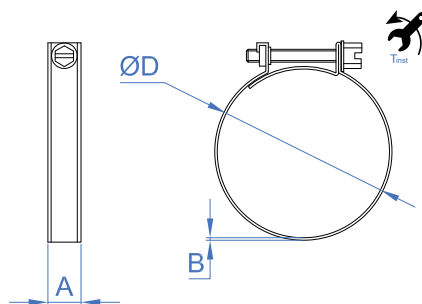

AB-BU

Abrazadera butano

CÓDIGO	ØD(MM)	ØD(")	A X B	PAR DE APRIETE
ABBU1315	13-15	1/2" - 9/16"	9 x 0,6	2
ABBU1618	16-18	5/8" - 11/16"	9 x 0,6	2
ABBU1921	19-21	3/4" - 13/16"	9 x 0,6	2

AB-GM

Abrazadera gásmica con tirafondo amarilla

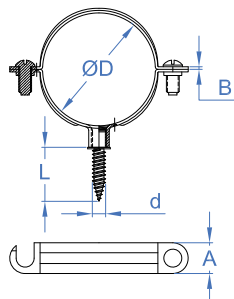

AB-GM

Abrazadera gásmica amarilla M6 con tirafondo

CÓDIGO	ØD(MM)	ØD(")	A X B	CARGA MÁXIMA
ABGM012	12	1/8"	12 x 1,2	70
ABGM015	15	1/4"	12 x 1,2	70
ABGM018	18	3/8"	12 x 1,2	70
ABGM022	22	1/2"	12 x 1,2	70
ABGM028	28	3/4"	12 x 1,2	70
ABGM035	35	1"	12 x 1,2	70

AB-GS

Abrazadera gásmica negra M6 con tirafondo

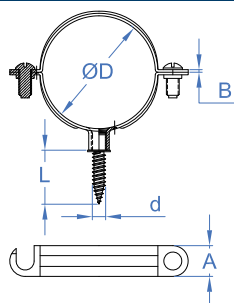

AB-GS

Abrazadera gásmica negra M6 con tirafondo

CÓDIGO	ØD(MM)	ØD(")	A X B	CARGA MÁXIMA
ABGS010	10	1/8"	12 x 1,2	70
ABGS012	12	-	12 x 1,2	70
ABGS015	15	1/4"	12 x 1,2	70
ABGS018	18	3/8"	12 x 1,2	70
ABGS022	22	1/2"	12 x 1,2	70
ABGS028	28	3/4"	12 x 1,2	70
ABGS035	35	1"	12 x 1,2	70
ABGS042	42	1 1/4"	12 x 1,2	70
ABGS054	54	-	12 x 1,2	70

AB-GD

Abrazadera gásmica negra doble M6 con tirafondo

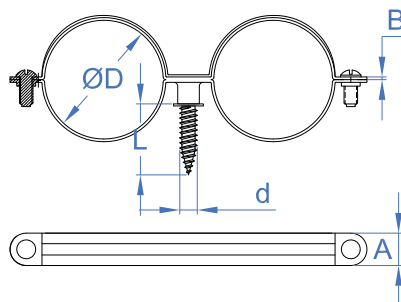

AB-GD

Abrazadera gásmica negra doble M6 con tirafondo

CÓDIGO	ØD(MM)	ØD(")	A X B	CARGA MÁXIMA
ABGD012	12	1/8"	12 x 1,2	100
ABGD015	15	1/4"	12 x 1,2	100
ABGD018	18	3/8"	12 x 1,2	100
ABGD022	22	1/2"	12 x 1,2	100
ABGD028	28	3/4"	12 x 1,2	100

AB-PE

Abrazadera colgante pera

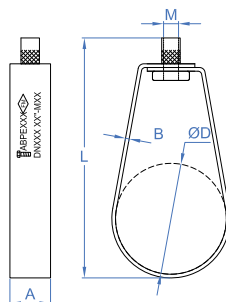

AB-PE

Abrazadera colgante pera

CÓDIGO	ØD(MM)	ØD('')	A X B	LONGITUD	MEDIDA TORNILLO	CARGA MÁXIMA
ABPE028	DN 20	3/4"	21 x 1	72	M10 (3/8")	154
ABPE035	DN 25	1"	21 x 1	78	M10 (3/8")	186
ABPE040	DN 32	1 1/4"	21 x 1	88	M10 (3/8")	195
ABPE048	DN 40	1 1/2"	21 x 1,2	95	M10 (3/8")	236
ABPE060	DN 50	2"	21 x 1,2	105	M10 (3/8")	288
ABPE075	DN 65	2 1/2"	21 x 1,2	125	M10 (3/8")	426
ABPE090	DN 80	3"	21 x 1,2	140	M10 (3/8")	481
ABPE100	DN 90	3 1/2"	21 x 1,2	160	M10 (3/8")	569
ABPE115	DN 100	4"	21 x 2	173	M10 (3/8")	669
ABPE140	DN 125	5"	30 x 2	209	M12 (1/2")	907
ABPE160	DN 150	6"	30 x 2,5	249	M12 (1/2")	1186
ABPE220	DN 200	8"	35 x 2,5	309	M12 (1/2")	1723

AB-CH

Abrazadera desagüe M8

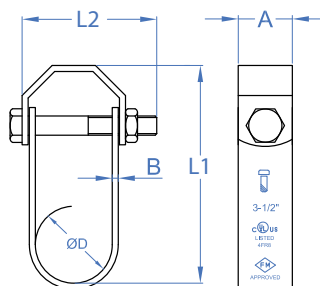

AB-CH

Abrazadera desagüe M8

CÓDIGO	ØD(MM)	ØD('')	A X B	L1	L2	CARGA MÁXIMA
ABCH00034	28	3/4"	22,5 x 2,5	82,5	50	-
ABCH01000	35	1"	22,5 x 2,5	99	57	-
ABCH01014	42	1 1/4"	22,5 x 2,5	106	70	-
ABCH01012	48	1 1/2"	22,5 x 2,5	107	75	-
ABCH02000	60	2"	25,5 x 2,5	126	90	-
ABCH02012	75	2 1/2"	26,0 x 3,0	156	110	-
ABCH03000	90	3"	26,0 x 3,0	169	115	-
ABCH04000	115	4"	30,0 x 4,0	200	15	-
ABCH05000	140	5"	32,0 x 4,5	231	200	-
ABCH06000	160	6"	36,5 x 4,5	260	225	-
ABCH08000	220	8"	42,5 x 4,5	329	280	-
ABCH10000	275	10"	44,5 x 6,0	381	360	-
ABCH12000	325	12"	50,0 x 6,0	457	410	-
ABCH14000	355	14"	50,0 x 6,0	514	465	-
ABCH16000	405	16"	64,0 x 6,0	560	520	-

AB-IN

Clip simple de polipropileno con casquillo de latón M6

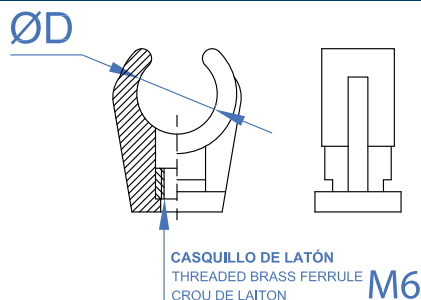

AB-IN

Clip simple de polipropileno con casquillo de latón M6

CÓDIGO	ØD(MM)	ØD(")	VÁLIDO PARA	CARGA MÁXIMA
ABIN012	12	1/4"	Carril 20/10	-
ABIN014	14-15	3/8"	Carril 20/10	-
ABIN016	16-18	-	Carril 20/10	-
ABIN020	20-22	-	Carril 20/10	-
ABIN025	25	-	Carril 20/10	-
ABIN028	28	3/4"	Carril 20/10	-
ABIN032	32	-	Carril 20/10	-
ABIN035	35	-	Carril 20/10	-

AB-ID

Clip doble de polipropileno con casquillo de latón M6

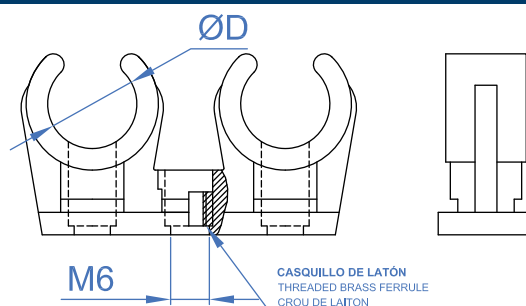

AB-ID

Clip doble de nylon (poliamida 6.6) con casquillo de latón M6

CÓDIGO	ØD(MM)	ØD(")	VÁLIDO PARA	CARGA MÁXIMA
ABID012	12	1/4"	Carril 20/10	-
ABID014	14-15	3/8"	Carril 20/10	-
ABID016	16-18	-	Carril 20/10	-
ABID020	20-22	-	Carril 20/10	-
ABID028	28	3/4"	Carril 20/10	-

AB-GU

Abrazadera guía simple con pre-rosca M6

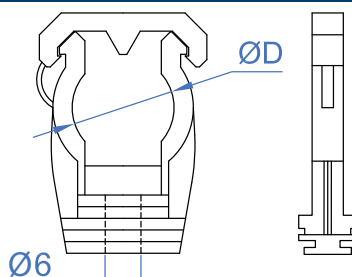

AB-GU

Abrazadera guía gris simple con pre-rosca M6

CÓDIGO	ØD(MM)	ØD(")	VÁLIDO PARA	CARGA MÁXIMA
ABGUG12	12	1/4"	20/10 27/18 28/30	-
ABGUG15	15	3/8"	20/10 27/18 28/30	-
ABGUG18	18	-	20/10 27/18 28/30	-
ABGUG20	20	-	20/10 27/18 28/30	-
ABGUG22	22	1/2"	20/10 27/18 28/30	-
ABGUG25	25	-	20/10 27/18 28/30	-
ABGUG28	28	-	20/10 27/18 28/30	-
ABGUG32	32	1"	20/10 27/18 28/30	-
ABGUG40	40	-	20/10 27/18 28/30	-
ABGUG50	50	-	20/10 27/18 28/30	-

AB-MUG

Abrazadera multidímetro

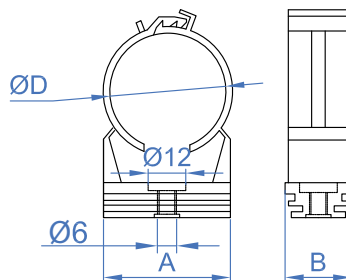

AB-MUG

Abrazadera multiusos

CÓDIGO	ØD(MM)	Ød(*)	A X B	VÁLIDO PARA	CARGA MÁXIMA
ABMUG12	12	-	17 x 20	20/10 27/18 28/30	-
ABMUG15	15	-	21 x 20	20/10 27/18 28/30	-
ABMUG18	18	-	25 x 20	20/10 27/18 28/30	-
ABMUG22	22	-	30 x 20	20/10 27/18 28/30	-
ABMUG26	26	-	33 x 20	20/10 27/18 28/30	-
ABMUG32	32	-	38 x 20	20/10 27/18 28/30	-
ABMUG40	40	-	46 x 20	20/10 27/18 28/30	-
ABMUG48	42	-	56 x 20	20/10 27/18 28/30	-

AB-PR

Abrazadera a presión con pre-roscas M6

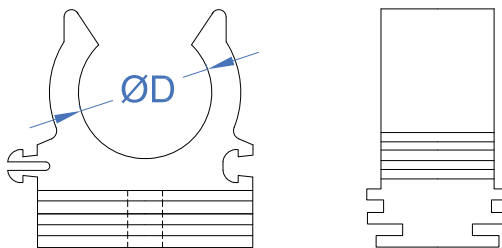

AB-PR

Gris

CÓDIGO	ØD(MM)	Ød(*)	VÁLIDO PARA	CARGA MÁXIMA
ABPRG12	12	1/4"	20/10 27/18 28/30	-
ABPRG15	15-18	3/8"	20/10 27/18 28/30	-
ABPRG20	20-22	-	20/10 27/18 28/30	-
ABPRG25	25-28	1/2"	20/10 27/18 28/30	-
ABPRG32	32-35	-	20/10 27/18 28/30	-
ABPRG40	40	-	20/10 27/18 28/30	-
ABPRG50	50	3/4"	20/10 27/18 28/30	-

AB-MS

Abrazadera multitubo + taco. Simple

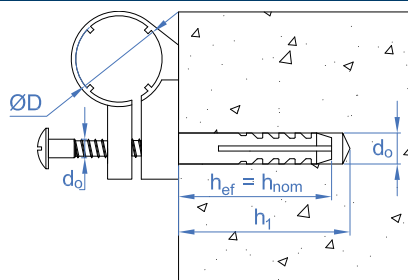

AB-MS

Abrazadera multitubo + taco. Simple

CÓDIGO	ØD(MM)	Ø BROCA	PROFUNDIDAD MÍN. DE TALADRO	PROFUNDIDAD MIN. DEL#ANCLAJE	EXTRACCIÓN#HORMIGÓN NO-FISURADO	EXTRACCIÓN#LADRILLO HUECO	MEDIDA TORNILLO
ABMS10	10	5	30	20	9	5	3,5x35
ABMS12	12	5	30	20	9	5	3,5x35
ABMS14	14	6	35	25	15	8	4x45
ABMS16	16	6	35	25	15	8	4x45
ABMS18	18	8	45	30	16	12	4,5x50
ABMS20	20	8	45	30	16	12	4,5x50
ABMS22	22	8	45	30	16	12	4,5x50
ABMS26	26	10	50	40	30	15	6x60
ABMS28	28	10	50	40	30	15	6,5x60

AB-MD

Abrazadera multitubo + taco. Doble

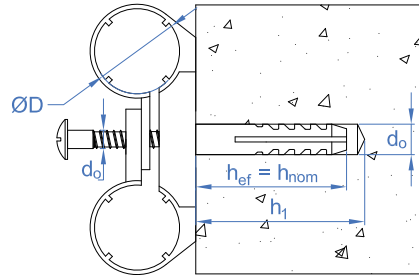

AB-MD

Abrazadera multitubo + taco. Doble

CÓDIGO	ØD(MM)	Ø BROCA	PROFUNDIDAD MÍN. DE TALADRO	PROFUNDIDAD MIN. DEL ANCLAJE	EXTRACCIÓN HORMIGÓN NO-FISURADO	EXTRACCIÓN LADRILLO HUECO	MEDIDA TORNILLO
ABMD10	10	8	60	30	16	12	4,5x50
ABMD12	12	8	60	30	16	12	4,5x50
ABMD14	14	8	60	30	16	12	4,5x50
ABMD16	16	8	60	30	16	12	4,5x50
ABMD18	18	10	70	40	30	15	6x60
ABMD20	20	10	70	40	30	15	6x60
ABMD22	22	10	70	40	30	15	6x60
ABMD26	26	10	70	40	30	15	6x60
ABMD28	28	10	70	40	30	15	6x60

AB-T

Taco para fijación de tubo INDEXring

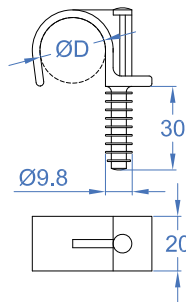

AB-TS

Simple

CÓDIGO	ØD(MM)	ØD(")	CARGA MÁXIMA
ABTS014	14 - 15	-	-
ABTS016	16 - 17	3/8"	-
ABTS018	18 - 19	-	-
ABTS020	20 - 21	1/2"	-
ABTS022	22 - 23	-	-
ABTS025	25 - 26	3/4"	-
ABTS028	28 - 29	-	-
ABTS032	30 - 32	-	-

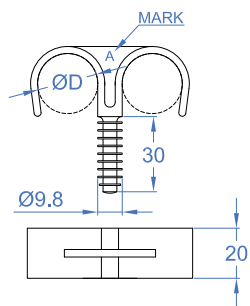

AB-TD

Doble

CÓDIGO	ØD(MM)	ØD('')	CARGA MÁXIMA
ABTD016	15 - 16	3/8"	-
ABTD018	18 - 19	-	-
ABTD020	20 - 21	1/2"	-
ABTD022	22 - 23	-	-
ABTD025	25 - 26	3/4"	-
ABTD028	28 - 29	-	-

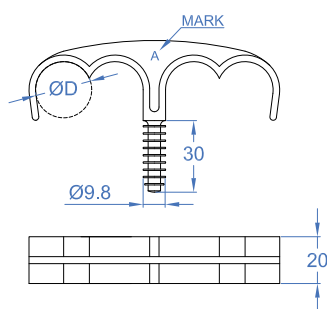

AB-TC

Cuádruple

CÓDIGO	ØD(MM)	ØD('')	CARGA MÁXIMA
ABTC020	20 - 21	1/2"	-
ABTC025	25 - 26	3/4"	-

GAMA DE ELEMENTOS DE SOPORTACIÓN

CÓDIGO	DESCRIPCION	MATERIAL	RECUBRIMIENTO
GPZ201010	Carril 20 x 10 x 1	A	Z
GPZ250808	Carril 25 x 8 x 0,80		
GPG271812	Carril 27 x 18 x 1,25		
GPG283018	Carril 28 x 30 x 1,80		
GPG384020	Carril 38 x 40 x 2,00	A	Z
GPG351312	Carril 35 x 12 x 1,20		
GPG402015	Carril 40 x 20 x 1,50		
GPI271812	Carril 27 x 18 x 1,25	A2 INOX	
GPI283015	Carril 28 x 30 x 1,50	A	Z
GPP271812	Carril 27 x 18 x 1,25	A	Z
GPV251120	Carril 25 x 11 x 2,00	PVC	
GPO357510			
GPO351515	Guía Omega perforada/lisa cincada	A	Z
GLO357510			
GLO351515			
SPZ271820	Soporte 27 x 18 x 1,20 x 200		
SPZ271830	Soporte 27 x 18 x 1,20 x 300		
SPZ384020	Soporte 38 x 40 x 2,00 x 200		
SPZ384025	Soporte 38 x 40 x 2,00 x 250		
SPZ384030	Soporte 38 x 40 x 2,00 x 300	A	Z
SPZ384035	Soporte 38 x 40 x 2,00 x 350		
SPZ384040	Soporte 38 x 40 x 2,00 x 400		
SPZ384050	Soporte 38 x 40 x 2,00 x 500		
SPZ384060	Soporte 38 x 40 x 2,00 x 600		
SPV2718	Soporte vertical	A	Z
SPV3840			
SPH2718	Soporte horizontal	A	Z
SPH3840			
SPGH2718	Soporte horizontal carriles	A	Z
SPGH3840			
TG230620			
TG230820	Tope tornillo guía perforada	A	Z
TG230830			
TG340830			
TG41030			
TUG201006			
TUG201008	Tuerca guía perforada	A	Z
TUG271808			
TUG271810			
TUGRA2706			
TUGRA2708	Tuerca guía con arandela fijación rápida	A	Z
TUGRA3808			
TUGRA3810			
TGR230620			
TGR230820			
TGR230830	Tope-tornillo guía de fijación rápida	A	Z
TGR340830			
TGR341030			
EMZ45		A	Z
EMZ90			
EMZ00	Escuadras cincadas e inoxidables		
EMI45		A2 INOX	
EMI90			
EMIO0			
PGZ2718		A	Z
PGZ2830			
PGZ3840	Puente guía cincado e inoxidable		
PGI2718		A2 INOX	
PGI2830			
PGI3840			
PUZ2718	Placa de unión para perfiles	A	Z
PUZ3840			
SOTP2718			
SOTP2830			
SOTP3840	Tapón plástico para soportación	PLÁSTICO PURPURILE	
SOTP4121			
SOTP4141			
SOPG27			
SOPG38	Cubierta de goma para soportación	EPDM	
SOPG41			

CÓDIGO	DESCRIPCION	MATERIAL	RECUBRIMIENTO
GPX412115	Carril 41 x 21 x 1,50		
GPX412120	Carril 41 x 21 x 2,00		
GPX412125	Carril 41 x 21 x 2,50		
GPX414115	Carril 41 x 41 x 1,50	A	Z
GPX414120	Carril 41 x 41 x 2,00		
GPX414125	Carril 41 x 41 x 2,50		
GPX2M412120	Carril 41 x 21 x 2,00		
GPX2M414120	Carril 41 x 41 x 2,00		
SPX412115	Soporte 41 x 21 x 2,50 x 150		
SPX412130	Soporte 41 x 21 x 2,50 x 300		
SPX412145	Soporte 41 x 21 x 2,50 x 450		
SPX414115	Soporte 41 x 41 x 2,50 x 150		
SPX414130	Soporte 41 x 41 x 2,50 x 300	A	Z
SPX414145	Soporte 41 x 41 x 2,50 x 450		
SPX414160	Soporte 41 x 41 x 2,50 x 600		
SPX414175	Soporte 41 x 41 x 2,50 x 750		
SPX414110	Soporte 41 x 41 x 2,50 x 1000		
SPGH3840	Soporte horizontal	A	Z
PRX01	Soporte regulable para perfil INDESTRUT	A	Z
SPRXH4121	Soporte base rectangular U INDESTRUT	A	Z
SPRXV4121			
SPUX412100	Soporte base U INDESTRUT	A	Z
SPUX412145			
ABGX4121	Abrazadera guía perforada INDESTRUT	A	Z
EMPX4121	Empalme para perfiles INDESTRUT	A	Z
RESX300	Refuerzo soportes INDESTRUT	A	Z
RESX550			
RTX01	Soporte rotula INDESTRUT	A	Z
EMX9002			
EMX9004	Escuadras cincadas INDESTRUT	A	Z
EMX4502			
EMX1302			
PGX4121	Puente guía INDESTRUT	A	Z
PGX4141			
UNEX412103			
UNPX42101	Unión escuadra/placa T INDESTRUT	A	Z
UNPX42102			
UNPX42103			
UNPX42104			
UNTX412104			
SCRX090	Escuadra reforzada INDESTRUT	A	Z
TUGX08	Tuerca guía perforada	A	Z
TUGX10			
TUGXMU08	Tuerca guía con muelle INDESTRUT	A	Z
TUGXMU10			
TGX0840			
TGX0860	Tope-tornillo guía INDESTRUT	A	Z
TGX1040			
TGX1060			
TURX08	Tuerca fijación rápida INDESTRUT	A	Z
TURX10			
TURX12			
TURXA08	Tuerca INDESTRUT con arandela de fijación rápida	A	Z
TURXA10			
TGRX0830			
TGRX0860	Tope guía INDESTRUT de fijación rápida	A	Z
TGRX1030			
TGRX1060			
PAEXM08	Patín de expansion	A	Z
PAEXM10			
SOTP4121	Tapón plástico para soportación	PLÁSTICO PURPURILE	
SOTP4141			
SOPG41	Cubierta de goma para soportación	EPDM	

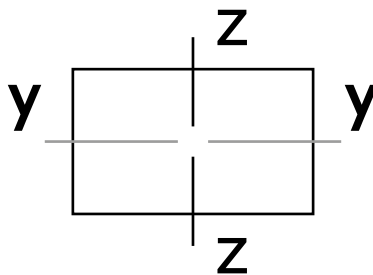
ASPECTOS GEOMÉTRICOS

CÓDIGO	SECCIÓN	PESO	ÁREA	MOMENTO INERCIA (I _y)	MOMENTO INERCIA (I _z)	MÓDULO RESISTENTE (W _y)	MÓDULO RESISTENTE (W _z)
	[mm x mm]	[Kg/m]	[cm ²]	[cm ⁴]	[cm ⁴]	[cm ³]	[cm ³]
GPZ201010	20 x 10	0.31	0.44	0.06	0.25	0.10	0.25
GPZ250808	25 x 8	0.26	0.35	0.03	0.30	0.06	0.24
GPG271812	27 x 18	0.66	0.84	0.37	0.97	0.34	0.71
GPG283018	28 x 30	1.25	1.60	1.79	2.10	1.03	1.50
GPG384020	38 x 40	2.00	2.55	5.39	6.18	2.39	3.25
GPG402015	40 x 20	0.94	1.30	0.71	3.10	0.57	1.55
GPP271812	27 x 18	0.66	0.84	0.37	0.97	0.34	0.71
GPI271812	27 x 18	0.66	0.79	0.36	0.90	0.33	0.67
GPI283015	28 x 30	1.25	1.37	1.54	1.82	0.89	1.30
GPX412115	41 x 21	1.21	1.41	0.89	3.58	0.70	1.75
GPX412120	41 x 21	1.55	1.99	0.95	4.44	0.75	2.17
GPX412125	41 x 21	1.71	2.28	1.32	5.54	1.03	2.70
GPX414115	41 X 41	1.65	2.42	4.88	5.99	2.05	2.92
GPX414120	41 x 41	2.09	2.65	5.84	7.62	2.46	3.72
GPX414125	41 x 41	2.53	3.28	7.08	9.25	2.98	4.51
GPX2M412120	41 x 21	1.55	1.99	0.95	4.44	0.75	2.17
GPX2M414120	41 x 41	2.09	2.65	5.84	7.62	2.46	3.72
SPZ271820	27 x 18	1,2	0.84	0.37	0.97	0.34	0.71
SPZ271830	27 x 18	1,2	0.84	0.37	0.97	0.34	0.71
SPZ384020	38 x 40	2,4	2.55	5.39	6.18	2.39	3.25
SPZ384025	38 x 40	2,4	2.55	5.39	6.18	2.39	3.25
SPZ384030	38 x 40	2,4	2.55	5.39	6.18	2.39	3.25
SPZ384035	38 x 40	2,4	2.55	5.39	6.18	2.39	3.25
SPZ384040	38 x 40	2,4	2.55	5.39	6.18	2.39	3.25
SPZ384050	38 x 40	2,4	2.55	5.39	6.18	2.39	3.25
SPZ384060	38 x 40	2,4	2.55	5.39	6.18	2.39	3.25
SPX412115	41 x 21	1,88	2.28	1.32	5.54	1.03	2.70
SPX412130	41 x 21	1,88	2.28	1.32	5.54	1.03	2.70
SPX412145	41 x 21	1,88	2.28	1.32	5.54	1.03	2.70
SPX414115	41 x 41	2,7	3.28	7.08	9.25	2.98	4.51
SPX414130	41 x 41	2,7	3.28	7.08	9.25	2.98	4.51
SPX414145	41 x 41	2,7	3.28	7.08	9.25	2.98	4.51
SPX414160	41 x 41	2,7	3.28	7.08	9.25	2.98	4.51
SPX414175	41 x 41	2,7	3.28	7.08	9.25	2.98	4.51
SPX414110	41 x 41	2,7	3.28	7.08	9.25	2.98	4.51
SPX414110	41 x 41	2,7	3.28	7.08	9.25	2.98	4.51

RESISTENCIAS Y CARGAS ADMISIBLES PARA PERFILES DE SOPORTACIÓN

*Valores calculados sin superar la tensión admisible $\sigma_{adm} = 16 \text{ N/mm}^2$ ni una flecha máxima $L/200$.
Para casos no recogidos en estos planteamientos, consultar con el departamento técnico de INDEX Fixing Systems.

EJEMPLO DE CÁLCULO

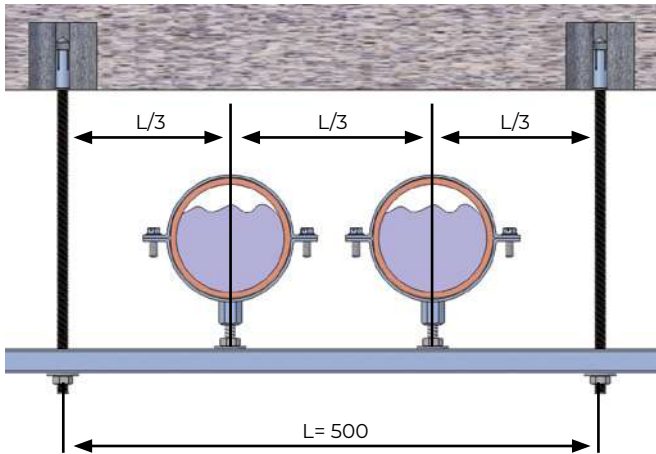

Guía GPG3840 con longitud entre apoyos (L) de 500 mm, con 2 cargas puntuales centradas (Caso 2)

CASO 1

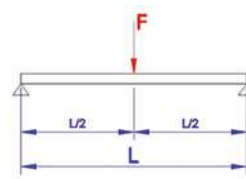

Carga puntual en el centro del brazo

CASO 2

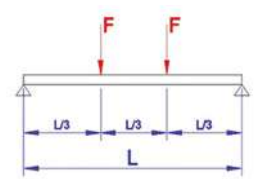

Dos cargas puntuales en L/3

CASO 3

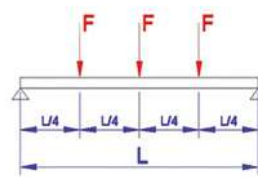

Tres cargas puntuales en L/4

CASO 4

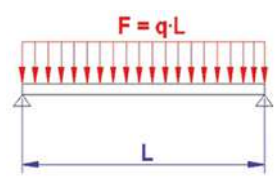

Carga uniforme

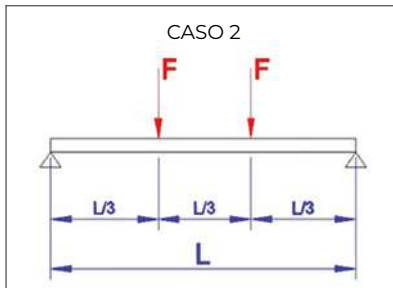

Para el valor de $L=500$ y para el perfil de soportación GPG3840, tenemos un valor de resistencia del perfil de $2600 \text{ N} \approx 260 \text{ kg}$



Guía
28 / 30

—	C. 1
—	C. 2
—	C. 3
—	C. 4

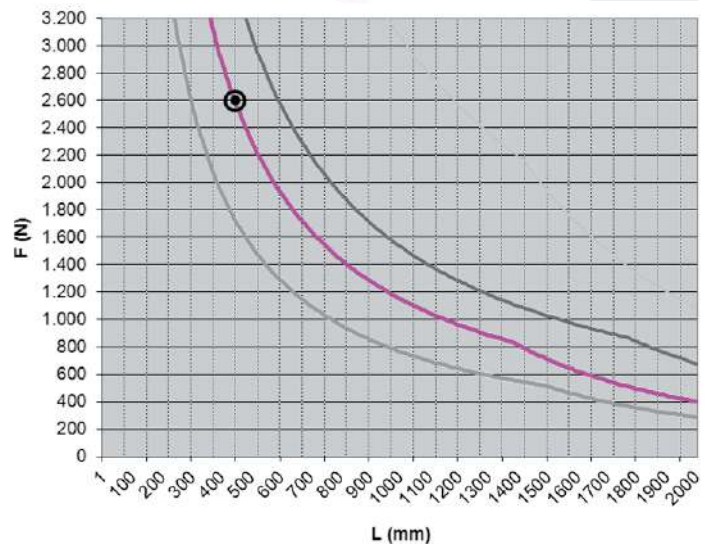

SOPORTES PERFORADOS

CASO 1

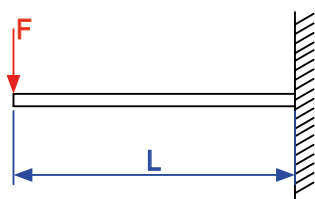

Carga puntual en extremo

CASO 2

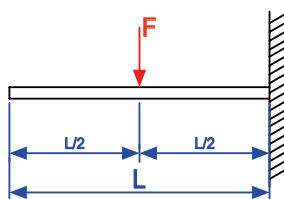

Carga puntual en el centro del brazo

CASO 3

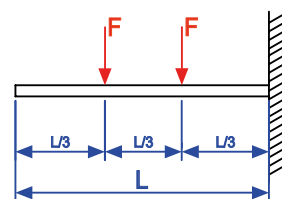

Dos cargas puntuales en L/3

CASO 4

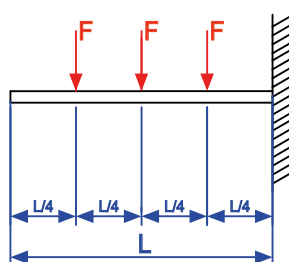

Tres cargas puntuales en L/4

CASO 5

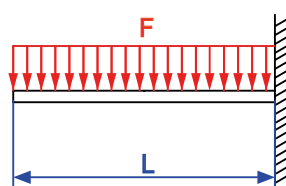

Carga uniforme

Soporte 27 / 18

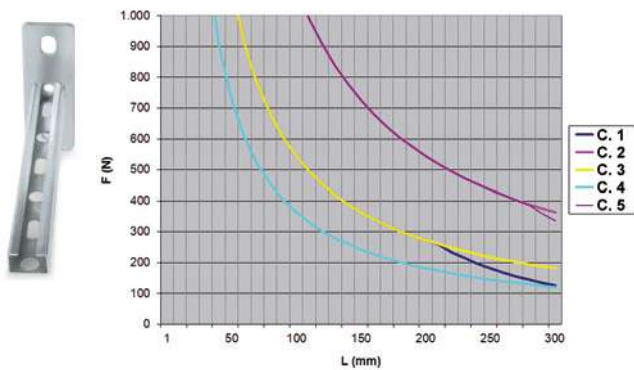

Soporte 41 / 21

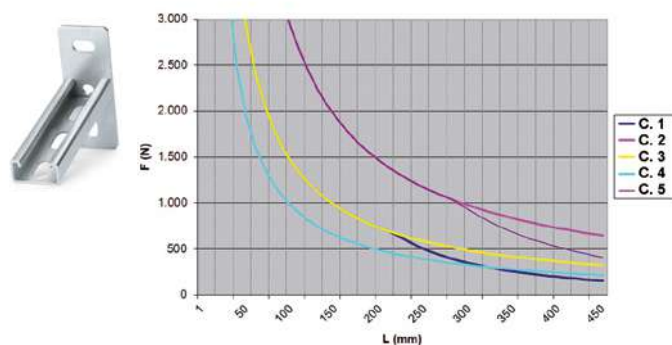

Soporte 38 / 40

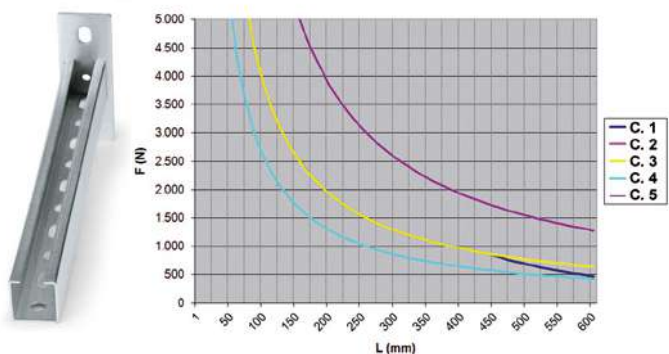

Soporte 41 / 41

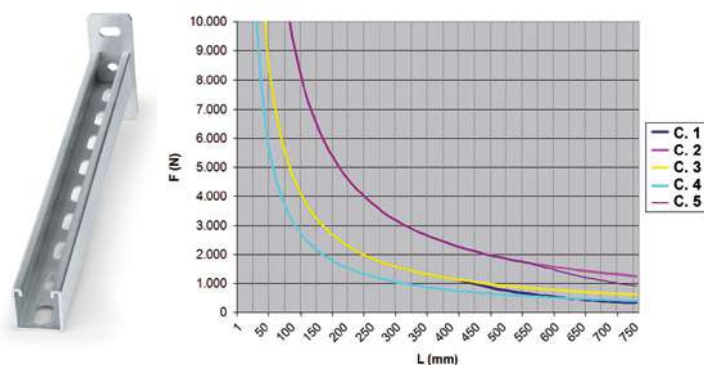

GUÍAS

CASO 1

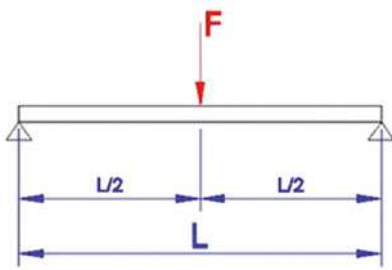

Carga puntual en el centro del brazo

CASO 2

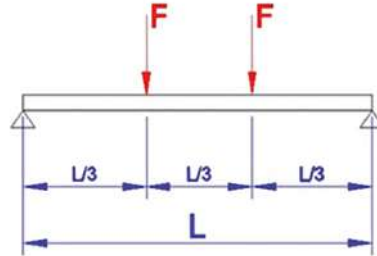

Dos cargas puntuales en $L/3$

CASO 3

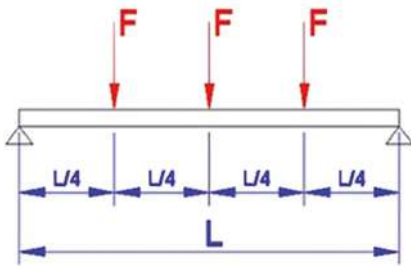

Tres cargas puntuales en $L/4$

CASO 4

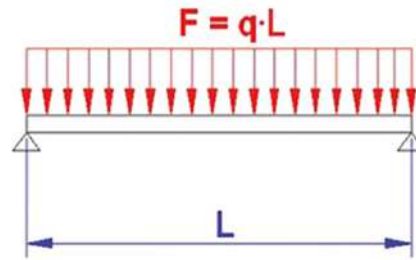

Carga uniforme



Guía
20 / 10



Guía
25 / 08

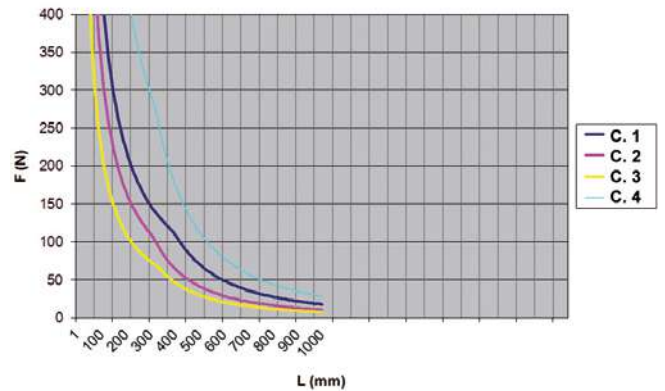
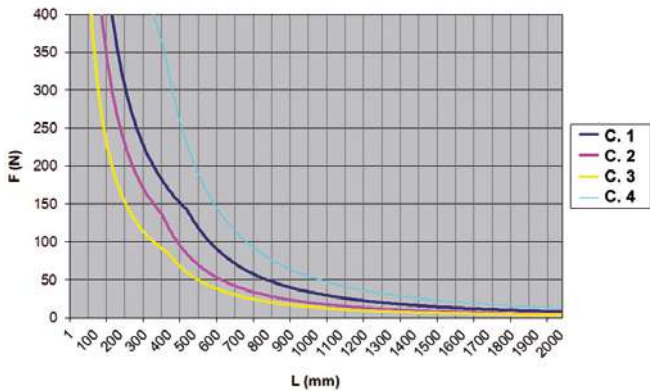



Guía
27 / 18

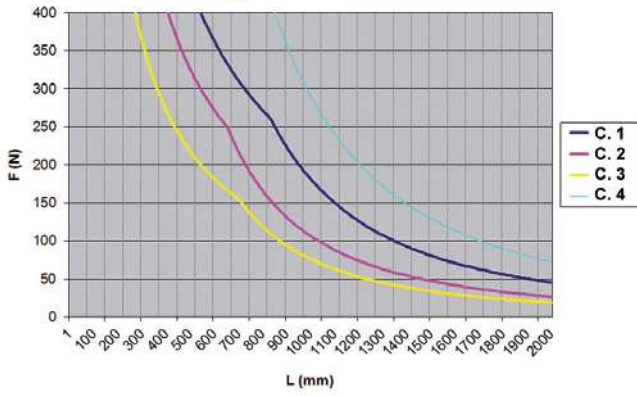

Guía
28 / 30

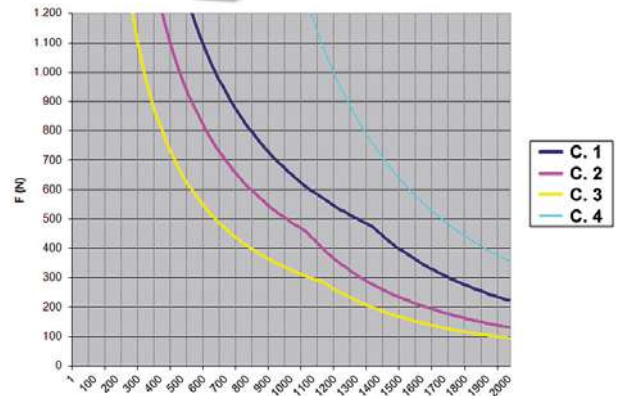

Guía
38 / 40

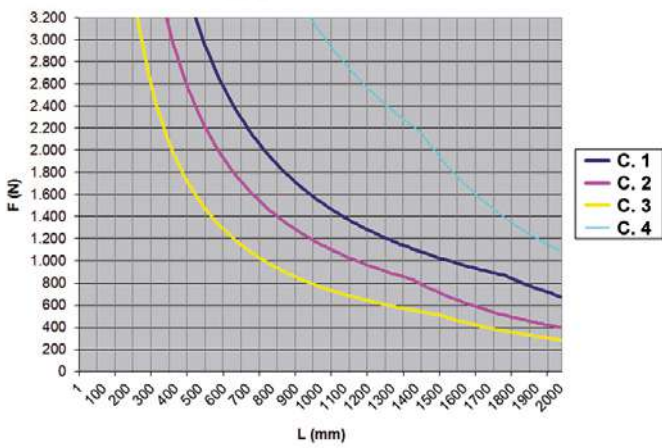

Guía
40 / 20

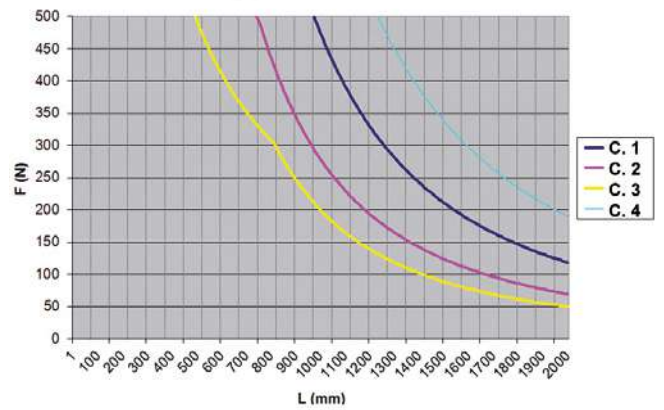

Guía
41 / 21

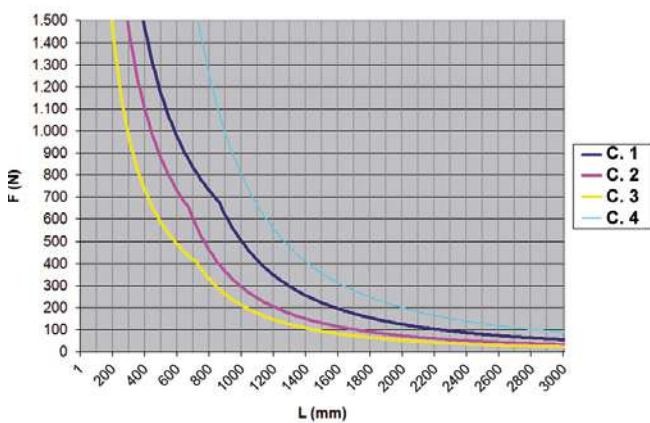

Guía
41 / 41

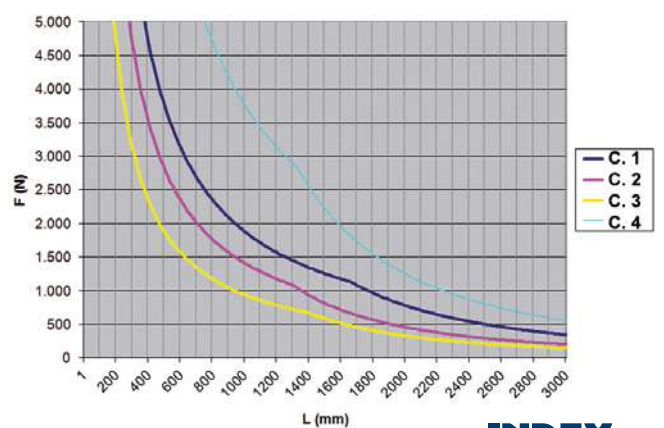

SU

Sistemas de fijación rápida en viga

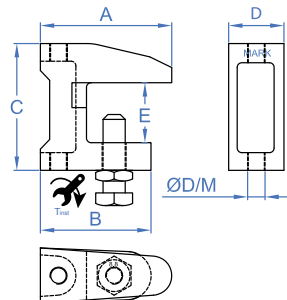

SU-MO

Mordaza para viga

CODIGO	A	B	C	D	E	PAR DE APRIETE	LLAVE DE INSTALACIÓN (SW)	ØD (MM)	MEDIDA TORNILLO
SUMOP09	38	35	37	18	20	10	13	PASANTE Ø9	M8 x 35
SUMOP11	44	41	42	21	20	15	17	PASANTE Ø11	M10 x 40
SUMOP13	58	48	54	24	25	15	17	PASANTE Ø13	M10 x 50
SUMOM06	38	35	37	18	20	10	13	ROSCADO M6	M6 x 35
SUMOM08	38	35	37	18	20	10	13	ROSCADO M8	M8 x 35
SUMOM10	44	41	42	21	20	15	17	ROSCADO M10	M10 x 40
SUMOM12	58	48	54	24	25	15	17	ROSCADO M12	M10 x 50

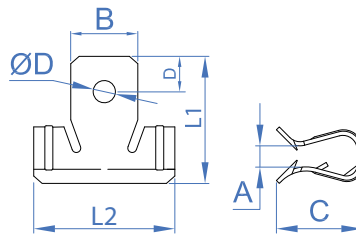

SU-CL

Clip de suspensión

CODIGO	A	B	C	D	L1	L2	ØD (MM)
SUCL02	1,5 - 4	13	14	10	28	28	6.3
SUCL04	4 - 10	19	23	10	34	40	6.3
SUCL10	10 - 15	19	23	10	40	40	6.3
SUCL15	15 - 20	19	23	10	40	40	6.3

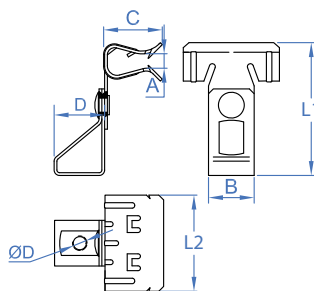

SU-VA

Clip varilla

CODIGO	A	B	C	D	L1	L2	ØD (MM)
SUVA0602	1,5 - 4	19	14	21	50	28	M6
SUVA0604	4 - 10	19	23	21	54	40	M6
SUVA0610	10 - 15	19	23	21	60	40	M6
SUVA0615	15 - 20	19	23	21	60	40	M6
SUVA0804	1,5 - 4	19	14	21	50	28	M8
SUVA0810	4 - 10	19	23	21	54	40	M8
SUVA0815	10 - 15	19	23	21	60	40	M8
SUVA0802	15 - 20	19	23	21	60	40	M8

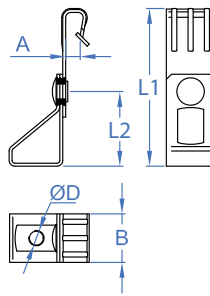

SU-CU

Clip de cuelgue

CODIGO	A	B	L1	L2	ØD (MM)
SUCU0602	1,5 - 5	19	65	30	M6
SUCU0605	5 - 7	19	65	30	M6
SUCU0606	3 - 7	19	80	30	M6
SUCU0607	7 - 10	19	95	30	M6

SU-AB

Clip de viga para abrazadera

CÓDIGO	ESPESES MÁX. A FIJAR	ANCHO MÁX. DE VIGA	ØD (MM)	H1	H3	MEDIDA TORNILLO
SUAB0603	3 - 7	36,5	M6	30	36,5	M6x9
SUAB0607	7 - 13	36,5	M6	36	36,5	M6x9
SUAB0614	14 - 20	36,5	M6	43	36,5	M6x9

SU-CA

Clip de viga para cable

CÓDIGO	ESPESES MÁX. A FIJAR	ØD (MM)	GROSOR
SUCA0602	1 - 4	6-7	0,6
SUCA0604	4 - 7,5	6-7	0,6
SUCA0607	7,5 - 12	6-7	0,6
SUCA0802	1 - 4	8-9	0,6
SUCA0804	4 - 7,5	8-9	0,6
SUCA0807	7,5 - 12	8-9	0,6
SUCA1002	1 - 4	10-11	0,6
SUCA1004	4 - 7,5	10-11	0,6
SUCA1007	7,5 - 12	10-11	0,6
SUCA1202	1 - 4	12-14	0,6
SUCA1204	4 - 7,5	12-14	0,6
SUCA1207	7,5 - 12	12-14	0,6
SUCA1502	1 - 4	15-18	0,6
SUCA1504	4 - 7,5	15-18	0,6
SUCA1507	7,5 - 12	15-18	0,6
SUCA1902	1 - 4	19-24	0,6
SUCA1904	4 - 7,5	19-24	0,6
SUCA1907	7,5 - 12	19-24	0,6
SUCA2502	1 - 4	25-30	0,6
SUCA2504	4 - 7,5	25-30	0,6
SUCA2507	7,5 - 12	25-30	0,6

TAG

Tirafondo abrazadera y grapa

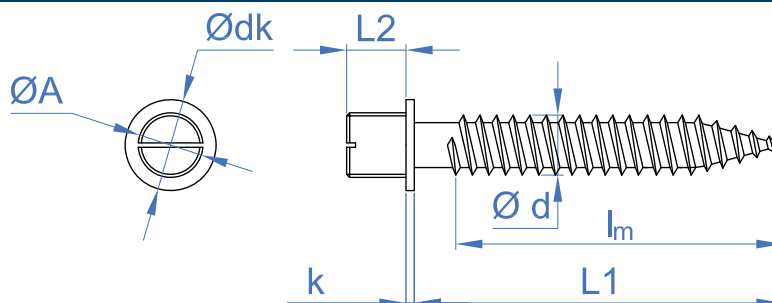

AB-TA

Cincado. Ranurado

CODIGO	METRICA	ØD	L1	L2	K	ØDK	LONGITUD DE ROSCA
ABTA0630	M6	5	30	6	1	8	30
ABTA0640	M6	5	40	6	1	8	40
ABTA0650	M6	5	50	6	1	8	50
ABTA0730	M7	6	22	6	1	9,5	-
ABTA0740	M7	6	32	6	1	9,5	-
ABTA0750	M7	6	42	6	1	9,5	-

CODIGO	METRICA	ØD	L1	L2	K	ØDK	LONGITUD DE ROSCA
ABTA0760	M7	6	52	6	1	9,5	-
ABTA0770	M7	6	62	6	1	9,5	-
ABTA0780	M7	6	72	6	1	9,5	-
ABTA0840	M8	6	40	7,5	1,4	8,5	40
ABTA0860	M8	6	60	7,5	1,4	8,5	60
ABTA0880	M8	6	80	7,5	1,4	8,5	45
ABTA1050	M10	8	50	9	1,7	12	50
ABTA1070	M10	8	70	9	1,7	12	45
ABTA1090	M10	8	90	9	1,7	12	45

AB-TA B Bicromatado. Ranurado

CODIGO	METRICA	ØD	L1	L2	K	ØDK	LONGITUD DE ROSCA
ABTAB0630	M6	5	30	6	1	8	30
ABTAB0640	M6	5	40	6	1	8	40
ABTAB0650	M6	5	50	6	1	8	50

AB-TA A2 Inoxidable A2. Ranurado

CODIGO	METRICA	ØD	L1	L2	K	ØDK	LONGITUD DE ROSCA
ABTA20630	M6	5	30	7	1,2	7,8	30

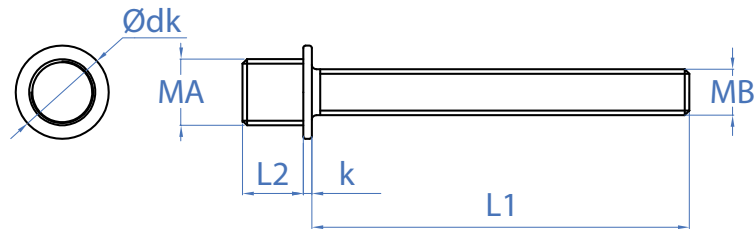

AB-TR Tornillo doble para abrazaderas

CODIGO	METRICA	L1	L2	K	ØDK
ABTR05030	M7	30	6	1	9
ABTR05040	M7	40	6	1	9
ABTR05050	M7	50	6	1	9
ABTR05060	M7	60	6	1	9
ABTR06040	M7	40	6	1	9
ABTR06050	M7	50	6	1	9
ABTR06060	M7	60	6	1	9

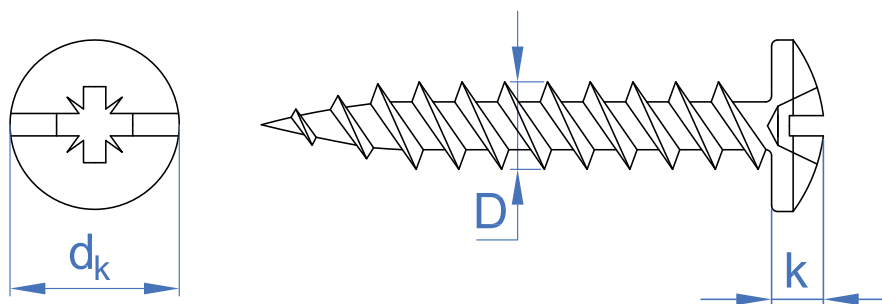

AB-TG Tirafondo grapa. Huella combi

CODIGO	LONGITUD	LLAVE DE INSTALACION	ØDK	K	ØD(MM)Ø0
ABTG4530	30	PZ2	10	3	4,5
ABTG4535	35	PZ2	10	3	4,5
ABTG4540	40	PZ2	10	3	4,5
ABTG5030	30	PZ3	12	3	5
ABTG5040	40	PZ3	12	3	5

ES-DR

Espárrago de doble rosca

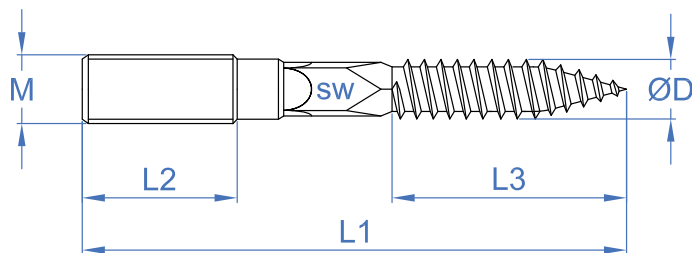

ES-DR

Cincado. Tx

CODIGO	METRICA	LONGITUD	ØD(MM)	LLAVE DE INSTALACIÓN (SW)	L1	L2	L3
ESDR06040	M6	40	6	-	40	12	24
ESDR06050	M6	50	6	-	50	16	28,5
ESDR06060	M6	60	6	-	60	18	34,5
ESDR06070	M6	70	6	-	70	26	34,5
ESDR06080	M6	80	6	-	80	34	34,5
ESDR08050	M8	50	7	-	50	13	29,5
ESDR08060	M8	60	7	-	60	15	37,5
ESDR08070	M8	70	7	-	70	25	37,5
ESDR08080	M8	80	7	6	80	28,5	37,5
ESDR08090	M8	90	7	6	90	28,5	48,5
ESDR08100	M8	100	7	6	100	33,5	48,5
ESDR08110	M8	110	7	6	110	42,5	48,5
ESDR08120	M8	120	7	6	120	50	48,5
ESDR08130	M8	130	7	6	130	50	48,5
ESDR10080	M10	80	8	8	80	18	46,5
ESDR10100	M10	100	9	8	100	24	57
ESDR10110	M10	110	9	8	110	38	57
ESDR10120	M10	120	9	8	120	45	57
ESDR10130	M10	130	9	8	130	50	57
ESDR10140	M10	140	9	8	140	50	57
ESDR10150	M10	150	9	8	150	50	57
ESDR10180	M10	180	9	8	180	50	57
ESDR10200	M10	200	9	8	200	50	57

ES-DA2

Inoxidable A2. Tx

CODIGO	METRICA	LONGITUD	ØD(MM)	LLAVE DE INSTALACIÓN (SW)	L1	L2	L3
ESDA208060	M8	60	7	6	60	20	30
ESDA210060	M10	60	9	8	60	20	30

TALA

Taco de latón para fijaciones ligeras en materiales macizos

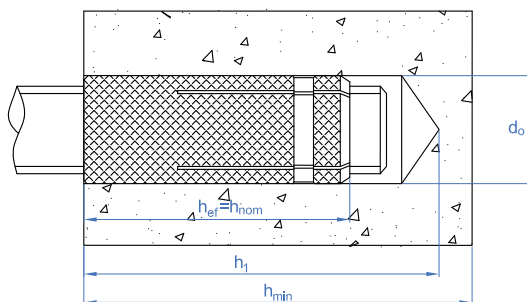

TALA

Taco de latón para fijaciones ligeras en materiales macizos

CÓDIGO	MXL	Ø BROCA	PROFUNDIDAD MÍN. DE TALADRO	MÍN. ESPESOR MATERIAL BASE	DISTANCIA MÍN. AL BORDE "A"	DISTANCIA MÍN. ENTRE EJES "B"	EXTRACCIÓN HORMIGÓN NO-FISURADO
TALA532	W5/32x16	5	20	25	24	48	60
TALAM04	M4 x 16	5	20	25	24	48	60
TALAM05	M5 x 18	6	22	30	27	54	70
TALAM06	M6 x 23	8	28	35	35	69	100
TALAM08	M8 x 28	10	33	40	42	84	150
TALAM10	M10 x 33	12	40	45	51	102	210
TALAM12	M12 x 38	15	45	50	57	114	320

TA-ME

Taco de expansión metálico

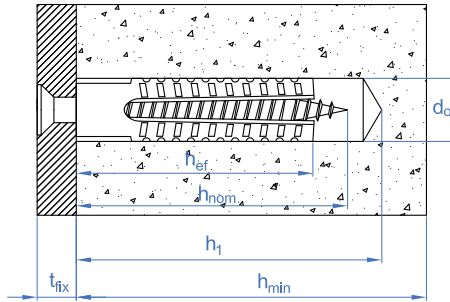

TA-ME

Taco de expansión metálico

CÓDIGO	MXL	Ø BROCA	PROFUNDIDAD MÍN. DE TALADRO	MÍN. ESPESOR MATERIAL BASE	DISTANCIA MÍN. AL BORDE "A"	DISTANCIA MÍN. ENTRE EJES "B"	EXTRACCIÓN HORMIGÓN NO-FISURADO
TAME05030	M5 x 30	5	40	60	60	120	20
TAME06032	M6 x 32	6	40	60	60	120	22
TAME08038	M8 x 38	8	50	70	70	140	40
TAME08060	M8 x 60	8	70	120	120	240	47
TAME10060	M10 x 60	10	70	120	120	240	52

HE

Anclaje hembra con cono interior para grandes cargas

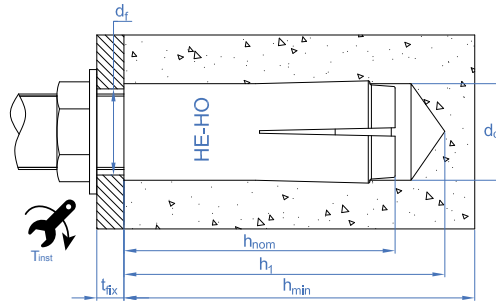

HE-HO

Homologado ETE Opción 7

CÓDIGO	MXL	Ø BROCA	PROFUNDIDAD MÍN. DE TALADRO	PROFUNDIDAD MÍN. DEL ANCLAJE	PAR DE APRIETE (NM)	Ø ELEMENTO A FIJAR	MÍN. ESPESOR MATERIAL BASE	DISTANCIA MÍN. AL BORDE "A"	DISTANCIA MÍN. ENTRE EJES "B"	EXTRACCIÓN HORMIGÓN NO-FISURADO	CIZALLADURA HORMIGÓN NO-FISURADO
HEHOM06	M6	8	27	25	4	7	100	105	60	249	298
HEHOM08	M8	10	33	30	11	9	100	105	60	327	392
HEHOM10	M10	12	43	40	17	12	100	140	80	432	530
HEHOM12	M12	15	54	50	38	14	100	175	100	603	844
HEHOM16	M16	20	70	65	60	18	130	230	130	894	1893
HEHOM20	M20	25	86	80	100	22	160	280	160	1220	2767
HEHOM12D	M12	16	54	50	38	14	100	175	100	603	844

HE-A4

Inoxidable A4. Homologado ETE Aplicaciones no estructurales

CÓDIGO	MXL	Ø BROCA	PROFUNDIDAD MÍN. DE TALADRO	PROFUNDIDAD MÍN. DEL ANCLAJE	PAR DE APRIETE (NM)	Ø ELEMENTO A FIJAR	MÍN. ESPESOR MATERIAL BASE	DISTANCIA MÍN. AL BORDE "A"	DISTANCIA MÍN. ENTRE EJES "B"	EXTRACCIÓN HORMIGÓN NO-FISURADO	CIZALLADURA HORMIGÓN NO-FISURADO
HEA4M06	M6	8	27	25	4	7	80	150	200	87	87
HEA4M08	M8	10	33	30	11	9	80	150	200	121	121
HEA4M10	M10	12	43	40	17	12	80	150	200	121	121
HEA4M12	M12	15	54	50	38	14	100	150	200	225	225
HEA4M16	M16	20	70	65	60	18	130	195	260	433	433
HEA4M20	M20	25	86	80	100	22	160	240	320	572	572

HE-CL

Con collarín. Cincado. Homologado ETE Opt.7 y para aplicaciones no estructurales

CÓDIGO	MXL	Ø BROCA	PROFUNDIDAD MÍN. DE TALADRO	PROFUNDIDAD MÍN. DEL ANCLAJE	PAR DE APRIETE (NM)	Ø ELEMENTO A FIJAR	MÍN. ESPESOR MATERIAL BASE	DISTANCIA MÍN. AL BORDE "A"	DISTANCIA MÍN. ENTRE EJES "B"	EXTRACCIÓN HORMIGÓN NO-FISURADO	CIZALLADURA HORMIGÓN NO-FISURADO
HECLOM06	M6	8	27	25	4	7	100	105	60	249	298
HECLOM08	M8	10	33	30	11	9	100	105	90	327	392
HECLOM10	M10	12	43	40	17	12	100	140	80	432	530
HECLOM12	M12	15	54	50	38	14	100	175	100	603	844
HECLOM16	M16	20	70	65	60	18	130	230	130	894	1893
HECLOM12D	M12	16	54	50	38	14	100	175	160	603	844

HE-C4

Con collarín. Inoxidable A4. Homologado ETE Aplicaciones no estructurales

CÓDIGO	MXL	Ø BROCA	PROFUNDIDAD MÍN. DE TALADRO	PROFUNDIDAD MÍN. DEL ANCLAJE	PAR DE APRIETE (NM)	Ø ELEMENTO A FIJAR	MÍN. ESPESOR MATERIAL BASE	DISTANCIA MÍN. AL BORDE "A"	DISTANCIA MÍN. ENTRE EJES "B"	EXTRACCIÓN HORMIGÓN NO-FISURADO	CIZALLADURA HORMIGÓN NO-FISURADO
HEC4M06	M6	8	27	25	4	7	80	150	200	87	87
HEC4M08	M8	10	33	30	11	9	80	150	200	121	121
HEC4M10	M10	12	43	40	17	12	80	150	200	121	121
HEC4M12	M12	15	54	50	38	14	100	150	200	225	225

HE-HC

Versión corta. Cincado. Homologado ETE Aplicaciones no estructurales

CÓDIGO	MXL	Ø BROCA	PROFUNDIDAD MÍN. DE TALADRO	PROFUNDIDAD MÍN. DEL ANCLAJE	PAR DE APRIETE (NM)	Ø ELEMENTO A FIJAR	MÍN. ESPESOR MATERIAL BASE	DISTANCIA MÍN. AL BORDE "A"	DISTANCIA MÍN. ENTRE EJES "B"	EXTRACCIÓN HORMIGÓN NO-FISURADO	CIZALLADURA HORMIGÓN NO-FISURADO
HEHCM08	M8 x 25	10	28	25	11	9	80	60	75	101	101
HEHCM10	M10 x 25	12	28	25	17	12	80	60	75	162	162
HEHCM12	M12 x 25	15	29	25	38	14	80	60	75	162	162

HE-NO

Cincado

CÓDIGO	MXL	Ø BROCA	PROFUNDIDAD MÍN. DE TALADRO	PROFUNDIDAD MÍN. DEL ANCLAJE	PAR DE APRIETE (NM)	Ø ELEMENTO A FIJAR	MÍN. ESPESOR MATERIAL BASE	DISTANCIA MÍN. AL BORDE "A"	DISTANCIA MÍN. ENTRE EJES "B"	EXTRACCIÓN HORMIGÓN NO-FISURADO	CIZALLADURA HORMIGÓN NO-FISURADO
HENOM06	M6	8	27	25	4	7	100	105	60	175	298
HENOM08	M8	10	33	30	11	9	100	105	90	230	392
HENOM10	M10	12	43	40	17	12	100	140	80	354	530
HENOM12	M12	15	54	50	38	14	100	175	100	494	844
HENOM16	M16	20	70	65	60	18	130	230	130	733	1893
HENOM20	M20	25	86	80	100	22	160	280	160	1000	2767

TAG

Tirafondo abrazadera y grapa

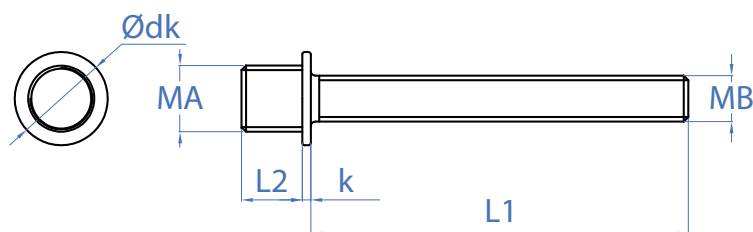

AB-TR

Tornillo doble para abrazaderas

CODIGO	METRICA	L1	L2	K	ØDK
ABTR05030	M7	30	6	1	9
ABTR05040	M7	40	6	1	9
ABTR05050	M7	50	6	1	9
ABTR05060	M7	60	6	1	9
ABTR06040	M7	40	6	1	9
ABTR06050	M7	50	6	1	9
ABTR06060	M7	60	6	1	9

T-NUX

Taco de nylon universal de alto rendimiento

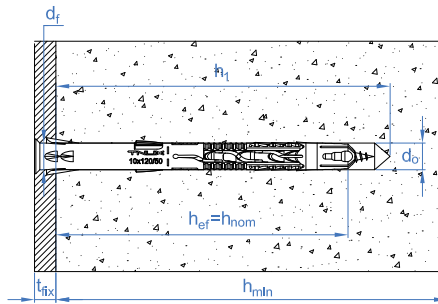

T-NUX A

Cabeza avellanada. Cincado. Homologado ETE

CÓDIGO	MXL	ESPESOR MÁX. A FIJAR	Ø BROCA	PROFUNDIDAD MÍN. DE TALADRO	PROFUNDIDAD MÍN. DEL ANCLAJE	LLAVE DE INSTALACIÓN	Ø ELEMENTO A FIJAR	MÍN. ESPESOR MATERIAL BASE	DISTANCIA MÍN. AL BORDE "A"	DISTANCIA MÍN. ENTRE EJES "B"	EXTRACCIÓN HORMIGÓN NO-FISURADO	CIZALLADURA HORMIGÓN NO-FISURADO
TNUXA08060	8 x 60	10	8	70	50	TX30	8 - 8,5	100	60	100	141	263
TNUXA08080	8 x 80	10	8	90	70	TX30	8 - 8,5	100	60	100	141	263
TNUXA08100	8 x 100	30	8	90	70	TX30	8 - 8,5	100	60	100	141	263
TNUXA08120	8 x 120	50	8	90	70	TX30	8 - 8,5	100	60	100	141	263
TNUXA10060	10 x 60	10	10	70	50	TX40	10 - 11	100	60	100	202	364
TNUXA10080	10 x 80	10	10	90	70	TX40	10 - 11	100	70	100	202	364
TNUXA10100	10 x 100	30	10	90	70	TX40	10 - 11	100	70	100	202	364
TNUXA10120	10 x 120	50	10	90	70	TX40	10 - 11	100	70	100	202	364
TNUXA10140	10 x 140	70	10	90	70	TX40	10 - 11	100	70	100	202	364
TNUXA10160	10 x 160	90	10	90	70	TX40	10 - 11	100	70	100	202	364
TNUXA10180	10 x 180	110	10	90	70	TX40	10 - 11	100	70	100	202	364
TNUXA10200	10 x 200	130	10	90	70	TX40	10 - 11	100	70	100	202	364
TNUXA10230	10 x 230	160	10	90	70	TX40	10 - 11	100	70	100	202	364

T-NUX A A4

Inoxidable A4. Cabeza avellanada. Homologado ETE

CÓDIGO	MXL	ESPESOR MÁX. A FIJAR	Ø BROCA	PROFUNDIDAD MÍN. DE TALADRO	PROFUNDIDAD MÍN. DEL ANCLAJE	LLAVE DE INSTALACIÓN	Ø ELEMENTO A FIJAR	MÍN. ESPESOR MATERIAL BASE	DISTANCIA MÍN. AL BORDE "A"	DISTANCIA MÍN. ENTRE EJES "B"	EXTRACCIÓN HORMIGÓN NO-FISURADO	CIZALLADURA HORMIGÓN NO-FISURADO
TNXA408080	8 x 80	10	8	90	70	TX30	8 - 8,5	100	60	100	141	307
TNXA408100	8 x 100	30	8	90	70	TX30	8 - 8,5	100	60	100	141	307
TNXA408120	8 x 120	50	8	90	70	TX30	8 - 8,5	100	60	100	141	307
TNXA410080	10 x 80	10	10	90	70	TX40	10 - 11	100	70	100	202	425
TNXA410100	10 x 100	30	10	90	70	TX40	10 - 11	100	70	100	202	425
TNXA410120	10 x 120	50	10	90	70	TX40	10 - 11	100	70	100	202	425
TNXA410140	10 x 140	70	10	90	70	TX40	10 - 11	100	70	100	202	425

T-NUX E

Cabeza hexagonal. Cincado. Homologado ETE

CÓDIGO	MXL	ESPESOR MÁX. A FIJAR	Ø BROCA	PROFUNDIDAD MÍN. DE TALADRO	PROFUNDIDAD MÍN. DEL ANCLAJE	LLAVE DE INSTALACIÓN	Ø ELEMENTO A FIJAR	MÍN. ESPESOR MATERIAL BASE	DISTANCIA MÍN. AL BORDE "A"	DISTANCIA MÍN. ENTRE EJES "B"	EXTRACCIÓN HORMIGÓN NO-FISURADO	CIZALLADURA HORMIGÓN NO-FISURADO
TNUXE08060	8 x 60	10	8	70	50	SW10/TX30	8 - 8,5	100	60	100	141	263
TNUXE08080	8 x 80	10	8	90	70	SW10/TX30	8 - 8,5	100	60	100	141	263
TNUXE08100	8 x 100	30	8	90	70	SW10/TX30	8 - 8,5	100	60	100	141	263
TNUXE08120	8 x 120	50	8	90	70	SW10/TX30	8 - 8,5	100	60	100	141	263
TNUXE10060	10 x 60	10	10	70	50	SW13/TX40	10 - 11	100	70	100	202	364
TNUXE10080	10 x 80	10	10	90	70	SW13/TX40	10 - 11	100	70	100	202	364
TNUXE10100	10 x 100	30	10	90	70	SW13/TX40	10 - 11	100	70	100	202	364
TNUXE10120	10 x 120	50	10	90	70	SW13/TX40	10 - 11	100	70	100	202	364
TNUXE10140	10 x 140	70	10	90	70	SW13/TX40	10 - 11	100	70	100	202	364
TNUXE10160	10 x 160	90	10	90	70	SW13/TX40	10 - 11	100	70	100	202	364
TNUXE10180	10 x 180	110	10	90	70	SW13/TX40	10 - 11	100	70	100	202	364
TNUXE10200	10 x 200	130	10	90	70	SW13/TX40	10 - 11	100	70	100	202	364
TNUXE10230	10 x 230	160	10	90	70	SW13/TX40	10 - 11	100	70	100	202	364

T-NUX E A4

Inoxidable A4. Cabeza hexagonal. Homologado ETE

CÓDIGO	MXL	ESPESOR MÁX. A FIJAR	Ø BROCA	PROFUNDIDAD MÍN. DE TALADRO	PROFUNDIDAD MÍN. DEL ANCLAJE	LLAVE DE INSTALACIÓN	Ø ELEMENTO A FIJAR	MÍN. ESPESOR MATERIAL BASE	DISTANCIA MÍN. AL BORDE "A"	DISTANCIA MÍN. ENTRE EJES "B"	EXTRACCIÓN HORMIGÓN NO-FISURADO	CIZALLADURA HORMIGÓN NO-FISURADO
TNXE408080	8 x 80	10	8	90	70	SW10/TX30	8 - 8,5	100	60	100	141	307
TNXE408100	8 x 100	30	8	90	70	SW10/TX30	8 - 8,5	100	60	100	141	307
TNXE410080	10 x 80	10	10	90	70	SW13/TX40	10 - 11	100	70	100	202	425
TNXE410100	10 x 100	30	10	90	70	SW13/TX40	10 - 11	100	70	100	202	425
TNXE410120	10 x 120	50	10	90	70	SW13/TX40	10 - 11	100	70	100	202	425
TNXE410140	10 x 140	70	10	90	70	SW13/TX40	10 - 11	100	70	100	202	425

T-NUX T

Cabeza Truss inviolable. Cincado. Homologado ETE

CÓDIGO	MXL	ESPEJOR MÁX. A FIJAR	Ø BROCA	PROFUNDIDAD MÍN. DE TALADRO	PROFUNDIDAD MÍN. DEL ANCLAJE	LLAVE DE INSTALACIÓN	Ø ELEMENTO A FIJAR	MÍN. ESPEJOR MATERIAL BASE	DISTANCIA MÍN. AL BORDE "A"	DISTANCIA MÍN. ENTRE EJES "B"	EXTRACCIÓN HORMIGÓN NO-FISURADO	CIZALLADURA HORMIGÓN NO-FISURADO
TNUXT10080	10 x 80	10	10	70	50	TX40	10 - 11	100	70	100	202	425
TNUXT10100	10 x 100	30	10	90	70	TX40	10 - 11	100	70	100	202	425
TNUXT10120	10 x 120	50	10	90	70	TX40	10 - 11	100	70	100	202	425
TNUXT10140	10 x 140	70	10	90	70	TX40	10 - 11	100	70	100	202	425
TNUXT10160	10 x 160	90	10	90	70	TX40	10 - 11	100	70	100	202	425

T-FUX E

Taco cabeza cilíndrica. Tornillo cabeza hexagonal. Cincado. Homologado ETE

CÓDIGO	MXL	ESPEJOR MÁX. A FIJAR	Ø BROCA	PROFUNDIDAD MÍN. DE TALADRO	PROFUNDIDAD MÍN. DEL ANCLAJE	LLAVE DE INSTALACIÓN	Ø ELEMENTO A FIJAR	MÍN. ESPEJOR MATERIAL BASE	DISTANCIA MÍN. AL BORDE "A"	DISTANCIA MÍN. ENTRE EJES "B"	EXTRACCIÓN HORMIGÓN NO-FISURADO	CIZALLADURA HORMIGÓN NO-FISURADO
TFUXE10080	10 x 80	10	10	90	70	SW13/TX40	10 - 11	100	70	100	202	425
TFUXE10100	10 x 100	30	10	90	70	SW13/TX40	10 - 11	100	70	100	202	425
TFUXE10120	10 x 120	50	10	90	70	SW13/TX40	10 - 11	100	70	100	202	425

TC

Taco clavable de poliamida 6.6, premontado con tornillo rosca-arpón

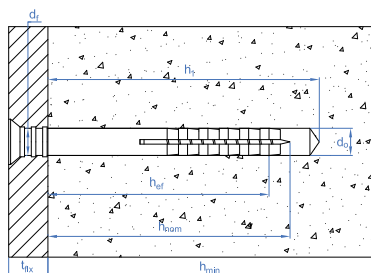

TC-CA

Taco con cabeza avellanada

CÓDIGO	MXL	ESPEJOR MÁX. A FIJAR	Ø BROCA	PROFUNDIDAD MÍN. DE TALADRO	Nº HUELLA	EXTRACCIÓN HORMIGÓN NO-FISURADO	CIZALLADURA HORMIGÓN NO-FISURADO	EXTRACCIÓN LADRILLO MACIZO
TCCA05025	5 x 25	5	5	30	PZ2	13	20	3
TCCA05030	5 x 30	5	5	30	PZ2	13	20	3
TCCA05035	5 x 35	10	5	30	PZ2	13	20	3
TCCA05050	5 x 50	25	5	30	PZ2	13	20	3
TCCA06035	6 x 35	10	6	35	PZ2	18	26	4
TCCA06040	6 x 40	10	6	35	PZ2	18	26	4
TCCA06050	6 x 50	20	6	35	PZ2	18	26	4
TCCA06060	6 x 60	30	6	35	PZ2	18	26	4
TCCA06070	6 x 70	40	6	35	PZ2	18	26	4
TCCA06080	6 x 80	50	6	35	PZ2	18	26	4
TCCA08060	8 x 60	20	8	45	PZ3	29	30	7
TCCA08080	8 x 80	40	8	45	PZ3	29	30	7
TCCA08100	8 x 100	60	8	45	PZ3	29	30	7
TCCA08120	8 x 120	80	8	45	PZ3	29	30	7
TCCA08140	8 x 135	100	8	45	PZ3	29	30	7

TC-SP

Taco clavable de alta expansión

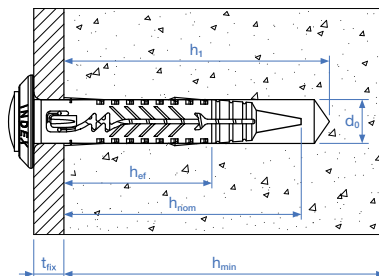

TC-SP

Taco con cabeza avellanada

CÓDIGO	MXL	ESPEJOR MÁX. A FIJAR	Ø BROCA	PROFUNDIDAD MÍN. DE TALADRO	Nº HUELLA	EXTRACCIÓN HORMIGÓN NO-FISURADO	EXTRACCIÓN LADRILLO MACIZO
TCSP05027	5 x 27	5	5	25	-	17	5
TCSP06032	6 x 32	5	6	30	-	26	7
TCSP06040	6 x 40	10	6	30	-	26	7

TN4S

Taco de nylon anudable de 4 segmentos para todo tipo de materiales

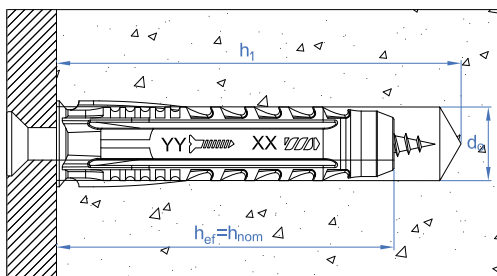

TN4S

Taco

CÓDIGO	MXL	Ø BROCA	PROFUNDIDAD MÍN. DE TALADRO	PROFUNDIDAD MÍN. DEL ANCLAJE	MÍN. ESPESOR MATERIAL BASE	EXTRACCIÓN HORMIGÓN NO-FISURADO	EXTRACCIÓN LADRILLO MACIZO	EXTRACCIÓN LADRILLO HUECO	MEDIDA TORNILLO
TN4S05	5 x 25	5	30	25	35	15	7	4	TPPO 2,5-4
TN4S06	6 x 30	6	40	30	45	15	7	4	TPPO 3,5-4
TN4S08	8 x 40	8	50	40	55	40	16	8	TPPO 4,5, TB 5-6
TN4S10	10 x 50	10	60	50	65	116	23	11	TB 6-8
TN4S12	12 x 60	12	70	60	75	108	40	20	TB 8-10
TN4S14	14 x 70	14	80	70	85	193	125	63	TB 10-12

TACON

Taco de nylon

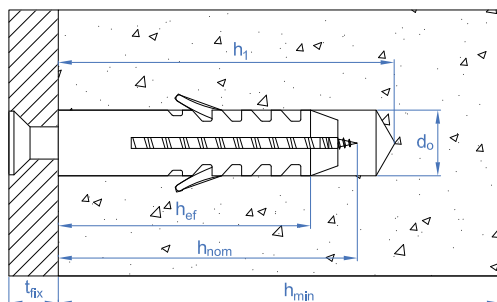

TACON/TACOL/TACOLA

Taco

CÓDIGO	MXL	Ø BROCA	PROFUNDIDAD MÍN. DE TALADRO	PROFUNDIDAD MÍN. DEL ANCLAJE	MÍN. ESPESOR MATERIAL BASE	EXTRACCIÓN HORMIGÓN NO-FISURADO	EXTRACCIÓN LADRILLO MACIZO	MEDIDA TORNILLO
TACON04	4 x 20	4	25	20	30	6	4	TPPO 2,5-3
TACON05/TACOL05/	5 x 25	5	35	25	40	7	5	TPPO 2,5-4
TACON06/TACOL06/TACOLA06	6 x 30	6	40	30	45	10	5	TPPO 3,5-4
TACON07	7 x 30	7	45	30	45	11	6	TPPO 4-4,5
TACON08/TACOL08	8 x 40	8	50	40	55	12	11	TPPO 4,5, TB 5-6
TACON10/TACOL10	10 x 50	10	60	50	70	61	16	TB 6-8
TACON12/TACOL12	12 x 60	12	70	60	80	76	28	TB 8-10
TACON14	14 x 70	14	80	70	95	167	88	TB 10-12
TACON16	16 x 80	16	90	80	100	240	100	TB 12-14

TAPLA

Taco para placas de yeso laminado

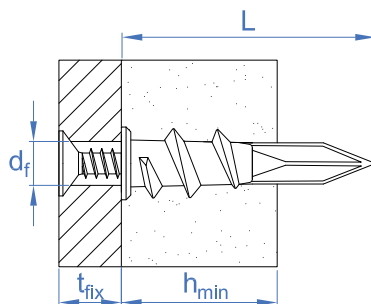

TAPLA NY

Taco de nylon

CÓDIGO	MXL	MÍN. ESPESOR MATERIAL BASE	VÁLIDO PARA	Nº HUELLA	EXTRACCIÓN CARTÓN YESO
TAPLANY	15 x 33	9-16	TPPO 4,5 x 40 / DIN-7981 4,2 x 38	PH3	8

TAPLA ME

Taco de Zamak con tornillo DIN 7981 4,2 x 32

CÓDIGO	MXL	MÍN. ESPESOR MATERIAL BASE	VÁLIDO PARA	Nº HUELLA	EXTRACCIÓN CARTÓN YESO
TAPLAME	13 x 32	9-16	DIN-7981 4,2 x 32	PH2/PH3	8

TAPLA ZK

Taco de Zamak

CÓDIGO	MXL	MÍN. ESPESOR MATERIAL BASE	VÁLIDO PARA	Nº HUELLA	EXTRACCIÓN CARTÓN YESO
TAPLAZK	13 x 37	9-16	TPPO 4,5 x 50 / DIN-7981 4,2 x 38	PZ3	8

ANCLA

Taco de nylon para ladrillos huecos y placas de yeso

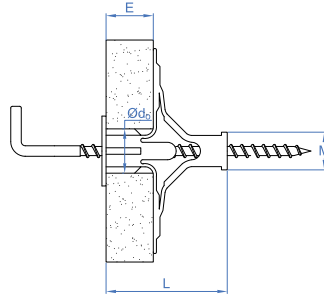

ANCLA

Taco de nylon para ladrillos huecos y placas de cartón yeso

CÓDIGO	MXL	Ø BROCA	MÍN. ESPESOR MATERIAL BASE	EXTRACCIÓN LADRILLO HUECO	EXTRACCIÓN CARTÓN YESO
ANCLA40	10 x 40	10	4-12	10	5
ANCLA47	10 x 47	10	15-19	10	5

MEDU

Taco universal con collarín y forma de nudo

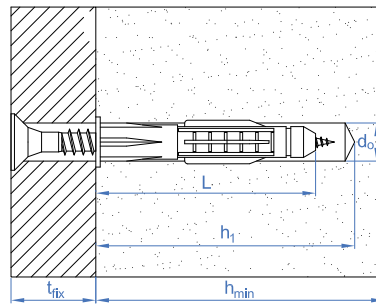

MEDU

Polipropileno

CÓDIGO	MXL	Ø BROCA	PROFUNDIDAD MÍN. DE TALADRO	MÍN. ESPESOR MATERIAL BASE	EXTRACCIÓN HORMIGÓN NO-FISURADO	EXTRACCIÓN LADRILLO MACIZO	EXTRACCIÓN LADRILLO HUECO
MEDUB06	6 x 35	6	45	65	8	5	4
MEDUB07	8 x 42	8	50	70	12	5	4
MEDUB08	8 x 50	8	60	80	24	5	4
MEDUB10	10 x 60	10	75	95	70	7	5

IN

Anclaje Indemoll para fijación en elementos huecos

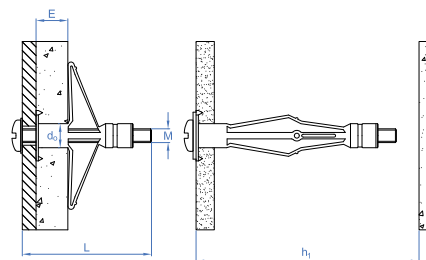

IN-CO

Con tornillo cabeza redonda

CÓDIGO	MXL	Ø BROCA	CAVIDAD MÍNIMA "H"	MÍN. ESPESOR MATERIAL BASE	ESPEOR MÁX. A FIJAR	EXTRACCIÓN CARTÓN YESO	EXTRACCIÓN ESCAYOLA
INCO421	M4 x 30	8	30	1-5	17 -hmin	20	20
INCO432	M4 x 41	8	41	3-10	22 -hmin	20	20
INCO438	M4 x 47	8	47	9-16	30 -hmin	20	20
INCO446	M4 x 53	8	53	15-22	33 -hmin	20	20

CÓDIGO	MXL	Ø BROCA	CAVIDAD MINIMA "H"	MÍN. ESPESOR MATERIAL BASE	ESPESOR MÁX. A FIJAR	EXTRACCIÓN CARTÓN YESO	EXTRACCIÓN ESCAYOLA
INCO459	M4 x 67	8	67	31-36	52 -hmin	20	20
INCO537	M5 x 46	10	46	5-14	26 -hmin	20	25
INCO552	M5 x 59	10	59	6-18	42 -hmin	20	30
INCO565	M5 x 72	10	72	16-33	55 -hmin	20	30
INCO580	M5 x 89	10	89	33-46	61 -hmin	20	30
INCO637	M6 x 46	12	46	5-13	25 -hmin	15	20
INCO652	M6 x 59	12	59	6-17	38 -hmin	20	25
INCO665	M6 x 72	12	72	14-32	49 -hmin	20	25
INCO680	M6 x 89	12	89	34-46	78 -hmin	20	25

IN-HE Con tornillo cabeza hexagonal

CÓDIGO	MXL	Ø BROCA	CAVIDAD MINIMA "H"	MÍN. ESPESOR MATERIAL BASE	ESPESOR MÁX. A FIJAR	EXTRACCIÓN CARTÓN YESO	EXTRACCIÓN ESCAYOLA
INHE837	M8 x 45	14	45	5-13	25 -hmin	20	40
INHE855	M8 x 60	14	60	6-18	36 -hmin	20	40
INHE865	M8 x 73	14	73	17-33	47 -hmin	20	40

BA-NO Basculantes por gravedad para la fijación de elementos ligeros en falsos techos

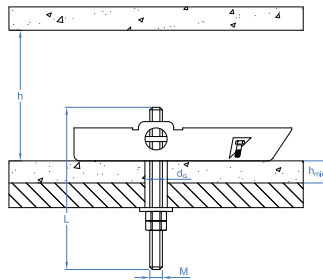

BA-ES Espiga

CÓDIGO	MXL	MAX. ESPESOR CONJUNTO MATERIAL BASE Y ELEMENTO A FIJAR s	Ø BROCA	CAVIDAD MINIMA "H"	EXTRACCIÓN BOVEDILLA DE HORMIGÓN	EXTRACCIÓN CARTÓN YESO	EXTRACCIÓN ESCAYOLA
BAESM04	M4 x 100	74	14	70	10	5	5
BAESM05	M5 x 100	72	14	70	12	5	5
BAESM06	M6 x 100	68	16	75	13	6	6
BAESM08	M8 x 100	60	20	85	14	6	6

BA-GA Gancho

CÓDIGO	MXL	MAX. ESPESOR CONJUNTO MATERIAL BASE Y ELEMENTO A FIJAR s	Ø BROCA	CAVIDAD MINIMA "H"	EXTRACCIÓN BOVEDILLA DE HORMIGÓN	EXTRACCIÓN CARTÓN YESO	EXTRACCIÓN ESCAYOLA
BAGAM04	M4 x 77	74	14	70	10	5	5
BAGAM05	M5 x 80	72	14	70	12	5	5
BAGAM06	M6 x 87	68	16	75	13	6	6
BAGAM08	M8 x 95	60	20	85	14	6	6

PA-LO Palomilla con muelle

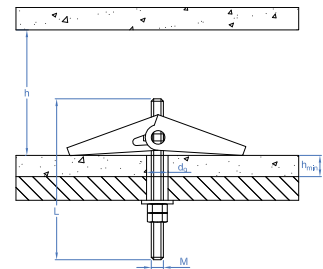

PA-ES Espiga

CÓDIGO	MXL	MAX. ESPESOR CONJUNTO MATERIAL BASE Y ELEMENTO A FIJAR s	Ø BROCA	CAVIDAD MINIMA "H"	EXTRACCIÓN BOVEDILLA DE HORMIGÓN	EXTRACCIÓN CARTÓN YESO	EXTRACCIÓN ESCAYOLA
PAESM04	M4 x 100	75	12	26	10	5	5
PAESM05	M5 x 100	70	15	33	12	5	5
PAESM06	M6 x 100	66	18	37	13	6	6
PAESM08	M8 x 100	61	22	54	14	6	6

PA-GA Gancho

CÓDIGO	MXL	MAX. ESPESOR CONJUNTO MATERIAL BASE Y ELEMENTO A FIJAR s	Ø BROCA	CAVIDAD MINIMA "H"	EXTRACCIÓN BOVEDILLA DE HORMIGÓN	EXTRACCIÓN CARTÓN YESO	EXTRACCIÓN ESCAYOLA
PAGAM04	M4 x 55	75	12	26	10	5	5
PAGAM05	M5 x 65	70	15	33	12	5	5
PAGAM06	M6 x 80	66	18	37	13	6	6
PAGAM08	M8 x 85	61	22	54	14	6	6

CA-QU

Resina de epoxi-acrilato, cuarzo y catalizador.
Homologado ETE Opt. 8

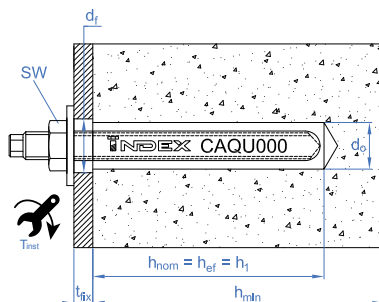

CA-QU

Resina de epoxi-acrilato, cuarzo y catalizador. Homologado ETE Opción 8

CÓDIGO	MXL	ESPESOR MÁX. A FIJAR	Ø BROCA	PROFUNDIDAD MÍN. DE TALADRO	PROFUNDIDAD MÍN. DEL ANCLAJE	LLAVE DE INSTALACIÓN	PAR DE APRIETE (NM)	Ø ELEMENTO A FIJAR	MÍN. ESPESOR MATERIAL BASE	DISTANCIA MÍN. AL BORDE "A"	DISTANCIA MÍN. ENTRE EJES "B"	EXTRACCIÓN HORMIGÓN NO-FISURADO	CIZALLADURA HORMIGÓN NO-FISURADO
CAQU008	8 Ø9 / 17	17	10	80	80	13	10	9	110	120	240	809	524
CAQU010	10 Ø11 / 25	25	12	90	90	17	20	12	120	90	180	1214	815
CAQU012	12 Ø13 / 32	32	14	110	110	19	40	14	140	110	220	1618	1223
CAQU016	16 Ø17 / 44	44	18	125	125	24	80	18	160	125	250	2023	2272
CAQU020	20 Ø22 / 66	66	25	170	170	30	120	22	220	170	340	3034	3553
CAQU024	24 Ø24 / 62	62	28	210	210	36	180	26	260	210	420	3641	5126
CAQU030	30 Ø33 / 22	22	35	280	280	46	400	33	360	280	560	5461	8496

MTH

Anclaje macho para cargas altas en hormigón no fisurado

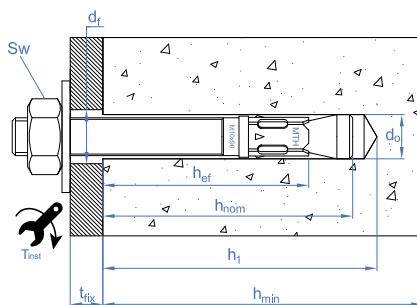

MTH

Homologado ETE Opt.7. Eje cincado. Clip cincado

CÓDIGO	MXL	ESPESOR MÁX. A FIJAR	Ø BROCA	PROFUNDIDAD MÍN. DE TALADRO	PROFUNDIDAD MÍN. DEL ANCLAJE	LLAVE DE INSTALACIÓN	PAR DE APRIETE (NM)	LETRA EJE	Ø ELEMENTO A FIJAR	MÍN. ESPESOR MATERIAL BASE	DISTANCIA MÍN. AL BORDE "A"	DISTANCIA MÍN. ENTRE EJES "B"	EXTRACCIÓN HORMIGÓN NO-FISURADO	CIZALLADURA HORMIGÓN NO-FISURADO
AH06060	M6 x 60	2	6	55	50	10	7	B	7	100	60	120	385	297
AH06070	M6 x 70	12	6	55	50	10	7	C	7	100	60	120	385	297
AH06080	M6 x 80	22	6	55	50	10	7	D	7	100	60	120	385	297
AH06090	M6 x 90	32	6	55	50	10	7	E	7	100	60	120	385	297
AH06100	M6 x 100	42	6	55	50	10	7	E	7	100	60	120	385	297
AH06110	M6 x 110	52	6	55	50	10	7	F	7	100	60	120	385	297
AH06120	M6 x 120	62	6	55	50	10	7	G	7	100	60	120	385	297
AH06130	M6 x 130	72	6	55	50	10	7	H	7	100	60	120	385	297
AH06140	M6 x 140	82	6	55	50	10	7	I	7	100	60	120	385	297
AH06150	M6 x 150	92	6	55	50	10	7	I	7	100	60	120	385	297
AH06160	M6 x 160	102	6	55	50	10	7	J	7	100	60	120	385	297
AH06170	M6 x 170	112	6	55	50	10	7	K	7	100	60	120	385	297
AH06180	M6 x 180	122	6	55	50	10	7	L	7	100	60	120	385	297
AH08060	M8 x 60	3	8	50	50	13	20	B	9	100	53	105	485	494
AH08075	M8 x 75	5	8	65	60	13	20	C	9	100	72	144	676	542
AH08090	M8 x 90	20	8	65	60	13	20	E	9	100	72	144	676	542
AH08100	M8 x 100	30	8	65	60	13	20	E	9	100	72	144	676	542
AH08115	M8 x 115	45	8	65	60	13	20	G	9	100	72	144	676	542
AH08120	M8 x 120	50	8	65	60	13	20	G	9	100	72	144	676	542
AH08130	M8 x 130	60	8	65	60	13	20	H	9	100	72	144	676	542
AH08155	M8 x 155	85	8	65	60	13	20	J	9	100	72	144	676	542
AH10070	M10 x 70	3	10	60	54	17	35	C	12	100	63	126	650	650
AH10080	M10 x 80	13	10	60	54	17	35	D	12	100	63	126	650	650
AH10090	M10 x 90	10	10	75	67	17	35	E	12	110	83	165	922	856
AH10100	M10 x 100	20	10	75	67	17	35	E	12	110	83	165	922	856
AH10120	M10 x 120	40	10	75	67	17	35	G	12	110	83	165	922	856
AH10140	M10 x 140	60	10	75	67	17	35	H	12	110	83	165	922	856
AH10150	M10 x 150	70	10	75	67	17	35	I	12	110	83	165	922	856
AH10160	M10 x 160	80	10	75	67	17	35	J	12	110	83	165	922	856
AH10170	M10 x 170	90	10	75	67	17	35	K	12	110	83	165	922	856
AH10210	M10 x 210	130	10	75	67	17	35	N	12	110	83	165	922	856
AH10230	M10 x 230	150	10	75	67	17	35	P	12	110	83	165	922	856
AH12090	M12 x 90	13	12	70	60	19	60	E	14	100	75	150	844	844

CÓDIGO	MXL	ESPESOR MÁX. A FIJAR	Ø BROCA	PROFUNDIDAD MÍN. DE TALADRO	PROFUNDIDAD MÍN. DEL ANCLAJE	LLAVE DE INSTALACIÓN	PAR DE APRIETE (NM)	LETRA EJE	Ø ELEMENTO A FIJAR	MÍN. ESPESOR MATERIAL BASE	DISTANCIA MÍN. AL BORDE "A"	DISTANCIA MÍN. ENTRE EJES "B"	EXTRACCIÓN HORMIGÓN NO-FISURADO	CIZALLADURA HORMIGÓN NO-FISURADO
AH12100	M12 x 100	8	12	85	77	19	60	E	14	130	75	150	1251	1200
AH12110	M12 x 110	18	12	85	77	19	60	F	14	130	98	195	1251	1200
AH12120	M12 x 120	28	12	85	77	19	60	G	14	130	98	195	1251	1200
AH12130	M12 x 130	38	12	85	77	19	60	H	14	130	98	195	1251	1200
AH12140	M12 x 140	48	12	85	77	19	60	H	14	130	98	195	1251	1200
AH12160	M12 x 160	68	12	85	77	19	60	J	14	130	98	195	1251	1200
AH12180	M12 x 180	88	12	85	77	19	60	L	14	130	98	195	1251	1200
AH12200	M12 x 200	108	12	85	77	19	60	M	14	130	98	195	1251	1200
AH12220	M12 x 220	128	12	85	77	19	60	O	14	130	98	195	1251	1200
AH12250	M12 x 250	158	12	85	77	19	60	Q	14	130	98	195	1251	1200
AH14120	M14 x 120	12	14	100	91	22	90	G	16	150	113	225	1551	1637
AH14145	M14 x 145	37	14	100	91	22	90	I	16	150	113	225	1551	1637
AH14170	M14 x 170	62	14	100	91	22	90	K	16	150	113	225	1551	1637
AH14220	M14 x 220	112	14	100	91	22	90	O	16	150	113	225	1551	1637
AH14250	M14 x 250	142	14	100	91	22	90	Q	16	150	113	225	1551	1637
AH16125	M16 x 125	3	16	110	104	24	120	G	18	168	126	252	1887	2237
AH16145	M16 x 145	23	16	110	104	24	120	I	18	168	126	252	1887	2237
AH16170	M16 x 170	48	16	110	104	24	120	K	18	168	126	252	1887	2237
AH16220	M16 x 220	98	16	110	104	24	120	O	18	168	126	252	1887	2237
AH16250	M16 x 250	128	16	110	104	24	120	Q	18	168	126	252	1887	2237
AH16280	M16 x 280	158	16	110	104	24	120	S	18	168	126	252	1887	2237
AH20170	M20 x 170	23	20	135	125	30	240	K	22	206	155	309	2496	3279
AH20220	M20 x 220	73	20	135	125	30	240	O	22	206	155	309	2496	3279
AH20270	M20 x 270	123	20	135	125	30	240	S	22	206	155	309	2496	3279

MTH-A4

Homologado ETE Opt.7. Eje Inoxidable A4. Clip Inoxidable A4

CÓDIGO	MXL	ESPESOR MÁX. A FIJAR	Ø BROCA	PROFUNDIDAD MÍN. DE TALADRO	PROFUNDIDAD MÍN. DEL ANCLAJE	LLAVE DE INSTALACIÓN	PAR DE APRIETE (NM)	LETRA EJE	Ø ELEMENTO A FIJAR	MÍN. ESPESOR MATERIAL BASE	DISTANCIA MÍN. AL BORDE "A"	DISTANCIA MÍN. ENTRE EJES "B"	EXTRACCIÓN HORMIGÓN NO-FISURADO	CIZALLADURA HORMIGÓN NO-FISURADO
MIA406045	M6 x 45	1	6	40	35	10	7	A	7	100	40	75	298	287
MIA406060	M6 x 60	2	6	55	50	10	7	B	7	100	60	120	438	287
MIA406080	M6 x 80	22	6	55	50	10	7	D	7	100	60	120	438	287
MIA408050	M8 x 50	4	8	40	35	13	20	A	9	100	40	75	219	263
MIA408075	M8 x 75	5	8	65	60	13	20	C	9	100	72	144	582	522
MIA408090	M8 x 90	20	8	65	60	13	20	E	9	100	72	144	582	522
MIA408115	M8 x 115	45	8	65	60	13	20	G	9	100	72	144	582	522
MIA410070	M10 x 70	3	10	60	54	17	35	C	12	100	60	120	485	650
MIA410090	M10 x 90	10	10	75	67	17	35	E	12	110	83	165	647	834
MIA410120	M10 x 120	40	10	75	67	17	35	G	12	110	83	165	647	834
MIA410150	M10 x 150	70	10	75	67	17	35	I	12	110	83	165	647	834
MIA412075	M12 x 75	5	12	60	55	19	60	C	14	100	65	130	561	673
MIA412090	M12 x 90	13	12	70	62	19	60	D	14	100	75	90	647	844
MIA412110	M12 x 110	12	12	85	77	19	60	F	14	130	98	195	1011	1207
MIA412140	M12 x 140	42	12	85	77	19	60	I	14	130	98	195	1011	1207
MIA416090	M16 x 90	4	16	75	69	24	120	D	18	100	75	150	683	819
MIA416145	M16 x 145	23	16	110	104	24	120	I	18	168	126	252	1416	2256
MIA416170	M16 x 170	48	16	110	104	24	120	K	18	168	126	252	1416	2256
MIA420120	M20 x 120	5	20	105	93	30	240	G	22	145	110	225	1190	2857
MIA420170	M20 x 170	23	20	135	125	30	240	K	22	206	155	309	2023	3521
MIA420220	M20 x 220	73	20	135	125	30	240	O	22	206	155	309	2023	3521

MTH-A2

Homologado ETE Opt.7. Eje Inoxidable A2. Clip Inoxidable A2

CÓDIGO	MXL	ESPESOR MÁX. A FIJAR	Ø BROCA	PROFUNDIDAD MÍN. DE TALADRO	PROFUNDIDAD MÍN. DEL ANCLAJE	LLAVE DE INSTALACIÓN	PAR DE APRIETE (NM)	LETRA EJE	Ø ELEMENTO A FIJAR	MÍN. ESPESOR MATERIAL BASE	DISTANCIA MÍN. AL BORDE "A"	DISTANCIA MÍN. ENTRE EJES "B"	EXTRACCIÓN HORMIGÓN NO-FISURADO	CIZALLADURA HORMIGÓN NO-FISURADO
MIO6045	M6 x 45	1	6	40	35	10	7	A	7	100	40	75	298	287
MIO6060	M6 x 60	2	6	55	50	10	7	B	7	100	60	120	438	287
MIO6080	M6 x 80	22	6	55	50	10	7	D	7	100	60	120	438	287
MIO6120	M6 x 120	62	6	55	50	10	7	G	7	100	60	120	438	287
MIO6140	M6 x 140	82	6	55	50	10	7	I	7	100	60	120	438	287
MIO6160	M6 x 160	102	6	55	50	10	7	J	7	100	60	120	438	287
MIO6170	M6 x 170	112	6	55	50	10	7	K	7	100	60	120	438	287
MIO6180	M6 x 180	122	6	55	50	10	7	L	7	100	60	120	438	287
MIO8050	M8 x 50	4	8	40	35	13	20	A	9	100	40	75	219	263
MIO8075	M8 x 75	5	8	65	60	13	20	C	9	100	72	144	582	522
MIO8090	M8 x 90	20	8	65	60	13	20	E	9	100	72	144	582	522
MIO8115	M8 x 115	45	8	65	60	13	20	G	9	100	72	144	582	522
MI10070	M10 x 70	3	10	60	54	17	35	C	12	100	60	120	485	650
MI10090	M10 x 90	10	10	75	67	17	35	E	12	110	83	165	647	834
MI10120	M10 x 120	40	10	75	67	17	35	G	12	110	83	165	647	834
MI10150	M10 x 150	70	10	75	67	17	35	I	12	110	83	165	647	834
MI12075	M12 x 75	5	12	60	55	19	60	C	14	100	65	130	561	672
MI12090	M12 x 90	13	12	70	62	19	60	D	14	120	75	150	647	844
MI12110	M12 x 110	18	12	85	77	19	60	F	14	130	98	195	1011	1207
MI12140	M12 x 140	48	12	85	77	19	60	I	14	130	98	195	1011	1207
MI16090	M16 x 90	4	16	75	69	24	120	D	18	100	75	150	683	819
MI16145	M16 x 145	23	16	110	104	24	120	I	18	168	126	252	1416	2256
MI16170	M16 x 170	48	16	110	104	24	120	K	18	168	126	252	1416	2256
MI20120	M20 x 120	5	20	105	93	30	240	G	22	145	110	225	1190	2857
MI20170	M20 x 170	23	20	135	125	30	240	K	22	206	155	309	2023	3521
MI20220	M20 x 220	73	20	135	125	30	240	O	22	206	155	309	2023	3521

MTA

Anclaje macho para cargas altas

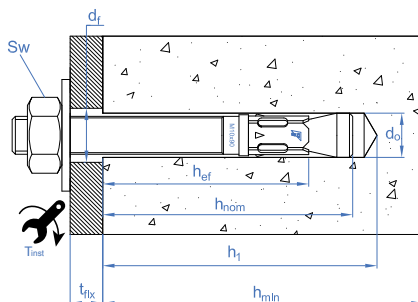

MTA

Eje cincado. Clip cincado

CÓDIGO	MXL	ESPESOR MÁX. A FIJAR	Ø BROCA	PROFUNDIDAD MIN. DE TALADRO	PROFUNDIDAD MIN. DEL ANCLAJE	LLAVE DE INSTALACIÓN	PAR DE APRIETE (NM)	Ø ELEMENTO A FIJAR	MÍN. ESPESOR MATERIAL BASE	DISTANCIA MIN. AL BORDE "A"	DISTANCIA MIN. ENTRE EJES "B"	EXTRACCIÓN HORMIGÓN NO-FISURADO	CIZALLADURA HORMIGÓN NO-FISURADO
AM06045	M6 x 45	1	6	40	35	10	7	7	100	40	75	298	297
AM06055	M6 x 55	11	6	40	35	10	7	7	100	40	75	298	297
AM06060	M6 x 60	2	6	55	50	10	7	7	100	60	120	385	297
AM06065	M6 x 65	7	6	55	50	10	7	7	100	60	120	385	297
AM06070	M6 x 70	12	6	55	50	10	7	7	100	60	120	385	297
AM06080	M6 x 80	22	6	55	50	10	7	7	100	60	120	385	297
AM06085	M6 x 85	27	6	55	50	10	7	7	100	60	120	385	297
AM06090	M6 x 90	32	6	55	50	10	7	7	100	60	120	385	297
AM06100	M6 x 100	42	6	55	50	10	7	7	100	60	120	385	297
AM06110	M6 x 110	52	6	55	50	10	7	7	100	60	120	385	297
AM06120	M6 x 120	62	6	55	50	10	7	7	100	60	120	385	297
AM06130	M6 x 130	72	6	55	50	10	7	7	100	60	120	385	297
AM06140	M6 x 140	82	6	55	50	10	7	7	100	60	120	385	297
AM06150	M6 x 150	92	6	55	50	10	7	7	100	60	120	385	297
AM06160	M6 x 160	102	6	55	50	10	7	7	100	60	120	385	297
AM06170	M6 x 170	112	6	55	50	10	7	7	100	60	120	385	297
AM06180	M6 x 180	122	6	55	50	10	7	7	100	60	120	385	297
AM08050	M8 x 50	4	8	40	35	13	20	9	100	40	75	263	263
AM08060	M8 x 60	3	8	50	47	13	20	9	100	53	105	485	494
AM08065	M8 x 65	8	8	50	47	13	20	9	100	53	105	485	494
AM08075	M8 x 75	5	8	65	60	13	20	9	100	72	144	676	542
AM08090	M8 x 90	20	8	65	60	13	20	9	100	72	144	676	542
AM08115	M8 x 115	45	8	65	60	13	20	9	100	72	144	676	542
AM08120	M8 x 120	50	8	65	60	13	20	9	100	72	144	676	542
AM08130	M8 x 130	60	8	65	60	13	20	9	100	72	144	676	542
AM08155	M8 x 155	85	8	65	60	13	20	9	100	72	144	676	542
AM10065	M10 x 65	1	10	55	52	17	35	12	100	60	120	604	604
AM10070	M10 x 70	3	10	60	54	17	35	12	100	63	125	650	650
AM10080	M10 x 80	13	10	60	54	17	35	12	100	63	125	667	667
AM10090	M10 x 90	10	10	75	67	17	35	12	110	83	165	922	856
AM10100	M10 x 100	20	10	75	67	17	35	12	110	83	165	922	856
AM10120	M10 x 120	40	10	75	67	17	35	12	110	83	165	922	856
AM10140	M10 x 140	60	10	75	67	17	35	12	110	83	165	922	856
AM10150	M10 x 150	70	10	75	67	17	35	12	110	83	165	922	856
AM10160	M10 x 160	80	10	75	67	17	35	12	110	83	165	922	856
AM10170	M10 x 170	90	10	75	67	17	35	12	110	83	165	922	856
AM10210	M10 x 210	130	10	75	67	17	35	12	110	83	165	922	856
AM10230	M10 x 230	150	10	75	67	17	35	12	110	83	165	922	856
AM12075	M12 x 75	5	12	60	55	19	60	14	100	65	130	673	673
AM12080	M12 x 80	3	12	70	62	19	60	14	100	75	150	844	844
AM12090	M12 x 90	13	12	70	62	19	60	14	100	75	150	844	844
AM12100	M12 x 100	8	12	85	77	19	60	14	130	98	195	1251	1200
AM12110	M12 x 110	18	12	85	77	19	60	14	130	98	195	1251	1200
AM12120	M12 x 120	28	12	85	77	19	60	14	130	98	195	1251	1200
AM12140	M12 x 140	48	12	85	77	19	60	14	130	98	195	1251	1200
AM12160	M12 x 160	68	12	85	77	19	60	14	130	98	195	1251	1200
AM12180	M12 x 180	88	12	85	77	19	60	14	130	98	195	1251	1200
AM12220	M12 x 220	128	12	85	77	19	60	14	130	98	195	1251	1200
AM12250	M12 x 250	158	12	85	77	19	60	14	130	98	195	1251	1200
AM14080	M14 x 80	5	14	65	59	22	90	16	100	65	130	650	650
AM14100	M14 x 100	5	14	85	69	22	90	16	125	95	190	1166	1637
AM14120	M14 x 120	12	14	100	91	22	90	16	150	113	225	1551	1637
AM14145	M14 x 145	37	14	100	91	22	90	16	150	113	225	1551	1637
AM14170	M14 x 170	62	14	100	91	22	90	16	150	113	225	1551	1637
AM14220	M14 x 220	112	14	100	91	22	90	16	150	113	225	1551	1637
AM14250	M14 x 250	142	14	100	91	22	90	16	150	113	225	1551	1637
AM16090	M16 x 90	4	16	75	69	24	120	18	100	75	150	819	819
AM16110	M16 x 110	7	16	75	69	24	120	18	100	75	150	838	2237
AM16125	M16 x 125	3	16	110	104	24	120	18	168	126	252	1838	2237
AM16145	M16 x 145	23	16	110	104	24	120	18	168	126	252	1838	2237
AM16170	M16 x 170	48	16	110	104	24	120	18	168	126	252	1838	2237
AM16220	M16 x 220	98	16	110	104	24	120	18	168	126	252	1838	2237
AM16250	M16 x 250	128	16	110	104	24	120	18	168	126	252	1838	2237

CÓDIGO	MXL	ESPESOR MÁX. A FIJAR	Ø BROCA	PROFUNDIDAD MIN. DE TALADRO	PROFUNDIDAD MIN. DEL ANCLAJE	LLAVE DE INSTALACIÓN	PAR DE APRIETE (NM)	Ø ELEMENTO A FIJAR	MÍN. ESPESOR MATERIAL BASE	DISTANCIA MIN. AL BORDE "A"	DISTANCIA MIN. ENTRE EJES "B"	EXTRACCIÓN HORMIGÓN NO-FISURADO	CIZALLADURA HORMIGÓN NO-FISURADO
AM16280	M16 x 280	158	16	110	104	24	120	18	168	126	252	1838	2237
AM20120	M20 x 120	5	20	105	93	30	240	22	145	110	225	1429	2857
AM20170	M20 x 170	23	20	135	125	30	240	22	206	155	309	2496	3279
AM20220	M20 x 220	73	20	135	125	30	240	22	206	155	309	2496	3279
AM20270	M20 x 270	123	20	135	125	30	240	22	206	155	309	2496	3279
AM24180	M24 x 180	10	24	155	143	36	250	26	250	200	400	2023	4934
AM24260	M24 x 260	80	24	155	143	36	250	26	250	200	400	2023	4934

TH

Anclaje de fijación directa en hormigón

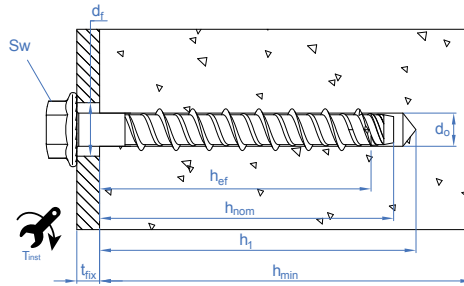

THE

Homologado ETE Opt.1. Cabeza hexagonal con recubrimiento ATLANTIS C3-H

CÓDIGO	MXL	LONGITUD	Ø BROCA	PROFUNDIDAD MIN. DE TALADRO	MÍN. ESPESOR MATERIAL BASE	Ø ELEMENTO A FIJAR	PROFUNDIDAD MIN. DEL ANCLAJE	ESPESOR MÁX. A FIJAR	PAR DE APRIETE (NM)	DISTANCIA MIN. AL BORDE "A"	DISTANCIA MIN. ENTRE EJES "B"	LLAVE DE INSTALACIÓN	EXTRACCIÓN HORMIGÓN NO-FISURADO	CIZALLADURA HORMIGÓN NO-FISURADO	EXTRACCIÓN HORMIGÓN FISURADO	CIZALLADURA HORMIGÓN FISURADO
THE05040	Ø5 x 40	40	5	45	80	8	35	5	8	40	80	8	326	326	228	228
THE05050	Ø5 x 50	50	5	55	80	8	45	5	8	53	105	8	494	398	346	346
THE05060	Ø5 x 60	60	5	55	80	8	45	15	8	53	105	8	494	398	346	346
THE05080	Ø5 x 80	80	5	55	80	8	45	35	8	53	105	8	494	398	346	346
THE05100	Ø5 x 100	100	5	55	80	8	45	55	8	53	105	8	494	398	346	346
THE06040	Ø6 x 40	40	6	45	100	9	35	5	10	39	78	10	202	608	185	454
THE06050	Ø6 x 50	50	6	45	100	9	35	15	10	39	78	10	202	608	185	454
THE06060	Ø6 x 60	60	6	65	100	9	55	5	10	65	129	10	673	608	471	542
THE06070	Ø6 x 70	70	6	65	100	9	55	15	10	65	129	10	673	608	471	542
THE06080	Ø6 x 80	80	6	65	100	9	55	25	10	65	129	10	673	608	471	542
THE06100	Ø6 x 100	100	6	65	100	9	55	45	10	65	129	10	673	608	471	542
THE06120	Ø6 x 120	120	6	65	100	9	55	65	10	65	129	10	673	608	471	542
THE08055	Ø8 x 55	55	8	60	100	12	50	5	20	57	113	13	457	950	320	691
THE08060	Ø8 x 60	60	8	60	100	12	50	10	20	57	113	13	457	950	320	691
THE08070	Ø8 x 70	70	8	75	100	12	65	5	20	76	152	13	857	950	600	762
THE08080	Ø8 x 80	80	8	75	100	12	65	15	20	76	152	13	857	950	600	762
THE08090	Ø8 x 90	90	8	75	100	12	65	25	20	76	152	13	857	950	600	762
THE08100	Ø8 x 100	100	8	75	100	12	65	35	20	76	152	13	857	950	600	762
THE08110	Ø8 x 110	110	8	75	100	12	65	45	20	76	152	13	857	950	600	762
THE08120	Ø8 x 120	120	8	75	100	12	65	55	20	76	152	13	857	950	600	762
THE08140	Ø8 x 140	140	8	75	100	12	65	75	20	76	152	13	857	950	600	762
THE10060	Ø10 x 60	60	10	65	100	14	55	5	30	63	125	15	638	1245	447	871
THE10070	Ø10 x 70	70	10	65	100	14	55	15	30	63	125	15	638	1245	447	871
THE10080	Ø10 x 80	80	10	65	100	14	55	25	30	63	125	15	638	1245	447	871
THE10090	Ø10 x 90	90	10	95	135	14	85	5	30	101	201	15	1310	1330	917	1330
THE10100	Ø10 x 100	100	10	95	135	14	85	15	30	101	201	15	1310	1330	917	1330
THE10120	Ø10 x 120	120	10	95	135	14	85	35	30	101	201	15	1310	1330	917	1330
THE10140	Ø10 x 140	140	10	95	135	14	85	55	30	101	201	15	1310	1330	917	1330
THE12080	Ø12 x 80	80	12	90	120	16	75	5	50	87	174	18	1055	1808	738	1720
THE12090	Ø12 x 90	90	12	90	120	16	75	15	50	87	174	18	1055	1808	738	1720
THE12110	Ø12 x 110	110	12	120	170	16	105	5	50	126	251	18	1822	1808	1275	1808
THE12130	Ø12 x 130	130	12	120	170	16	105	25	50	126	251	18	1822	1808	1275	1808
THE12150	Ø12 x 150	150	12	120	170	16	105	45	50	126	251	18	1822	1808	1275	1808
THE14080	Ø14 x 80	80	14	90	120	18	75	5	70	87	174	21	1055	2559	738	1883
THE14100	Ø14 x 100	100	14	90	120	18	75	25	70	87	174	21	1055	2559	738	1883
THE14120	Ø14 x 120	120	14	130	185	18	115	5	70	138	276	21	2107	2559	1475	2559
THE14130	Ø14 x 130	130	14	130	185	18	115	15	70	138	276	21	2107	2559	1475	2559
THE14140	Ø14 x 140	140	14	130	185	18	115	25	70	138	276	21	2107	2559	1475	2559
THE14160	Ø14 x 160	160	14	130	185	18	115	45	70	138	276	21	2107	2559	1475	2559
THE16100	Ø16 x 100	100	-	-	-	-	-	-	-	-	-	-	-	-	-	-
THE16150	Ø16 x 150	150	-	-	-	-	-	-	-	-	-	-	-	-	-	-
THE18100	Ø18 x 100	100	18	110	140	22	90	10	90	105	209	24	1384	3680	968	2576
THE18130	Ø18 x 130	130	18	110	140	22	90	40	90	105	209	24	1384	3680	968	2576
THE18160	Ø18 x 160	160	18	160	225	22	140	20	90	168	336	24	2830	3921	1981	3921
THE18180	Ø18 x 180	180	18	160	225	22	140	40	90	168	336	24	2830	3921	1981	3921
THE18200	Ø18 x 200	200	18	160	225	22	140	60	90	168	336	24	2830	3921	1981	3921

THA

Homologado ETE Opt.1. Cabeza avellanada con recubrimiento ATLANTIS C3-H

CÓDIGO	MXL	LONGITUD	Ø BROCA	PROFUNDIDAD MIN. DE TALADRO	MÍN. ESPESOR MATERIAL BASE	Ø ELEMENTO A FIJAR	PROFUNDIDAD MIN. DEL ANCLAJE	ESPESOR MÁX. A FIJAR	PAR DE APRIETE (NM)	DISTANCIA MIN. AL BORDE "A"	DISTANCIA MIN. ENTRE EJES "B"	LLAVE DE INSTALACIÓN	EXTRACCIÓN HORMIGÓN NO-FISURADO	CIZALLADURA HORMIGÓN NO-FISURADO	EXTRACCIÓN HORMIGÓN FISURADO	CIZALLADURA HORMIGÓN FISURADO
THA05040	Ø5 x 40	40	5	45	80	8	35	5	8	40	80	TX25	326	326	228	228
THA05060	Ø5 x 60	60	5	55	80	8	45	15	8	53	105	TX25	494	398	346	346
THA05080	Ø5 x 80	80	5	55	80	8	45	35	8	53	105	TX25	494	398	346	346

CÓDIGO	MXL	LONGITUD	Ø BROCA	PROFUNDIDAD MÍN. DE TALADRO	MÍN. ESPESOR MATERIAL BASE	Ø ELEMENTO A FIJAR	PROFUNDIDAD MÍN. DEL ANCLAJE	ESPEOR MÁX. A FIJAR	PAR DE APRIETE (NM)	DISTANCIA MÍN. AL BORDE "A"	DISTANCIA MÍN. ENTRE EJES "B"	LLAVE DE INSTALACIÓN	EXTRACCIÓN HORMIGÓN NO-FISURADO	CIZALLADURA HORMIGÓN NO-FISURADO	EXTRACCIÓN HORMIGÓN FISURADO	CIZALLADURA HORMIGÓN FISURADO
THA05100	Ø5 x 100	100	5	55	80	8	45	55	8	53	105	TX25	494	398	346	346
THA06045	Ø6 x 45	45	6	45	100	9	35	10	10	39	78	TX30	202	608	185	454
THA06050	Ø6 x 50	50	6	45	100	9	35	15	10	39	78	TX30	202	608	185	454
THA06060	Ø6 x 60	60	6	65	100	9	55	5	10	65	129	TX30	673	608	471	542
THA06080	Ø6 x 80	80	6	65	100	9	55	25	10	65	129	TX30	673	608	471	542
THA06120	Ø6 x 120	120	6	65	100	9	55	65	10	65	129	TX30	673	608	471	542
THA06140	Ø6 x 140	140	6	65	100	9	55	85	10	65	129	TX30	673	608	471	542
THA08060	Ø8 x 60	60	8	60	100	12	50	10	20	57	113	TX45	457	950	320	691
THA08080	Ø8 x 80	80	8	75	100	12	65	15	20	76	152	TX45	857	950	600	762
THA08100	Ø8 x 100	100	8	75	100	12	65	35	20	76	152	TX45	857	950	600	762
THA08120	Ø8 x 120	120	8	75	100	12	65	55	20	76	152	TX45	857	950	600	762
THA10100	Ø10 x 100	100	10	95	135	14	85	15	30	101	201	TX50	1310	1330	600	762
THA10120	Ø10 x 120	120	10	95	135	14	85	35	30	101	201	TX50	1310	1330	600	762

THP Homologado ETE Opt.1. Cabeza alomada con recubrimiento ATLANTIS C3-H

CÓDIGO	MXL	LONGITUD	Ø BROCA	PROFUNDIDAD MÍN. DE TALADRO	MÍN. ESPESOR MATERIAL BASE	Ø ELEMENTO A FIJAR	PROFUNDIDAD MÍN. DEL ANCLAJE	ESPEOR MÁX. A FIJAR	PAR DE APRIETE (NM)	DISTANCIA MÍN. AL BORDE "A"	DISTANCIA MÍN. ENTRE EJES "B"	LLAVE DE INSTALACIÓN	EXTRACCIÓN HORMIGÓN NO-FISURADO	CIZALLADURA HORMIGÓN NO-FISURADO	EXTRACCIÓN HORMIGÓN FISURADO	CIZALLADURA HORMIGÓN FISURADO
THP05040	Ø5 x 40	40	5	45	80	8	35	5	8	40	80	TX30	326	326	228	228
THP05060	Ø5 x 60	60	5	65	80	8	55	15	8	53	105	TX30	494	398	346	346
THP06040	Ø6 x 40	40	6	45	100	9	35	5	10	39	78	TX40	202	608	185	454
THP06050	Ø6 x 50	50	6	45	100	9	35	15	10	39	78	TX40	202	608	185	454
THP06060	Ø6 x 60	60	6	65	100	9	55	5	10	65	129	TX40	673	608	471	542
THP06080	Ø6 x 80	80	6	65	100	9	55	25	10	65	129	TX40	673	608	471	542
THP06100	Ø6 x 100	100	6	65	100	9	55	45	10	65	129	TX40	673	608	471	542
THP08060	Ø8 x 60	60	8	60	100	12	50	10	20	57	113	TX45	457	950	320	691
THP08080	Ø8 x 80	80	8	75	100	12	65	15	20	76	152	TX45	857	950	600	762

THT Homologado ETE Opt.1. Cabeza Truss con recubrimiento ATLANTIS C3-H

CÓDIGO	MXL	LONGITUD	Ø BROCA	PROFUNDIDAD MÍN. DE TALADRO	MÍN. ESPESOR MATERIAL BASE	Ø ELEMENTO A FIJAR	PROFUNDIDAD MÍN. DEL ANCLAJE	ESPEOR MÁX. A FIJAR	PAR DE APRIETE (NM)	DISTANCIA MÍN. AL BORDE "A"	DISTANCIA MÍN. ENTRE EJES "B"	LLAVE DE INSTALACIÓN	EXTRACCIÓN HORMIGÓN NO-FISURADO	CIZALLADURA HORMIGÓN NO-FISURADO	EXTRACCIÓN HORMIGÓN FISURADO	CIZALLADURA HORMIGÓN FISURADO
THT06040	Ø6 x 40	40	6	45	100	9	35	5	10	39	78	TX30	202	608	185	454
THT06050	Ø6 x 50	50	6	45	100	9	35	15	10	39	78	TX30	202	608	185	454
THT06060	Ø6 x 60	60	6	65	100	9	55	5	10	65	129	TX30	673	608	471	542

TFE Homologado ETE Opt.1. Cabeza hexagonal con recubrimiento cincado

CÓDIGO	MXL	LONGITUD	Ø BROCA	PROFUNDIDAD MÍN. DE TALADRO	MÍN. ESPESOR MATERIAL BASE	Ø ELEMENTO A FIJAR	PROFUNDIDAD MÍN. DEL ANCLAJE	ESPEOR MÁX. A FIJAR	PAR DE APRIETE (NM)	DISTANCIA MÍN. AL BORDE "A"	DISTANCIA MÍN. ENTRE EJES "B"	LLAVE DE INSTALACIÓN	EXTRACCIÓN HORMIGÓN NO-FISURADO	CIZALLADURA HORMIGÓN NO-FISURADO	EXTRACCIÓN HORMIGÓN FISURADO	CIZALLADURA HORMIGÓN FISURADO
TFE05040	Ø5 x 40	40	5	45	80	8	35	5	8	40	80	8	326	326	228	228
TFE05050	Ø5 x 50	50	5	55	80	8	45	5	8	53	105	8	494	398	346	346
TFE05060	Ø5 x 60	60	5	55	80	8	45	15	8	53	105	8	494	398	346	346
TFE05080	Ø5 x 80	80	5	55	80	8	45	35	8	53	105	8	494	398	346	346
TFE05100	Ø5 x 100	100	5	55	80	8	45	55	8	53	105	8	494	398	346	346
TFE06040	Ø6 x 40	40	6	45	100	9	35	5	10	39	78	10	202	608	185	454
TFE06050	Ø6 x 50	50	6	45	100	9	35	15	10	39	78	10	202	608	185	454
TFE06060	Ø6 x 60	60	6	65	100	9	55	5	10	65	129	10	673	608	471	542
TFE06070	Ø6 x 70	70	6	65	100	9	55	15	10	65	129	10	673	608	471	542
TFE06080	Ø6 x 80	80	6	65	100	9	55	25	10	65	129	10	673	608	471	542
TFE06100	Ø6 x 100	100	6	65	100	9	55	45	10	65	129	10	673	608	471	542
TFE06120	Ø6 x 120	120	6	65	100	9	55	65	10	65	129	10	673	608	471	542
TFE08055	Ø8 x 55	55	8	60	100	12	50	5	20	57	113	13	457	950	320	691
TFE08060	Ø8 x 60	60	8	60	100	12	50	10	20	57	113	13	457	950	320	691
TFE08070	Ø8 x 70	70	8	75	100	12	65	5	20	76	152	13	857	950	600	762
TFE08080	Ø8 x 80	80	8	75	100	12	65	15	20	76	152	13	857	950	600	762
TFE08090	Ø8 x 90	90	8	75	100	12	65	25	20	76	152	13	857	950	600	762
TFE08100	Ø8 x 100	100	8	75	100	12	65	35	20	76	152	13	857	950	600	762
TFE08110	Ø8 x 110	110	8	75	100	12	65	45	20	76	152	13	857	950	600	762
TFE08120	Ø8 x 120	120	8	75	100	12	65	55	20	76	152	13	857	950	600	762
TFE08140	Ø8 x 140	140	8	75	100	12	65	75	20	76	152	13	857	950	600	762
TFE10060	Ø10 x 60	60	10	65	100	14	55	5	30	63	125	15	638	1245	447	871
TFE10070	Ø10 x 70	70	10	65	100	14	55	15	30	63	125	15	638	1245	447	871
TFE10080	Ø10 x 80	80	10	85	120	14	75	25	30	88	176	15	638	1245	447	871
TFE10090	Ø10 x 90	90	10	95	135	14	85	5	30	101	201	15	1310	1330	917	1330
TFE10100	Ø10 x 100	100	10	95	135	14	85	15	30	101	201	15	1310	1330	917	1330
TFE10120	Ø10 x 120	120	10	95	135	14	85	35	30	101	201	15	1310	1330	917	1330
TFE10140	Ø10 x 140	140	10	95	135	14	85	55	30	101	201	15	1310	1330	917	1330
TFE12080	Ø12 x 80	80	12	90	120	16	75	5	50	87	174	18	1055	1808	738	1720
TFE12090	Ø12 x 90	90	12	90	120	16	75	15	50	87	174	18	1055	1808	738	1720
TFE12110	Ø12 x 110	110	12	120	170	16	105	5	50	126	251	18	1822	1808	1275	1808
TFE12130	Ø12 x 130	130	12	120	170	16	105	25	50	126	251	18	1822	1808	1275	1808
TFE12150	Ø12 x 150	150	12	120	170	16	105	45	50	126	251	18	1822	1808	1275	1808
TFE14080	Ø14 x 80	80	14	90	120	18	75	5	70	87	174	21	1055	2559	738	1883
TFE14100	Ø14 x 100	100	14	90	120	18	75	25	70	87	174	21	1055	2559	738	1883
TFE14120	Ø14 x 120	120	14	130	185	18	115	5	70	138	276	21	2107	2559	1475	2559
TFE14130	Ø14 x 130	130	14	130	185	18	115	15	70	138	276	21	2107	2559	1475	2559
TFE14140	Ø14 x 140	140	14	130	185	18	115	25	70	138	276	21	2107	2559	1475	2559
TFE14160	Ø14 x 160	160	14	130	185	18	115	45	70	138	276	21	2107	2559	1475	2559
TFE16100	Ø16 x 100	100	-	-	-	-	-	-	-	-	-	-	-	-	-	-
TFE16150	Ø16 x 150	150	-	-	-	-	-	-	-	-	-	-	-	-	-	-
TFE18100	Ø18 x 100	100	18	110	140	22	90	10	90	105	209	24	1384	3680	968	2576
TFE18130	Ø18 x 130	130	18	110	140	22	90	40	90	105	209	24	1384	3680	968	2576

CÓDIGO	MXL	LONGITUD	Ø BROCA	PROFUNDIDAD MÍN. DE TALADRO	MÍN. ESPESOR MATERIAL BASE	Ø ELEMENTO A FIJAR	PROFUNDIDAD MÍN. DEL ANCLAJE	ESPESOR MÁX. A FIJAR	PAR DE APRIETE (NM)	DISTANCIA MÍN. AL BORDE "A"	DISTANCIA MÍN. ENTRE EJES "B"	LLAVE DE INSTALACIÓN	EXTRACCIÓN HORMIGÓN NO-FISURADO	CIZALLADURA HORMIGÓN NO-FISURADO	EXTRACCIÓN HORMIGÓN FISURADO	CIZALLADURA HORMIGÓN FISURADO
TFE18160	Ø18 x 160	160	18	160	225	22	140	20	90	168	336	24	2830	3921	1981	3921
TFE18180	Ø18 x 180	180	18	160	225	22	140	40	90	168	336	24	2830	3921	1981	3921
TFE18200	Ø18 x 200	200	18	160	225	22	140	60	90	168	336	24	2830	3921	1981	3921

TFN Homologado ETE Opt.1. Cabeza hexagonal con recubrimiento cincado y sin arandela

CÓDIGO	MXL	LONGITUD	Ø BROCA	PROFUNDIDAD MÍN. DE TALADRO	MÍN. ESPESOR MATERIAL BASE	Ø ELEMENTO A FIJAR	PROFUNDIDAD MÍN. DEL ANCLAJE	ESPESOR MÁX. A FIJAR	PAR DE APRIETE (NM)	DISTANCIA MÍN. AL BORDE "A"	DISTANCIA MÍN. ENTRE EJES "B"	LLAVE DE INSTALACIÓN	EXTRACCIÓN HORMIGÓN NO-FISURADO	CIZALLADURA HORMIGÓN NO-FISURADO	EXTRACCIÓN HORMIGÓN FISURADO	CIZALLADURA HORMIGÓN FISURADO
TFN14080	Ø14 x 80	80	14	90	120	18	75	5	70	87	174	24	1055	2559	738	1883

TFS Homologado ETE Opt.1. Espárrago cincado

CÓDIGO	MXL	LONGITUD	Ø BROCA	PROFUNDIDAD MÍN. DE TALADRO	MÍN. ESPESOR MATERIAL BASE	Ø ELEMENTO A FIJAR	PROFUNDIDAD MÍN. DEL ANCLAJE	ESPESOR MÁX. A FIJAR	PAR DE APRIETE (NM)	DISTANCIA MÍN. AL BORDE "A"	DISTANCIA MÍN. ENTRE EJES "B"	LLAVE DE INSTALACIÓN	EXTRACCIÓN HORMIGÓN NO-FISURADO	CIZALLADURA HORMIGÓN NO-FISURADO	EXTRACCIÓN HORMIGÓN FISURADO	CIZALLADURA HORMIGÓN FISURADO
TFS06100	Ø6 x 100	100	6	65	100	9	55	35	10	65	129	5	673	608	471	542
TFS06120	Ø6 x 120	120	6	65	100	9	55	55	10	65	129	5	673	608	471	542
TFS08110	Ø8 x 110	110	8	75	100	12	65	32	20	76	152	7	857	950	600	762
TFS08130	Ø8 x 130	130	8	75	100	12	65	52	20	76	152	7	857	950	600	762
TFS10120	Ø10 x 120	120	10	85	120	14	75	27	30	88	176	8	1068	1330	748	987
TFS10140	Ø10 x 140	140	10	85	120	14	75	47	30	88	176	8	1068	1330	748	987

TFF Homologado ETE Opt.1. Rosca hembra métrica cincada

CÓDIGO	MXL	LONGITUD	Ø BROCA	PROFUNDIDAD MÍN. DE TALADRO	MÍN. ESPESOR MATERIAL BASE	Ø ELEMENTO A FIJAR	PROFUNDIDAD MÍN. DEL ANCLAJE	PAR DE APRIETE (NM)	DISTANCIA MÍN. AL BORDE "A"	DISTANCIA MÍN. ENTRE EJES "B"	LLAVE DE INSTALACIÓN	EXTRACCIÓN HORMIGÓN NO-FISURADO	CIZALLADURA HORMIGÓN NO-FISURADO	EXTRACCIÓN HORMIGÓN FISURADO	CIZALLADURA HORMIGÓN FISURADO
TFF06035	Ø6 x 35	35	6	45	100	--	35	10	39	78	13	202	608	185	454
TFF06055	Ø6 x 55	55	6	55	100	--	55	10	65	129	13	673	608	471	542

TFM Homologado ETE Opt.1. Rosca macho métrica cincado

CÓDIGO	MXL	LONGITUD	Ø BROCA	PROFUNDIDAD MÍN. DE TALADRO	MÍN. ESPESOR MATERIAL BASE	Ø ELEMENTO A FIJAR	PROFUNDIDAD MÍN. DEL ANCLAJE	PAR DE APRIETE (NM)	DISTANCIA MÍN. AL BORDE "A"	DISTANCIA MÍN. ENTRE EJES "B"	LLAVE DE INSTALACIÓN	EXTRACCIÓN HORMIGÓN NO-FISURADO	CIZALLADURA HORMIGÓN NO-FISURADO	EXTRACCIÓN HORMIGÓN FISURADO	CIZALLADURA HORMIGÓN FISURADO
TFM06035	Ø6 x 35	35	6	45	100	--	35	10	39	78	13	202	608	185	454
TFM06055	Ø6 x 55	55	6	55	100	--	55	10	65	129	13	673	608	471	542

CH Anclaje antigiro para cargas medias

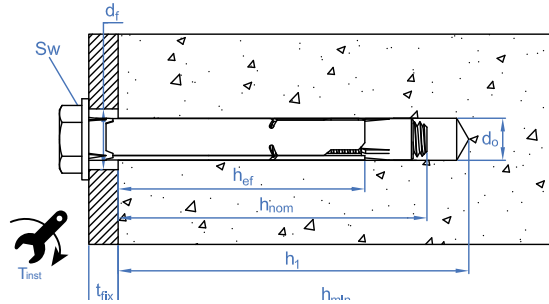

CH-TO Tornillo hexagonal 6.8. Homologado ETE Opt.7

CÓDIGO	MXL	ESPESOR MÁX. A FIJAR	Ø BROCA	PROFUNDIDAD MÍN. DE TALADRO	PROFUNDIDAD MÍN. DEL ANCLAJE	LLAVE DE INSTALACIÓN	PAR DE APRIETE (NM)	Ø ELEMENTO A FIJAR	MÍN. ESPESOR MATERIAL BASE	DISTANCIA MÍN. AL BORDE "A"	DISTANCIA MÍN. ENTRE EJES "B"	EXTRACCIÓN HORMIGÓN NO-FISURADO	CIZALLADURA HORMIGÓN NO-FISURADO
ACHT08C	M6 x 45	5	8	45	39	10	10	9	100	41	41	267	351
ACHT08L	M6 x 60	20	8	45	39	10	10	9	100	41	41	267	351
ACHT09C	M6 x 45	5	9	45	39	10	10	10	100	41	41	267	351
ACHT09L	M6 x 60	20	9	45	39	10	10	10	100	41	41	267	351
ACHT10C	M8 x 60	5	10	60	51	13	20	12	100	54	54	485	604
ACHT10L	M8 x 80	27	10	60	51	13	20	12	100	54	54	485	604
ACHT11C	M8 x 60	5	11	60	51	13	20	13	100	54	54	485	604
ACHT11L	M8 x 80	27	11	60	51	13	20	13	100	54	54	485	604
ACHT12C	M10 x 70	5	12	75	65	17	35	14	100	65	65	662	794
ACHT12L	M10 x 100	32	12	75	65	17	35	14	100	65	65	662	794
ACHT14C	M10 x 70	5	14	75	65	17	35	16	100	65	65	662	794
ACHT14L	M10 x 100	32	14	75	65	17	35	16	100	65	65	662	794
ACHT16C	M12 x 80	5	16	80	70	19	50	18	110	74	74	812	974
ACHT16L	M12 x 110	37	16	80	70	19	50	18	110	74	74	812	974
ACHT20C	M16 x 110	15	20	105	92	24	140	22	145	97	97	1459	2744
ACHT25C	M20 x 130	25	25	130	102	30	240	27	160	120	240	1424	3417

CH-A2 Inoxidable A2. Homologado ETE Opt.7

CÓDIGO	MXL	ESPESOR MÁX. A FIJAR	Ø BROCA	PROFUNDIDAD MÍN. DE TALADRO	PROFUNDIDAD MÍN. DEL ANCLAJE	LLAVE DE INSTALACIÓN	PAR DE APRIETE (NM)	Ø ELEMENTO A FIJAR	MÍN. ESPESOR MATERIAL BASE	DISTANCIA MÍN. AL BORDE "A"	DISTANCIA MÍN. ENTRE EJES "B"	EXTRACCIÓN HORMIGÓN NO-FISURADO	CIZALLADURA HORMIGÓN NO-FISURADO
ACHTA208C	M6 x 45	5	8	45	39	10	10	9	100	41	41	392	329
ACHTA208L	M6 x 60	20	8	45	39	10	10	9	100	41	41	392	329
ACHTA209C	M6 x 45	5	9	45	39	10	10	10	100	41	41	392	329
ACHTA209L	M6 x 60	20	9	45	39	10	10	10	100	41	41	392	329
ACHTA210C	M8 x 60	5	10	60	51	13	20	12	100	54	54	384	600
ACHTA210L	M8 x 80	27	10	60	51	13	20	12	100	54	54	384	600

CÓDIGO	MXL	ESPEJOR MÁX. A FIJAR	Ø BROCA	PROFUNDIDAD MÍN. DE TALADRO	PROFUNDIDAD MÍN. DEL ANCLAJE	LLAVE DE INSTALACIÓN	PAR DE APRIETE (NM)	Ø ELEMENTO A FIJAR	MÍN. ESPESOR MATERIAL BASE	DISTANCIA MÍN. AL BORDE "A"	DISTANCIA MÍN. ENTRE EJES "B"	EXTRACCIÓN HORMIGÓN NO-FISURADO	CIZALLADURA HORMIGÓN NO-FISURADO
ACHTA211C	M8 x 60	5	11	60	51	13	20	13	100	54	54	384	600
ACHTA211L	M8 x 80	27	11	60	51	13	20	13	100	54	54	384	600
ACHTA212C	M10 x 70	5	12	75	65	17	35	14	100	65	65	566	794
ACHTA212L	M10 x 100	32	12	75	65	17	35	14	100	65	65	566	794
ACHTA214C	M10 x 70	5	14	75	65	17	35	16	100	65	65	566	794
ACHTA214L	M10 x 100	32	14	75	65	17	35	16	100	65	65	566	794
ACHTA216C	M12 x 80	5	16	80	70	19	50	18	110	74	74	647	974
ACHTA216L	M12 x 110	37	16	80	70	19	50	18	110	74	74	647	974
ACHTA220C	M16 x 110	15	20	105	92	24	140	22	145	97	97	971	2572

CH-GA

Gancho

CÓDIGO	MXL	ABERTURA GANCHO	Ø BROCA	PROFUNDIDAD MÍN. DE TALADRO	PROFUNDIDAD MÍN. DEL ANCLAJE	LLAVE DE INSTALACIÓN	PAR DE APRIETE (NM)	Ø ELEMENTO A FIJAR	MÍN. ESPESOR MATERIAL BASE	DISTANCIA MÍN. AL BORDE "A"	DISTANCIA MÍN. ENTRE EJES "B"	EXTRACCIÓN HORMIGÓN NO-FISURADO	CIZALLADURA HORMIGÓN NO-FISURADO
ACHG08C	M6 x 45	10	8	45	39	10	10	9	100	41	41	73	-
ACHG09C	M6 x 45	10	9	45	39	10	10	10	100	41	41	73	-
ACHG10C	M8 x 60	13	10	60	51	13	20	12	100	54	54	146	-
ACHG11C	M8 x 60	13	11	60	51	13	20	13	100	54	54	146	-
ACHG12C	M10 x 70	14	12	75	65	17	35	14	100	65	65	243	-
ACHG14C	M10 x 70	14	14	75	65	17	35	16	100	65	65	243	-
ACHG16C	M12 x 80	22	16	80	70	19	50	18	110	74	74	291	-

CH-AR

Argolla

CÓDIGO	MXL	Ø OJO	Ø BROCA	PROFUNDIDAD MÍN. DE TALADRO	PROFUNDIDAD MÍN. DEL ANCLAJE	LLAVE DE INSTALACIÓN	PAR DE APRIETE (NM)	Ø ELEMENTO A FIJAR	MÍN. ESPESOR MATERIAL BASE	DISTANCIA MÍN. AL BORDE "A"	DISTANCIA MÍN. ENTRE EJES "B"	EXTRACCIÓN HORMIGÓN NO-FISURADO	CIZALLADURA HORMIGÓN NO-FISURADO
ACHA08C	M6 x 45	10	8	45	39	10	10	9	100	41	41	73	-
ACHA09C	M6 x 45	10	9	45	39	10	10	10	100	41	41	73	-
ACHA10C	M8 x 60	13	10	60	51	13	20	12	100	54	54	146	-
ACHA11C	M8 x 60	13	11	60	51	13	20	13	100	54	54	146	-
ACHA12C	M10 x 70	14	12	75	65	17	35	14	100	65	65	243	-
ACHA14C	M10 x 70	14	14	75	65	17	35	16	100	65	65	243	-
ACHA16C	M12 x 80	22	16	80	70	19	50	18	110	74	74	291	-

CH-PL

Cabeza plana. Homologado ETE Opt.7. Homologado ETE Opción 7.

CÓDIGO	MXL	ESPEJOR MÁX. A FIJAR	Ø BROCA	PROFUNDIDAD MÍN. DE TALADRO	PROFUNDIDAD MÍN. DEL ANCLAJE	LLAVE DE INSTALACIÓN	PAR DE APRIETE (NM)	Ø ELEMENTO A FIJAR	MÍN. ESPESOR MATERIAL BASE	DISTANCIA MÍN. AL BORDE "A"	DISTANCIA MÍN. ENTRE EJES "B"	EXTRACCIÓN HORMIGÓN NO-FISURADO	CIZALLADURA HORMIGÓN NO-FISURADO
ACHTPL08C	M6 x 45	5	8	45	39	4	10	9	100	41	41	267	392
ACHTPL08L	M6 x 60	20	8	45	39	4	10	9	100	41	41	267	392
ACHTPL10C	M8 x 60	5	10	60	51	5	20	12	100	54	54	485	604
ACHTPL10L	M8 x 80	27	10	60	51	5	20	12	100	54	54	485	604
ACHTPL12C	M10 x 70	5	12	75	65	6	35	14	100	65	65	662	794
ACHTPL12L	M10 x 100	32	12	75	65	6	35	14	100	65	65	662	794

CH-PI

Cabeza plana inoxidable A2. Homologado ETE Opt.7

CÓDIGO	MXL	ESPEJOR MÁX. A FIJAR	Ø BROCA	PROFUNDIDAD MÍN. DE TALADRO	PROFUNDIDAD MÍN. DEL ANCLAJE	LLAVE DE INSTALACIÓN	PAR DE APRIETE (NM)	Ø ELEMENTO A FIJAR	MÍN. ESPESOR MATERIAL BASE	DISTANCIA MÍN. AL BORDE "A"	DISTANCIA MÍN. ENTRE EJES "B"	EXTRACCIÓN HORMIGÓN NO-FISURADO	CIZALLADURA HORMIGÓN NO-FISURADO
ACHTPI08C	M6 x 45	5	8	45	39	4	10	9	100	41	41	392	329
ACHTPI08L	M6 x 60	20	8	45	39	4	10	9	100	41	41	392	329
ACHTPI10C	M8 x 60	5	10	60	51	5	20	12	100	54	54	384	600
ACHTPI10L	M8 x 80	27	10	60	51	5	20	12	100	54	54	384	600
ACHTPI12C	M10 x 70	5	12	75	65	6	35	14	100	65	65	566	794
ACHTPI12L	M10 x 100	32	12	75	65	6	35	14	100	65	65	566	794

CH-INB

Cabeza inviolable cincada. Homologado ETE Opt.7

CÓDIGO	MXL	ESPEJOR MÁX. A FIJAR	Ø BROCA	PROFUNDIDAD MÍN. DE TALADRO	PROFUNDIDAD MÍN. DEL ANCLAJE	LLAVE DE INSTALACIÓN	PAR DE APRIETE (NM)	Ø ELEMENTO A FIJAR	MÍN. ESPESOR MATERIAL BASE	DISTANCIA MÍN. AL BORDE "A"	DISTANCIA MÍN. ENTRE EJES "B"	EXTRACCIÓN HORMIGÓN NO-FISURADO	CIZALLADURA HORMIGÓN NO-FISURADO
ACHINB08C	M6 x 45	5	8	45	39	TX40	10	9	100	41	41	267	219
ACHINB08L	M6 x 60	20	8	45	39	TX40	10	9	100	41	41	267	219
ACHINB10C	M8 x 60	5	10	60	51	TX40	20	12	100	54	54	485	399
ACHINB10L	M8 x 80	27	10	60	51	TX40	20	12	100	54	54	485	399

CH-INN

Cabeza inviolable cincada negra. Homologado ETE Opt.7

CÓDIGO	MXL	ESPEJOR MÁX. A FIJAR	Ø BROCA	PROFUNDIDAD MÍN. DE TALADRO	PROFUNDIDAD MÍN. DEL ANCLAJE	LLAVE DE INSTALACIÓN	PAR DE APRIETE (NM)	Ø ELEMENTO A FIJAR	MÍN. ESPESOR MATERIAL BASE	DISTANCIA MÍN. AL BORDE "A"	DISTANCIA MÍN. ENTRE EJES "B"	EXTRACCIÓN HORMIGÓN NO-FISURADO	CIZALLADURA HORMIGÓN NO-FISURADO
ACHINN08C	M6 x 45	5	8	45	39	TX40	10	9	100	41	41	267	219
ACHINN08L	M6 x 60	20	8	45	39	TX40	10	9	100	41	41	267	219
ACHINN10C	M8 x 60	5	10	60	51	TX40	20	12	100	54	54	485	399
ACHINN10L	M8 x 80	27	10	60	51	TX40	20	12	100	54	54	485	399

Parámetros punta-broca

			Ø 3.5	Ø 3.9	Ø 4.2	Ø 4.8	Ø 5.5	Ø 6.3
Fuerza máxima instalación		N	150	200	250	250	350	350
Velocidad taladrado	Acero	rpm	1.800 - 2500				1000 - 1800	
	Acero inox	rpm	1.000 - 1500				600 - 1000	
Par máximo		Nm	2.8	3.8	4.7	6.9	10.4	16.9

Taladro previo rosca-chapa

Medida	Espesor de chapa	Ø Broca núcleo		Medida	Espesor de chapa	Ø Broca núcleo	
		Aluminio	Acero-latón			Aluminio	Acero-latón
2,9 Nº4	0,4 - 0,6	2,20	2,25	4,8 Nº10	0,4 - 0,6	-	-
	0,6 - 1,0	2,20	2,40		0,6 - 1,0	3,70	3,80
	1,0 - 1,5	2,25	2,40		1,0 - 1,5	3,70	3,80
	1,5 - 2,5	2,40	2,50		1,5 - 2,5	3,80	3,90
	2,5 - 4,0	-	-		2,5 - 4,0	3,80	4,00
3,5 Nº6	0,4 - 0,6	2,70	2,70	5,5 Nº12	0,4 - 0,6	-	-
	0,6 - 1,0	2,70	2,80		0,6 - 1,0	4,30	4,40
	1,0 - 1,5	2,80	2,80		1,0 - 1,5	4,30	4,40
	1,5 - 2,5	2,80	2,90		1,5 - 2,5	4,40	4,50
	2,5 - 4,0	-	3,00		2,5 - 4,0	4,40	4,60
3,9 Nº7	0,4 - 0,6	-	-	6,3 Nº14	0,4 - 0,6	-	-
	0,6 - 1,0	3,00	3,10		0,6 - 1,0	5,00	5,10
	1,0 - 1,5	3,00	3,10		1,0 - 1,5	5,00	5,10
	1,5 - 2,5	3,10	3,20		1,5 - 2,5	5,10	5,20
	2,5 - 4,0	3,10	3,30		2,5 - 4,0	5,10	5,30
4,2 Nº8	0,4 - 0,6	-	-				
	0,6 - 1,0	3,20	3,30				
	1,0 - 1,5	3,20	3,30				
	1,5 - 2,5	3,30	3,40				
	2,5 - 4,0	3,30	3,50				

Tabla de selección de tornillos punta broca

TORNILLO	Ø ROSCA	ESPESOR A TALADRAR EN ACERO [mm]																		
AUTO	5,5	4,0																	12,0	
ABE ABR ABP RS	6,3	2,5													6,0					
	5,5	1,75										5,25								
	4,8	1,75										4,4								
	4,2	1,75										3,0								
	3,9	0,7		2,4																
	3,5	0,7		2,25																
ABA / ATA	6,3	2,5													6,0					
	5,5	1,75										5,0								
	4,8	1,75										4,0								
TAE	4,2	0,75		2,5																
BCP	4,2	0,7		2,0																
ARE	6,3	1,0		1,5																
	5,5	1,0		1,5																
	4,8	0,3		1,0																
PS	5,5	1,5										6,0								
PSL	5,5	6,0																	12,0	

0,00 0,25 0,50 0,75 1,00 1,25 1,50 1,75 2,00 2,25 2,50 2,75 3,00 3,25 3,50 3,75 4,00 4,25 4,50 4,75 5,00 5,25 5,50 5,75 6,00 6,5 7,0 7,5 8,0 8,5 9,0 9,5 10,0 10,5 11,0 11,5 12,0

TORNILLO	Ø ROSCA	ESPESOR A TALADRAR EN ALUMINIO [mm]																		
BIE	4,8	1,75										4,4								
	5,5	1,75										5,25								
	6,3	2,5										6,0								
BAUTO	5,5	4,0																	12,0	

0,00 0,25 0,50 0,75 1,00 1,25 1,50 1,75 2,00 2,25 2,50 2,75 3,00 3,25 3,50 3,75 4,00 4,25 4,50 4,75 5,00 5,25 5,50 5,75 6,00 6,5 7,0 7,5 8,0 8,5 9,0 9,5 10,0 10,5 11,0 11,5 12,0

Espeor máximo a fijar

LONGITUD	ST 3,5	ST 3,9	ST 4,2	ST 4,8	ST 5,5	ST 6,3
9,5	2,85					
11	4,2					
13	6,2	5,8	4,3	3,7		
16	9,2	8,8	7,3	5,5		
19	12,1	11,7	10,3	8,7	8,7	7
22	15,1	14,7	13,3	11,7	11,7	10
25	18,1	17,7	16,3	14,7	14,7	13
32	25,1	24,5	23	21,5	21,5	20
38		30,5	29	27,5	27,5	26
45			36	34,5	34,5	33
50			41	39,5	39,5	38
60				49,5	49,5	48
63				52,5	52,5	51
73				62,5	62,5	61
75				64,5	64,5	63
80				69,5		68
90				79,5		78
100				89,5		88
110						98
120						108
130						118
140						128

* No válido para tornillo AUTO

RED COMERCIAL ESPAÑA

ÁLAVA

Mikel Paredes
mparedes@indexfix.com
Tfno. 679 559 519

ALBACETE

Antonio Álvarez
a.alvarezmegias@gmail.com
Tfno. 678 537 861

ALICANTE

Valentín Ramos
representacionesvalentin@gmail.com
Tfno. 606 305 980
Maxi Flores
Tfno. 647 447 793

ALMERÍA

José María Pérez Capel
representaciones@perezcapel.com
Tfno. 683 353 495

ANDORRA

Pere Soro
peresoro@gmail.com
Tfno. 609 363 693

ASTURIAS

Asier Saenz
asaenz@indexfix.com
Tfno. 941 272 131

ÁVILA

Vicente Beltrán
vicentebeltran@telefonica.net
Tfno. 609 616 926

BADAJOS

Adrián Apellaniz
aapellaniz@indexfix.com
Tfno. 941 272 131

BALEARES

Antonio Forteza
repforpa@gmail.com
Tfno. 636 973 665
Agustín Forteza
repreforteza@gmail.com
Tfno. 660 725 880

BARCELONA - TARRAGONA

Roger Rosell
rrosell@indexfix.com
Tfno. 618 361 743

BURGOS

Óscar Aliende
oaliende@indexfix.com
Tfno. 629 777 206

CÁCERES

Adrián Apellaniz
aapellaniz@indexfix.com
Tfno. 941 272 131

CÁDIZ

José Antonio Prieto
prietocadiz@yahoo.es
Tfno. 667 552 000

CANARIAS

Alfredo Carrancio Sosa
accarrancio@indexfix.com
Tfno. 600 462 930

CANTABRIA

Mikel Paredes
mparedes@indexfix.com
Tfno. 679 559 519

CASTELLÓN

Francisco Blasco
representacionesblasco@gmail.com
Tfno. 639 672 267

CEUTA

Luís Fernando Reguera
luis@representacionesreguera.com
Tfno. 696 416 886

CIUDAD REAL

Vicente Beltrán
vicentebeltran@telefonica.net
Tfno. 609 616 926

CÓRDOBA

Adrián Apellaniz
aapellaniz@indexfix.com
Tfno. 941 272 131

CUENCA

Vicente Beltrán
vicentebeltran@telefonica.net
Tfno. 609 616 926

GERONA

David Mejías
lunadarepres@gmail.com
Tfno. 622 453 509

GRANADA

Ismael Marco
ismaelmarcorios@gmail.com
Tfno. 670 242 337
Armando Ríos
Tfno. 670 453 269

GUADALAJARA

Vicente Beltrán
vicentebeltran@telefonica.net
Tfno. 609 616 926

GUIPÚZCOA

Koldo Balda González
baldas@yahoo.es
Tfno. 629 476 660

HUELVA

Jose M^o Castillo
jmcastilloq@yahoo.es
Tfno. 667 769 427

HUESCA

Fernando Gonzalo
fgonzalo@fgms.es
Tfno. 609 879 313

JAEN

Ismael Marco
ismaelmarcorios@gmail.com
Tfno. 670 242 337
Armando Ríos
Tfno. 670 453 269

LA CORUÑA

Carlos Seoane
cseoane@indexfix.com
Tfno. 618 614 872

LA RIOJA

Álvaro Bartolomé
abartolome@indexfix.com
Tfno. 608 278 355

LEÓN

Francisco Viñuela
pacovinelaleon@hotmail.com
Tfno. 670 597 272

LLEIDA

Pere Soro
peresoro@gmail.com
Tfno. 609 363 693

LUGO

Carlos Seoane
cseoane@indexfix.com
Tfno. 618 614 872

MADRID

Sergio de Miguel
sdemiguel@indexfix.com
Tfno. 608 566 769
Álvar Martín
amartin@indexfix.com
Tfno. 630 175 362
Cristina Conde
cconde@indexfix.com
Tfno. 638 547 099
Francisco Hernandez
fhernandez@indexfix.com
Tfno. 747 449 280

MÁLAGA

Antonio J. Martín
repmartin@hotmail.com
Tfno. 610 701 604
Enrique Martín
Tfno. 667 574 316

MELILLA

Enrique Martín
repmartin@hotmail.com
Tfno. 667 574 316

MURCIA

Facundo Cuenca e Hijos, S.L.
info@facundocuenca.com
Tfno. 968 898 167

NAVARRA

Eduardo Pellejero
epellejerobalda@telefonica.net
Tfno. 658 842 592

ORENSE

Carlos Seoane
cseoane@indexfix.com
Tfno. 618 614 872

PALENCIA

Óscar Aliende
oaliende@indexfix.com
Tfno. 629 777 206

PONTEVEDRA

Carlos Seoane
cseoane@indexfix.com
Tfno. 618 614 872

SALAMANCA

Javier Vecino
javiervicino@hotmail.com
Tfno. 609 811 878

SEGOVIA

Vicente Beltrán
vicentebeltran@telefonica.net
Tfno. 609 616 926

SEVILLA

José Antonio Bonilla
jabonilla@jabonilla.es
Tfno. 607 433 102

SORIA

Comercial Arrieta C.B.
gorka_arrieta@yahoo.es
Tfno. 619 416 914

TERUEL

Fernando Gonzalo
fgonzalo@fgms.es
Tfno. 609 879 313

TOLEDO

Vicente Beltrán
vicentebeltran@telefonica.net
Tfno. 609 616 926

VALENCIA

Francisco Blasco
representacionesblasco@gmail.com
Tfno. 639 672 267

VALLADOLID

Javier Vecino
javiervicino@hotmail.com
Tfno. 609 811 878

VIZCAYA

Mikel Paredes
mparedes@indexfix.com
Tfno. 679 559 519

ZAMORA

Francisco Viñuela
pacovinelaleon@hotmail.com
Tfno. 670 597 272

ZARAGOZA

Fernando Gonzalo
fgonzalo@fgms.es
Tfno. 609 879 313

PRESENCIA INTERNACIONAL



FRANCIA - Aquitania, Languedoc-Rosellón, Lemosín, Mediodía-Pirineos
Thierry Nouvel - T-Nouvel
t-nouvel@indexfix.com
+ 33 (0) 608.578.114

FRANCIA - Auvernia, Borgoña, Ródano-Alpes
Sales-up
Martin Broizart
m.broizat@directfab.fr
+ 33 (0) 665.493.382

FRANCIA - Bretaña, Países del Loira
Rodolphe Hirn
rhirn@indexfix.com
+ 33 (0) 676.282.469

FRANCIA - Isla de Francia
Geoffroy Ehlinger
gehlinger@indexfix.com
+ 33 (0) 675.474.552

FRANCIA - Córcega
Franck Platerier
franck.platerier@sdpro.fr
+ 33 (0) 7 85 42 10 28

FRANCIA - DOM TOM
Jacques Vergé
jverge@indexfix.com
+ 33 (0) 468.691.968

FRANCIA - PACA
Jean Vivien
contact.sdpro@free.fr
+33 (0) 607.853.297

FRANCIA - ESTE
Frederic Koenig
fred.koenig@outlook.fr
+ 33 (0) 633454230

FRANCIA - NORTE Y NORMANDÍA
Eric Ducrocq
educrocq@ixsaw.com
+ 33 (0) 6 85 52 13 05

ALEMANIA
Dieter Fernandez
dfernandez@indexfix.com
+ 49 (0) 171 27 64 898

ITALIA (Campania)
Sansone Rappresentanza
sansonerappresentanza@gmail.com
+39 3925804863

RUMANÍA
Dacian Lupu
dlupu@indexfix.com
+ 40 775 197 970

SENEGAL / COSTA DE MARFIL
BENIN / CAMERÚN / GABÓN / CONGO
Jacques Vergé
jverge@indexfix.com
+ 33 (0) 468.691.968

MARRUECOS
NOUMAREP
Brahim Nouçair
noucair@indexfix.com
+ 212 (0) 122.230.21.27

PORTUGAL
Marco Sousa
marcosousa@indexfix.com
+ 351 913.908.536

GRECIA
M.I. SASSON & CO O.E.
msaso@indexfix.com
+ 30 6932 406 106

ALEMANIA
ARABIA SAUDITA
ARGELIA
AUSTRALIA
AUSTRIA
BANGLADESH
BÉLGICA
BENÍN
BOLIVIA
BOSNIA
BULGARIA
CAMERÚN
CHIPRE
COLOMBIA
CONGO
COSTA DE MARFIL
CROACIA
CUBA
DINAMARCA
EGIPTO
EMIRATOS ÁRABES
ESCOCIA
ESLOVENIA
ESTADOS UNIDOS
ESTONIA
FINLANDIA
FRANCIA
GABÓN
GRECIA
GUAYANA FRANCESA
GUINEA ECUATORIAL
HOLANDA
HONDURAS
HUNGRÍA
INDIA
INDONESIA
INGLATERRA
IRÁN
IRLANDA
IRLANDA DEL NORTE
ISLA GUADALUPE
ISLANDIA
ISRAEL
ITALIA
KOSOVO
KUWAIT
LETONIA
LÍBANO
LITUANIA
LUXEMBURGO
MACEDONIA
MADAGASCAR
MALTA
MARRUECOS
MARTINICA
MAURICIO
MÉXICO
MONTENEGRO
NORUEGA
NUEVA CALEDONIA
OMÁN
PAKISTÁN
PANAMÁ
PERÚ
POLINESIA FRANCESA
POLONIA
PORTUGAL
QATAR
REPUBLICA CHECA
REPUBLICA DOMINICANA
REPUBLICA ESLOVACA
REUNIÓN
RUMANIA
RUSIA
SENEGAL
SERBIA
SINGAPUR
SUECIA
SUIZA
TAILANDIA
TÚNEZ
TURQUÍA
UCRANIA
URUGUAY



INDEX[®]
A PERFECT FIXING

The image shows a close-up of a brown cardboard box in the foreground. The box features the 'INDEX' logo in a bold, blue, sans-serif font, with a registered trademark symbol (®) to its upper right. Below the logo, the slogan 'A PERFECT FIXING' is printed in a smaller, blue, sans-serif font. The background is a blurred warehouse or industrial environment with overhead fluorescent lights and a person in a dark blue uniform working in the distance.

CONDICIONES DE VENTA ESPAÑA

PORTES

Los portes serán pagados a partir de 250€ netos para los envíos a la península y Baleares. En este caso, nos reservamos el derecho a remitir las mercancías por nuestra habitual agencia de transportes.

En el caso de que los portes sean debidos y salvo indicación expresa por parte del cliente, las mercancías las enviaremos por nuestra habitual agencia de transportes.

Rogamos procedan a verificar el estado de la mercancía a su recepción y formulen ante el transportista las reservas que en su caso procedan, comunicándonos las posibles objeciones de inmediato.

La recepción de la mercancía, supone la aceptación de las condiciones generales de venta de INDEX A Perfect Fixing.

El importe mínimo de pedido es de 100€. Por cuestiones derivadas de costos y, en el caso de aceptarse un pedido de importe inferior, se cargarán 10€ en concepto de gastos de gestión.

CONDICIONES DE PAGO

Forma de pago: Giro bancario domiciliado a 60 días máximo.

Si las letras no están domiciliadas, INDEX A Perfect Fixing, en ningún caso se hará cargo de los posibles gastos de devolución.

Los documentos de pago, deberán ser remitidos en un plazo máximo de 30 días posteriores a la fecha de la factura.

Los documentos de pago que no respeten los vencimientos reflejados en nuestra factura, ocasionarán un cargo por aplazamiento del 1% mensual.

Nuestro sistema informático retendrá automáticamente los pedidos si se produjese algún impago o demora en la recepción de documentos de pago.

PLAZO DE ENTREGA

Salvo acuerdo expreso por nuestra Central, los plazos de entrega indicados por nuestros representantes son a título orientativo.

El retraso de los plazos de entrega o fechas previstas no dará lugar a penalización.

AGOSTO Y DICIEMBRE

Los vencimientos que se atiendan en estos meses, no tendrán cargos ni abonos. Si el vencimiento se fracciona al 50% entre el mes anterior y posterior, no se aplicarán cargos ni abonos.

Si el vencimiento se adelanta al mes anterior, se abonará en factura un 1% de descuento en concepto de pago adelantado.

Si el vencimiento se aplaza al mes siguiente, se cargará en factura un 1% en concepto de gastos financiero.

DEVOLUCIÓN DE MATERIAL

No se admitirán devoluciones de material transcurridos 15 días desde la fecha de entrega.

Si la devolución se produce por motivos no imputables a INDEX A Perfect Fixing el cliente la enviará a portes pagados. Adicionalmente se le cargará el coste que se origine en concepto de reempaquetado, así como los del transporte del envío inicial. En total el recargo supondrá un 20% aproximado del valor de la mercancía.

El importe de la mercancía devuelta o abono, será descontado de la factura de origen y se le notificará al cliente.

No se admitirán devoluciones de material a portes debidos, si no vienen por nuestras agencias habituales de transporte.

Para cualquier cuestión derivada de la venta efectuada por INDEX A Perfect Fixing (Técnicas Expansivas, S.L.), serán competentes los Juzgados y Tribunales de la ciudad de Logroño. Los precios de esta tarifa, no incluyen el IVA. INDEX A Perfect Fixing se reserva el derecho a cambiar precios, envasados o artículos en stock sin previo aviso.

INDEX A Perfect Fixing, a razón de sus necesidades de producción, se reserva el derecho a modificar sin previo aviso el diseño, las características o prestaciones de sus productos. Las imágenes de este catálogo, son ilustraciones informativas sin ningún valor contractual, pudiendo no coincidir con el modelo original.

GAMA COMPLETA INDEX A PERFECT FIXING























































































Fijaciones metálicas

	MTP		43				SL-PT		59			
	MTP-A4		43				SL-PC		59			
NEW	MTP-AT		44				CH-TO		61			
	MTP-X		44				CH-A2		61			
	MTP-G		45				CH-8.8		62			
	MTH		46				CH-8.8 E		62			
NEW	MTH-AT		47				CH-PL		62			
	MTH-A2		48				CH-PI		62			
	MTH-A4		48				CH-INB		63			
	MTA		49				CH-INN		63			
	DO-MT		51				CH-ES		63			
	TWA		51				CH-GA		64			
NEW	TP-MT BL		51				CH-GE		64			
NEW	TP-MT NE		51				CH-GF		64			
	THE		53				CH-GF A2		64			
	THA		53				CH-AR		65			
	THP		54				CH-AF		65			
	THT		54				CH-AF A2		65			
NEW	TXE		54				HE-HO		67			
	TFE		55				HE-A4		67			
	TFN		55				HE-CL		67			
	TFS		56				HE-C4		67			
	TFF		56				HE-HC		68			
	TFM		56				HE-NO		68			
	HP		57			NEW	HE-NS		68			
	HPZ		57			NEW	HE-HO SDS		68			
	HP TP		57				HE-HC SDS		68			
	HR		57				EXP		69			
	HEA		58				EXP-C		69			
	HEA + ARVUL		58				HC		69			
							TA-ME		70			









GAMA COMPLETA INDEX A PERFECT FIXING

AN-CU		70			AN-TA	76				
TC-MA		70			Fijaciones químicas					
AC-CA		71			MO-PU		79			
AC-CI		71			MO-P+		79			
AC-TO		71			MO-PS+		79			
AC-ES		71			MO-PSP+		79			
AC-GA		71			MO-V		80			
AC-AR		71			MO-VS		80			
ZA-CA		72			MO-H		80			
ZA-TO		72			MO-HW		80			
ZA-TL		72			MOPURE		81			
ZA-PR		72			MOPUR3		81			
ZA-ES		72			MOPISTO		82			
ZA-GA		73			MOPISPR		82			
ZA-GF		73			MOPISSI		82			
ZA-AR		73			MOPISPUR6		82			
ZA-AF		73			MOPISNEU		82			
HI-CA		74			MOPISP3		82			
HI-CI		74			MOBOMBA		82			
HI-TO		74			MORCANU		82			
HI-GA		74			MORCAPU		82			
HI-AR		74			MORCEPKIT		82			
EPS		75			NEW MO-TL		82			
TRA		75			NEW MO-PC		82			
AVR		75			MO-TN		82			
AVC		75			MO-ES		82			
AN-23		76			MO-TR		82			
AN-51		76			MO-TM		82			
AN-50 CT		76			CA-QU		83			
TC-SO 2		76			EQ-AC		83			
TC-SO 8		76								





GAMA COMPLETA INDEX A PERFECT FIXING

EQ-8.8	83			T-NUX	96	
EQ-A2	83			TC-6A	97	
EQ-A4	83			TC-6E	97	
MS-PR	85			TC-2A	97	
MS-TR	85			TC-SP	98	
MS-SF	85			TC-SP EP	98	
SI-PR	87			TC-A2	98	
SI-PRS	87			TC-CC	98	
SI-UNI	87			TC-CA	99	
SI-UNS	88			TC-CA EP	99	
SE-ACR	88			TN4S	100	
PU-SP	89			TN4S EP	100	
PU-SC	89			TN4S + AL-HA	101	
PU-TP	89			TN4S + AL-HC	101	
PU-TPR	90			TN4S + AL-RO	101	
PU-TC	90		 	TN4S + AL-RO	101	
PU-FP	90			TN4S + DIN-571	101	
PU-FC	91			TN4S + TP-PO	101	
PU-EP	91		 	TN4S + TP-PO EP	102	
PU-CL	91			TN4S-L	102	
PU-PI	92			TN4S-A	102	
PU-PI 2	92			TN4S-A EP	102	
PU-CA	92			MEDU	102	
Fijaciones plásticas						
T-NUX A		95	 	TACON + AL-HA	103	
T-NUX A A4		95	 	TACON + AL-HC	103	
T-NUX E		95	 	TACON + AL-RO	103	
T-NUX E A4		96	 	TACON + TP-PO	103	
T-NUX T		96	 	TACON	104	
T-FUX E		96	 			









GAMA COMPLETA INDEX A PERFECT FIXING

TACOL	104	
TACOL-A	104	
NEW IPA-CA	105	
IPA-GR	105	
IPA-GN	105	
IPA-AR	105	
IPA-TO	105	
TA-PL	105	

Fijaciones y accesorios para sistemas de aislamiento térmico (SATE)













AIS-C		108	
AIS-S		108	
AIS		108	
AIS-R		108	
AIS-W		109	
AIS-M		109	
AIS-AM		109	
TE		109	

Fijaciones para materiales huecos

BA-ES	112	
BA-GA	112	
CA-BA	112	
PA-ES	113	
PA-GA	113	
CA-PA	113	
IN-CO	114	
IN-HE	114	
IN-SI	114	

INPIN	115	
INPIS	115	
KITINPIN	115	
ANCLA	116	
TAPLA NY	116	
TAPLA ME	116	
TAPLA ZK	116	

























Remaches

RE-NO	118	
RE-IN	119	
RE-CA	119	
RE-BL	119	
RE-NE	120	
RE-FL	120	
TR-AV	121	
TR-CA	121	
TR-CR	121	
RM-MA	122	
RM-PA	122	
RM-EX	122	





Accesorios para cable, cadena y cercados

















SJ-Z	124	
NEW SJ-A4	124	
NEW SJ-O	124	
NEW SJ-PS	125	
NEW SJ-PS A4	125	
NEW SJ-PD	125	
NEW SJ-PD A4	125	

GAMA COMPLETA INDEX A PERFECT FIXING











NEW	TS-GA A4	126	
NEW	TS-AA	126	
NEW	TS-GG	127	
NEW	TS-GG A4	127	
NEW	TS-VS	127	
	EV-H	128	
NEW	EV-H A4	128	
	EV-M	128	
NEW	EV-M A4	128	
	GR-Z	129	
NEW	GR-A4	129	
	GD-Z	130	
NEW	GD-A4	130	
NEW	GI-A4	131	
NEW	GS-Z	131	
NEW	MQ-BS	131	
NEW	MQ-B	131	
	CM-BP	132	
	CM-BT	132	
	CM-TA	132	
	CM-TP	132	
	CM-UN	132	
	CM-TENSO	133	
	CM-TENSOVE	133	
	CM-TT	133	

Fijaciones y accesorios para placa de yeso

	PL-F	136	
	PL-EP	136	
	PL-CA	137	
	PL-RA	137	

	PL-TR	137	
	CP-PA	138	
	CP-GV	138	
	CP-AC	138	
	CP-MV	138	
	OME	139	
	MAB	139	
	HO-CU	139	
	HO-CR	139	
	EMP	140	
	CAB	140	
	ADU	140	
	PCU	140	
	SUS	141	
	TR-BL	141	
	TR-13	141	
	TR-15	141	



Fijación directa

















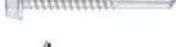





	FP08GUN	144	
	FP12GUN	144	
	FP-IP	144	
	FP-CG 08	145	
	FP-CL 08	145	
	FP-AP 08	145	
	FP-C30	145	
	FP-AM 08	145	
	FP-CR 08 M6	146	
	FP-CR 08 M8	146	
	FP-PI 08	146	

GAMA COMPLETA INDEX A PERFECT FIXING





FP-CG 12	146	
FP-CGD12	146	
FP-CL12	146	
FP-CLD12	147	
FP-CT12	147	
FP-PISCL08	147	
FP-PISPL08	147	
FP-PISCL12	147	
FP-PISCM12	147	
FP-PISCT12	147	
FG-GUN	148	
FG-GUNEL	148	
FG-CL	149	
FG-CLH	149	
OME	149	
FG-ARAM	149	
FG-ARAM EP	149	
FG-PLET	150	
AB-PID	150	
FG-ABRA	150	
FG-CAEL	151	
FG-CLCAR	151	
FG-IMAN	151	
FG-BAT	151	
FG-CAR	151	
FG-GAS	151	

Tornillos para cubiertas y fachadas





























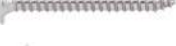

DIN-7504-K	154	
DIN-7504-K A2	154	







DIN-7504-K + ARVUL	155	
DIN-7504-K CP + ARVUL	155	
DIN-7504-K RE	156	
DIN-7504-K RE + ARVUL	156	
NEW DIN-7504-K RE NI + ARVUL	156	
ABE BIMETAL	157	
ABE BIMETAL + ARVUL	157	
AUTO BIMETAL	158	
AUTO BIMETAL + ARVUL	158	
AUE	158	
AUE + ARVUL	159	
NEW AUE NI + ARVUL	159	
PS 3	159	
PS 3 + ARVUL	159	
PS 3 + ARVUL A2	160	
PS 5	160	
PS 5 + ARVUL	160	
PS 5 + ARVUL A2	160	
FIBR	160	
ARVUL	161	
ARVUL A2	161	
NEW ARPAR	161	
NEW ARPAR A2	161	
ATAP	162	

Tornillos broca, rosca chapa y pvc

















DIN-7504-N HP Z	164	
DIN-7504-N HP A2	165	
DIN-7504-N HP N	165	
DIN-7504-N HP B	165	
DIN-7504-N HT	166	

GAMA COMPLETA INDEX A PERFECT FIXING





























































DIN-7504-N HC	166	
DIN-7504-P HP Z	167	
DIN-7504-P HP N	168	
DIN-7504-P HT Z	168	
ABA	169	
ATA	169	
RS	169	
RS-A2	169	
BCP Z	170	
BCP A2	170	
BCP N	170	
BCP B	170	
BCP CB	170	
TAEZ	171	
TAEN	171	
DIN-7981 HP B	171	
DIN-7981 HP N	171	
DIN-7981 HP Z	172	
DIN-7982 HP Z	173	
CP-Z	175	
CP-A2	175	
CP-B	175	
CP-N	175	
PVC-10 Z	176	
PVC-20 B	176	
PVC-20 Z	176	
PVC-30	176	
PVC-40 B	176	
PVC-40 Z	177	
PVC-50 B	177	
PVC-50 Z	177	

PVC-70	177	
PVC-70 TP	177	
PVC-90	178	
PVC-VEK	178	
PVC-VEK 13	178	
PVC-VEK 10	178	
PVC-KOM 10	178	





Tornillos para madera

TEX-BP	180	
TEX-ZP	181	
TEX-ZT	183	
TEX-A2	183	
TEC-BT	185	
TEX-AB	185	
TP-PO B	188	
TP-PO Z	190	
TP-TO	192	
TP-A2	193	
TR-PO	193	
DIN-571	194	
DIN-571 A2	195	
571 TR	195	
INV Z	195	
INV A2	196	
INV N	196	
ESTRINV Z	196	
ESTRINV N	196	
TRE-Z	197	
TRE-PV	197	
FS Z	197	

























GAMA COMPLETA INDEX A PERFECT FIXING



FS 3009	197		SC-EI	214	
FS 3011	198		SC-ED	214	
FS 5010	198		SC-LD	214	
FS 6005	198		SC-GA	215	
FS 8004	198		SC-RF	215	
FS 8017	198		SC-RG	215	
FS 8019	199		SC-AS	215	
FS 9006	199		SC-CE	215	
FS 9010	199		SC-OB	216	
FS 9011	199		SC-OZ	216	
FIMA	199		SC-CD Z	216	
Puntas, alcayatas y hembrillas			SC-CI	216	
AL-RE	202		SC-EM	216	
AL-PL	202		SC-ER	217	
AL-RO	203		SC-GE Z	217	
AL-RO B	203		SC-MX	217	
AL-HC	204		SC-PD	217	
AL-HC B	204		SC-RE Z	217	
AL-HA	205		SC-LC Z	217	
AL-HA B	205		PT-BR	218	
HC-RM	206		PT-EM	218	
HA-RM	206		PT-ET	218	
PA-CP	207		PT-OB	218	
PA-CC	207		PT-TT	218	
PA-CX	208		PT-UN	218	
GM-Z	208		AP-AR	219	
CF-B	208		AP-AT	219	
SV-C	209		AP-FL	219	
Conectores para madera			AP-FU Z	219	
SO-UO	214		AP-PD	219	
SO-UR	214		AP-PG	219	

GAMA COMPLETA INDEX A PERFECT FIXING













AP-PT	220	
AP-UE Z	220	
AP-SB	220	
AP-EN	220	
VM-PF	220	

Tornillería normalizada

DIN-933	222	
DIN-933 A2	224	
DIN-931	225	
DIN-6921	226	
DIN-6921 A2	226	
DIN-912	227	
DIN-603/934	228	
DIN-603 A2	229	
DIN-608	229	
DIN-84	229	
DIN-7985	230	
DIN-963	231	
DIN-965	231	
DIN-934	232	
DIN-934 A2	232	
DIN-985	233	
DIN-985 A2	233	
DIN-6923	234	
DIN-6923 A2	234	
DIN-1587	234	
DIN-125	235	
DIN-125 A2	235	
DIN-9021	236	
DIN-9021 A2	236	
DIN-127	237	

DIN-127 A2	237	
TU-MA	238	
DIN-6798 A	238	















Brocas, puntas y accesorios

B-HDS	240	
PU-PH	240	
PU-TO	240	
PU-OX	241	
PU-PO	241	
PU-CU	241	
BOCA	242	
PU-PM	242	
ATAP	242	
TP-CR B	243	
TP-CR N	243	
TP-TP	243	

Abrazaderas metálicas pesadas















AB-RA	248	
AB-IA	249	
AB-IR	249	
AB-RE	250	
AB-RE V	250	
AB-RE A2	251	
AB-RE A4	251	
AB-RI	252	
AB-RI V	252	
AB-RI A2	253	
AB-RI A4	253	
AB-RI DES	254	
PA-EX	254	
CO-AR	254	

GAMA COMPLETA INDEX A PERFECT FIXING



AB-ICP	254	
AB-AIS 13	255	
AB-AIS 19	255	
AB-AIS 30	255	
AB-AIS 40	255	
AB-GA	256	
AB-M8	256	
AB-DE Z	257	
AB-DE G	257	
AB-DP Z	257	
AB-DP G	257	
AB-ZI	258	
AB-ZI A2	258	
AB-SA	259	
AB-GP	259	

Abrazaderas metálicas ligeras





AB-M6	264	
AB-M6 Z	264	
AB-M6 A2	265	
AB-D6	265	
AB-D6 Z	265	
AB-6I	266	
AB-DI	266	
AB-M7 Z	267	
AB-D7 Z	267	
AB-7I Z	268	
AB-7ID Z	268	
AB-PI	269	
AB-PU	269	
AB-IP	270	
AB-SI	270	

AB-TO	270	
AB-SF	271	
AB-SF A2	271	
AB-SF IR	272	
AB-SF IRC	272	
AB-SF IRR	272	
CI-PE	272	
CI-PE A2	272	
AB-CR	273	
AB-ITS	273	
AB-ITD	273	
AB-BU	274	
AB-GM	274	
AB-GS	275	
AB-GD	275	









Sistemas de protección contra incendios

AB-PE	278		
AB-CH	278		 
AB-CI	279		
AN-CU	279		 

Soportes para canalones

TE-MO	282	
TE-GA	282	
TE-GR	282	
TE-PE	282	







Abrazaderas plásticas

BN-N	285		 
BN-B	286		 
BN-GR	287		
BN-VE	287		























GAMA COMPLETA INDEX A PERFECT FIXING















BN-MA	287		SP-Z	301	
BN-AM	287		SP-V	301	
BN-AZ	288		SP-H	302	
BN-RO	288		SP-HX	302	
BN-DT	288		TO-GU	302	
TACOBRI G	289		TO-GR	302	
BN-ID	289		TU-GU	302	
BN-PL	289		TU-GRA	303	
BN-BA	290		EG-Z	303	
AB-IN	290		EG-A2	303	
AB-ID	290		PU-Z	303	
AB-GU	291		PG-Z	303	
AB-MUG	291		PG-A2	303	
AB-PR	292		SO-TP	304	
AB-MS	292		GP-X 21	304	
AB-MD	292		GP-X 41	304	
AB-TS	293		SP-X	304	
AB-TD	293		SP-RX	304	
AB-TC	293		SP-UX	305	
FI-CA AB	294		PR-X	305	
FI-CA PS	294		RE-SX	305	
FI-CA PD	294		SO-TP	305	
FI-CA CL	294		TG-X	305	
GR-NY NT	295		TO-GRX	305	
Perfilería y soportación			TU-GX	306	
GP-Z	300		TU-MU	306	
GP-G	300		TU-RX	306	
GP-A2	300		TU-RXA	306	
GP-PL	300		SC-RX	307	
GP-PVC	300		EMP-X	307	
GL-O	301		RT-X	307	

GAMA COMPLETA INDEX A PERFECT FIXING





UN-PX	307	
UN-EX	307	
UN-TX	308	
PG-X	308	
AB-GX	308	
UN-CO	308	
SO-PG	308	

Sistemas de instalación y fijaciones para placas solares





KFR-SC	310	
PGS-A	310	
GP-XS	310	
EMP-XS	310	
NEW GP-VD	311	
PSA-A	311	
PSA-UN	311	
PSA-AV	311	
PSE-A	311	
PSE-UN	312	
NEW PSE-C	312	
NEW PSE-CUN	312	
KFS-FI	312	
KFS-FL	312	
TU-RX A2	313	
DIN-603 A2	313	
DIN-6921 A2	313	
DIN-6923 A2	313	
DIN-127 A2	313	
TPA-R	314	
TPA-P	314	
TRP-XS	314	

NU-XS	314	
KFS-MA	315	
KFS-AU	315	
KFS-RV	315	
GS-TC	316	
GS-TU	316	
STR	316	
PMO	316	
NEW PMO-L	316	
NEW MO-TL	317	
NEW MO-PC	317	
TAC + ARVUL	317	
TAC BIMETAL+ARVUL A2	317	
NEW AUE NI + ARVUL	317	
NEW DIN-7504-K RE NI + ARVUL	318	
RE-TE	318	
ARS-P	318	
ARS-S	318	
CS-B	318	





















Sistemas de fijación rápida en viga













SU-CL	322	
SU-VA	322	
SU-CU	323	
SU-AB	323	
SU-CA	323	

Varilla roscada y accesorios de fijación









RV-ZN	326	
RV-ZN 8.8	326	
RV-A2	326	
RV-2M	327	
VR-SE	327	

GAMA COMPLETA INDEX A PERFECT FIXING

MA-HE	327	
MA-RI	328	
MA-MH	328	
AR-FO	328	
GA-FO	329	
GE-SP	329	
AB-TA	329	
AB-TA B	329	
AB-TA A2	330	
AB-TR	330	
AB-PM7	330	
AB-TG	330	
TM-VR	330	
ES-DR	331	
ES-DA2	331	
AB-FP	331	
AB-FC	332	
PF-ZN	332	
PF-A4	332	
NEW ABE-RM	332	
NEW ABE-BO	332	

SA-LN	336	
SA-LH	336	
SA-IL	336	
SA-WZ	336	
SA-WL	336	
SA-CI	337	
SA-WH	337	
SA-WHM	337	
SA-TE TB	337	
SA-TE AL	337	
CO-SO	338	
CO-KS	338	
EasyKits	339	

Fijación para sanitarios y climatización

RA-TRG	334	
RA-TRI	334	
RA-FRE	334	
RA-FIN	334	
RA-RO	335	
RA-FEM	335	
RA-RAY	335	
RA-PES	335	



GAMA COMPLETA INDEX A PERFECT FIXING

Gama Inox

	MTP-A4		43			NEW GR-A4	129	
	MTH-A2		48			NEW GD-A4	130	
	MTH-A4		48			NEW GI-A4	131	
	DO-MT		51			DIN-7504-K A2	154	
NEW	TXE		54			ABE BIMETAL	157	
	CH-A2		61			ABE BIMETAL + ARVUL	157	
	CH-PI		62			AUTO BIMETAL	158	
	CH-GF A2		64			AUTO BIMETAL + ARVUL	158	
	CH-AF A2		65			PS 3 + ARVUL A2	160	
	HE-A4		67			PS 5 + ARVUL A2	160	
	HE-C4		67			ARVUL A2	161	
	AC-CI		71			NEW ARPAP A2	161	
	HI-CI		74			DIN-7504-N HP A2	165	
	AVR		75			RS-A2	169	
	AVC		75			BCP A2	170	
	EQ-A2		83			CP-A2	175	
	EQ-A4		83			TEX-A2	183	
	T-NUX A A4		95			TP-A2	193	
	T-NUX E A4		96			DIN-571 A2	195	
	TC-A2		98			INV A2	196	
	RE-IN		119			DIN-933 A2	224	
NEW	SJ-A4		124			DIN-6921 A2	226	
NEW	SJ-PS A4		125			DIN-603 A2	229	
NEW	SJ-PD A4		125			DIN-934 A2	232	
NEW	TS-GA A4		126			DIN-985 A2	233	
NEW	TS-AA A4		126			DIN-6923 A2	234	
NEW	TS-GG A4		127			DIN-125 A2	235	
NEW	EV-H A4		128			DIN-9021 A2	236	
NEW	EV-M A4		128			DIN-127 A2	237	



Handwriting practice area consisting of 20 horizontal dotted lines.

A
PERFECT
FIXING

CATINSIN23

INDEX[®]
A PERFECT FIXING

Técnicas Expansivas S.L.

P. I. La Portalada II, C/ Segador, 13
26006 · Logroño (La Rioja) · SPAIN

T. (+34) 941.272.131 · E. info@indexfix.com
www.indexfix.com