







L'AZIENDA.

Dal 1970, IDRAL si dedica alla progettazione e produzione di rubinetti e prodotti sanitari per ambienti aperti al pubblico.

*L'azienda vanta una solida esperienza, competenze manifatturiere all'avanguardia e tutta l'agilità necessaria per soddisfare le esigenze di un mercato sempre più competitivo, sia in termini di **qualità** che di **time-to-market**.*

THE COMPANY.

IDRAL has been engaged in the design and production of taps and sanitary products for public and commercial places since 1970.

The company boasts a solid experience, manufacturing expertise and all the agility necessary to meet the needs of an increasingly competitive environment, both in terms of **quality** and **time-to-market**.

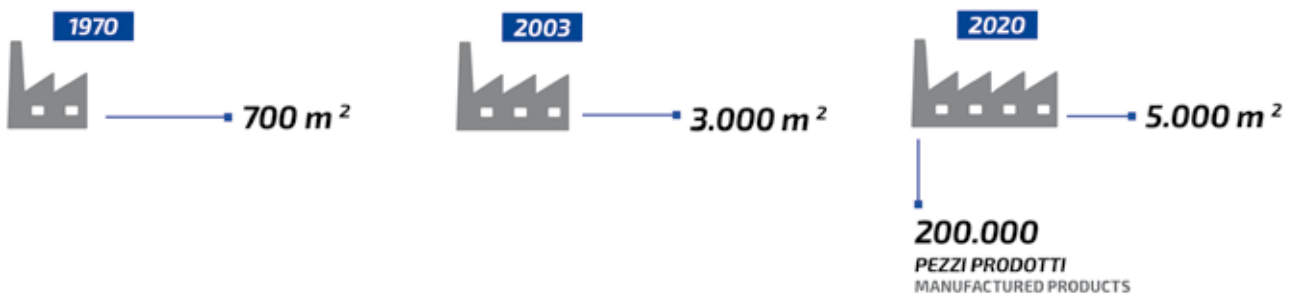

Ing. VITTORIO VASCONI
Presidente
Chairman

RICCARDO POLETTI
Direttore commerciale
e marketing
Head of Sales and Marketing





Ing. ANNA CHIARA VASCONI
*Direttore amministrativo
e risorse umane*
Head of administration and HR

Ing. JUERGEN SCHWEITZER
Direttore Industriale
Head of Operations





**PERSONE.
SOLUZIONI.**

Progettiamo, produciamo e forniamo soluzioni idrosanitarie in tutto il mondo. **Ogni giorno.**



PEOPLE. SOLUTIONS.

We design, manufacture and supply hydrosanitary solutions around the world. **Everyday.**



IDRAL. LA QUALITÀ.

La nostra strategia aziendale, volta al raggiungimento di elevati standard qualitativi, comprende anche il nostro stabilimento, dotato delle tecnologie più all'avanguardia, che si sviluppa su un'area di 12.000 metri quadrati.

Qui le più sofisticate attrezzature consentono la progettazione e la realizzazione di prodotti innovativi nel design e nel valore tecnologico.

L'obiettivo di Idral è quello di realizzare una produzione di alto livello, per assicurare la migliore qualità ed un servizio di eccellenza ai propri clienti.

La qualità e i materiali di produzione della rubinetteria Idral, costantemente monitorata e testata, sono comprovati da varie certificazioni internazionali, che ne attestano l'elevato standard, tra queste ISO 9001:2015, EN 12164 e EN 12168:98 per gli articoli torniti, EN 12165 per gli articoli stampati e EN 1982:2001 per tutta la produzione di fonderia.

IDRAL. THE QUALITY.

IDRAL's corporate strategy, aimed at achieving high quality standards, includes our 12,000 square meters factory equipped with the latest technology.

Here the most sophisticated equipment enable to design and to manufacture innovative products.

IDRAL's goal is obtaining a high level production in order to guarantee the greatest quality and an excellent customer satisfaction.

The quality of materials and the production are constantly checked, tested and guaranteed by several international certifications that endorse our high quality, including the ISO 9001:2015, EN 12164 and EN 12168:98 for turned items, EN 12165 for pressed items and EN 1982:2001 for all foundry production.



ACS



Unified
Water Label



CE

Marchatura CE
per garantire prodotti sicuri, conformi
alle norme Europee. (Reg. UE n. 305/2011)

CE marking
to ensure safe, compliant products
to European standards. (EU Reg. No. 305/2011)

REFERENZE REFERENCES

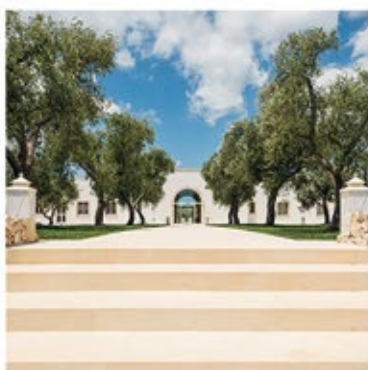

*Masseria Muntibianchi, Puglia
(Italia)*
Masseria Muntibianchi, Apulia (Italy)



Fiera di Bologna (Italia)
Bologna Exhibition Center (Italy)



Ristorante Frères Gourmets
Casablanca (Marocco)



Oyala Towers (Arabia Saudita)
Oyala Towers (Saudi Arabia)

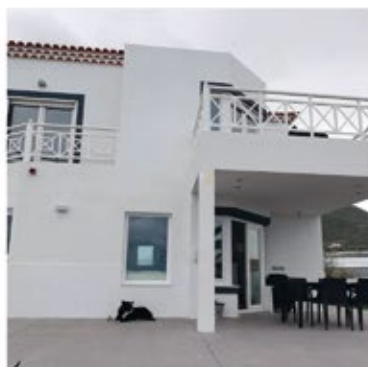

Residenza privata (Spagna)
Private residence (Spain)



Hotel Ponta Negra (Brasile)
Ponta Negra Hotel (Brasil)

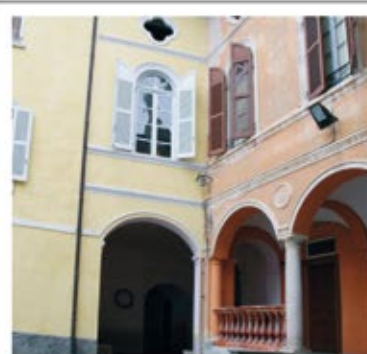

*Casa Di Cura SS. Filippo E Giorgio
Valduggia (Italia)*
SS. Filippo E Giorgio Nursing Home
Valduggia (Italy)

Bagni per anziani

*- Soluzione completa:
Lavabi ergonomici su barra di sostegno
ribaltabile, miscelatori a leva clinica,
WC per anziani, doccette igieniche,
miscelatori termostatici, ausili per doccia
e maniglioni di supporto, piatti doccia in
vetroresina a filo pavimento.*

Bathrooms for the elderly

*- Complete solution:
Ergonomic washbasins on tilting support,
clinic lever mixers, WC for elderly people,
hygienic showers, thermostatic mixers,
shower aids and support grab bars, floor-
level fiberglass shower plates.*

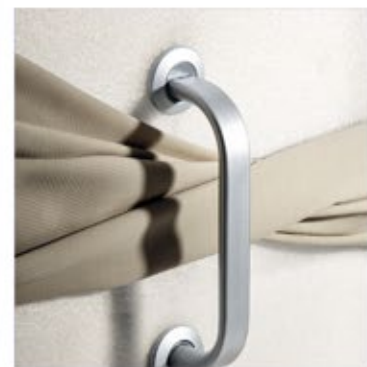



Asilo Piccinelli, Varese (Italia)
Piccinelli Kindergarten, Varese (Italy)



Ospedale Maggiore Ca' Granda, Milano (Italia)
Maggiore Ca' Granda Hospital, Milan (Italy)



Aeroporto di Mascate (Oman)
Mascate Airport (Oman)

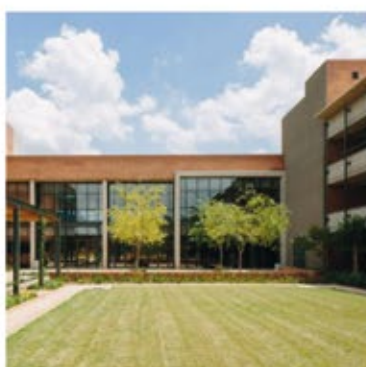

Osp. pediatrico "Nelson Mandela" (Sud Africa)
"Nelson Mandela" children's hospital (South Africa)



Joy Coffee & Green, Castelletto Ticino (Italia)

Joy Coffee & Green,
Castelletto Ticino (Italy)

Bagni Ristorazione

- *Intervento con rubinetti elettronici a parete e miscelatori elettronici per lavabo e soluzione completa per il bagno per disabili (lavabi, wc, maniglioni)*

Restaurant Bathrooms

- *Interventions: wall-mounted electronic faucets and electronic mixers for washbasin and complete bathroom solutions for people with reduced mobility (washbasins, toilets, grab bars)*



Impianto Sportivo, Ponzano Veneto (Italia)
Sports Centre, Ponzano Veneto (Italy)



Camping Village, Dormelletto, Lago Maggiore (Italia)

Camping Village, Dormelletto,
Lake Maggiore (Italy)

Infrastruttura Turistica

- *Progetto completo: docce e lavapiedi temporizzati, soffioni doccia antivandalo, miscelatori elettronici antilegionella per lavabi e rubinetti elettronici KIDS per i bagni dei bambini.*

Tourist accomodation

- *Complete project: timed showers and foot washers, vandal-proof shower heads, anti-legionella electronic mixers for washbasins and KIDS electronic taps for children's bathrooms.*



Stadio Olimpico, Barcellona (Spagna)
Olympic Stadium, Barcelona (Spain)



Chiesa di Pretoria (Sud Africa)
Pretoria Church (South Africa)



Area attrezzata, Vipiteno (Italia)
Equipped Area, Vipiteno (Italy)



Ospedali Riuniti, Reggio C. (Italia)
Riuniti Hospital in Reggio Calabria (Italy)



Centro l'Aurora, Gozzano (Italia)
L'Aurora Centre, Gozzano (Italy)



The Style outlets, Vicolungo (Italia)
The Style outlets, Vicolungo (Italy)

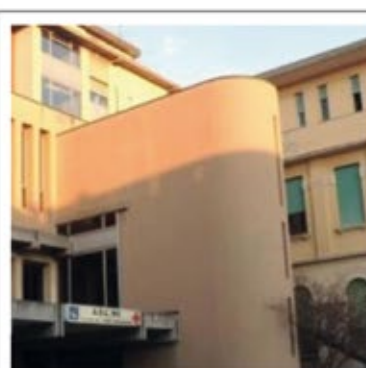

Ospedale Ss.Trinità, Borgomanero (Italia)

Holy Trinity Hospital,
Borgomanero (Italy)

Bagni Pediatria

- Miscelatori per lavabo della serie KIDS disegnati per le esigenze dei bambini.

Paediatric bathrooms

- KIDS series washbasin mixers designed for children's needs.



Hotel Splendid, Baveno (Italia)
Hotel Splendid, Baveno (Italy)



Asilo di Mesenzana, Varese (Italia)
Kindergarten of Mesenzana, Varese (Italy)



Circolo Nautico Telimar (Sicilia)
Yacht Club Telimar, Sicily (Italy)



Techno Hub Trading LLC., Dubai (Emirati Arabi Uniti)
Techno Hub Trading LLC., Dubai (UAE)



NEW



serie 700



serie 700



serie 84

serie 700



serie 70

10575/E





pannelli doccia



NEW



cucina

LA SCATOLA AD INCASSO IL SEGRETO DELLA FACILE INSTALLAZIONE E DELLA MODULARITÀ

La caratteristica distintiva di questa serie è l'intercambiabilità dei dispositivi, attraverso l'aggancio tra la scatola e le parti tecniche di funzionamento progettato in modo che le due parti possano essere installate in tempi diversi o che comunque ci sia sempre la possibilità di cambiare il tipo di dispositivo all'interno della scatola anche dopo l'incasso nel muro, a condizione che il nuovo dispositivo rispetti gli allacciamenti idrici del precedente. La scatola garantisce l'isolamento stagno del muro nel quale viene incassato il rubinetto, qualsiasi traccia d'acqua (perdita, umidità) viene espulsa all'esterno della parete mediante un canale di scarico appositamente studiato.

THE WALL-MOUNTED BOX MAKE INSTALLATION EASY FOR A VERSATILE SOLUTION

The distinctive feature of this series is the interchangeability of the devices, through the lock between the box and the technical operating parts, prepared to be installed at different times. Besides, there is always the possibility of changing the type of tap hooked to the box even after it is installed into the wall, whenever the new product respects the water connections of the previous one. The box guarantees the watertight insulation of the wall in which the tap is embedded, any trace of water (leakage, humidity) is expelled outside the wall through a specially designed drain channel.

LA BOÎTE EMPOTRÉE UNE INSTALLATION FACILE POUR UNE SOLUTION POLYVALENTE

La particularité de cette série est l'interchangeabilité des dispositifs, par l'accouplement entre la boîte et le robinet de sorte que les deux parties puissent être installées à des moments différents ou qu'en tout cas il y ait toujours la possibilité de changer le type de robinet à l'intérieur de la boîte même après son encastrement dans le mur à condition que le nouveau robinet respecte les raccordements d'eau du précédent. La boîte garantit une isolation étanche du mur dans lequel est encastré le robinet, toute trace d'eau (fuite, humidité) est expulsée à l'extérieur du mur par une rigole d'évacuation.

LA CAJA EMPOTRADA FACILITA LA INSTALACIÓN PARA UNA SOLUCIÓN VERSÁTIL

La característica distintiva de esta serie es la intercambiabilidad de los aparatos, mediante el acoplamiento entre la caja de empotrar y el grifo de forma que las dos partes pueden instalarse en momentos diferentes o en todo caso siempre existe la posibilidad de cambiar el tipo de grifo dentro de la caja incluso después de empotrar en la pared a condición de que el nuevo grifo respete las conexiones de agua del anterior. La caja garantiza el aislamiento estanco de la pared en la que se empotra la grifería, cualquier resto de agua (fugas, humedad) es expulsada al exterior de la pared a través de un canal de desagüe.

Guarnizione a tenuta stagna
Watertight o-ring
Joint étanche
Sello hermético



Livelle incorporate per un montaggio facilitato
Built-in levels for easier assembly
Niveaux à bulle intégrés pour un montage facile
Niveles de burbuja incorporados para un fácil montaje

INSTALLAZIONE • INSTALLATION • INSTALLATION • INSTALACIÓN

1

Installare la scatola
Install the box
Installer la boîte
Instalar la caja

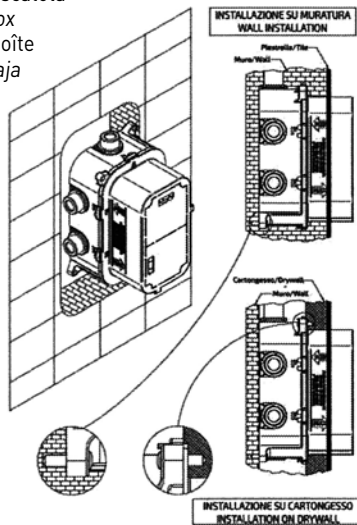

2

Tagliare il coperchio
Cut the top
Couper le couvercle
Cortar la tapa

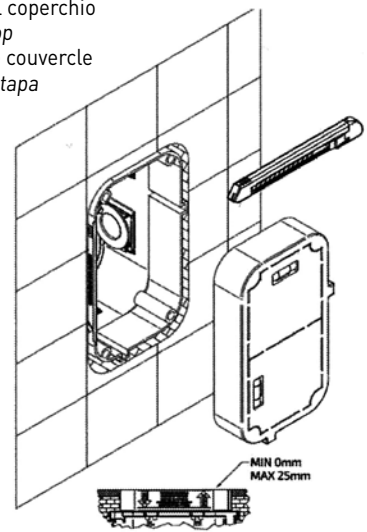

3

Installare le parti interne
Install the internal parts
Installer les pièces internes
Instalar las piezas internas

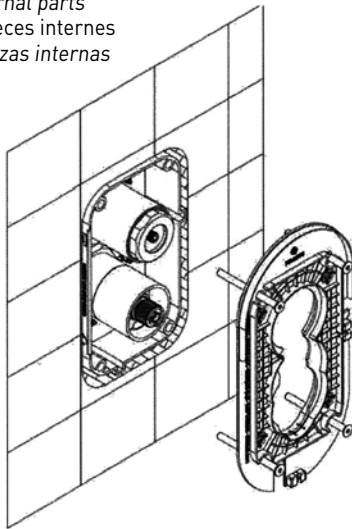

4

Fissare la piastra cromata
Fix the chrome plate
Fixer la plaque chromée
Fijar la placa cromada

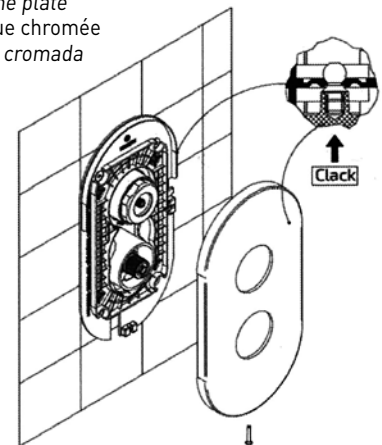

5

Completare l'installazione
Complete the installation
Terminer l'installation
Completar la instalación

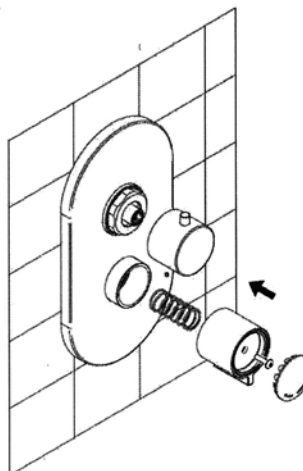



kids





**01210**

Rubinetto lavabo serie KIDS
 Basin single tap KIDS series
 Robinet de lavabo série KIDS
 Grifo para lavabo colección KIDS

01210/PT

Con premiscelatore termostatico
 With thermostatic pre-mixer
 Avec pré-mitigeur thermostatique
 Con pre-mezclador termostático

01212

Miscelatore lavabo serie KIDS
 Basin mixer KIDS series
 Mitigeur de lavabo série KIDS
 Mezclador para lavabo colección KIDS

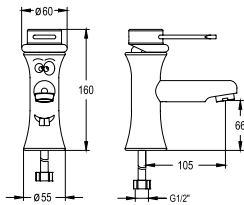

ART.	FINISHING	PACK.
01210	COLOR	1
01210/PT	COLOR	1
01212	COLOR	1

**01250**

Rubinetto elettronico lavabo con alimentazione a batteria serie KIDS
 Electronic basin tap battery operated KIDS series
 Robinet de lavabo électronique alimentation à piles série KIDS
 Grifo electrónico para lavabo alimentación con batería colección KIDS

01250/PT

Con premiscelatore termostatico
 With thermostatic pre-mixer
 Avec pré-mitigeur thermostatique
 Con pre-mezclador termostático

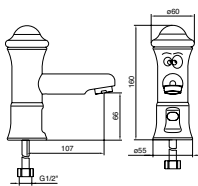

ART.	FINISHING	PACK.
01250	COLOR	1
01250/PT	COLOR	1

**01220**

Rubinetto lavabo a parete serie KIDS
 Wall mounted basin single tap KIDS series
 Robinet de lavabo mural série KIDS
 Grifo de pared para lavabo colección KIDS

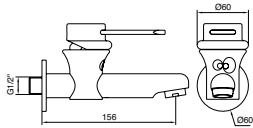

ART.	FINISHING	PACK.
01220	COLOR	1

**01221**

Miscelatore lavabo a parete serie KIDS
 Wall mounted basin mixer KIDS series
 Mitigeur de lavabo mural série KIDS
 Mezclador para lavabo colección KIDS

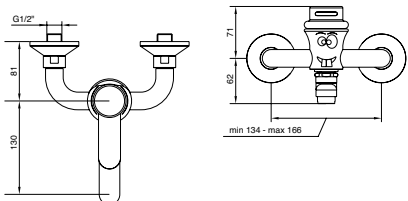

ART.	FINISHING	PACK.
01221	COLOR	1

**10392**

Lavabo in ceramica serie KIDS
 Ceramic basin KIDS series
 Lavabo en céramique série KIDS
 Lavabo en cerámica colección KIDS

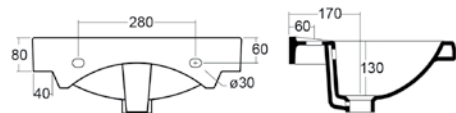
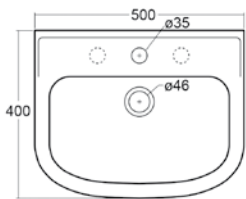

ART.	FINISHING	PACK.
10392	WHITE	1

11306

Sedile rosso/giallo per vasi art. 10302-10306 serie KIDS
 Red/yellow seat cover for WC art. 10302-10306 KIDS series
 Abattant WC rouge/jaune pour cuvettes art. 10302-10306 série KIDS
 Asiento rojo/amarillo para inodoro 10302-10306 colección KIDS

**11306B**

Sedile bianco per vasi art 10302-10306 serie KIDS
 White seat cover for WC art. 10302-10306 KIDS series
 Abattant WC blanc pour cuvettes art. 10302-10306 série KIDS
 Asiento blanco para inodoro 10302-10306 colección KIDS

ART.	FINISHING	PACK.
11306	COLOR	1
11306B	WHITE	1

**10306**

Vaso in ceramica scarico a terra serie KIDS
 Ceramic wc floor discharge KIDS series
 Cuvette en céramique évacuation au sol série KIDS
 Inodoro en cerámica con desagüe al suelo colección KIDS

10316

Vaso in ceramica, scarico a parete serie KIDS
 Ceramic wc, wall discharge KIDS series
 Cuvette en céramique, évacuation au mur série KIDS
 Inodoro en cerámica con desagüe a pared colección KIDS

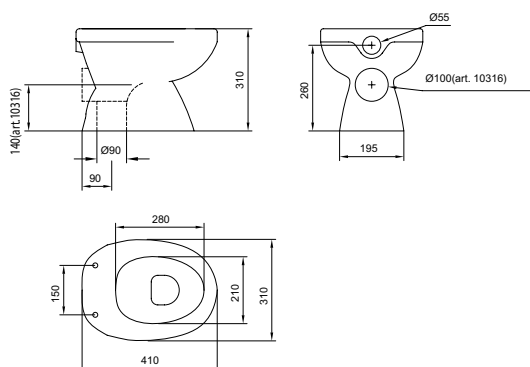

ART.	FINISHING	PACK.
10306	WHITE	1
10316	WHITE	1

**10302**

Vaso sospeso in ceramica serie KIDS
 Ceramic wall hung WC KIDS series
 Cuvette suspendue en céramique série KIDS
 Inodoro suspendido en cerámica colección KIDS

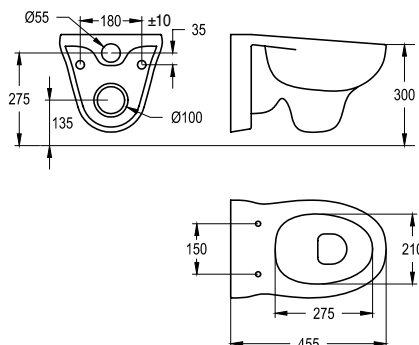

ART.	FINISHING	PACK.
10302	WHITE	1
15105/2	WHITE	1



life





PROGETTAZIONE DI SERVIZI IGIENICI PER DIVERSAMENTE ABILI

Al momento della redazione del presente documento, la legislazione italiana, nell'ambito della progettazione edilizia per l'abbattimento delle barriere architettoniche prevede essenzialmente due decreti ufficiali:

- D.M. 14 giugno 1989, n° 236

“Prescrizioni tecniche necessarie a garantire l'accessibilità, l'adattabilità e la visitabilità degli edifici privati e di edilizia residenziale pubblica sovvenzionata e agevolata, ai fini del superamento e dell'eliminazione delle barriere architettoniche.”

- D.P.R. 24 luglio 1996, n° 503

“Regolamento recante norme per l'eliminazione delle barriere architettoniche negli edifici, spazi e servizi pubblici.”

Le prescrizioni dimensionali per la progettazione e realizzazione dei passaggi obbligati e degli spazi di manovra atti a garantire l'accesso ai locali igienici da parte dei soggetti diversamente abili, in particolare a quelli su sedia a ruote, sono riportate nel DM 236/89 ai punti 4.1.6, 8.0.2. e 8.1.6, ai quali fa riferimento anche il successivo DPR 503/96.

Le suddette norme sono valide a livello nazionale, ma esistono specifiche e integrazioni legislative a livello regionale che devono essere valutate in fase di progettazione; consigliamo quindi di interpellare le A.S.L. di competenza per avere eventuali delucidazioni.

Estratti da DM 236/89

Capo I Generalità

Art. 1 - Campo di Applicazione

Le norme contenute nel presente decreto si applicano:

- 1) agli edifici privati di nuova costruzione, residenziali e non, ivi compresi quelli di edilizia residenziale convenzionata;
- 2) agli edifici di edilizia residenziale pubblica sovvenzionata ed agevolata, di nuova costruzione;
- 3) alla ristrutturazione degli edifici privati di cui ai precedenti punti 1) e 2), anche se preesistenti alla entrata in vigore del presente decreto;
- 4) agli spazi esterni di pertinenza degli edifici di cui ai punti precedenti.

Art. 2 - Definizioni

Ai fini del presente decreto:

A) Per barriere architettoniche si intendono:

- a) gli ostacoli fisici che sono fonte di disagio per la mobilità di chiunque ed in particolare di coloro che, per qualsiasi causa, hanno una capacità motoria ridotta o impedita in forma permanente o temporanea;
- b) gli ostacoli che limitano o impediscono a chiunque la comoda e sicura utilizzazione di parti, attrezzature o componenti;
- c) la mancanza di accorgimenti e segnalazioni che permettono l'orientamento e la riconoscibilità dei luoghi e delle fonti di pericolo per chiunque e in particolare per i non vedenti, per gli ipovedenti e per i sordi.

[omissis...]

- G) Per accessibilità si intende la possibilità, anche per persone con ridotta o impedita capacità motoria o sensoriale, di raggiungere l'edificio e le sue singole unità immobiliari e ambientali, di entrarvi agevolmente e di fruirne spazi e attrezzature in condizioni di adeguata sicurezza e autonomia.
- H) Per visitabilità si intende la possibilità, anche da parte di persone con ridotta o impedita capacità motoria o sensoriale, di accedere agli spazi di relazione e ad almeno un servizio igienico di ogni unità immobiliare. Sono spazi di relazione gli spazi di soggiorno o pranzo dell'alloggio e quelli dei luoghi di lavoro, servizio ed incontro, nei quali il cittadino entra in rapporto con la funzione ivi svolta.
- I) Per adattabilità si intende la possibilità di modificare nel tempo lo spazio costruito a costi limitati, allo scopo di renderlo completamente ed agevolmente fruibile anche da parte di persone con ridotta o impedita capacità motoria o sensoriale.

[omissis...]

Capo II Criteri di progettazione

[omissis...]

4.1.6 Servizi igienici

Nei servizi igienici devono essere garantite, con opportuni accorgimenti spaziali, le manovre di una sedia a ruote necessarie per l'utilizzazione degli apparecchi sanitari.

Deve essere garantito in particolare:

- lo spazio necessario per l'accostamento laterale della sedia a ruote alla tazza e, ove presenti, al bidet, alla doccia, alla vasca da bagno, al lavatoio alla lavatrice;
- lo spazio necessario per l'accostamento frontale della sedia a ruote al lavabo, che deve essere del tipo a mensola;
- la dotazione di opportuni corrimano e di un campanello di emergenza posto in prossimità della tazza e della vasca.

Si deve dare preferenza a rubinetti con manovra a leva e, ove prevista, con l'erogazione dell'acqua calda regolabile mediante miscelatori termostatici, e a porte scorrevoli o che aprono verso l'esterno.

(Per le specifiche vedi 8.1.6).

Capo IV Specifiche e soluzioni tecniche

[omissis...]

8.0.2 Spazi di manovra con sedia a ruote

Gli spazi di manovra, atti a consentire determinati spostamenti alla persona su sedia a ruote, sono i seguenti:

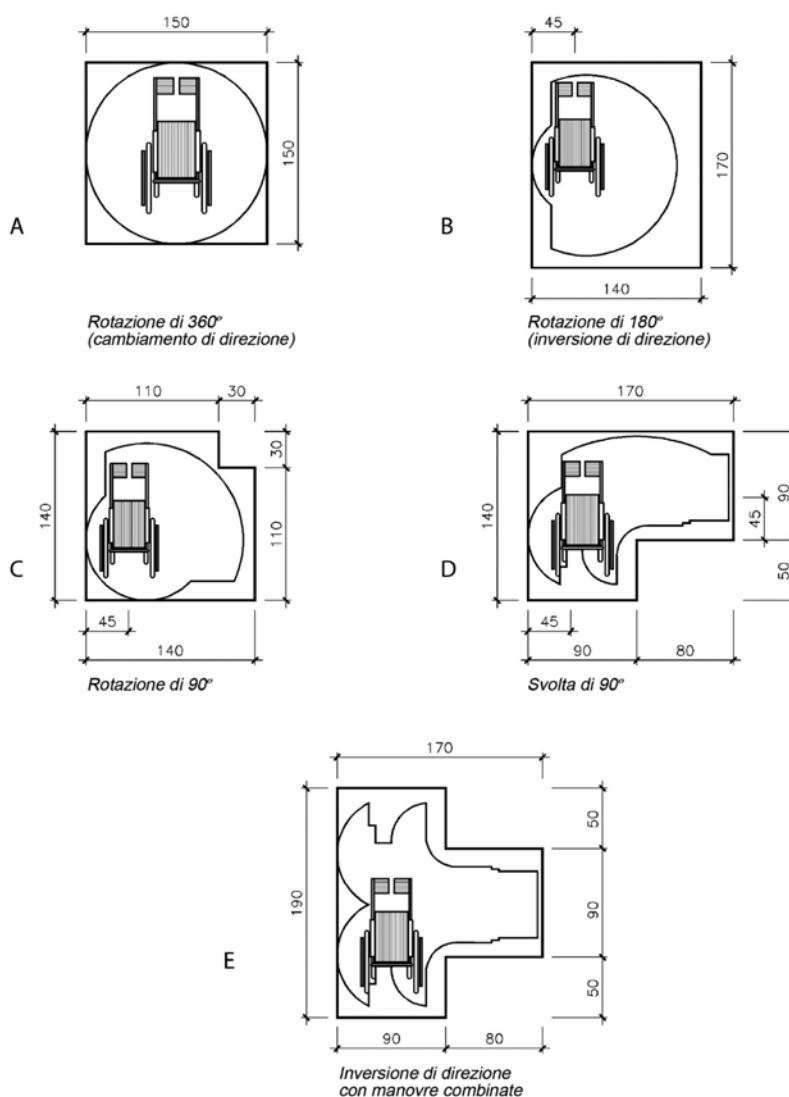

8.1.6 Servizi igienici

Per garantire la manovra e l'uso degli apparecchi anche alle persone con impedita capacità motoria, deve essere previsto, in rapporto agli spazi di manovra di cui al punto 8.0.2, l'accostamento laterale alla tazza w.c., bidè, vasca, doccia, lavatrice e l'accostamento frontale al lavabo.

A tal fine devono essere rispettati i seguenti minimi dimensionali:

- lo spazio necessario all'accostamento e al trasferimento laterale dalla sedia a ruote alla tazza w.c. e al bidet, ove previsto, deve essere minimo 100 cm misurati dall'asse dell'apparecchio sanitario;
- lo spazio necessario all'accostamento laterale della sedia a ruote alla vasca deve essere minimo di 140 cm lungo la vasca con profondità minima di 80 cm;
- lo spazio necessario all'accostamento frontale della sedia a ruote al lavabo deve essere minimo di 80 cm misurati dal bordo anteriore del lavabo.

Relativamente alle caratteristiche degli apparecchi sanitari inoltre:

- i lavabi devono avere il piano superiore posto a cm 80 dal calpestio ed essere sempre senza colonna con sifone preferibilmente del tipo accostato o incassato a parete;
- i w.c. e i bidet preferibilmente sono del tipo sospeso, in particolare l'asse della tazza w.c. o del bidet deve essere posto ad una distanza minima di cm 40 dalla parete laterale, il bordo anteriore a cm 75-80 dalla parete posteriore e il piano superiore a 45-50 cm dal calpestio. Qualora l'asse della tazza - w.c. o bidet sia distante più di 40 cm dalla parete, si deve prevedere, a cm 40 dall'asse dell'apparecchio sanitario un maniglione o corrimano per consentire il trasferimento;
- la doccia deve essere a pavimento, dotata di sedile ribaltabile e doccia a telefono;

Negli alloggi accessibili di edilizia residenziale sovvenzionata di cui al capo II art. 3 deve inoltre essere prevista l'attrezzabilità con maniglioni e corrimano orizzontali e/o verticali in vicinanza degli apparecchi; il tipo e le caratteristiche dei maniglioni o corrimano devono essere conformi alle specifiche esigenze riscontrabili successivamente all'atto dell'assegnazione dell'alloggio e posti in opera in tale occasione.

Nei servizi igienici dei locali aperti al pubblico è necessario prevedere e installare il corrimano in prossimità della tazza w.c., posto ad altezza di cm 80 dal calpestio, e di diametro cm 3 - 4; se fissato a parete deve essere posto a cm 5 dalla stessa. Nei casi di adeguamento è consentita la eliminazione del bidet e la sostituzione della vasca con una doccia a pavimento al fine di ottenere anche senza modifiche sostanziali del locale, uno spazio laterale di accostamento alla tazza w.c. e di definire sufficienti spazi di manovra.

Negli alloggi di edilizia residenziale nei quali è previsto il requisito della visitabilità, il servizio igienico si intende accessibile se è consentito almeno il raggiungimento di una tazza w.c. e di un lavabo, da parte di persona su sedia a ruote. Per raggiungimento dell'apparecchio sanitario si intende la possibilità di arrivare sino alla diretta prossimità di esso, anche senza l'accostamento laterale per la tazza w.c. e frontale per il lavabo.

ESEMPIO BAGNO (MINIMO) SECONDO D.M. 236/89



Figura 1



Figura 2

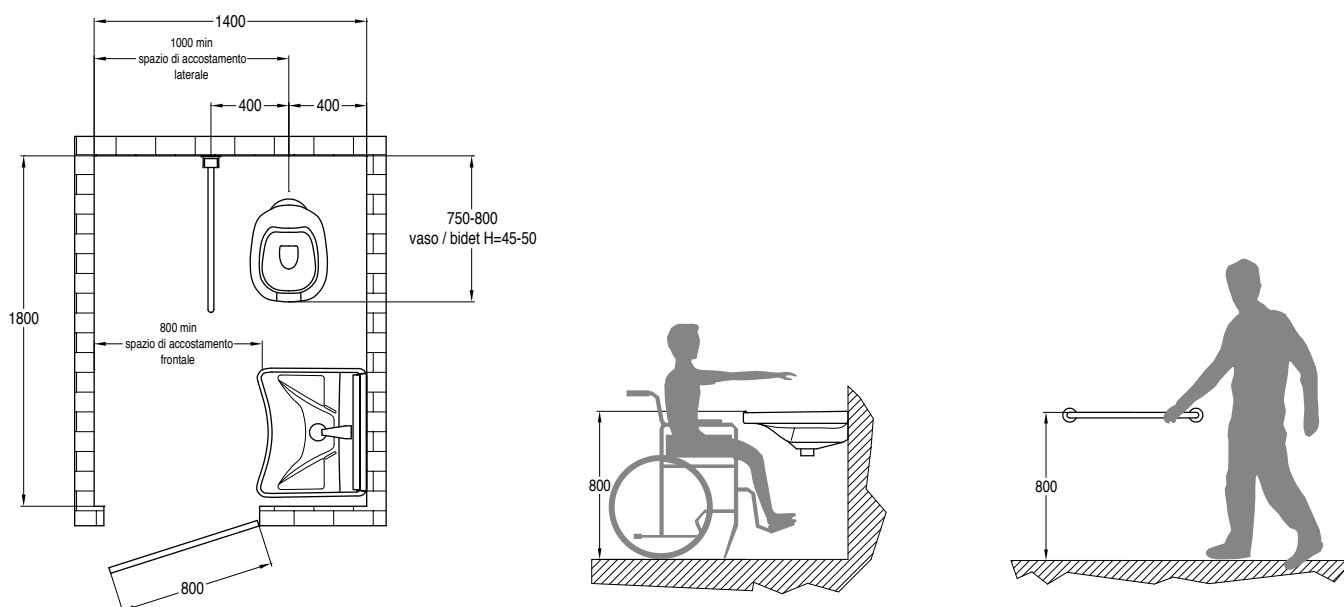

Figura 1

RIF.	ART.	DESCRIZIONE / DESCRIPTION	QUANTITA' / QUANTITY
1	10242	Vaso monoblocco per disabili / Monoblock WC for disabled people	1
2	11200	Sedile per vaso disabili / Cover seat for wc for disabled people	1
3	15410	Batteria di scarico pneumatica / Pneumatic drain set	1
4	15405	Comando pneumatico da incasso per cassetta WC / Concealed pneumatic control for wc tank	1
5	10192	Lavabo ergon. disabili / Ergonomic wash basin for disabled people	1
6	15102	Mensola pneumatica per lavabo / Bending pneumatic shelf for basin	1
7	02512	Miscelatore a fotocellula / Electronic mixer	1
8	15407	Kit scarico incasso / Drain kit with waste	1
9	12010V	Specchio reclinabile / Adjustable mirror	1
10	12001V-DX	Manigl. montante destro / Vertical angle bar right hand	2
11	12007.2	Sedile ribaltabile con gambe / Shower folding seat with legs	1
12	15201	Piatto doccia filo pav. 90x90 / Fiberglass floor level shower tray 90x90	1
13	15600	Piletta scarico / Drain for fiber glass shower tray	1
14	12005V-80	Ribaltabile cm 80 / Folding supporting bar cm.80	1

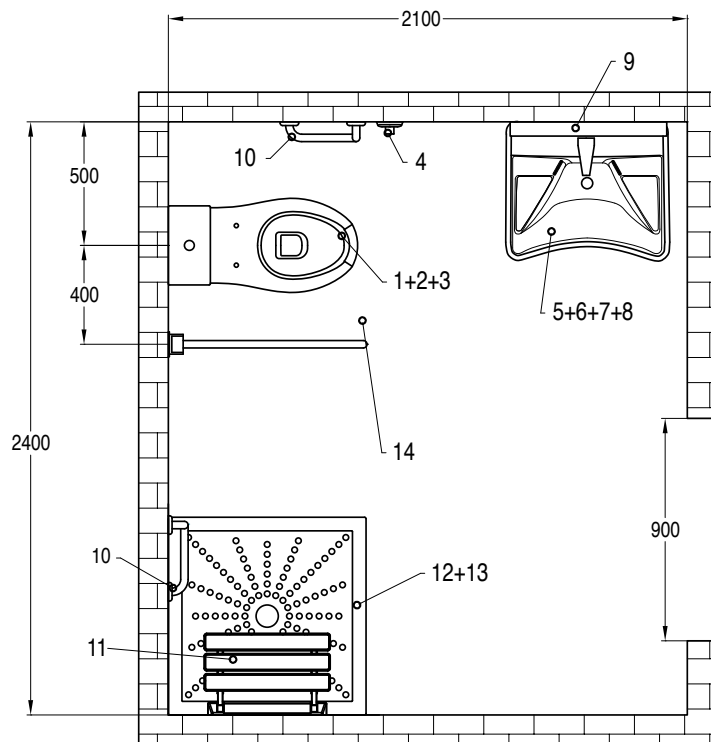
Figura 2

RIF.	ART.	DESCRIZIONE / DESCRIPTION	QUANTITA' / QUANTITY
1	12005V-80	Ribaltabile vern. 80 cm / Folding supporting bar cm.80	1
2	10200 10210	Vaso disabili scarico terra / WC floor discharge for disabled people Vaso disabili scarico parete / WC wall discharge for disabled people	1
3	11200	Sedile per vaso disabili / Cover seat for wc for disabled people	1
4	12000V-45	Maniglione lineare 45 cm / Linear handbar 45 cm	1
5	10192	Lavabo disabili / Ergonomic wash basin for disabled people	1
6	15100	Mensola per lavabo fissa / Fixed shelf for basin	1
7	15408	Sifone esterno c/tubo corrugato e piletta / External siphon w/wrinkled pipe and external trap	1
8	12010V	Specchio reclinabile / Adjustable mirror	1
9	02475	Miscelatore monocomando con leva clinica / Clinical lever basin mixer	1
10	15404	Comando pneumatico a parete per cassetta WC / Pneumatic wall control for wc tank	1
11	12000V-60	Maniglione lineare 60 cm / Linear handbar 60 cm	1

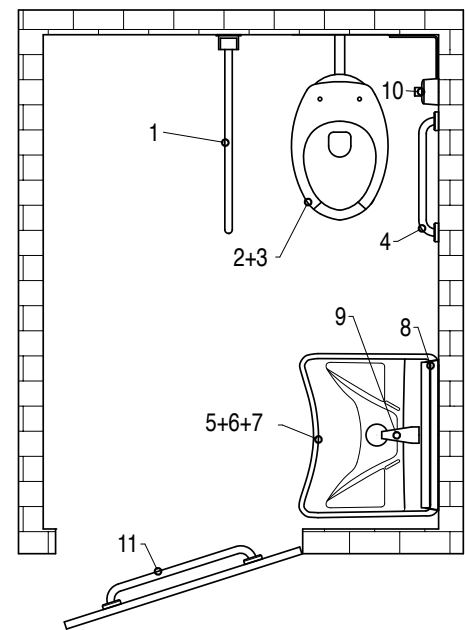
**10191**

Lavabo ergonomico in ceramica, con troppopieno serie EASY

Ergonomic ceramic basin with overflow EASY series

Lavabo ergonomique en céramique, avec trop plein série EASY

*Lavabo ergonómico de cerámica, con rebosadero colección EASY***10191PLT**

Lotto minimo 8 pz

Minimum batch 8 pcs

Minimum 8 pièces

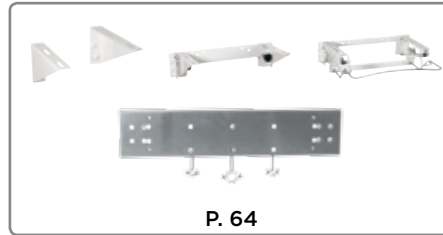
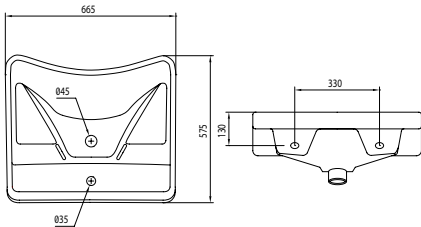
Lote mínimo 8 piezas

ART.	FINISHING	PACK.
10191	WHITE	1
10191PLT	WHITE	1

**10192**

Lavabo ergonomico in ceramica, senza troppopieno serie EASY

Ergonomic ceramic basin without overflow EASY series

Lavabo ergonomique en céramique, sans trop plein série EASY

*Lavabo ergonómico de cerámica, sin rebosadero colección EASY***10192PLT**

Lotto minimo 8 pz

Minimum batch 8 pcs

Minimum 8 pièces

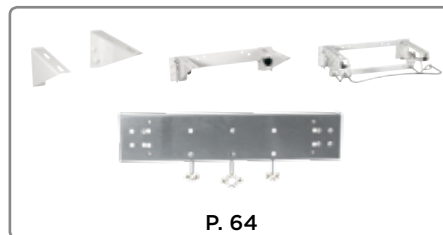
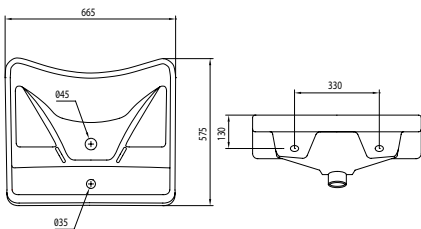
Lote mínimo 8 piezas

ART.	FINISHING	PACK.
10192	WHITE	1
10192PLT	WHITE	1

**10395**

Lavabo a canale in ceramica da cm 120 serie KIDS
 Ceramic washing trough 120 cm KIDS series
 Lavabo-rigole en céramique 120 cm série KIDS
 Lavabo colectivo en cerámica 120 cm colección KIDS

10395/1

Lavabo a canale in ceramica da cm 90 serie KIDS
 Ceramic washing trough 90 cm KIDS series
 Lavabo-rigole en céramique 90 cm série KIDS
 Lavabo colectivo en cerámica 90 cm colección KIDS

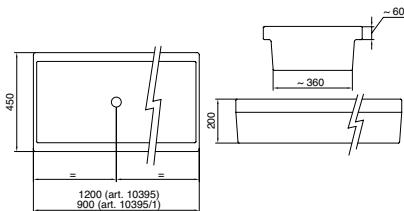

ART.	FINISHING	PACK.
10395	WHITE	1
10395/1	WHITE	1

**10396**

Lavabo ergonomico con troppopieno serie HOME
 Ergonomic basin with overflow HOME series
 Lavabo ergonomique avec trop plein série HOME
 Lavabo ergonómico con rebosadero colección HOME

10396PSL

Porta asciugamani laterale cromato
 Chromed lateral towel rail
 Porte serviette latérale chromé
 Toallero lateral cromado

10396PSF

Porta asciugamani frontale cromato
 Chromed frontal towel rail
 Porte serviette frontale chromé
 Toallero frontal cromado

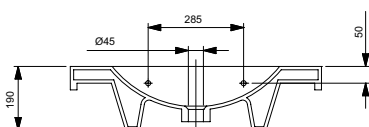
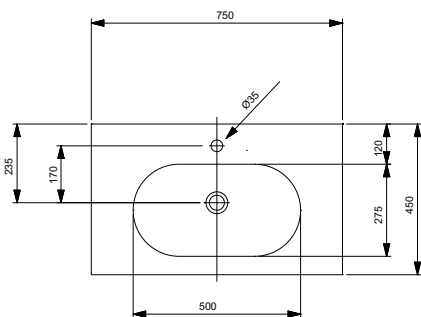

ART.	FINISHING	PACK.
10396	WHITE	1
10396PSL	CHROME	1
10396PSF	CHROME	1



**10200**

Unified Water Label 4,5 l

Vaso in ceramica H=49 cm, con apertura frontale e scarico a terra serie EASY
 Ceramic WC H=49 cm with front opening and floor discharge EASY series
 Cuvette en céramique H=49cm avec ouverture frontale et évacuation au sol série EASY
 Inodoro en cerámica H=49cm con apertura frontal y desagüe suelo colección EASY

10200PLT

Lotto minimo 8 pz
 Minimum batch 8 pcs
 Minimum 8 pièces
 Lote mínimo 8 piezas

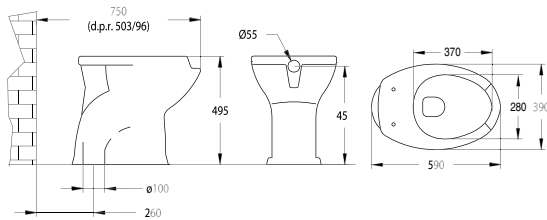
**11200 - P. 58****15409/4**

ART.	FINISHING	PACK.
10200	WHITE	1
10200PLT	WHITE	1
11200	WHITE	1
15409/4		1

**10210**

Unified Water Label 4,5 l

Vaso in ceramica H=49 cm, con apertura frontale e scarico a parete serie EASY
 Ceramic WC H=49 cm with front opening and wall discharge EASY series
 Cuvette en céramique H=49cm avec ouverture frontale et évacuation murale série EASY
 Inodoro en cerámica H=49cm con apertura frontal y desagüe pared colección EASY

10210PLT

Lotto minimo 8 pz
 Minimum batch 8 pcs
 Minimum 8 pièces
 Lote mínimo 8 piezas

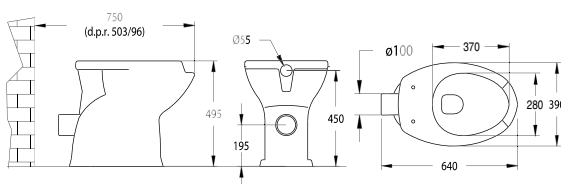
**11200 - P. 58****15409/4**

ART.	FINISHING	PACK.
10210	WHITE	1
10210PLT	WHITE	1
11200	WHITE	1
15409/4		1

**10205**Unified
Water Label

4,5 l

Vaso in ceramica H=49 cm, scarico a terra serie EASY

Ceramic WC H=49 cm with floor discharge EASY series

Cuvette en céramique H=49cm avec évacuation au sol série EASY

Inodoro en cerámica H=49cm con desagüe suelo colección EASY

10215

Vaso in ceramica H=49 cm, scarico a parete serie EASY

Ceramic WC H=49 cm with wall discharge EASY series

Cuvette en céramique H=49cm avec évacuation mural série EASY

Inodoro en cerámica H=49cm con desagüe a pared colección EASY

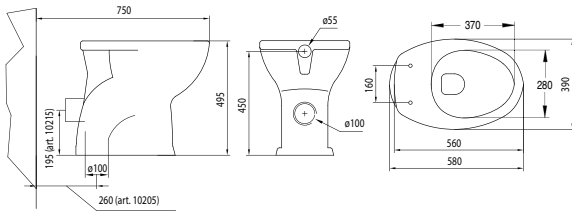
**11300 - P. 58****15409/4**

ART.	FINISHING	PACK.
10205	WHITE	1
10215	WHITE	1
11300	WHITE	1
15409/4		1

**10207**

Bidet in ceramica H=49 cm serie EASY

Ceramic bidet H=49 cm EASY series

Bidet en céramique H=49 cm série EASY

Bidet en cerámica H=49 cm colección EASY

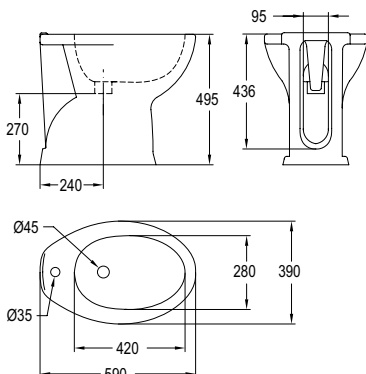
**15409/4**

ART.	FINISHING	PACK.
10207	WHITE	1
15409/4	WHITE	1

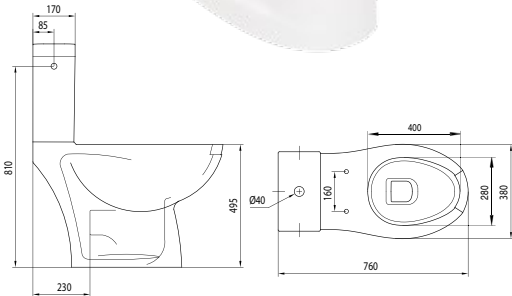
**10242**Unified Water Label **5 l**

Vaso monoblocco in ceramica H=49 cm, con apertura frontale serie EASY
 Ceramic monoblock WC H=49 cm with front opening EASY series
 Cuvette monobloc en céramique H=49cm, avec ouverture frontale série EASY
 Monobloque inodoro en cerámica H=49cm con apertura frontal colección EASY

15402/2

Cassetta di scarico in ceramica per vaso monoblocco (**ricambio**) serie EASY
 Ceramic cistern for monoblock WC (**spare part**) EASY series
 Réservoir en céramique pour cuvette monobloc (**pièce de rechange**) série EASY
 Cisterna de descarga en cerámica para inodoro monobloque (**repuesto**) colección EASY

**11200 - P. 58****15410****15409/4**

ART.	FINISHING	PACK.
10242	WHITE	1
15402/2	WHITE	1
11200	WHITE	1
15410		1
15409/4		1

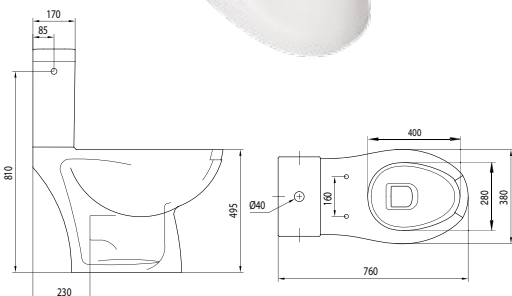
**10246**Unified Water Label **5 l**

Vaso monoblocco in ceramica H=49 cm serie EASY
 Ceramic monoblock WC H=49 cm EASY series
 Cuvette monobloc en céramique H=49cm série EASY
 Monobloque inodoro en cerámica H=49cm colección EASY

15402/2

Cassetta di scarico in ceramica per vaso monoblocco (**ricambio**) serie EASY
 Ceramic cistern for monoblock WC (**spare part**) EASY series
 Réservoir en céramique pour cuvette monobloc (**pièce de rechange**) série EASY
 Cisterna de descarga en cerámica para inodoro monobloque (**repuesto**) colección EASY

**11300 - P. 58****15410****15409/4**

ART.	FINISHING	PACK.
10246	WHITE	1
15402/2	WHITE	1
11300	WHITE	1
15410		1
15409/4		1

**10282**

Unified Water Label 5 l

Vaso monoblocco sospeso in ceramica cm 75, con apertura frontale serie EASY
 Ceramic wall hung monoblock WC cm 75, with front opening EASY series
 Cuvette monobloc suspendue en céramique 75 cm, avec ouverture frontale série EASY
 Inodoro monobloque suspendido en cerámica cm 75 con apertura frontal colección EASY

15402/2

Cassetta di scarico in ceramica per Vaso monoblocco (**ricambio**) serie EASY
 Ceramic cistern for monoblock WC (**spare part**) EASY series
 Réservoir en céramique pour cuvette monobloc (**pièce de rechange**) série EASY
 Cisterna de descarga en cerámica para inodoro monobloque (**repuesto**) colección EASY

**11200 - P. 58****15410****15107 - P. 62**

ART.

FINISHING

PACK.

10282
 15402/2
 11200
 15410
 15107

WHITE
 WHITE
 WHITE

1
 1
 1
 1

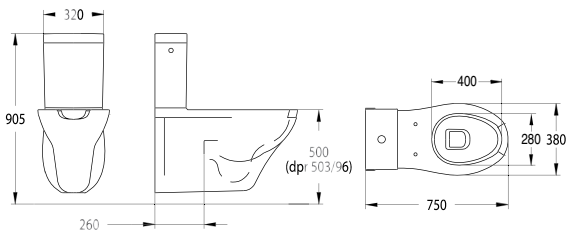
**10286**

Unified Water Label 5 l

Vaso monoblocco sospeso in ceramica cm 75 serie EASY
 Ceramic wall hung monoblock WC cm 75 EASY series
 Cuvette monobloc suspendue en céramique 75 cm série EASY
 Inodoro monobloque suspendido en cerámica cm 75 colección EASY

15402/2

Cassetta di scarico in ceramica per vaso monoblocco (**ricambio**) serie EASY
 Ceramic cistern for monoblock WC (**spare part**) EASY series
 Réservoir en céramique pour cuvette monobloc (**pièce de rechange**) série EASY
 Cisterna de descarga en cerámica para inodoro monobloque (**repuesto**) colección EASY

**11300 - P. 58****15410****15107 - P. 62**

ART.

FINISHING

PACK.

10286
 15402/2
 11300
 15410
 15107

WHITE
 WHITE
 WHITE

1
 1
 1
 1

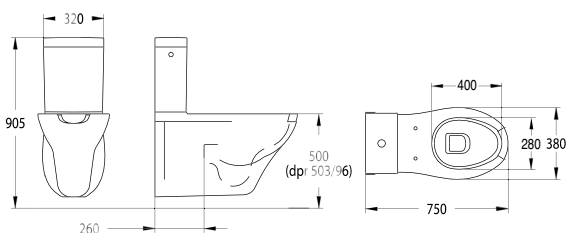

**10272**Unified
Water Label

4,5 l

Vaso sospeso in ceramica cm 75, con apertura frontale serie EASY

Ceramic wall hung WC cm 75 with front opening EASY series

Cuvette suspendue en céramique 75 cm, avec ouverture frontale série EASY

Inodoro suspendido en cerámica cm 75 con apertura frontal colección EASY



11200 - P. 58



15410



15107 - P. 62

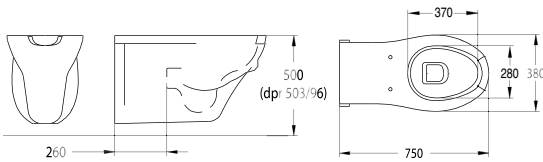

ART.

FINISHING

PACK.

10272

WHITE

1

11200

WHITE

1

15410

WHITE

1

15107

1

10276Unified
Water Label

4,5 l

Vaso sospeso in ceramica cm 75 serie EASY

Ceramic wall hung WC cm 75 EASY series

Cuvette suspendue en céramique 75 cm série EASY

Inodoro suspendido en cerámica cm 75 colección EASY



11300 - P. 58



15410



15107 - P. 62

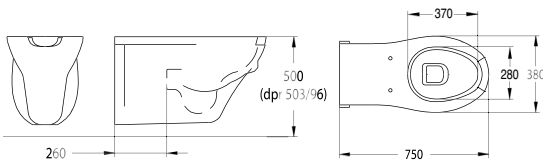

ART.

FINISHING

PACK.

10276

WHITE

1

11300

WHITE

1

15410

WHITE

1

15107

1



10262



Unified Water Label 4,5 l

Vaso sospeso in ceramica cm 54, con apertura frontale serie EASY

Ceramic wall hung WC cm 54 with front opening EASY series

Cuvette suspendue en céramique 54 cm, avec ouverture frontale série EASY

Inodoro suspendido en cerámica cm 54 con apertura frontal colección EASY



11200 - P. 58

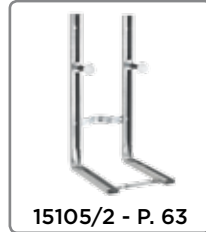

15105/2 - P. 63

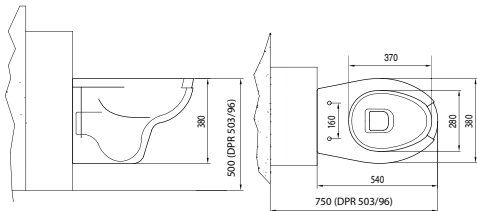

ART.	FINISHING	PACK.
10262	WHITE	1
11200	WHITE	1
15105/2		1



10266



Unified Water Label 4,5 l

Vaso sospeso in ceramica cm 54 serie EASY

Ceramic wall hung WC cm 54 EASY series

Cuvette suspendue en céramique 54 cm série EASY

Inodoro suspendido en cerámica cm 54 colección EASY



11300 - P. 58



15105/2 - P. 63

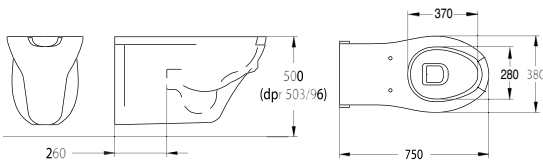

ART.	FINISHING	PACK.
10266	WHITE	1
11300	WHITE	1
15105/2		1



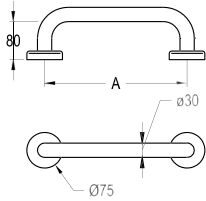

12000V



Maniglione lineare verniciato serie EASY
 Painted linear grab bar EASY series
 Barre d'appui linéaire peinte série EASY
 Barra de apoyo lineal pintada colección EASY

12000CV-ML

Corrimano verniciato a metro lineare
 Painted hand rail by linear meter
 Main courante peinte au mètre linéaire
 Pasamano al metro lineal pintado

FINISHING ON DEMAND

Rivestimento RILSAN su richiesta
 RILSAN coating on demand
 Finition RILSAN sur demande
 Acabado RILSAN a petición

- * Terzo punto di fissaggio in posizione centrale
- * Third fixing point in central position
- * Troisième point de fixation en position central
- * Tercer punto de fijación en posición central

ART.	A	FINISHING	PACK.
12000V-30	300 mm	WHITE	1
12000V-45	450 mm	WHITE	1
12000V-50	500 mm	WHITE	1
12000V-60	600 mm	WHITE	1
12000V-70	700 mm	WHITE	1
12000V-80	800 mm	WHITE	1
12000V-90	900 mm	WHITE	1
12000V-120	1200 mm	WHITE	1
12000V-150*	1500 mm	WHITE	1
12000V-180*	1800 mm	WHITE	1
12000V-200*	2000 mm	WHITE	1
12000CV-ML*		WHITE	1

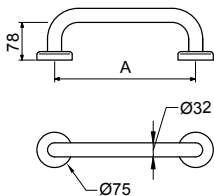

12000IS



Maniglione lineare in acciaio inox spazzolato serie EASY
 Brushed stainless steel linear grab bar EASY series
 Barre d'appui linéaire en acier inox brossé série EASY
 Barra de apoyo lineal en acero inox cepillado colección EASY

ART.	A	FINISHING	PACK.
12000IS-30	300 mm	INOX	1
12000IS-40	400 mm	INOX	1
12000IS-60	600 mm	INOX	1
12000IS-90	900 mm	INOX	1
12000IS-120	1200 mm	INOX	1



12013V



Maniglione angolare 135° verniciato serie EASY
 135° angled painted grab bar EASY series
 Barre d'appui angulaire 135° peinte série EASY
 Barra de apoyo angular de 135° pintada colección EASY

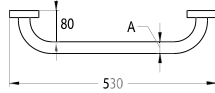
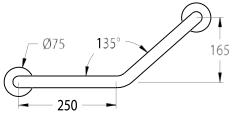

FINISHING ON DEMAND

Rivestimento RILSAN su richiesta
 RILSAN coating on demand
 Finition RILSAN sur demande
 Acabado RILSAN a petición

ART.	FINISHING	Ø	PACK.
12013V	WHITE	30	1



12013IS



Maniglione angolare 135° in acciaio inox spazzolato serie EASY
 Brushed stainless steel 135° angled grab bar EASY series
 Barre d'appui angulaire 135° en acier inox brossé série EASY
 Barra de apoyo angular de 135° en acero inox cepillado colección EASY

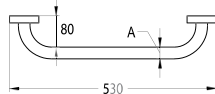
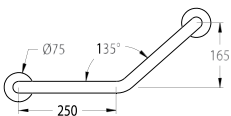

ART.	FINISHING	Ø	PACK.
12013IS	INOX	32	1



12003V-PP



Maniglione verticale verniciato, fissaggio parete/parete serie EASY
 Painted vertical grab bar wall/wall mounted EASY series
 Barre d'appui verticale peinte, fixation mur/mur série EASY
 Barra de apoyo vertical pared/pared, pintada colección EASY

12003V-PT

Maniglione verticale verniciato, fissaggio parete/terra serie EASY
 Painted vertical grab bar wall/floor mounted EASY series
 Barre d'appui verticale peinte, fixation mur/sol série EASY
 Barra de apoyo vertical pared/suelo, pintada colección EASY

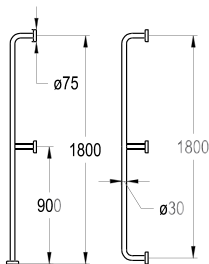

FINISHING ON DEMAND

Rivestimento RILSAN su richiesta
 RILSAN coating on demand
 Finition RILSAN sur demande
 Acabado RILSAN a petición

ART.

12003V-PP
 12003V-PT

FINISHING

WHITE
 WHITE

PACK.

1
 1



12001V



Maniglione montante verniciato, destro o sinistro serie EASY
 Painted 90° angled grab bar, left or right EASY series
 Barre d'appui coudée 90° peinte, gauche ou droite série EASY
 Barra de apoyo montante izquierda o derecha pintada colección EASY

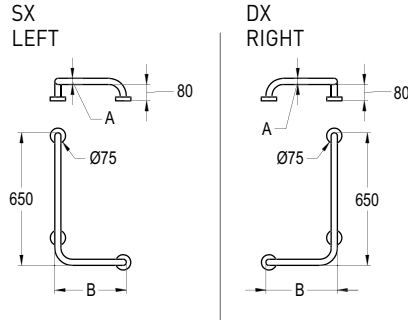

FINISHING ON DEMAND

Rivestimento RILSAN su richiesta
 RILSAN coating on demand
 Finition RILSAN sur demande
 Acabado RILSAN a petición

ART.	A	B	FINISHING	PACK.
12001V-DX	Ø30	350	WHITE	1
12001V-SX	Ø30	350	WHITE	1



12001IS



Maniglione montante in acciaio inox spazzolato, destro o sinistro serie EASY
 Brushed stainless steel 90° angled grab bar left or right EASY series
 Barre d'appui coudée 90° en acier inox brossé, gauche ou droite série EASY
 Barra de apoyo montante en acero inox cepillado izquierda o derecha colección EASY

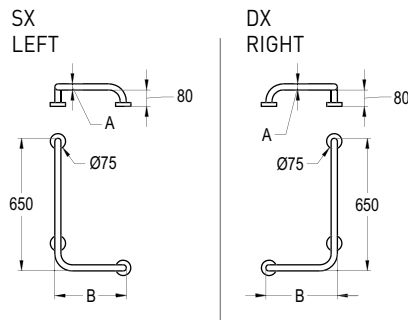

ART.	A	B	FINISHING	PACK.
12001IS-DX	Ø32	300	INOX	1
12001IS-SX	Ø32	300	INOX	1



12002V



Maniglione angolare verniciato serie EASY
 Angled painted grab bar EASY series
 Barre d'appui angulaire peinte série EASY
 Barra de apoyo angular pintada colección EASY

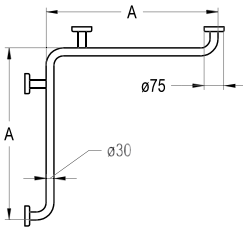

FINISHING ON DEMAND

Rivestimento RILSAN su richiesta
 RILSAN coating on demand
 Finition RILSAN sur demande
 Acabado RILSAN a petición

ART.	A	FINISHING	PACK.
120002V-65	650x650	WHITE	1
120002V-75	750x750	WHITE	1
120002V-100	1000x1000	WHITE	1

12004V



Barra di sostegno verniciata, destra o sinistra serie EASY
 Left or right painted grab bar EASY series
 Barre d'appui peinte, gauche ou droite série EASY
 Barra de apoyo izquierda o derecha pintada colección EASY

12004V-SX

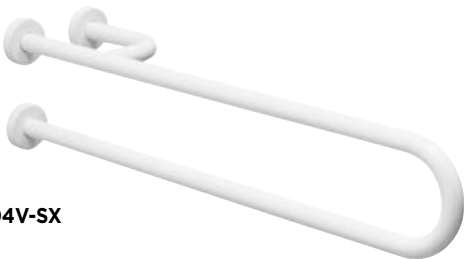

SX
LEFT

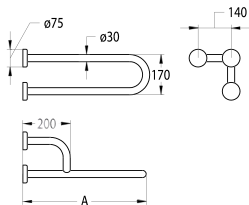

DX
RIGHT

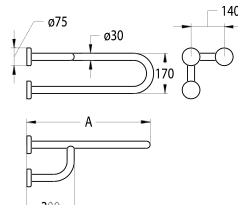

FINISHING ON DEMAND

Rivestimento RILSAN su richiesta
 RILSAN coating on demand
 Finition RILSAN sur demande
 Acabado RILSAN a petición

ART.	A	FINISHING	PACK.
12004V-65DX	650	WHITE	1
12004V-65SX	650	WHITE	1
12004V-85DX	850	WHITE	1
12004V-85SX	850	WHITE	1



12005V



Barra di sostegno ribaltabile verniciata serie EASY

Folding painted grab bar EASY series

Barre d'appui relevable peinte série EASY

Barra de apoyo abatible pintada colección EASY

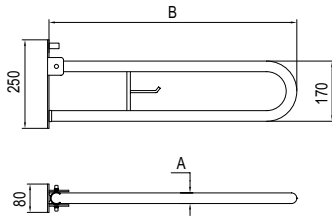

FINISHING ON DEMAND

Rivestimento RILSAN su richiesta
RILSAN coating on demand
 Finition RILSAN sur demande
 Acabado RILSAN a petición

ART.	A	B	FINISHING	PACK.
12005V-70	Ø30	700	WHITE	1
12005V-80	Ø30	800	WHITE	1

12005IS-80

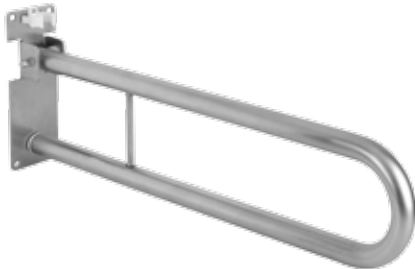

Barra di sostegno ribaltabile in acciaio inox spazzolato serie EASY

Folding grab bar in brushed stainless steel EASY series

Barre d'appui relevable en acier inox brossé série EASY

Barra de apoyo abatible en acero inox cepillado colección EASY

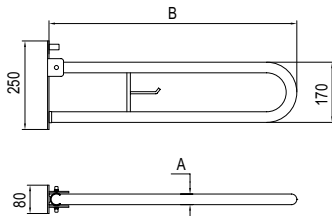

ART.	A	B	FINISHING	PACK.
12005IS-80	Ø32	800	INOX	1

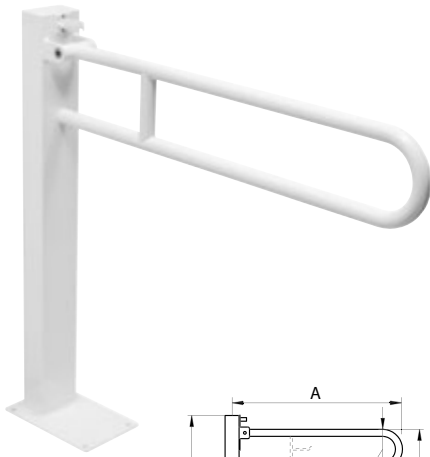

12006V



Barra di sostegno ribaltabile su colonna verniciata serie EASY
 Folding painted grab bar on post EASY series
 Barre d'appui relevable sur poteau peinte série EASY
 Barra de apoyo abatible con columna, pintada, colección EASY

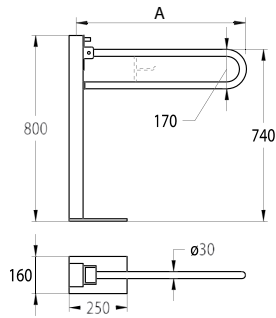

FINISHING ON DEMAND

Rivestimento RILSAN su richiesta
 RILSAN coating on demand
 Finition RILSAN sur demande
 Acabado RILSAN a petición

ART.	A	FINISHING	PACK.
12006V-70	700	WHITE	1
12006V-80	800	WHITE	1



**12007.1**

Sedile doccia ribaltabile per fissaggio a parete serie EASY

Wall mounted folding shower seat EASY series

Siège de douche mural rabattable série EASY

Asiento ducha de pared abatible colección EASY

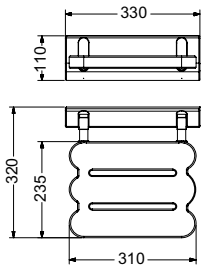

ART.	FINISHING	PACK.
12007.1	WHITE	1

**12007.2**

Sedile doccia ribaltabile per fissaggio a parete, con gambe di appoggio serie EASY

Wall mounted folding shower seat with legs EASY series

Siège de douche mural rabattable avec pieds série EASY

Asiento ducha de pared abatible con apoyo al suelo colección EASY

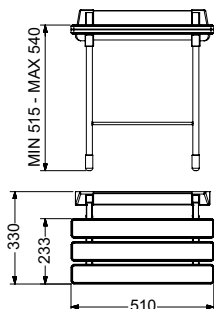

ART.	FINISHING	PACK.
12007.2	WHITE	1

**12008V**

Sedile ribaltabile per doccia con schienale, fissaggio a parete, verniciato serie EASY

Wall mounted folding shower seat with backrest painted EASY series

Siège de douche mural rabattable avec dossier, peint série EASY

Asiento ducha de pared abatible con respaldo pintado colección EASY

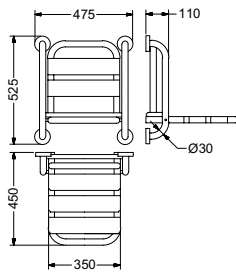

ART.	FINISHING	PACK.
12008V	WHITE	1

**12008/1V**

Sedile ribaltabile per doccia con schienale e braccioli; fissaggio a parete, verniciato serie EASY

Wall-mounted folding shower seat with backrest and armrests, painted EASY series

Siège de douche mural rabattable avec dossier et bras, peint série EASY

Asiento ducha de pared abatible con respaldo y brazos, pintado colección EASY

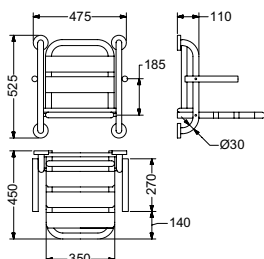

ART.	FINISHING	PACK.
12008/1V	WHITE	1

**12008/2V**

Sedile ribaltabile per doccia senza schienale, fissaggio a parete, verniciato serie EASY
 Wall mounted folding shower seat without backrest, painted EASY series
 Siège de douche mural rabattable sans dossier, peint série EASY
 Asiento ducha de pared abatible sin respaldo, pintado colección EASY

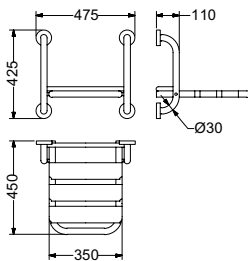

ART.	FINISHING	PACK.
12008/2V	WHITE	1

**12008IS**

Sedile ribaltabile per doccia senza schienale fissaggio a parete, in acciaio inox spazzolato serie EASY
 Wall mounted folding shower seat without backrest, in brushed stainless steel EASY series
 Siège de douche mural rabattable, sans dossier, en acier inox brossé série EASY
 Asiento ducha de pared abatible sin respaldo, en acero inox cepillado colección EASY

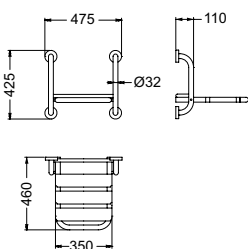

ART.	FINISHING	PACK.
12008IS	INOX	1

**12010V**

Specchio reclinabile verniciato serie EASY
 Painted adjustable mirror EASY series
 Miroir orientable peint série EASY
 Espejo reclinable pintado colección EASY

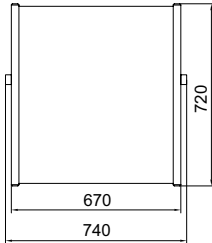

ART.	FINISHING	PACK.
12010V	WHITE	1

**12010/1V**

Specchio reclinabile con cornice serie EASY
 Adjustable mirror with frame EASY series
 Miroir orientable avec cadre série EASY
 Espejo reclinable con marco colección EASY

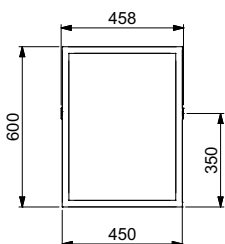

ART.	FINISHING	PACK.
12010/1V	WHITE	1

**12010IS**

Specchio reclinabile in acciaio inox serie EASY
 Stainless steel adjustable mirror EASY series
 Miroir orientable en acier inox série EASY
 Espejo reclinable en acero inox colección EASY

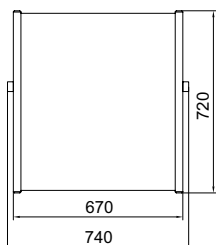

ART.	FINISHING	PACK.
12010IS	INOX	1

**12010/I**

Specchio fisso in acciaio inox serie EASY
 Fixed mirror stainless steel EASY series
 Miroir fixe en acier inox série EASY
 Espejo fijo en acero inox colección EASY

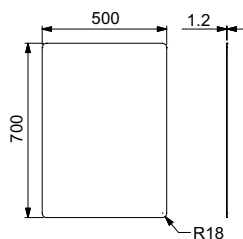

ART.	FINISHING	PACK.
12010/I	MIRROR	1

**15501.2**

Seduta per vasca senza schienale serie EASY
 Seat for bath tube without backrest EASY series
 Siège de baignoire sans dossier série EASY
 Asiento para bañera sin respaldo colección EASY



ART.	FINISHING	PACK.
15501.2	WHITE	1

15506.1

Rialzo per wc universale H=10 cm con coperchio
 Raised toilet seat H=10 cm with lid
 Rehausse pour cuvette universelle H=10 cm avec couvercle
 Asiento elevador para inodoro universal h=10 cm con tapa



ART.	FINISHING	PACK.
15506.1	WHITE	1

**15504.1**

Sgabello tondo serie EASY
Round stool EASY series
Tabouret rond série EASY
Taburete redondo colección EASY

ART.	FINISHING	PACK.
15504.1	WHITE	1

**15507.1**

Sgabello rettangolare serie EASY
Square stool EASY series
Tabouret rectangulaire série EASY
Taburete rectangular colección EASY

ART.	FINISHING	PACK.
15507.1	WHITE	1

**12014**

Doccetta con flessibile e supporto scorrevole cromato per maniglioni Ø30/32
 Hand shower with flexible hose and chrome sliding support for grab bars Ø30/32
 Douchette avec flexible et support coulissant chromé pour barres d'appui Ø30/32
 Teleducha y flexible con soporte deslizante cromado para barras de apoyo Ø30/32

12014S

Supporto scorrevole cromo per doccetta. Per maniglioni Ø30/32
 Chrome sliding support for hand shower For grab bars Ø30/32
 Support coulissant chromé pour douchette. Pour barres d'appui Ø30/32
 Soporte deslizante cromado para teleducha. Para barras de apoyo Ø30/32



12000V P. 42



12000IS P. 42

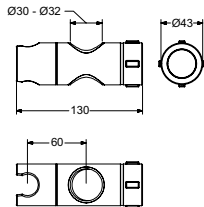

ART.	FINISHING	PACK.
12014	CHROME	1
12014S	CHROME	1



**15200**

Piatto doccia a filo pavimento. In vetroresina, senza piletta, 80x80 cm serie EASY

Floor level shower tray In fiberglass, without drain, 80x80 cm EASY series

Receveur de douche extra-plat sans seuil. En fibre de verre, sans bonde de vidage, 80x80 cm série EASY

*Plato de ducha enrasado en fibra de vidrio, sin válvula de desagüe, 80x80 cm colección EASY***15201**

Piatto doccia a filo pavimento. In vetroresina, senza piletta, 90x90 cm serie EASY

Floor level shower tray In fiberglass, without drain, 90x90 cm EASY series

Receveur de douche extra-plat sans seuil. En fibre de verre, sans bonde de vidage, 90x90 cm série EASY

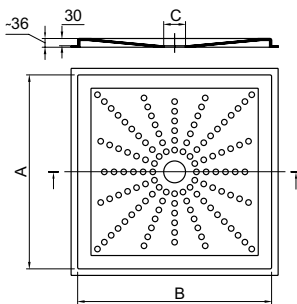
Plato de ducha enrasado en fibra de vidrio, sin válvula de desagüe, 90x90 cm colección EASY

ART.	AxB	C	FINISHING	PACK.
15200	80x80	Ø90	WHITE	1
15201	90x90	Ø90	WHITE	

**15600**

Piletta sifonata per piatto doccia in vetroresina Ø90 mm

Drain with siphon for fiberglass shower tray Ø90 mm

Bonde de vidage avec siphon pour receveur douche en fibre de verre Ø90mm

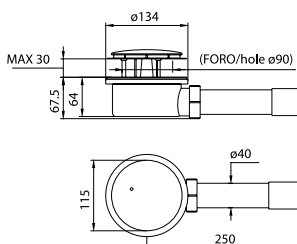
Válvula de desagüe con sifón para plato ducha en fibra de vidrio Ø90 mm

ART.	FINISHING	PACK.
15600	CHROME	1

**11200**

Sedile bianco per vasi con apertura frontale serie EASY
 White cover seat for WC with front opening EASY series
 Abattant blanc pour cuvette avec ouverture frontale série EASY
 Asiento blanco para inodoros con apertura frontal colección EASY

ART.	FINISHING	PACK.
11200	WHITE	1

**11200/E**

Sedile termoformato bianco per vasi con apertura frontale serie EASY
 White thermoformed cover seat for WC with front opening EASY series
 Abattant WC thermoformé blanc pour cuvettes avec ouverture frontale série EASY
 Asiento termomoldeado para inodoros con apertura frontal colección EASY

ART.	FINISHING	PACK.
11200/E	WHITE	1

**11200/C**

Copertura igienica per vasi con apertura frontale serie EASY
 Toilet seat for WC with front opening EASY series
 Siège amovible pour cuvettes avec ouverture frontale série EASY
 Asiento amovible para inodoros con apertura frontal colección EASY

ART.	FINISHING	PACK.
11200/C	WHITE	1

**11300**

Sedile bianco per vasi senza apertura frontale serie EASY
 White cover seat for WC without front opening EASY series
 Abattant blanc pour cuvette sans ouverture frontale série EASY
 Asiento blanco para inodoros sin apertura frontal colección EASY

ART.	FINISHING	PACK.
11300	WHITE	1



**15404**

Comando pneumatico a pulsante per cassetta wc in plastica bianca per montaggio esterno a parete, con kit di collegamento

White plastic pneumatic push button control for WC cistern for external wall mounting with connection kit

Commande pneumatique à poussoir pour réservoir de cuvette en plastique blanc pour montage mural externe, avec kit de raccordement

Mando neumático de pulsador para cisterna de inodoro de plástico blanco para montaje externo en pared, con kit de conexión

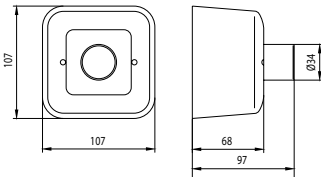

ART.

PACK.

15404

1

**15405**

Comando pneumatico a pulsante per cassetta wc in plastica bianca per montaggio ad incasso, con kit di collegamento da incasso

White plastic pneumatic push button control for WC cistern for concealed mounting with concealed connection kit

Commande pneumatique à poussoir pour réservoir de cuvette en plastique blanc pour montage encastré, avec kit de raccordement à encastrer

Mando neumático de pulsador para cisterna de inodoro de plástico blanco para montaje empotrado, con kit de conexión para empotrado

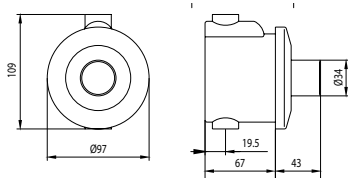

ART.

PACK.

15405

1

**15407**

Kit di scarico per lavabo con piletta, sifone da incasso e tubo corrugato in plastica 1"1/4

Drain kit for basin with drain, concealed siphon and corrugated plastic pipe 1"1/4

Kit de vidange avec bonde pour lavabo, siphon encastré et tube cannelé en plastique 1"1/4

Kit desagüe con válvula para lavabo, sifón empotrado y tubo corrugado en plástico 1"1/4

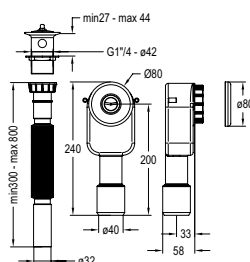

ART.

PACK.

15407

1

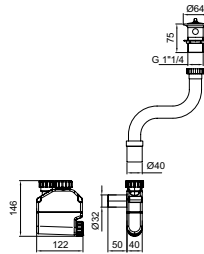
**15408**

Kit di scarico per lavabo con piletta, sifone esterno e tubo corrugato in plastica 1"1/4
 Drain kit for basin with drain, external siphon and corrugated plastic pipe 1"1/4
 Kit de vidange avec bonde pour lavabo, siphon externe et tube cannelé en plastique 1"1/4
 Kit desagüe con válvula para lavabo, tubo corrugado en plástico 1"1/4 sifón externo

ART.

15408

PACK.

1

**15411**

Curva di scarico a "S" per vaso Ø110 mm
 "S" drain elbow for WC Ø110 mm
 Coude de vidage en "S" pour cuvette Ø110 mm
 Curva de desagüe a "S" para inodoro Ø110 mm

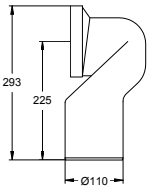

ART.

15411

PACK.

1

**15412**

Tubo di scarico diretto per vaso Ø110x400 mm
 Straight drain pipe for WC Ø110x400 mm
 Tuyau de vidage droit pour cuvette Ø110x400 mm
 Tubo de desagüe derecho Ø110x400 mm para inodoro

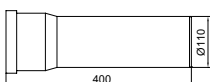

ART.

15412

PACK.

1

**15107**

Struttura di sostegno per vaso sospeso per muratura, 4 punti di fissaggio per vasi 10272-76-82-86 serie EASY

Support for masonry, for wall hung WC, 4 fastening points for WC 10272-76-82-86 EASY series

Structure pour cuvettes suspendues pour maçonnerie, avec 4 points de fixation pour art. 10272-76-82-86 série EASY

Estructura de soporte para inodoros suspendidos para fijación en paredes de mampostería, con 4 puntos de fijación para art. 10272-76-82-86 colección EASY

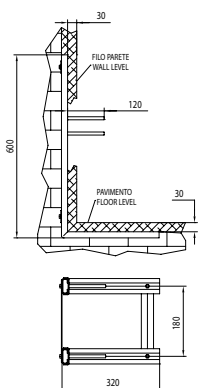

ART.

PACK.

15107

1

**15107-CG**

Struttura di sostegno per vaso sospeso per cartongesso, 4 punti di fissaggio per vasi 10272-76-82-86 serie EASY

Support for plasterboard, for wall hung WC, 4 fastening points for WC 10272-76-82-86 EASY series

Structure pour cuvettes suspendues pour murs en placoplâtre, avec 4 points de fixation pour art. 10272-76-82-86 série EASY

Estructura de soporte para inodoros suspendidos con 4 puntos de fijación, para fijación en paredes de cartón piedra para art. 10272-76-82-86 colección EASY

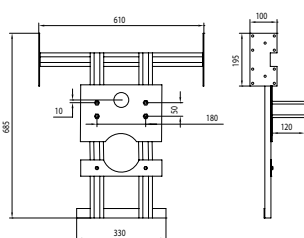

ART.

PACK.

15107-CG

1

**15105/2**

Struttura di sostegno per vaso sospeso per muratura, 2 punti di fissaggio per vasi 10262-66 serie EASY

Support for masonry, for wall hung WC, 2 fastening points for WC 10262-66 EASY series

Structure pour cuvettes suspendues pour maçonnerie, avec 2 points de fixation pour art. 10262-66 série EASY

Estructura de soporte para inodoros suspendidos para fijación en paredes de mampostería, con 2 puntos de fijación para art. 10262-66 colección EASY

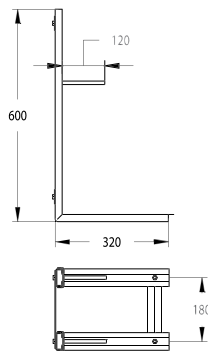

ART.

PACK.

15105/2

1

**15105/2CG**

Struttura di sostegno per vaso sospeso per cartongesso, 2 punti di fissaggio per vasi 10262-66 serie EASY

Support for plasterboard, for wall hung WC, 2 fastening point for WC 10262-66 EASY series

Structure pour cuvettes suspendues pour murs en placoplâtre, avec 2 points de fixation pour art. 10262-66 série EASY

Estructura de soporte para inodoros suspendidos con 2 puntos de fijación, para fijación en paredes de cartón piedra para art. 10262-66 colección EASY

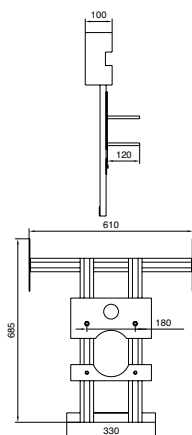

ART.

PACK.

15105/2CG

1

**15100**

Coppia mensole fisse per lavabo serie EASY
 Fixed shelves pair for basin EASY series
 Paire de supports fixes pour lavabo série EASY
 Pareja de repisas fijas para lavabo colección EASY

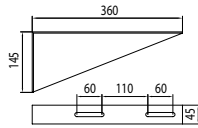

ART.

PACK.

15100

1

**15101**

Mensola reclinabile per lavabo. Regolazione a manopola, serie EASY
 Tilting shelf for basin Knob adjustment, EASY series
 Support de lavabo inclinable. Réglage à bouton, série EASY
 Repisa abatible para lavabo. Regulación con pomo, colección EASY

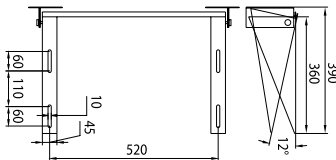

ART.

PACK.

15101

1

**15102**

Mensola reclinabile per lavabo. Regolazione pneumatica con leva frontale, serie EASY
 Tilting shelf for basin Pneumatic adjustment with front lever, EASY series
 Support de lavabo inclinable. Réglage pneumatique avec levier frontal, série EASY
 Repisa neumática abatible para lavabo. Regulación neumática con palanca frontal, colección EASY

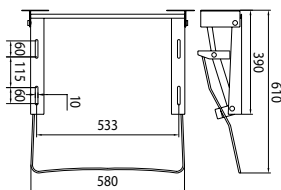

ART.

PACK.

15102

1

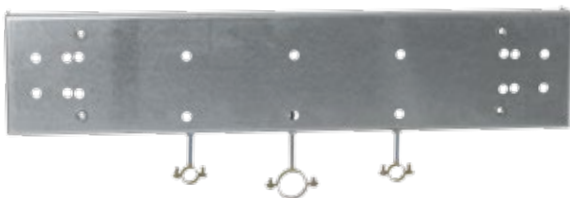
**15106-CG**

Struttura per mensole, per fissaggio su cartongesso, serie EASY
 Shelf plasterboard mounting support, EASY series
 Structure pour supports, pour fixation sur murs en placoplâtre, série EASY
 Estructura metálica para fijación de repisas en paredes de cartón piedra, colección EASY

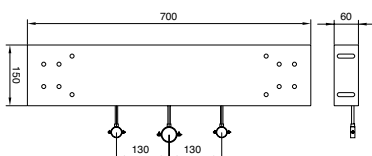

ART.

PACK.

15106-CG

1



**900.16**

Miscelatore termostatico ad incasso progressivo con leva clinica e doccetta igienica serie 900

Thermostatic progressive concealed mixer, clinical lever operated, with shower hand for personal hygiene 900 series

Mitigeur thermostatique progressif encastré avec manette clinique et douchette pour cuvette série 900

Mezclador termostático progresivo empotrado con palanca medical y ducha higiénica colección 900

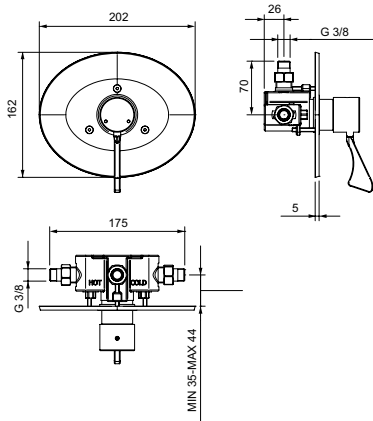

ART.	FINISHING	PACK.
900.16	CHROME	1

**900.24**

Miscelatore termostatico progressivo a leva clinica con doccetta igienica serie 900

Thermostatic progressive mixer, clinical lever operated, with shower hand for personal hygiene 900 series

Mitigeur thermostatique progressif à manette clinique avec douchette hygiénique série 900

Mezclador termostático progresivo con palanca medical y ducha higiénica colección 900

900.37

Versione senza doccetta igienica

Version without shower hand for personal hygiene

Version sans douchette hygiénique

Versión sin ducha higiénica

900.24/M

Versione con comando a maniglia

Handle operated version

Version à poignée

Versión con pomo

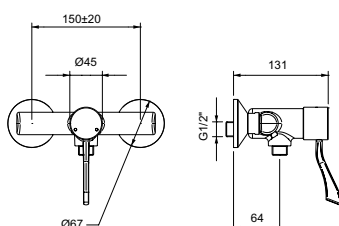

ART.	FINISHING	PACK.
900.24	CHROME	1
900.37	CHROME	1
900.24/M	CHROME	1

**02404**

Miscelatore a leva clinica con doccetta igienica, serie EASY
 Clinical lever operated mixer with shower hand for personal hygiene, EASY series
 Mitigeur à manette clinique avec douchette hygiénique, série EASY
 Mezclador con palanca medical y ducha higiénica, colección EASY

02404/LN

Versione con comando a leva corta
 Short lever operated version
 Version à manette courte
 Versión con palanca corta

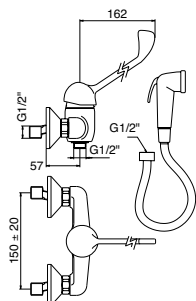

ART.	FINISHING	PACK.
02404	CHROME	1
02404/LN	CHROME	1

**02405/LN**

Miscelatore a leva corta con doccetta igienica, serie EASY
 Short lever operated mixer with shower hand for personal hygiene, EASY series
 Mitigeur à manette courte avec douchette hygiénique, série EASY
 Mezclador con palanca corta y ducha higiénica, colección EASY

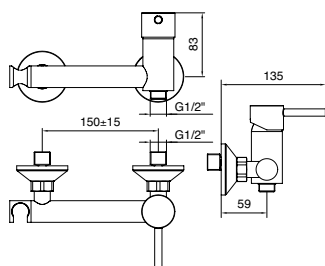

ART.	FINISHING	PACK.
02405/LN	CHROME	1

**02427/S**

Rubinetto temporizzato con supporto per doccia igienica
 Self-closing push tap with support for hand shower
 Robinet temporisé avec support pour douche hygiénique
 Grifo temporizado con soporte para ducha higiénica

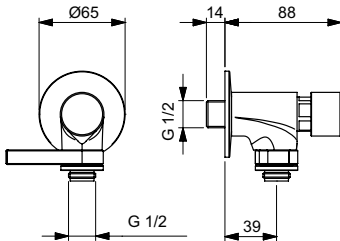
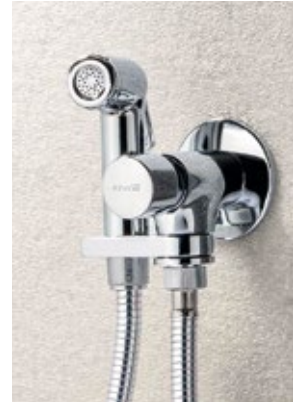
**02419/C****09024/DC****09024/D**

ART.
02427/S

FINISHING
CHROME

PACK.
1

**02419/C****WC**

Iperscopino in plastica cromata con supporto murale, serie EASY
 Chromed plastic hydrobrush with wall support, EASY series
 Hydro-brosse en plastique chromé avec support mural, série EASY
 Hidroescobilla en plástico cromado con soporte mural, colección EASY

02419/CDOC

Iperscopino in plastica cromata
 Chromed plastic hydrobrush
 Hydro-brosse en plastique chromé
 Hidroescobilla en plástico cromado

02419/CFLEX

Flessibile in PVC cromato
 Chromed PVC flexible hose
 Flexible en PVC chromé
 Flexible en PVC cromado

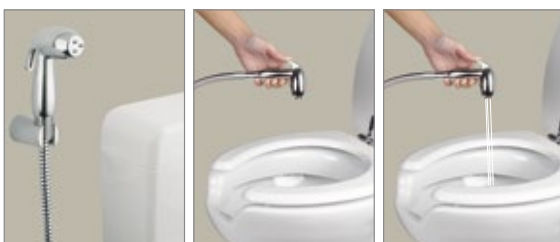

ART.

FINISHING

PACK.

02419/C

CHROME

1

02419/CDOC

CHROME

1

02419/CFLEX

CHROME

1

**09024/DC**

Doccetta igienica in plastica cromata con supporto murale, serie EASY
 Chromed plastic shower hand for personal hygiene with wall support, EASY series
 Douchette hygiénique en plastique chromé avec support mural, série EASY
 Ducha higiénica en plástico cromado con soporte mural, colección EASY

02405DOC

Doccetta igienica in plastica cromata
 Chromed plastic shower hand for personal hygiene
 Douchette hygiénique en plastique chromé
 Ducha higiénica en plástico cromado

02405FLEX

Flessibile in PVC cromato
 Chromed PVC flexible hose
 Flexible en PVC chromé
 Flexible en PVC cromado

ART.	FINISHING	PACK.
09024/DC	CHROME	1
02405DOC	CHROME	1
02405FLEX	CHROME	1

**09024/D**

Doccetta igienica in plastica bianca con supporto murale, serie EASY
 White plastic shower hand for personal hygiene with wall support, EASY series
 Douchette hygiénique en plastique blanc avec support mural, série EASY
 Ducha higiénica en plástico blanco con soporte mural, colección EASY

09024/DV

Versione senza limitatore di portata
 Version without flow limiter
 Version sans limiteur de débit
 Versión sin limitador de caudal

09024DOC

Doccetta igienica in plastica bianca
 White plastic shower hand for personal hygiene
 Douchette hygiénique en plastique blanc
 Ducha higiénica en plástico blanco

09024FLEX

Flessibile in PVC bianco
 White PVC flexible hose
 Flexible en PVC blanc
 Flexible en PVC blanco

ART.	FINISHING	PACK.
09024/D	WHITE	1
09024/DV	WHITE	1
09024DOC	WHITE	1
09024FLEX	WHITE	1



H₂O



ecologia
sustainability
ecologie
ecología



sicurezza e prevenzione
safety and prevention
sécurité et prévention
seguridad y prevención



risparmio acqua
water saving
economie d'eau
ahorro de agua



qualità
quality
qualité
calidad



attenzione ambiente
environment care
attention à l'environnement
atención al medio ambiente



specializzazione
specialization
spécialisation
especialización



risparmio energia
energy saving
economie d'énergie
ahorro de energía



servizio al cliente
customer service
service au client
servicio al cliente



igiene
hygiene
hygiène
higiene



sicurezza antivandalo
vandal proof safety
protection anti-vandalisme
protección antivándalica



prevenzione batteri
bacteria prevention
prévention des bactéries
prevención de bacterias



resistenza
resistance
résistance
resistencia



facile pulizia
easy cleaning
nettoyage facile
fácil limpieza



materiali speciali
special material
matériaux spéciaux
materiales especiales



praticità
comfort
practicité
practicidad



design
design
design
diseño



innovazione
innovation
innovation
innovación



gamma completa
complete range
gamme complète
gama completa

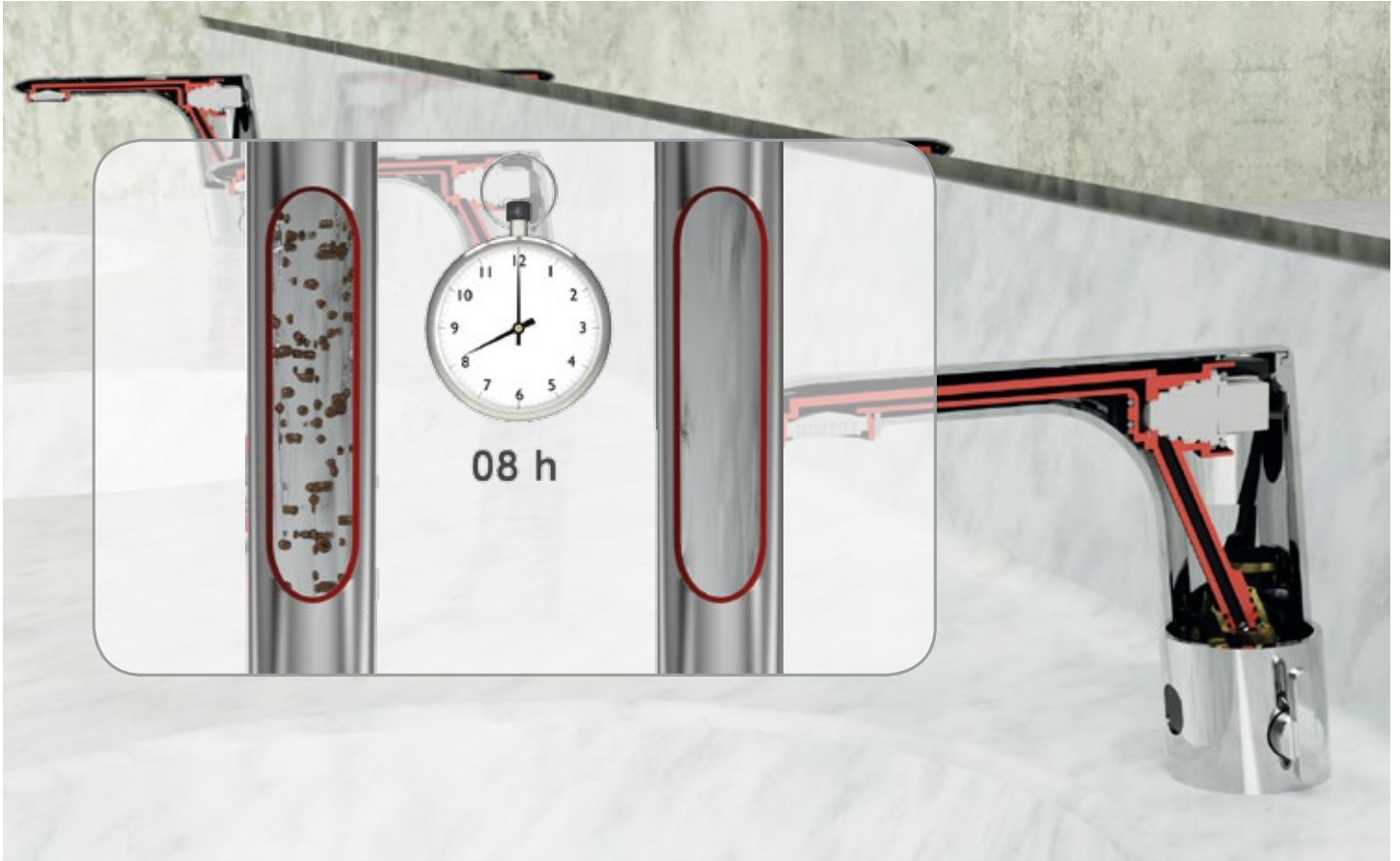

Risciacquo automatico ogni 24 ore / Automatic rinse every 24 hours
 Rinçage automatique chaque 24 heures / Lavado automático cada 24 horas

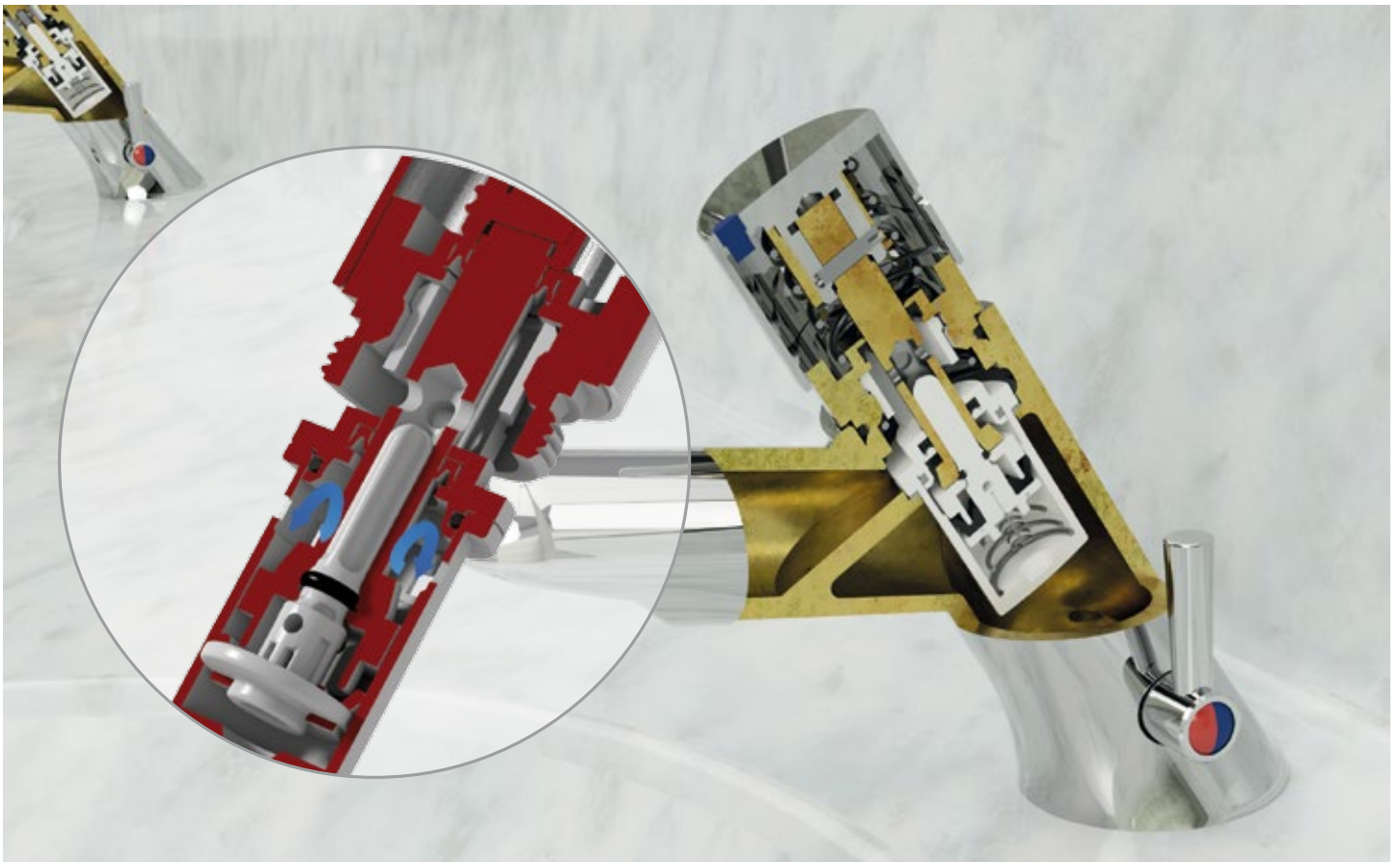

La chiusura è garantita anche in caso di blocco volontario del pulsante / Guaranteed flow stop in case of voluntary push button locking
 La fermeture est garanti même en cas de bloque volontaire du pousseir / El cierre está garantizado también en caso de bloqueo voluntario del pulsador

4all

LAVABO MULTIFUNZIONE A PARETE
MULTIFUNCTIONAL WALL MOUNTED BASIN

È la nuova soluzione che lava, insapona, sciacqua e asciuga le mani, tutto in uno, con un disegno compatto. È un lavabo multifunzione a parete realizzato in Solid Surface, completo di erogatore acqua, dispenser sapone e asciugamani ad aria. Tutti i suoi dispositivi sono elettronici e temporizzati a favore di un risparmio d'acqua, di energia e di una maggiore e più facile pulizia. Il funzionamento con il semplice passaggio delle mani lo rende accessibile a tutti, pratico anche per le persone in condizione di mobilità ridotta. Può essere utilizzato come singolo elemento o come modulo affiancato per allestire grandi spazi.

It is the new solution that washes, rinses and dries your hands, all in one, with a compact design. Multi-functional wall mounted basin made of Solid Surface equipped with water dispenser, soap dispenser and hand dryer. All its devices are electronic and time-controlled to guarantee water and energy saving and easier cleaning. The activation with the simple passage of the hands makes it accessible to everyone, practical also for the people with reduced mobility. It can be used as a single element, or a side-by-side module to set up larger spaces.



Le lavabo multifonctionnel mural en résine blanche (Solid Surface) est fourni de distributeur d'eau, de savon et sèche-mains. Tous ses appareils sont électriques et temporisés en faveur d'économies d'eau, d'énergie et d'un nettoyage plus grand et plus facile. Le fonctionnement effectué avec le passage simple des mains le rend accessible à tout le monde, aussi pratique pour les personnes avec mobilité réduite. Il peut être utilisé en tant qu'élément unique ou en tant que module côte à côte pour configurer des grands espaces.

El lavabo multifunción a pared en resina blanca (Solid Surface) es equipado con dispensador de agua, de jabón y secador de aire. Todos los dispositivos son electrónicos y temporizados a favor de un ahorro de agua, de energía y una mayor y más fácil limpieza. Su funcionamiento a través del simple pasaje de las manos lo hace accesible a todos, práctico también para personas con movilidad reducida. Se puede utilizar como elemento único o como un módulo de lado a lado para configurar espacios grandes.



SENSORE ELETTRONICO
ELECTRONIC SENSOR
SENSORE ELETTRONICO
ELECTRONIC SENSOR



EROGATORE SAPONE
SOAP DISPENSER
DISTRIBUTEUR DE SAVON
DISPENSADORE DE JABÓN



EROGATORE ACQUA
WATER DISPENSER
DISTRIBUTEUR D'EAU
DISPENSADOR DE AGUA



ASCIUGAMANI AD ARIA
HAND DRYER
SÈCHE-MAINS
SECAMANOS

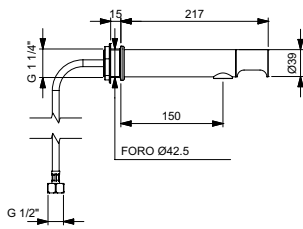

**SU RICHIESTA / ON DEMAND / SUR DEMAND / A PETICIÓN**

- D1** Nero - Black - Noir - Negro
E1 Bianco - White - Blanche - Blanco
O3 Oro - Gold - Or - Oro
2F Nickel - Nickel - Nickel - Níquel
N3 Rame - Copper - Cuivre - Cobre
R1 Grafite - Graphite - Graphite - Grafito

551.10

Rubinetto elettronico per lavabo a parete, alimentazione a rete 230V, serie 4ALL

Electronic wall-mounted basin tap, powered by mains 230V, 4ALL series

Robinet électronique mural, alimentation sur secteur 230V, série 4ALL

Grifo electrónico para lavabo de pared, alimentación de red 230V, colección 4ALL

1,9 l/min



KTO1LD - P. 271

ART.	FINISHING	PACK.
551.10	CHROME	1
551	CHROME	1

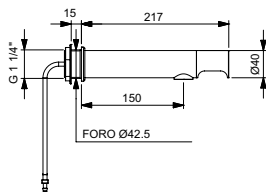
**SU RICHIESTA / ON DEMAND / SUR DEMAND / A PETICIÓN**

- D1** Nero - Black - Noir - Negro
E1 Bianco - White - Blanche - Blanco
O3 Oro - Gold - Or - Oro
2F Nickel - Nickel - Nickel - Níquel
N3 Rame - Copper - Cuivre - Cobre
R1 Grafite - Graphite - Graphite - Grafito

551.20

Dispenser sapone elettronico a parete, alimentazione a rete 230V, serie 4ALL

Electronic wall mounted soap dispenser, powered by mains 230V, 4ALL series

Distributeur électronique de savon mural, alimentation sur secteur 230V, série 4all

Dispensador de jabón electrónico de pared, alimentación de red 230V, colección 4ALL

ART.	FINISHING	PACK.
551.20	CHROME	1
551	CHROME	1

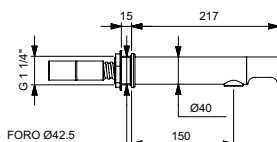
**SU RICHIESTA / ON DEMAND / SUR DEMAND / A PETICIÓN**

- D1** Nero - Black - Noir - Negro
E1 Bianco - White - Blanche - Blanco
O3 Oro - Gold - Or - Oro
2F Nickel - Nickel - Nickel - Níquel
N3 Rame - Copper - Cuivre - Cobre
R1 Grafite - Graphite - Graphite - Grafito

551.30

Asciugamani elettronico a parete, alimentazione 230V, serie 4ALL

Electronic wall-mounted hand dryer, powered by mains 230V, 4ALL series

Sèche-mains électronique mural, alimentation sur secteur 230V, série 4ALL

Secamanos electrónico de pared, alimentación de red 230V, colección 4ALL

1,9 l/min



KTO1LD - P. 271

ART.	FINISHING	PACK.
551.30	CHROME	1
551	CHROME	1

**551**

Kit per lavabo completo di erogatore acqua, dispenser sapone e asciugamani ad aria; a comando elettronico e alimentazione a rete 230V. Serie 4ALL

Basin complete kit equipped with electronic water and soap dispenser and hand dryer, powered by mains 230V. 4ALL series

Ensemble à commande électronique pour lavabo équipé de distributeur d'eau et de savon et sèche-mains, alimentation sur secteur 230V. Série 4ALL

Conjunto con mando electrónico para lavabo multi-funcional equipado con dispensador de agua y de jabón y secamános. Alimentación de red 230V. Colección 4ALL

SU RICHIESTA / ON DEMAND / SUR DEMAND / A PETICIÓN

D1 Nero - Black - Noir - Negro
E1 Bianco - White - Blanche - Blanco
O3 Oro - Gold - Or - Oro
2F Nickel - Nickel - Nickel - Níquel
N3 Rame - Copper - Cuivre - Cobre
R1 Grafite - Graphite - Graphite - Grafito

ART.

FINISHING

PACK.

551

CHROME

1



**560.10**

Rubinetto elettronico per lavabo a parete, alimentazione a rete 230V, serie 4ALL

Electronic wall-mounted basin tap, powered by mains 230V, 4ALL series

Robinet électronique mural, alimentation sur secteur 230V, série 4ALL

Grifo electrónico para lavabo de pared, alimentación de red 230V, colección 4ALL

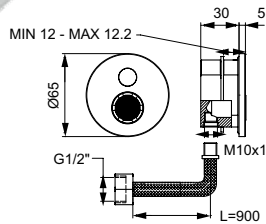

1,9 l/min



KTO1LD - P. 271

ART.	FINISHING	PACK.
560.10	CHROME	1
560.K3	CHROME	1

**560.20**

Dispenser sapone elettronico a parete, alimentazione a rete 230V, serie 4ALL

Electronic wall mounted soap dispenser, powered by mains 230V, 4ALL series

Distributeur électronique de savon mural, alimentation sur secteur 230V, série 4all

Dispensador de jabón electrónico de pared, alimentación de red 230V, colección 4ALL

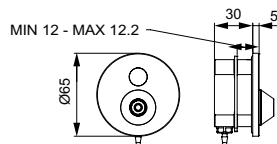

ART.	FINISHING	PACK.
560.20	CHROME	1
560.K3	CHROME	1

**560.30**

Asciugamani elettronico a parete, alimentazione 230V, serie 4ALL

Electronic wall-mounted hand dryer, powered by mains 230V, 4ALL series

Sèche-mains électronique mural, alimentation sur secteur 230V, série 4ALL

Secamanos electrónico de pared, alimentación de red 230V, colección 4ALL

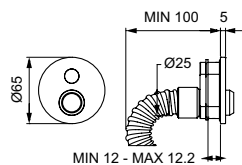

1,9 l/min



KTO1LD - P. 271

ART.	FINISHING	PACK.
560.30	CHROME	1
560.K3	CHROME	1

**560.K3**

Kit per lavabo completo di erogatore acqua, dispenser sapone e asciugamani ad aria; a comando elettronico e alimentazione a rete 230V. Serie 4ALL

Basin complete kit equipped with electronic water and soap dispenser and hand dryer, powered by mains 230V. 4ALL series

Ensemble à commande électronique pour lavabo équipé de distributeur d'eau et de savon et sèche-mains, alimentation sur secteur 230V. Série 4ALL

Conjunto con mando electrónico para lavabo multi-funcional equipado con dispensador de agua y de jabón y secamános. Alimentación de red 230V. Colección 4ALL



ART.	FINISHING	PACK.
560.K3	CHROME	1



**10560**

Lavabo multifunzione a parete realizzato in Solid Surface, completo di erogatore acqua, dispenser sapone e asciugamani ad aria; con armadietto e specchio; a comando elettronico e alimentazione a rete 230V; serie 4ALL

Multi-functional wall-mounted basin, in Solid Surface, equipped with electronic water dispenser, soap dispenser and hand dryer; with storage cabinet and mirror; powered by mains 230V; 4ALL series

Lavabo multifonctionnel mural en Solid Surface, équipé de distributeur d'eau, distributeur de savon et sèche-mains; avec armoire et miroir; à commande électronique et alimentation sur secteur 230V; série 4ALL

Lavabo multifunción a pared, en Solid Surface, equipado con dispensador de agua, dispensador de jabón y secamos; con armario y espejo; con mando electrónico y alimentación de red 230V; colección 4ALL

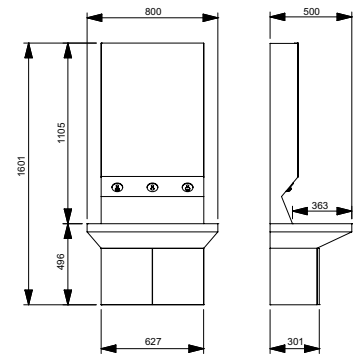

ART.	FINISHING	PACK.
10560	WHITE	1

**10565**

Lavabo multifunzione a parete realizzato in Solid Surface, completo di erogatore acqua, dispenser sapone e asciugamani ad aria; con specchio; a comando elettronico e alimentazione a rete 230V; serie 4ALL

Multi-functional wall-mounted basin, in Solid Surface, equipped with electronic water dispenser, soap dispenser and hand dryer; with mirror; powered by mains 230V; 4ALL series

Lavabo multifonctionnel mural en Solid Surface, équipé de distributeur d'eau, distributeur de savon et sèche-mains; avec miroir; à commande électronique et alimentation sur secteur 230V; série 4ALL

Lavabo multifunción a pared, en Solid Surface, equipado con dispensador de agua, dispensador de jabón y secamos; con espejo; con mando electrónico y alimentación de red 230V; colección 4ALL

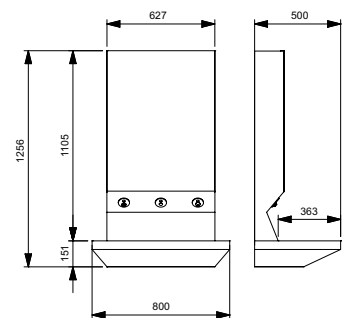

ART.	FINISHING	PACK.
10565	WHITE	1

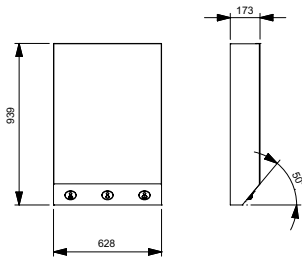
**10575**

Kit multifunzione a parete realizzato in Solid Surface, completo di erogatore acqua, dispenser sapone e asciugamani ad aria; con specchio; a comando elettronico e alimentazione a rete 230V; serie 4ALL

Multi-functional wall-mounted kit, in Solid Surface, equipped with electronic water dispenser, soap dispenser and hand dryer; with mirror; powered by mains 230V; 4ALL series

Ensemble multifonctionnel mural en Solid Surface, équipé de distributeur d'eau, distributeur de savon et sèche-mains; avec miroir; à commande électronique et alimentation sur secteur 230V; série 4ALL

Conjunto multifunción a pared, en Solid Surface, equipado con dispensador de agua, dispensador de jabón y secamanos; con espejo; con mando electrónico y alimentación de red 230V; colección 4ALL

1,9 l/min**KT01LD - P. 271**

ART.

FINISHING

PACK.

10575

WHITE

1

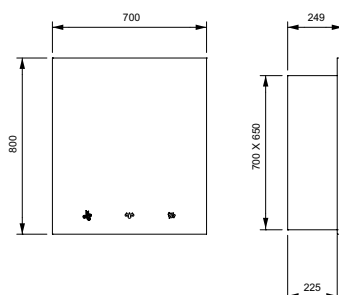
**10575/E**

Kit multifunzione a parete realizzato in multistrato laminato, completo di erogatore acqua, dispenser sapone e asciugamani ad aria; con specchio; a comando elettronico e alimentazione a rete 230V; serie 4ALL

Multi-functional wall-mounted kit, in multilayered laminate, equipped with electronic water dispenser, soap dispenser and hand dryer; with mirror; powered by mains 230V; 4ALL series

Ensemble multifonctionnel mural en contreplaqué stratifié, équipé de distributeur d'eau, distributeur de savon et sèche-mains; avec miroir; à commande électronique et alimentation sur secteur 230V; série 4ALL

Conjunto multifunción a pared, en contrachapado laminado, equipado con dispensador de agua, dispensador de jabón y secamanos; con espejo; con mando electrónico y alimentación de red 230V; colección 4ALL

1,9 l/min**KT01LD - P. 271**

ART.

FINISHING

PACK.

10575/E

MIRROR

1

**10580**

kit multifunzione a parete realizzato in Solid Surface antibatterica, completo di erogatore acqua, dispenser sapone e asciugamani ad aria; a comando elettronico e alimentazione a rete 230V; serie 4ALL

Multi-functional wall-mounted kit, in antibacterial Solid Surface, equipped with electronic water dispenser, soap dispenser and hand dryer; powered by mains 230V; 4ALL series

Ensemble multifonctionnel mural en Solid Surface antibactérien, équipé de distributeur d'eau, distributeur de savon et sèche-mains; à commande électronique et alimentation sur secteur 230V; série 4ALL

Conjunto multifunción a pared, en Solid Surface antibacteriano, equipado con dispensador de agua, dispensador de jabón y secamanos; con mando electrónico y alimentación de red 230V; colección 4ALL

1,9 l/min

KTO1LD - P. 271

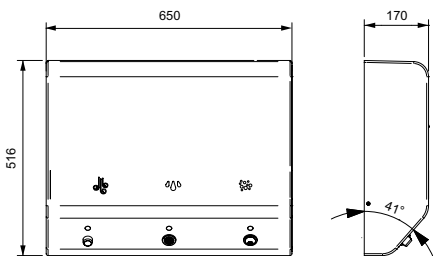

ART.

FINISHING

PACK.

10580

CHROME

1



**HLICX-09000**

Console multifunzione senza rubinetteria in Solid Surface, serie 4ALL
 Multi-functional console without taps in Solid Surface, 4 ALL Series
 Console multifonctionnel sans robinetterie en Solid Surface, série 4 ALL
 Consola multifunción sin grifería en Solid Surface, colección 4 ALL

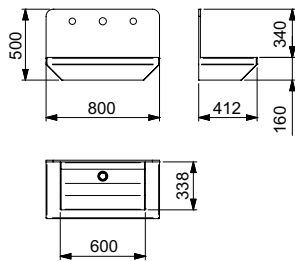

ART.	FINISHING	PACK.
HLICX-09000	CHROME	1

HLICX-08000

Console multifunzione senza rubinetteria in Solid Surface, serie 4ALL
 Multi-functional console without taps in Solid Surface, 4 ALL Series
 Console multifonctionnel sans robinetterie en Solid Surface, série 4 ALL
 Consola multifunción sin grifería en Solid Surface, colección 4 ALL

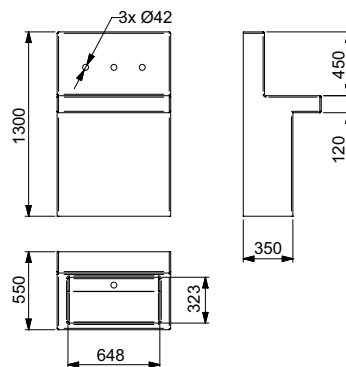

ART.	FINISHING	PACK.
HLICX-08000	CHROME	1

**HLICX-07000**

Piano bagno con lavabo cilindrico, in Solid Surface, serie 4ALL
 Countertop with cylindrical washbasin, in Solid Surface, 4 ALL Series
 Plan de toilette avec lavabo cylindrique, en Solid Surface, série 4ALL
 Encimera de baño con lavabo cilíndrico, en Solid Surface, colección 4All

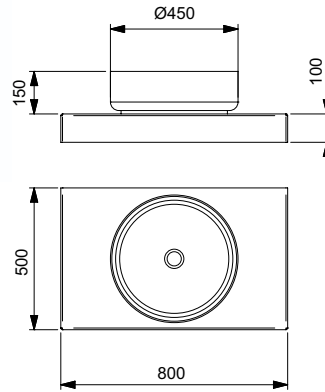
**SU RICHIESTA / ON DEMAND / SUR DEMAND / A PETICIÓN**

Variante in resina su richiesta
 Resin variant on demand
 Variante en résine sur demande
 Variante de resina a petición

ART.	FINISHING	PACK.
HLICX-07000	WHITE	1

**HLICX-06000**

Top bagno con lavabo ovale integrato, in Solid Surface, serie 4ALL
 Countertop with integrated oval basin, in Solid Surface, 4 ALL series
 Plan de toilette avec lavabo ovale intégré, en Solid Surface, série 4 ALL
 Encimera de baño con lavabo ovalado integrado, en Solid Surface, colección 4ALL

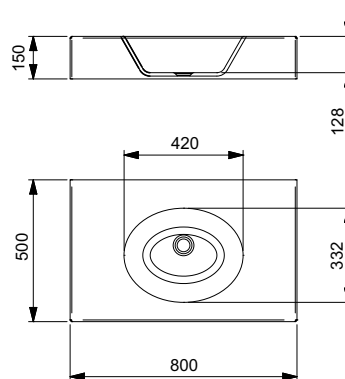
**SU RICHIESTA / ON DEMAND / SUR DEMAND / A PETICIÓN**

Variante in resina su richiesta
 Resin variant on demand
 Variante en résine sur demande
 Variante de resina a petición

ART.	FINISHING	PACK.
HLICX-06000	WHITE	1

**HLICX-05000**

Lavabo in Solid Surface con vasca inclinata, serie 4ALL
 Washbasin with sloping bowl, in Solid Surface, 4ALL series
 Lavabo en Solid Surface avec vasque inclinée, série 4ALL
 Lavabo con cubeta inclinada, en Solid Surface, colección 4ALL

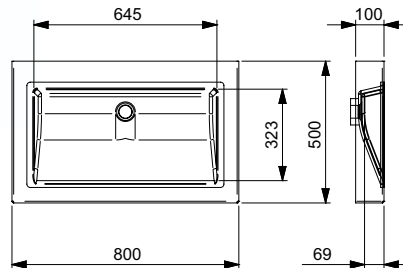
**SU RICHIESTA / ON DEMAND / SUR DEMAND / A PETICIÓN**

Variante in resina su richiesta
 Resin variant on demand
 Variante en résine sur demande
 Variante de resina a petición

ART.	FINISHING	PACK.
HLICX-05000	WHITE	1

HLICX-04000

Lavabo in Solid Surface con vasca rettangolare, serie 4ALL
 Washbasin with rectangular bowl, in Solid Surface, 4ALL series
 Lavabo en Solid Surface avec vasque rectangulaire, série 4ALL
 Lavabo con cubeta rectangular, en Solid Surface, colección 4ALL

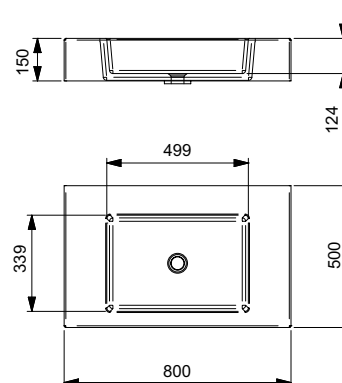
**SU RICHIESTA / ON DEMAND / SUR DEMAND / A PETICIÓN**

Variante in resina su richiesta
 Resin variant on demand
 Variante en résine sur demande
 Variante de resina a petición

ART.	FINISHING	PACK.
HLICX-04000	WHITE	1

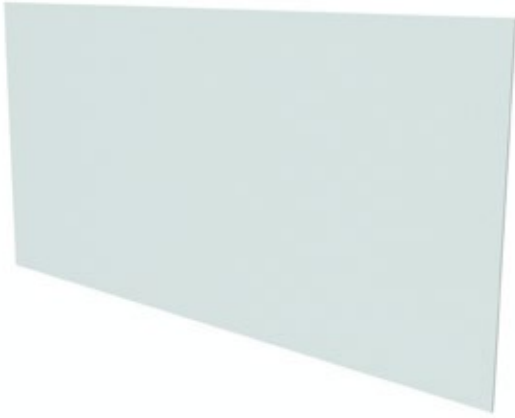
**HLICX-03000**

Specchio rettangolare 1000x500 mm fisso, serie 4ALL
Rectangular fixed mirror 1000x500 mm, 4ALL series
Miroir rectangulaire fixe 1000x500 mm, série 4ALL
Espejo rectangular fijo 1000x500 mm, colección 4ALL

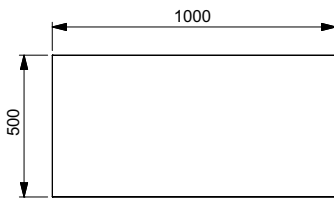

ART.	FINISHING	PACK.
HLICX-03000	MIRROR	1

**HLICX-02000**

Specchio tondo Ø500 mm fisso, serie 4ALL
Round fixed mirror Ø500 mm, 4ALL series
Miroir rond fixe Ø500 mm, série 4ALL
Espejo Redondo fijo Ø500 mm, colección 4ALL

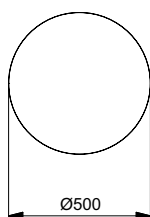

ART.	FINISHING	PACK.
HLICX-02000	MIRROR	1

**02650/2**

Asciugamani elettronico ad aria calda in ABS bianco
 Electronic hand dryer in white ABS with hot hair
 Sèche-mains électronique en ABS blanc avec air chaude
 Secamanos electrónico en ABS blanco, con aire caliente

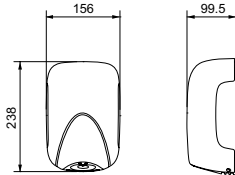

ART.	FINISHING	PACK.
02650/2	WHITE	1

**02650/3**

Asciugamani elettronico ad aria calda in acciaio inox satinato
 Electronic hand dryer in satin stainless steel, with hot hair
 Sèche-mains électronique, en acier inox brossé, avec air chaude
 Secamanos electrónico, en acero inox satinado, con aire caliente

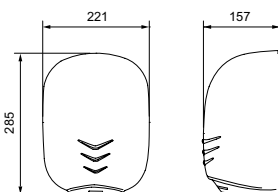

ART.	FINISHING	PACK.
02650/3	INOX	1







SERIE OTTO, L'INCONTRO DI DUE MONDI IN UN'UNICA SOLUZIONE

Ildral spa quest'anno con la serie OTTO propone una soluzione tecnica innovativa che coniuga stile e design in un unico prodotto. La serie OTTO propone diversi prodotti che nascono da ricerche approfondite sui materiali, sui processi industriali, sul mercato, sulle interazioni con l'utente, sulle innovazioni tecniche e tecnologiche. In collaborazione con il designer Luca Papini, abbiamo dato vita ad una gamma di prodotti che uniscono trasversalmente i due mondi dell'innovazione tecnologica e del design.

Il designer Luca Papini spiega:

"OTTO nasce sia in versione miscelatore che mono acqua, entrambe con il controllo dell'erogazione attraverso una fotocellula per garantire il massimo risparmio idrico.

La serie è disponibile nelle varie finiture cromo, bianco, nero opaco, oro, nickel e oro rosa / rame in finitura spazzolata.

Le forme morbide del rubinetto OTTO si enfatizzano per una cover nella parte superiore che aiuta l'ispezione e permette la personalizzazione bicolore del prodotto".

SERIES "OTTO" WHERE TWO WORLDS MEET IN A SINGLE SOLUTION

Series OTTO by Ildral S.p.a is an Innovative, well-engineered technical solution, with an appealing style oozing artistic charm - innovation and design all in one item. This series includes products of actual design born from extensive research on materials and industrial processes, on the market, on interactions with the user, on technical innovations and technology. In collaboration with the designer Luca Papini, we designed a range of items that unite the two worlds of the technical innovation and design.

The designer Luca Papini says:

"OTTO comes in a single-water version as well as in a mixer version, both of them with control of the water flow through a photocell to ensure maximum water savings. The series is available in chrome, white and matt black finishes as well as in gold, nickel and brushed finished rose gold/copper versions. The soft shapes of OTTO taps feature a cover in the upper part, that helps maintenance and allows customization of the product, by the change of the colours".

SÉRIE "OTTO", LA RENCONTRE DE DEUX MONDES EN UNE SEULE SOLUTION

Avec la série OTTO, la société "Ildral S.p.a" propose une solution technique innovatrice avec un design fascinant en un seul article. Cette série de produits, au design professionnel, est le fruit de recherches approfondies sur les matériaux, les processus industriels, la demande du marché, les interactions avec l'utilisateur et les innovations techniques/technologiques.

En collaboration avec le designer Luca Papini, nous avons créé une série de produits polyvalents qui combinent transversalement les deux mondes du design et de l'innovation technologique.

Le designer Luca Papini a affirmé: "OTTO est disponible en version mitigeur et version robinet simple, toutes deux dotées d'une photocellule qui contrôle l'écoulement de l'eau pour assurer une économie d'eau maximale. La série est disponible en différentes finitions: chrome, blanc et noir opaque, mais aussi en version nickel ou-rose/cuivre à finition brossée. Les formes souples du robinet OTTO sont caractérisées par l'ouverture supérieure assurant l'inspection et permettant de personnaliser le mitigeur à travers le change des couleurs".

SERIE "OTTO", EL ENCUENTRO DE DOS MONDOS EN UNA ÚNICA SOLUCIÓN

Ildral S.p.a, con la serie OTTO propone una solución técnica que combina innovación y diseño en el mismo producto. La serie OTTO resulta de investigaciones profundas sobre los materiales, los procesos industriales, el mercado, las interacciones con el usuario, las innovaciones técnicas y tecnológicas.

En colaboración con el diseñador Luca Papini, hemos realizado una gama de productos que unen transversalmente los dos mundos del diseño y del progreso tecnológico.

Le diseñador Luca Papini dice:

"OTTO nace tanto en versión mezclador como mono agua, ambas con el control del flujo de agua a través de una fotocélula, para garantizar el máximo ahorro hídrico. La serie está disponible en los diferentes acabados cromo, blanco y negro opaco, oro, níquel y oro rosado/cobre con acabado cepillado. Las formas suaves del grifo OTTO se caracterizan por una cobertura en la parte superior, que ayuda la inspección y permite la personalización del mezclador por medio del cambio de los colores".

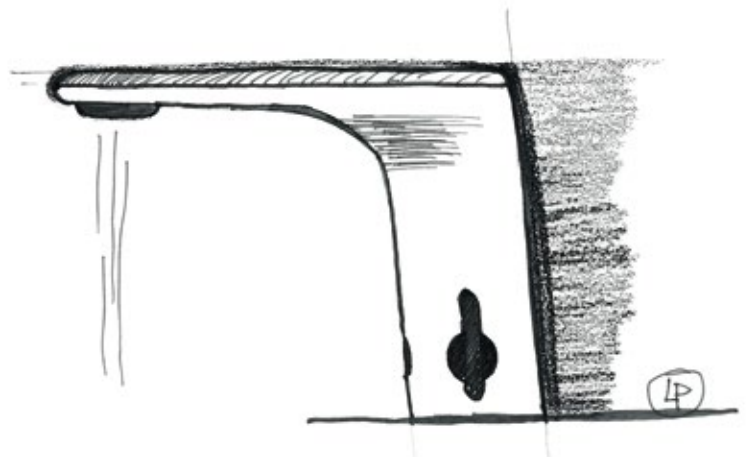

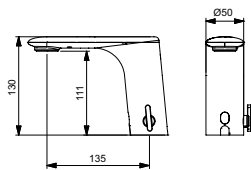

**500.12**Unified
Water Label

6 l/min

Miscelatore elettronico per lavabo, con alimentazione a batteria, serie OTTO

Electronic basin mixer, powered by battery, OTTO series

Mitigeur électronique pour lavabo, alimentation à piles, série OTTO

Mezclador electrónico para lavabo, con alimentación a batería, colección OTTO

500.12/R

Con alimentatore da rete 230V

Powered by mains 230V

Alimentation sur secteur 230V

Alimentación de red 230V

1,9 l/min



KTO1LD - P. 271

SU RICHIESTA / ON DEMAND / SUR DEMAND / A PETICIÓN

- D1** Nero - Black - Noir - Negro
E1 Bianco - White - Blanche - Blanco
O3 Oro - Gold - Or - Oro
2F Nickel - Nickel - Nickel - Níquel
N3 Rame - Copper - Cuivre - Cobre
R1 Grafite - Graphite - Graphite - Grafito

ART.	FINISHING	PACK.
500.12	CHROME	1
500.12/R	CHROME	1

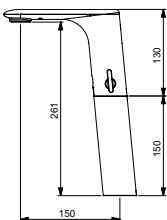
**500.12-150**

Miscelatore elettronico per lavabo, con alimentazione a batteria, con prolunga 150mm, serie OTTO

Electronic basin mixer with 150mm extension, powered by battery, OTTO series

Mitigeur électronique pour lavabo, alimentation à piles, avec extension 150mm, série OTTO

Mezclador electrónico para lavabo, con alimentación a batería, con prolongador 150mm, colección OTTO

500.12-150/R

Con alimentatore da rete 230V

Powered by mains 230V

Alimentation sur secteur 230V

Alimentación de red 230V

1,9 l/min



KTO1LD - P. 271

SU RICHIESTA / ON DEMAND / SUR DEMAND / A PETICIÓN

- D1** Nero - Black - Noir - Negro
E1 Bianco - White - Blanche - Blanco
O3 Oro - Gold - Or - Oro
2F Nickel - Nickel - Nickel - Níquel
N3 Rame - Copper - Cuivre - Cobre
R1 Grafite - Graphite - Graphite - Grafito

ART.	FINISHING	PACK.
500.12-150	CHROME	1
500.12-150/R	CHROME	1

**500.10**Unified
Water Label 6 l/min

Rubinetto elettronico per lavabo, con alimentazione a batteria, serie OTTO
 Electronic basin mixer, powered by battery, OTTO series
 Robinet électronique pour lavabo, alimentation à piles, série OTTO
 Grifo electrónico para lavabo, con alimentación a batería, colección OTTO

500.10/PM

Con pre-miscelatore manuale
 With manual pre-mixer
 Avec pré-mitigeur manuel
 Con pre-mezclador manual

1,9 l/min



KTO1LD - P. 271

500.10/PT

Con pre-miscelatore termostatico
 With thermostatic pre-mixer
 Avec pré-mitigeur thermostatique
 Con pre-mezclador termostático

500.10/R

Con alimentatore da rete 230V
 Powered by mains 230V
 Alimentation sur secteur 230V
 Alimentación de red 230V

500.10/RPM

Con alimentatore da rete 230V, con pre-miscelatore manuale
 Powered by mains 230V, with mechanical pre-mixer
 Alimentation sur secteur 230V, avec pré-mitigeur manuel
 Alimentación de red 230V, con pre-mezclador manual

500.10/RPT

Con alimentatore da rete 230V, con pre-miscelatore termostatico
 Powered by mains 230V, with thermostatic pre-mixer
 Alimentation sur secteur 230V, avec pré-mitigeur thermostatique
 Alimentación de red 230V, con pre-mezclador termostático

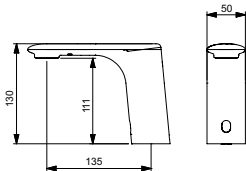
**SU RICHIESTA / ON DEMAND / SUR DEMAND / A PETICIÓN**

D1 Nero - Black - Noir - Negro
E1 Bianco - White - Blanche - Blanco
O3 Oro - Gold - Or - Oro
2F Nickel - Nickel - Nickel - Níquel
N3 Rame - Copper - Cuivre - Cobre
R1 Grafite - Graphite - Graphite - Grafito

ART.

FINISHING

PACK.

500.10	CHROME	1
500.10/PM	CHROME	1
500.10/PT	CHROME	1
500.10/R	CHROME	1
500.10/RPM	CHROME	1
500.10/RPT	CHROME	1

**500.10-150**

Rubinetto elettronico per lavabo con alimentazione a batteria, con prolunga 150mm, serie OTTO

Electronic basin tap with 150mm extension, powered by battery, OTTO series

Robinet électronique pour lavabo, alimentation à piles, avec extension 150mm, série OTTO

Grifo electrónico para lavabo, con alimentación a batería, con prolongador 150mm, colección OTTO

500.10-150/PM

Con pre-miscelatore manuale

With manual pre-mixer

Avec pré-mitigeur manuel

Con pre-mezclador manual

500.10-150/PT

Con pre-miscelatore termostatico

With thermostatic pre-mixer

Avec pré-mitigeur thermostatique

Con pre-mezclador termostático

500.10-150/R

Con alimentatore da rete 230V

Powered by mains 230V

Alimentation sur secteur 230V

Alimentación de red 230V

500.10-150/RPM

Con alimentatore da rete 230V, con pre-miscelatore manuale

Powered by mains 230V, with mechanical pre-mixer

Alimentation sur secteur 230V, avec pré-mitigeur manuel

Alimentación de red 230V, con pre-mezclador manual

500.10-150/RPT

Con alimentatore da rete 230V, con pre-miscelatore termostatico

Powered by mains 230V, with thermostatic pre-mixer

Alimentation sur secteur 230V, avec pré-mitigeur thermostatique

Alimentación de red 230V, con pre-mezclador termostático

1,9 l/min

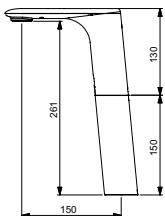

KTO1LD - P. 271

**SU RICHIESTA / ON DEMAND / SUR DEMAND / A PETICIÓN**

D1 Nero - Black - Noir - Negro
E1 Bianco - White - Blanche - Blanco
O3 Oro - Gold - Or - Oro
2F Nickel - Nickel - Nickel - Níquel
N3 Rame - Copper - Cuivre - Cobre
R1 Grafite - Graphite - Graphite - Grafito

ART.	FINISHING	PACK.
500.10-150	CHROME	1
500.10-150/PM	CHROME	1
500.10-150/PT	CHROME	1
500.10-150/R	CHROME	1
500.10-150/RPM	CHROME	1
500.10-150/RPT	CHROME	1

**545.12**Unified
Water Label

6 l/min

Miscelatore elettronico per lavabo con alimentazione a batteria, serie 45
 Electronic basin mixer powered by battery, 45 series
 Mitigeur électronique pour lavabo, alimentation à piles, série 45
 Mezclador electrónico para lavabo, alimentación a batería, colección 45

545.12/R

Con alimentatore da rete 230V
 Powered by mains 230V
 Alimentation sur secteur 230V
 Alimentación de red 230V

1,9 l/min

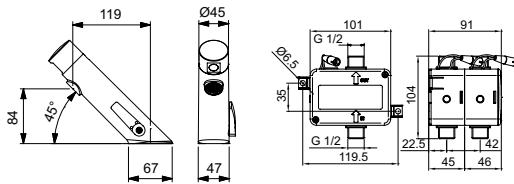

KTO1LD - P. 271

**SU RICHIESTA / ON DEMAND / SUR DEMAND / A PETICIÓN**

D1 Nero - Black - Noir - Negro
E1 Bianco - White - Blanche - Blanco
O3 Oro - Gold - Or - Oro
2F Nickel - Nickel - Nickel - Níquel
N3 Rame - Copper - Cuivre - Cobre
R1 Grafite - Graphite - Graphite - Grafito

ART.	FINISHING	PACK.
545.12	CHROME	1
545.12/R	CHROME	1

**545.10**Unified
Water Label

6 l/min

Rubinetto elettronico per lavabo alimentazione a batteria, serie 45
 Electronic basin tap, powered by battery, 45 series
 Robinet électronique pour lavabo, alimentation à piles, série 45
 Grifo electrónico para lavabo con alimentación a batería, colección 45

545.10/R

Con alimentatore da rete 230V
 Powered by mains 230V
 Alimentation sur secteur 230V
 Alimentación de red 230V

1,9 l/min

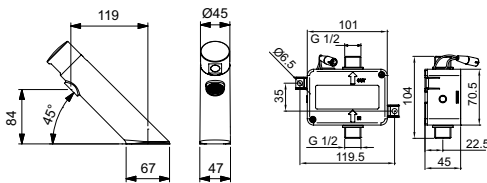

KTO1LD - P. 271

**SU RICHIESTA / ON DEMAND / SUR DEMAND / A PETICIÓN**

D1 Nero - Black - Noir - Negro
E1 Bianco - White - Blanche - Blanco
O3 Oro - Gold - Or - Oro
2F Nickel - Nickel - Nickel - Níquel
N3 Rame - Copper - Cuivre - Cobre
R1 Grafite - Graphite - Graphite - Grafito

ART.	FINISHING	PACK.
545.10	CHROME	1
545.10/R	CHROME	1

**02512**Unified
Water Label 6 l/min

Miscelatore elettronico per lavabo, con alimentazione a batteria, serie ONE

Electronic basin mixer, powered by battery, ONE series

Mitigeur électronique pour lavabo, alimentation à piles, série ONE

Mezclador electrónico para lavabo, con alimentación a batería, colección ONE

02512/R

Con alimentatore da rete 230V

Powered by mains 230V

Alimentation sur secteur 230V

Alimentación de red 230V

1,9 l/min

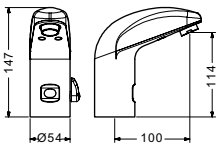

KTO2LD - P. 271

**SU RICHIESTA / ON DEMAND / SUR DEMAND / A PETICIÓN**

- D1** Nero - Black - Noir - Negro
E1 Bianco - White - Blanche - Blanco
O3 Oro - Gold - Or - Oro
2F Nickel - Nickel - Nickel - Níquel
N3 Rame - Copper - Cuivre - Cobre
R1 Grafite - Graphite - Graphite - Grafito

ART.	FINISHING	PACK.
02512	CHROME	1
02512/R	CHROME	1



**02511**

Unified Water Label 6 l/min

Rubinetto elettronico per lavabo, alimentazione a batteria, serie ONE

Electronic basin mixer, powered by battery, ONE series

Mitigeur électronique pour lavabo, alimentation à piles, série ONE

Mezclador electrónico para lavabo, con alimentación a batería, colección ONE

02511/PM

Con pre-miscelatore manuale

With manual pre-mixer

Avec pré-mitigeur manuel

Con pre-mezclador manual

1,9 l/min



KTO2LD - P. 271

02511/PT

Con pre-miscelatore termostatico

With thermostatic pre-mixer

Avec pré-mitigeur thermostatique

Con pre-mezclador termostático

02511/R

Con alimentatore da rete 230V

Powered by mains 230V

Alimentation sur secteur 230V

Alimentación de red 230V

02511/RPM

Con alimentatore da rete 230V, con pre-miscelatore manuale

Powered by mains 230V, with mechanical pre-mixer

Alimentation sur secteur 230V, avec pré-mitigeur manuel

Alimentación de red 230V, con pre-mezclador manual

02511/RPT

Con alimentatore da rete 230V, con pre-miscelatore termostatico

Powered by mains 230V, with thermostatic pre-mixer

Alimentation sur secteur 230V, avec pré-mitigeur thermostatique

Alimentación de red 230V, con pre-mezclador termostático

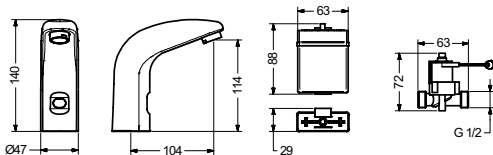
**SU RICHIESTA / ON DEMAND / SUR DEMAND / A PETICIÓN**

D1 Nero - Black - Noir - Negro
E1 Bianco - White - Blanche - Blanco
O3 Oro - Gold - Or - Oro
2F Nickel - Nickel - Nickel - Níquel
N3 Rame - Copper - Cuivre - Cobre
R1 Grafite - Graphite - Graphite - Grafito

ART.

FINISHING

PACK.

02511

CHROME

1

02511/PM

CHROME

1

02511/PT

CHROME

1

02511/R

CHROME

1

02511/RPM

CHROME

1

02511/RPT

CHROME

1

**02504**Unified
Water Label

5,7 l/min

Miscelatore elettronico per lavabo, con alimentazione a batteria, serie CURVE
 Electronic basin mixer, powered by battery, CURVE series
 Mitigeur électronique pour lavabo, alimentation à piles, série CURVE
 Mezclador electrónico para lavabo, con alimentación a batería, colección CURVE

02504/R

Con alimentatore da rete 230V
 Powered by mains 230V
 Alimentation sur secteur 230V
 Alimentación de red 230V

1,9 l/min

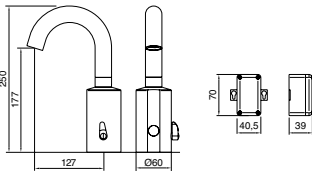

KT03LD - P. 271

**SU RICHIESTA / ON DEMAND / SUR DEMAND / A PETICIÓN**

- D1** Nero - Black - Noir - Negro
E1 Bianco - White - Blanche - Blanco
O3 Oro - Gold - Or - Oro
2F Nickel - Nickel - Nickel - Níquel
N3 Rame - Copper - Cuivre - Cobre
R1 Grafite - Graphite - Graphite - Grafito

ART.	FINISHING	PACK.
02504	CHROME	1
02504/R	CHROME	1

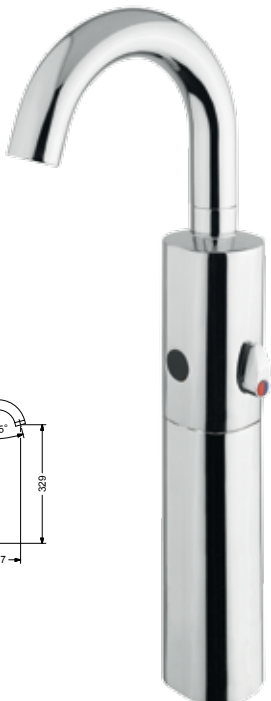
**02504/1**Unified
Water Label

5,7 l/min

Miscelatore elettronico per lavabo con prolunga, con alimentazione a batteria, serie CURVE
 Electronic basin mixer with extension, powered by battery, CURVE series
 Mitigeur électronique pour lavabo avec extension, alimentation à piles, série CURVE
 Mezclador electrónico para lavabo con prolongador, alimentación a batería, colección CURVE

02504/1R

Con alimentatore da rete 230V
 Powered by mains 230V
 Alimentation sur secteur 230V
 Alimentación de red 230V

1,9 l/min

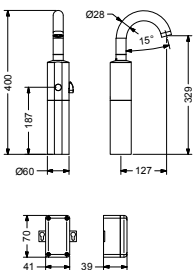

KT03LD - P. 271

**SU RICHIESTA / ON DEMAND / SUR DEMAND / A PETICIÓN**

- D1** Nero - Black - Noir - Negro
E1 Bianco - White - Blanche - Blanco
O3 Oro - Gold - Or - Oro
2F Nickel - Nickel - Nickel - Níquel
N3 Rame - Copper - Cuivre - Cobre
R1 Grafite - Graphite - Graphite - Grafito

ART.	FINISHING	PACK.
02504/1	CHROME	1
02504/1R	CHROME	1

**02505**Unified
Water Label

6 l/min

Miscelatore elettronico per lavabo, con canna alta fissa, alimentazione a batteria, serie CURVE

Electronic basin mixer with fixed high spout, powered by battery, CURVE series

Mitigeur électronique pour lavabo avec bec haut fixe, alimentation à piles, série CURVE

Mezclador electrónico para lavabo con caño alto fijo, alimentación a batería, colección CURVE

02505/R

230 volt

Con alimentatore da rete 230V

Powered by mains 230V

Alimentation sur secteur 230V

Alimentación de red 230V

1,9 l/min

KT03LD - P. 271

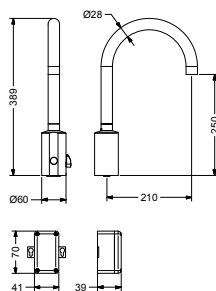
**SU RICHIESTA / ON DEMAND / SUR DEMAND / A PETICIÓN**

D1 Nero - Black - Noir - Negro
E1 Bianco - White - Blanche - Blanco
O3 Oro - Gold - Or - Oro
2F Nickel - Nickel - Nickel - Níquel
N3 Rame - Copper - Cuivre - Cobre
R1 Grafite - Graphite - Graphite - Grafito

ART.

FINISHING

PACK.

02505
02505/RCHROME
CHROME1
1

**02503/1**Unified
Water Label

5,7 l/min

Rubinetto elettronico per lavabo con alimentazione a batteria, serie CURVE
 Electronic basin tap, powered by battery, CURVE series
 Robinet électronique pour lavabo, alimentation à piles, série CURVE
 Grifo electrónico para lavabo, alimentación a batería, colección CURVE

02503/1PM

Con pre-miscelatore manuale
 With manual pre-mixer
 Avec pré-mitigeur manuel
 Con pre-mezclador manual

02503/1PT

Con pre-miscelatore termostatico
 With thermostatic pre-mixer
 Avec pré-mitigeur thermostatique
 Con pre-mezclador termostático

02503/1R

Con alimentatore da rete 230V
 Powered by mains 230V
 Alimentation sur secteur 230V
 Alimentación de red 230V

02503/1RPM

Con alimentatore da rete 230V, con pre-miscelatore manuale
 Powered by mains 230V, with mechanical pre-mixer
 Alimentation sur secteur 230V, avec pré-mitigeur manuel
 Alimentación de red 230V, con pre-mezclador manual

02503/1RPT

Con alimentatore da rete 230V, con pre-miscelatore termostatico
 Powered by mains 230V, with thermostatic pre-mixer
 Alimentation sur secteur 230V, avec pré-mitigeur thermostatique
 Alimentación de red 230V, con pre-mezclador termostático

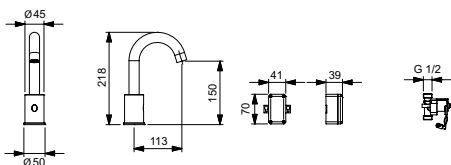
**1,9 l/min****KTO4LD - P. 271****SU RICHIESTA / ON DEMAND / SUR DEMAND / A PETICIÓN**

D1 Nero - Black - Noir - Negro
E1 Bianco - White - Blanche - Blanco
O3 Oro - Gold - Or - Oro
2F Nickel - Nickel - Nickel - Níquel
N3 Rame - Copper - Cuivre - Cobre
R1 Grafite - Graphite - Graphite - Grafito

ART.	FINISHING	PACK.
02503/1	CHROME	1
02503/1PM	CHROME	1
02503/1PT	CHROME	1
02503/1R	CHROME	1
02503/1RPM	CHROME	1
02503/1RPT	CHROME	1

**02503/1S**

Dispenser sapone elettronico, alimentazione a rete 230V
 Electronic soap dispenser, powered by mains 230V
 Distributeur électronique da savon, alimentation sur secteur 230V
 Dispensador de Jabón electrónico, alimentación de red 230V

SU RICHIESTA / ON DEMAND / SUR DEMAND / A PETICIÓN

D1 Nero - Black - Noir - Negro
E1 Bianco - White - Blanche - Blanco
O3 Oro - Gold - Or - Oro
2F Nickel - Nickel - Nickel - Níquel
N3 Rame - Copper - Cuivre - Cobre
R1 Grafite - Graphite - Graphite - Grafito

ART.	FINISHING	PACK.
02503/1S	CHROME	1

**02582S**

Dispenser sapone elettronico, alimentazione a rete 230V
 Electronic soap dispenser, powered by mains 230V
 Distributeur électronique da savon, alimentation sur secteur 230V
 Dispensador de Jabón electrónico, alimentación de red 230V

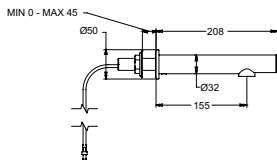
**SU RICHIESTA / ON DEMAND / SUR DEMAND / A PETICIÓN**

D1 Nero - Black - Noir - Negro
E1 Bianco - White - Blanche - Blanco
O3 Oro - Gold - Or - Oro
2F Nickel - Nickel - Nickel - Níquel
N3 Rame - Copper - Cuivre - Cobre
R1 Grafite - Graphite - Graphite - Grafito

ART.	FINISHING	PACK.
02582S	CHROME	1

**700.A9**

Miscelatore elettronico per lavabo da incasso con bocca di erogazione, alimentazione a batteria, serie 700

Concealed electronic basin mixer with spout, powered by battery, 700 series

Mitigeur pour lavabo électronique encastré avec bec, alimentation à piles, série 700

Mezclador electrónico para lavabo con caño, fijación empotrada, alimentación con batería colección 700

700.A9/R

Con alimentatore da rete 230V

Powered by mains 230V

Alimentation sur secteur 230V

Alimentación de red 230V

1,9 l/min

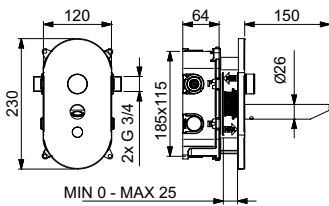

KTO4LD - P. 271

**SU RICHIESTA / ON DEMAND / SUR DEMAND / A PETICIÓN**

- D1** Nero - Black - Noir - Negro
E1 Bianco - White - Blanche - Blanco
O3 Oro - Gold - Or - Oro
2F Nickel - Nickel - Nickel - Níquel
N3 Rame - Copper - Cuivre - Cobre
R1 Grafite - Graphite - Graphite - Grafito

ART.	FINISHING	PACK.
700.A9	CHROME	1
700.A9/R	CHROME	1

**700.A9/1**

Unified Water Label 6 l/min

Miscelatore elettronico per lavabo da incasso con bocca di erogazione, alimentazione a batteria, serie 700

Concealed electronic basin mixer with spout, powered by battery, 700 series

Mitigeur pour lavabo électronique encastré avec bec, alimentation à piles, série 700

Mezclador electrónico para lavabo con caño, fijación empotrada, alimentación con batería colección 700

700.A9/1R

Con alimentatore da rete 230V

Powered by mains 230V

Alimentation sur secteur 230V

Alimentación de red 230V

1,9 l/min

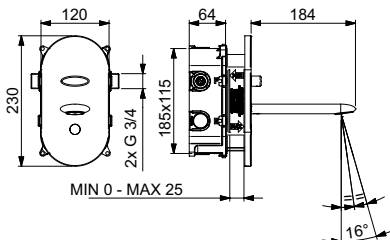

KTO1LD - P. 271

**SU RICHIESTA / ON DEMAND / SUR DEMAND / A PETICIÓN**

- D1** Nero - Black - Noir - Negro
E1 Bianco - White - Blanche - Blanco
O3 Oro - Gold - Or - Oro
2F Nickel - Nickel - Nickel - Níquel
N3 Rame - Copper - Cuivre - Cobre
R1 Grafite - Graphite - Graphite - Grafito

ART.	FINISHING	PACK.
700.A9/1	CHROME	1
700.A9/1R	CHROME	1

**700.A8**

Rubinetto elettronico per lavabo da incasso con bocca di erogazione, alimentazione a batteria, serie 700

Concealed electronic basin tap with spout, powered by battery, 700 series

Robinet pour lavabo électronique encastré avec bec, alimentation à piles, série 700

Grifo electrónico para lavabo con caño, fijación empotrada, alimentación con batería, colección 700

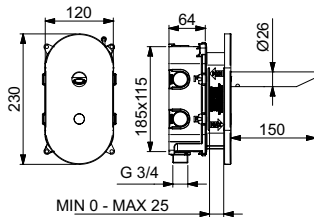
**700.A8/R**

Con alimentatore da rete 230V

Powered by mains 230V

Alimentation sur secteur 230V

Alimentación de red 230V

1,9 l/min



KTO4LD - P. 271

SU RICHIESTA / ON DEMAND / SUR DEMAND / A PETICIÓN

- D1** Nero - Black - Noir - Negro
E1 Bianco - White - Blanche - Blanco
O3 Oro - Gold - Or - Oro
2F Nickel - Nickel - Nickel - Níquel
N3 Rame - Copper - Cuivre - Cobre
R1 Grafite - Graphite - Graphite - Grafito

ART.	FINISHING	PACK.
700.A8	CHROME	1
700.A8/R	CHROME	1

**700.A8/1**

Unified Water Label 6 l/min

Rubinetto elettronico per lavabo da incasso con bocca di erogazione, alimentazione a batteria, serie 700

Concealed electronic basin tap with spout, powered by battery, 700 series

Robinet pour lavabo électronique encastré avec bec, alimentation à piles, série 700

Grifo electrónico para lavabo con caño, fijación empotrada, alimentación con batería, colección 700

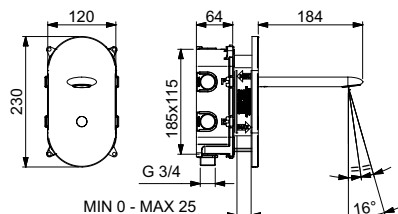
**700.A8/1R**

Con alimentatore da rete 230V

Powered by mains 230V

Alimentation sur secteur 230V

Alimentación de red 230V

1,9 l/min



KTO1LD - P. 271

SU RICHIESTA / ON DEMAND / SUR DEMAND / A PETICIÓN

- D1** Nero - Black - Noir - Negro
E1 Bianco - White - Blanche - Blanco
O3 Oro - Gold - Or - Oro
2F Nickel - Nickel - Nickel - Níquel
N3 Rame - Copper - Cuivre - Cobre
R1 Grafite - Graphite - Graphite - Grafito

ART.	FINISHING	PACK.
700.A8/1	CHROME	1
700.A8/1R	CHROME	1

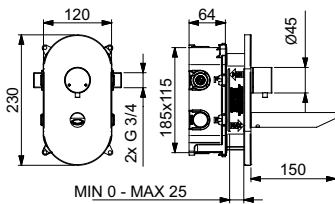
**700.B1/1**

Miscelatore termostatico temporizzato per lavabo da incasso con bocca di erogazione, serie 700

Concealed self closing thermostatic basin mixer with spout, 700 series

Mitigeur thermostatique temporisé pour lavabo encastré avec bec, série 700

Mezclador termostático temporizado para lavabo, fijación empotrada con caño, colección 700

1,9 l/min



KTO4LD - P. 271

SU RICHIESTA / ON DEMAND / SUR DEMAND / A PETICIÓN

- D1** Nero - Black - Noir - Negro
E1 Bianco - White - Blanche - Blanco
O3 Oro - Gold - Or - Oro
2F Nickel - Nickel - Nickel - Níquel
N3 Rame - Copper - Cuivre - Cobre
R1 Grafite - Graphite - Graphite - Grafito

ART.	FINISHING	PACK.
700.B1/1	CHROME	1

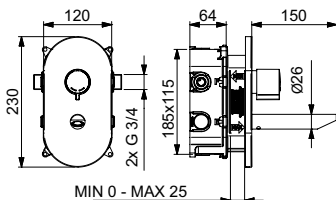
**700.B2/1**

Miscelatore temporizzato per lavabo da incasso con bocca di erogazione, serie 700

Concealed self closing basin mixer with spout, 700 series

Mitigeur temporisé pour lavabo encastré avec bec, série 700

Mezclador temporizado para lavabo, fijación empotrada con caño, colección 700

700.B2/1F

Con pulsante antibloccaggio

With vandal proof push button

Avec poussoir anti-bloque

Con pulsador anti-bloqueo

1,9 l/min



KTO4LD - P. 271

SU RICHIESTA / ON DEMAND / SUR DEMAND / A PETICIÓN

- D1** Nero - Black - Noir - Negro
E1 Bianco - White - Blanche - Blanco
O3 Oro - Gold - Or - Oro
2F Nickel - Nickel - Nickel - Níquel
N3 Rame - Copper - Cuivre - Cobre
R1 Grafite - Graphite - Graphite - Grafito

ART.	FINISHING	PACK.
700.B2/1	CHROME	1
700.B2/1F	CHROME	1

**700.B3/1**

Miscelatore termostatico per lavabo da incasso con bocca di erogazione, serie 700
 Concealed thermostatic basin mixer with spout 700 series
 Mitigeur thermostatique pour lavabo encastré avec bec, série 700
 Mezclador termostático para lavabo, fijación empotrada con caño, colección 700

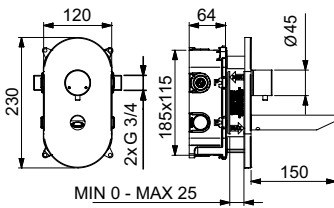
1,9 l/min**KTO4LD - P. 271****SU RICHIESTA / ON DEMAND / SUR DEMAND / A PETICIÓN**

- D1** Nero - Black - Noir - Negro
- E1** Bianco - White - Blanche - Blanco
- O3** Oro - Gold - Or - Oro
- 2F** Nickel - Nickel - Nickel - Níquel
- N3** Rame - Copper - Cuivre - Cobre
- R1** Grafite - Graphite - Graphite - Grafito

ART.	FINISHING	PACK.
700.B3/1	CHROME	1

**700.B4/1**

Rubinetto temporizzato per lavabo da incasso con bocca di erogazione, serie 700
 Concealed self closing basin tap with spout, 700 series
 Robinet pour lavabo temporisé encastré avec bec, série 700
 Grifo temporizado para lavabo con caño, fijación empotrada, colección 700

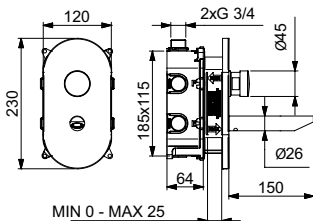
1,9 l/min**KTO4LD - P. 271****SU RICHIESTA / ON DEMAND / SUR DEMAND / A PETICIÓN**

- D1** Nero - Black - Noir - Negro
- E1** Bianco - White - Blanche - Blanco
- O3** Oro - Gold - Or - Oro
- 2F** Nickel - Nickel - Nickel - Níquel
- N3** Rame - Copper - Cuivre - Cobre
- R1** Grafite - Graphite - Graphite - Grafito

ART.	FINISHING	PACK.
700.B4/1	CHROME	1

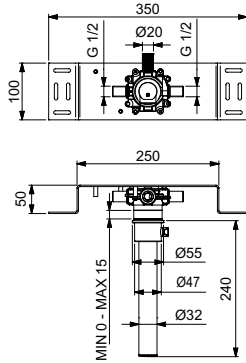
**170M2-02000**Unified
Water Label

6 l/min

Miscelatore elettronico da incasso per lavabo con bocca di erogazione, alimentazione a batteria, serie 700

Concealed electronic basin mixer with spout, powered by battery, 700 series

Mitigeur électronique pour lavabo encastré avec bec, alimentation à piles, série 700

Mezclador electrónico lavabo fijación empotrada con caño, alimentación con batería, colección 700

170M2-03000

Con alimentatore da rete 230V

Powered by mains 230V

Alimentation sur secteur 230V

Alimentación de red 230V

1,9 l/min



KTO4LD - P. 271

**ON
OFF
SYSTEM****SU RICHIESTA / ON DEMAND / SUR DEMAND / A PETICIÓN**

- D1** Nero - Black - Noir - Negro
E1 Bianco - White - Blanche - Blanco
O3 Oro - Gold - Or - Oro
2F Nickel - Nickel - Nickel - Níquel
N3 Rame - Copper - Cuivre - Cobre
R1 Grafite - Graphite - Graphite - Grafito

ART.	FINISHING	PACK.
170M2-02000	CHROME	1
170M2-03000		

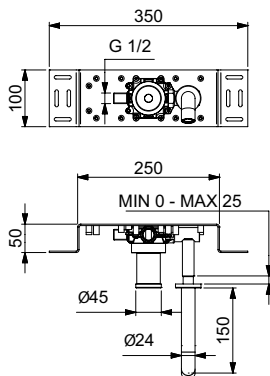
**170N2-02000**Unified
Water Label

6 l/min

Rubinetto elettronico da incasso per lavabo con bocca di erogazione, alimentazione a batteria, serie 700

Concealed electronic basin tap with spout, powered by battery, 700 series

Robinet électronique pour lavabo encastré avec bec, alimentation à piles, série 700

Grifo electrónico lavabo fijación empotrada con caño, alimentación con batería, colección 700

170N2-03000

Con alimentatore da rete 230V

Powered by mains 230V

Alimentation sur secteur 230V

Alimentación de red 230V

1,9 l/min



KTO4LD - P. 271

**ON
OFF
SYSTEM****SU RICHIESTA / ON DEMAND / SUR DEMAND / A PETICIÓN**

- D1** Nero - Black - Noir - Negro
E1 Bianco - White - Blanche - Blanco
O3 Oro - Gold - Or - Oro
2F Nickel - Nickel - Nickel - Níquel
N3 Rame - Copper - Cuivre - Cobre
R1 Grafite - Graphite - Graphite - Grafito

ART.	FINISHING	PACK.
170N2-02000	CHROME	1
170N2-03000		

**170M2-00000**

Unified Water Label 6 l/min

Miscelatore elettronico da incasso per lavabo con bocca di erogazione, alimentazione a batteria, serie 700

Concealed electronic basin mixer with spout, powered by battery, 700 series

Mitigreur électronique de lavabo encastré avec bec, alimentation à piles, série 700

Mezclador electrónico lavabo fijación empotrada con caño, alimentación con batería, colección 700

170M2-01000

Con alimentatore da rete 230V

Powered by mains 230V

Alimentation sur secteur 230V

Alimentación de red 230V

1,9 l/min

**KTO4LD - P. 271****SU RICHIESTA / ON DEMAND / SUR DEMAND / A PETICIÓN**

- D1** Nero - Black - Noir - Negro
E1 Bianco - White - Blanche - Blanco
O3 Oro - Gold - Or - Oro
2F Nickel - Nickel - Nickel - Níquel
N3 Rame - Copper - Cuivre - Cobre
R1 Grafite - Graphite - Graphite - Grafito

ART.	FINISHING	PACK.
170M2-00000	CHROME	1
170M2-01000	CHROME	1

**170N2-00000**

Unified Water Label 6 l/min

Rubinetto elettronico da incasso per lavabo con bocca di erogazione, alimentazione a batteria, serie 700

Concealed electronic basin tap with spout, powered by battery, 700 series

Robinet électronique de lavabo encastré avec bec, alimentation à piles, série 700

Grifo electrónico lavabo fijación empotrada con caño, alimentación con batería, colección 700

170N2-01000

Con alimentatore da rete 230V

Powered by mains 230V

Alimentation sur secteur 230V

Alimentación de red 230V

1,9 l/min

**KTO4LD - P. 271****SU RICHIESTA / ON DEMAND / SUR DEMAND / A PETICIÓN**

- D1** Nero - Black - Noir - Negro
E1 Bianco - White - Blanche - Blanco
O3 Oro - Gold - Or - Oro
2F Nickel - Nickel - Nickel - Níquel
N3 Rame - Copper - Cuivre - Cobre
R1 Grafite - Graphite - Graphite - Grafito

ART.	FINISHING	PACK.
170N2-00000	CHROME	1
170N2-01000	CHROME	1

**02584**Unified
Water Label

6 l/min

Miscelatore elettronico lavabo per pareti in **cartongesso**, alimentazione a batteria, serie ONE

Electronic basin mixer for **plasterboard walls**, powered by battery, ONE series

Mitigeur électronique lavabo pour **murs en piacopâtre**, alimentation à piles, série ONE

Mezclador lavabo electrónico para **paredes en pladur**, alimentación a batería, colección ONE

02584/R

Con alimentatore da rete 230V

Powered by mains 230V

Alimentation sur secteur 230V

Alimentación de red 230V

1,9 l/min

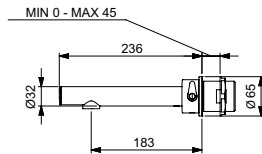

KTO1LD - P. 271

**SU RICHIESTA / ON DEMAND / SUR DEMAND / A PETICIÓN**

- D1** Nero - Black - Noir - Negro
- E1** Bianco - White - Blanche - Blanco
- O3** Oro - Gold - Or - Oro
- 2F** Nickel - Nickel - Nickel - Níquel
- N3** Rame - Copper - Cuivre - Cobre
- R1** Grafite - Graphite - Graphite - Grafito

ART.	FINISHING	PACK.
02584	CHROME	1
02584/R	CHROME	1

**02582**Unified
Water Label

6 l/min

Rubinetto elettronico lavabo per pareti in **cartongesso**, alimentazione a batteria, serie ONE

Electronic basin tap for **plasterboard walls**, powered by battery, ONE series

Robinet lavabo électronique pour **murs en piacopâtre**, alimentation à piles, série ONE

Grifo lavabo electrónico para **paredes de pladur**, alimentación a batería, colección ONE

02582/R

Con alimentatore da rete 230V

Powered by mains 230V

Alimentation sur secteur 230V

Alimentación de red 230V

1,9 l/min

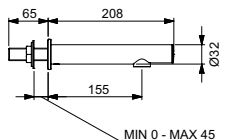

KTO1LD - P. 271

**SU RICHIESTA / ON DEMAND / SUR DEMAND / A PETICIÓN**

- D1** Nero - Black - Noir - Negro
- E1** Bianco - White - Blanche - Blanco
- O3** Oro - Gold - Or - Oro
- 2F** Nickel - Nickel - Nickel - Níquel
- N3** Rame - Copper - Cuivre - Cobre
- R1** Grafite - Graphite - Graphite - Grafito

ART.	FINISHING	PACK.
02582	CHROME	1
02582/R	CHROME	1

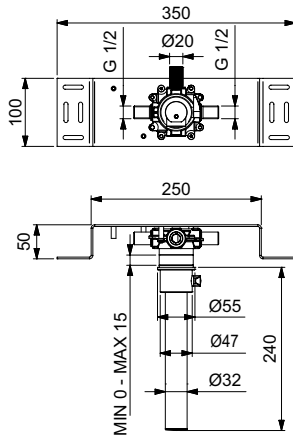
**I70M2-04000**

Miscelatore elettronico lavabo, alimentazione a batteria, serie 700
 Electronic basin mixer, powered by battery, 700 series
 Mitigeur électronique lavabo, alimentation à piles, série 700
 Mezclador electrónico lavabo, alimentación a batería, colección 700

I70M2-05000

Con alimentatore da rete 230V
 Powered by mains 230V
 Alimentation sur secteur 230V
 Alimentación de red 230V

1,9 l/min



KTO1LD - P. 271

SU RICHIESTA / ON DEMAND / SUR DEMAND / A PETICIÓN

D1 Nero - Black - Noir - Negro
E1 Bianco - White - Blanche - Blanco
O3 Oro - Gold - Or - Oro
2F Nickel - Nickel - Nickel - Níquel
N3 Rame - Copper - Cuivre - Cobre
R1 Grafite - Graphite - Graphite - Grafito

ART.	FINISHING	PACK.
I70M2-04000	CHROME	1
I70M2-05000	CHROME	1

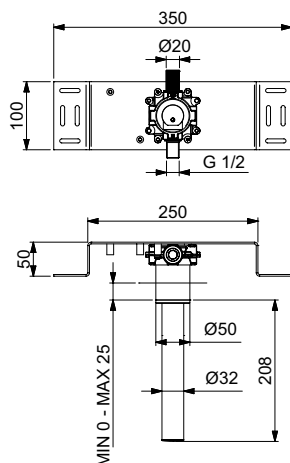
**I70N2-04000**

Rubinetto elettronico lavabo, alimentazione a batteria, serie 700
 Electronic basin tap, powered by battery, 700 series
 Robinet électronique lavabo, alimentation à piles, série 700
 Grifo electrónico lavabo, alimentación a batería, colección 700

I70N2-05000

Con alimentatore da rete 230V
 Powered by mains 230V
 Alimentation sur secteur 230V
 Alimentación de red 230V

1,9 l/min



KTO1LD - P. 271

SU RICHIESTA / ON DEMAND / SUR DEMAND / A PETICIÓN

D1 Nero - Black - Noir - Negro
E1 Bianco - White - Blanche - Blanco
O3 Oro - Gold - Or - Oro
2F Nickel - Nickel - Nickel - Níquel
N3 Rame - Copper - Cuivre - Cobre
R1 Grafite - Graphite - Graphite - Grafito

ART.	FINISHING	PACK.
I70N2-04000	CHROME	1
I70N2-05000	CHROME	1

**02535**Unified Water Label  **6 l/min**

Rubinetto elettronico lavabo, alimentazione a batteria, serie STYLE

Electronic basin tap, powered by battery, STYLE series

Robinet de lavabo électronique, alimentation à piles, série STYLE

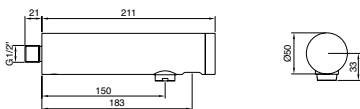
*Grifo electrónico para lavabo, alimentación con batería, colección STYLE***1,9 l/min****KTO1LD - P. 271****SU RICHIESTA / ON DEMAND / SUR DEMAND / A PETICIÓN**

D1 Nero - Black - Noir - Negro
E1 Bianco - White - Blanche - Blanco
O3 Oro - Gold - Or - Oro
2F Nickel - Nickel - Nickel - Níquel
N3 Rame - Copper - Cuivre - Cobre
R1 Grafite - Graphite - Graphite - Grafito

ART.

02535

FINISHING

CHROME

PACK.

1

**O2552/1**

Unified Water Label 6 l/min

Miscelatore elettronico lavello/lavabo a parete con bocca di erogazione girevole 200 mm e alimentazione a batteria serie ONE

Wall mounted electronic basin/sink mixer with swivel spout 200 mm. Powered by battery ONE series

Mitigeur lavabo/évier électronique mural avec bec mobile 200 mm et alimentation à piles série ONE

Mezclador electrónico para lavabo/fregadero con caño giratorio 200 mm. Alimentación con batería colección ONE

1,9 l/min



KTO2LD - P. 271

O2552/1-140

Con bocca di erogazione girevole inferiore 140 mm

With swivel spout 140 mm

Avec bec mobile 140 mm

Con caño giratorio 140 mm

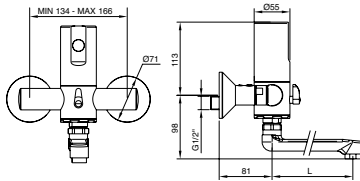

ART.	FINISHING	PACK.
02552/1	CHROME	1
02552/1-140	CHROME	1

**O2550**

Unified Water Label 6 l/min

Rubinetto elettronico lavello/lavabo a parete con bocca di erogazione girevole 200 mm e alimentazione a batteria serie ONE

Wall mounted electronic basin/sink tap with swivel spout 200 mm. Powered by battery ONE series

Robinet de lavabo/évier électronique avec bec mobile 200 mm. Alimentation à piles série ONE

Grifo electrónico para lavabo/fregadero con caño giratorio 200 mm. Alimentación con batería colección ONE

1,9 l/min



KTO2LD - P. 271

O2550-140

Con bocca di erogazione girevole inferiore 140 mm

With swivel spout 140 mm

Avec bec mobile 140 mm

Con caño giratorio 140 mm

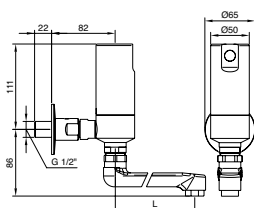

ART.	FINISHING	PACK.
02550	CHROME	1
02550-140	CHROME	1

**908.12**

Miscelatore termostatico temporizzato per lavabo serie 908

Thermostatic self closing basin mixer 908 series

Mitigeur temporisé thermostatique pour lavabo série 908

Mezclador temporizado termostático para lavabo colección 908

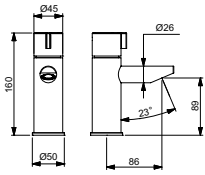
**SU RICHIESTA / ON DEMAND / SUR DEMAND / A PETICIÓN**

- D1** Nero - Black - Noir - Negro
- E1** Bianco - White - Blanche - Blanco
- O3** Oro - Gold - Or - Oro
- 2F** Nickel - Nickel - Nickel - Níquel
- N3** Rame - Copper - Cuivre - Cobre
- R1** Grafite - Graphite - Graphite - Grafito

ART.

908.12

FINISHING

CHROME

PACK.

1



**800.12**Unified
Water Label

6 l/min

Miscelatore temporizzato per lavabo, serie MINIMAL
 Self closing basin mixer, MINIMAL series
 Mitigeur temporisé pour lavabo, série MINIMAL
 Mezclador temporizado para lavabo, colección MINIMAL

1,9 l/min

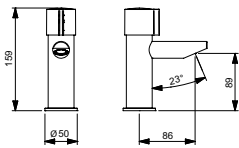

KTO4LD - P. 271

**SU RICHIESTA / ON DEMAND / SUR DEMAND / A PETICIÓN**

D1 Nero - Black - Noir - Negro
E1 Bianco - White - Blanche - Blanco
O3 Oro - Gold - Or - Oro
2F Nickel - Nickel - Nickel - Níquel
N3 Rame - Copper - Cuivre - Cobre
R1 Grafite - Graphite - Graphite - Grafito

ART.	FINISHING	PACK.
800.12	CHROME	1

**800.10**Unified
Water Label

6 l/min

Rubinetto temporizzato per lavabo, serie MINIMAL
 Self closing basin tap, MINIMAL series
 Robinet temporisé lavabo, série MINIMAL
 Grifo temporizado para lavabo, colección MINIMAL

1,9 l/min

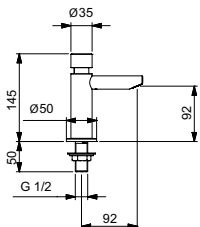

KTO5LD - P. 271

**SU RICHIESTA / ON DEMAND / SUR DEMAND / A PETICIÓN**

D1 Nero - Black - Noir - Negro
E1 Bianco - White - Blanche - Blanco
O3 Oro - Gold - Or - Oro
2F Nickel - Nickel - Nickel - Níquel
N3 Rame - Copper - Cuivre - Cobre
R1 Grafite - Graphite - Graphite - Grafito

ART.	FINISHING	PACK.
800.10	CHROME	1

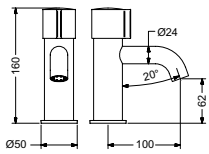
**08112**Unified
Water Label

6 l/min

Miscelatore temporizzato per lavabo, serie MINIMAL
 Self closing basin mixer, MINIMAL series
 Mitigeur temporisé pour lavabo, série MINIMAL
 Mezclador temporizado para lavabo, colección MINIMAL

085112F

Con comando a pulsante antibloccaggio
 With vandal proof push button
 Avec poussoir antiblocage
 Con pulsador anti-bloqueo

1,9 l/min**KTO4LD - P. 271****SU RICHIESTA / ON DEMAND / SUR DEMAND / A PETICIÓN**

D1 Nero - Black - Noir - Negro
E1 Bianco - White - Blanche - Blanco
O3 Oro - Gold - Or - Oro
2F Nickel - Nickel - Nickel - Níquel
N3 Rame - Copper - Cuivre - Cobre
R1 Grafite - Graphite - Graphite - Grafito

ART.	FINISHING	PACK.
08112	CHROME	1
085112F	CHROME	1

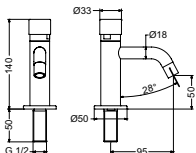
**08111**

Rubinetto temporizzato per lavabo, serie MINIMAL
 Self closing basin tap, MINIMAL series
 Robinet pour lavabo temporisé, série MINIMAL
 Grifo temporizado para lavabo, colección MINIMAL

SU RICHIESTA / ON DEMAND / SUR DEMAND / A PETICIÓN

D1 Nero - Black - Noir - Negro
E1 Bianco - White - Blanche - Blanco
O3 Oro - Gold - Or - Oro
2F Nickel - Nickel - Nickel - Níquel
N3 Rame - Copper - Cuivre - Cobre
R1 Grafite - Graphite - Graphite - Grafito

ART.	FINISHING	PACK.
08111	CHROME	1

**845.12**Unified
Water Label

6 l/min

Miscelatore temporizzato per lavabo, serie 45

Self closing basin mixer, 45 series

Mitigeur temporisé pour lavabo, série 45

Mezclador temporizado para lavabo, colección 45

1,9 l/min

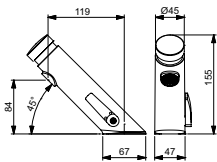

KTO1LD - P. 271

**SU RICHIESTA / ON DEMAND / SUR DEMAND / A PETICIÓN**

- D1** Nero - Black - Noir - Negro
E1 Bianco - White - Blanche - Blanco
O3 Oro - Gold - Or - Oro
2F Nickel - Nickel - Nickel - Níquel
N3 Rame - Copper - Cuivre - Cobre
R1 Grafite - Graphite - Graphite - Grafito

ART.

FINISHING

PACK.

845.12

CHROME

1

**845.10**Unified
Water Label

6 l/min

Rubinetto temporizzato per lavabo, serie 45

Self closing basin tap, 45 series

Robinet pour lavabo temporisé, série 45

Grifo temporizado para lavabo, colección 45

1,9 l/min

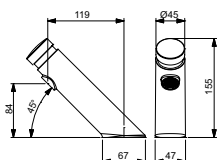

KTO1LD - P. 271

**SU RICHIESTA / ON DEMAND / SUR DEMAND / A PETICIÓN**

- D1** Nero - Black - Noir - Negro
E1 Bianco - White - Blanche - Blanco
O3 Oro - Gold - Or - Oro
2F Nickel - Nickel - Nickel - Níquel
N3 Rame - Copper - Cuivre - Cobre
R1 Grafite - Graphite - Graphite - Grafito

ART.

FINISHING

PACK.

845.10

CHROME

1

**08212**Unified
Water Label

6 l/min

Miscelatore temporizzato per lavabo, serie MODERN

Self closing basin mixer, MODERN series

Mitigeur temporisé pour lavabo, série MODERN

Mezclador temporizado para lavabo, colección MODERN

08512F

Con comando a pulsante antibloccaggio

With vandal proof push button

Avec poussoir antiblocage

Con pulsador anti-bloqueo

08512

Con comando a pulsante antibloccaggio. Tempo regolabile

With vandal proof push button. Adjustable flow time

Avec poussoir antiblocage. Temporisation réglable

Con pulsador anti-bloqueo. Temporización ajustable

1,9 l/min



KTO2LD - P. 271

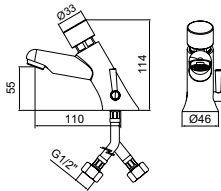

ART.	FINISHING	PACK.
08212	CHROME	1
08512F	CHROME	1
08512	CHROME	1

**08210**Unified
Water Label

6 l/min

Rubinetto temporizzato per lavabo, serie MODERN

Self closing basin tap, MODERN series

Robinet pour lavabo temporisé, série MODERN

Grifo temporizado para lavabo, colección MODERN

08210/PM

Con premiscelatore manuale

With manual pre-mixer

Avec pré-mitigeur manuel

Con pre-mezclador manual

1,9 l/min



KTO2LD - P. 271

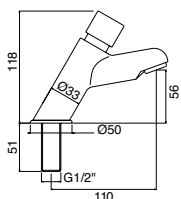

ART.	FINISHING	PACK.
08210	CHROME	1
08210/PM	CHROME	1

**08510**Unified
Water Label

6 l/min

Rubinetto temporizzato per lavabo antibloccaggio. Tempo regolabile, serie MODERN
 Self closing basin tap, vandal proof type. Adjustable flow time, MODERN series
 Robinet temporisé pour lavabo anti-blocage. Temporisation réglable, série MODERN
 Grifo temporizado para lavabo anti-bloqueo. Temporización ajustable, colección MODERN

08510/PM

Con premiscelatore manuale
 With manual pre-mixer
 Avec pré-mitigeur manuel
 Con pre-mezclador manual

08510F

Versione temporizzata 15 sec. non regolabile
 Not adjustable flow time version 15 sec.
 Version avec temporisation 15 sec. pas réglable
 Versión con temporización 15 seg. no ajustable

08510F/PM

Con premiscelatore manuale e tempo non regolabile
 With manual pre-mixer. Not adjustable flow time
 Avec pré-mitigeur manuel. Temporisation pas réglable
 Con pre-mezclador manual. Temporización no ajustable

1,9 l/min



KTO2LD - P. 271

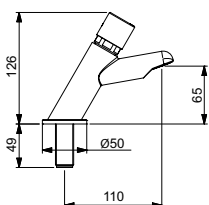

ART.	FINISHING	PACK.
08510	CHROME	1
08510/PM	CHROME	1
08510F	CHROME	1
08510F/PM	CHROME	1

**08012**

Miscelatore temporizzato per lavabo serie CLASSIC

Self closing basin mixer CLASSIC series

Mitigeur temporisé pour lavabo série CLASSIC

Mezclador temporizado para lavabo colección CLASSIC

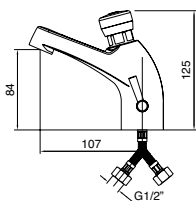
ART.
08012FINISHING
CHROMEPACK.
1

**08250**Unified
Water Label

6 l/min

Rubinetto temporizzato per lavabo serie SMALL
 Self closing basin tap SMALL series
 Robinet pour lavabo temporisé série SMALL
 Grifo temporizado para lavabo colección SMALL

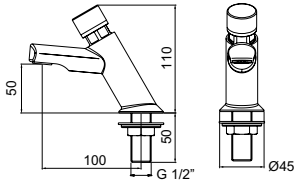

ART.	FINISHING	PACK.
08250	CHROME	1

**08010/E**Unified
Water Label

6 l/min

Rubinetto temporizzato per lavabo serie CLASSIC
 Self closing basin tap CLASSIC series
 Robinet pour lavabo temporisé série CLASSIC
 Grifo temporizado para lavabo colección CLASSIC

08010/EPM

Con premiscelatore manuale
 With manual pre-mixer
 Avec pré-mitigeur manuel
 Con pre-mezclador manual

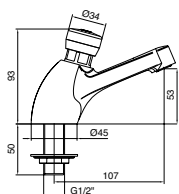

ART.	FINISHING	PACK.
08010/E	CHROME	1
08010/EPM	CHROME	1

**908.35**

Miscelatore termostatico temporizzato per lavabo/lavello con bocca di erogazione girevole 200 mm, serie 908

Thermostatic self closing mixer for basin/sink with swinging spout 200 mm, 908 series

Mitigeur temporisé thermostatique pour lavabo/évier avec bec mobile 200 mm, série 908

Mezclador temporizado termostático para lavabo/fregadero con caño giratorio 200 mm, colección 908

908.35-140

Con bocca di erogazione girevole 140 mm

With swinging spout 140 mm

Avec bec mobile 140 mm

Con caño giratorio 140 mm

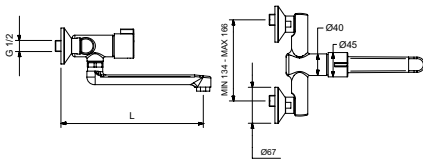

ART.	L	FINISHING	PACK.
908.35	200 MM	CHROME	1
908.35-140	140 MM	CHROME	1



**08135**

Miscelatore temporizzato per lavabo/lavello con bocca di erogazione girevole 200 mm, serie MINIMAL

Self closing mixer for basin/sink with swinging spout 200 mm, MINIMAL series

Mitigeur temporisé pour lavabo/évier avec bec mobile 200 mm, série MINIMAL

Mezclador temporizado para lavabo/fregadero con caño giratorio 200 mm, colección MINIMAL

08135-140

Con bocca di erogazione girevole 140 mm

With swinging spout 140 mm

Avec bec mobile 140 mm

Con caño giratorio 140 mm

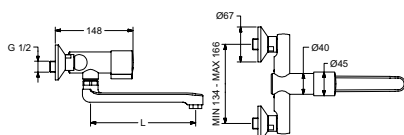
1,9 l/min**KTO2LD - P. 271**

ART.	L	FINISHING	PACK.
08135	200 MM	CHROME	1
08135-140	140 MM	CHROME	1

**08136**

Miscelatore temporizzato per lavabo/lavello con aeratore snodato serie MINIMAL

Self closing mixer for basin/sink with swivel aerator MINIMAL series

Mitigeur temporisé pour lavabo/évier avec aérateur articulé série MINIMAL

Mezclador temporizado para lavabo/fregadero con aireador articulado colección MINIMAL

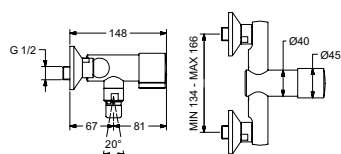

ART.	FINISHING	PACK.
08136	CHROME	1

**800.00**Unified
Water Label

5 l/min

Rubinetto temporizzato per lavabo serie MINIMAL

Self closing basin tap MINIMAL series

Robinet temporisé pour lavabo série MINIMAL

Grifo temporizado para lavabo colección MINIMAL

1,9 l/min

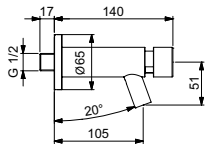

KT05LD - P. 271

**SU RICHIESTA / ON DEMAND / SUR DEMAND / A PETICIÓN**

- D1** Nero - Black - Noir - Negro
- E1** Bianco - White - Blanche - Blanco
- O3** Oro - Gold - Or - Oro
- 2F** Nickel - Nickel - Nickel - Níquel
- N3** Rame - Copper - Cuivre - Cobre
- R1** Grafite - Graphite - Graphite - Grafito

ART.	FINISHING	PACK.
800.00	CHROME	1

**800.00/15**Unified
Water Label

5 l/min

Rubinetto temporizzato per lavabo serie MINIMAL

Self closing basin tap MINIMAL series

Robinet temporisé pour lavabo série MINIMAL

Grifo temporizado para lavabo colección MINIMAL

1,9 l/min

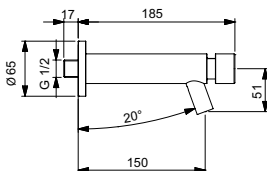

KT05LD - P. 271

**SU RICHIESTA / ON DEMAND / SUR DEMAND / A PETICIÓN**

- D1** Nero - Black - Noir - Negro
- E1** Bianco - White - Blanche - Blanco
- O3** Oro - Gold - Or - Oro
- 2F** Nickel - Nickel - Nickel - Níquel
- N3** Rame - Copper - Cuivre - Cobre
- R1** Grafite - Graphite - Graphite - Grafito

ART.	FINISHING	PACK.
800.00/15	CHROME	1

**08200**

Unified Water Label 6 l/min

Rubinetto temporizzato per lavabo serie MODERN

Self closing basin tap MODERN series

Robinet pour lavabo temporisé série MODERN

Grifo temporizado para lavabo colección MODERN

08500F

Con comando a pulsante antibloccaggio

With vandal proof push button

Avec poussoir antiblocage

Con pulsador anti-bloqueo

1,9 l/min



KT02LD - P. 271

08500

Con comando a pulsante antibloccaggio. Tempo regolabile

With vandal proof push button. Adjustable flow time

Avec poussoir antiblocage. Temporisation réglable

Con pulsador anti-bloqueo. Temporización ajustable

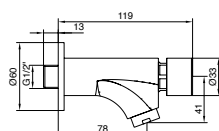

ART.	FINISHING	PACK.
08200	CHROME	1
08500F	CHROME	1
08500	CHROME	1

**08000/E**

Unified Water Label 6 l/min

Rubinetto temporizzato per lavabo serie CLASSIC

Self closing basin tap CLASSIC series

Robinet pour lavabo temporisé série CLASSIC

Grifo temporizado para lavabo colección CLASSIC



O254

1,9 l/min



KT02LD - P. 271

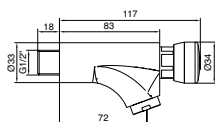

ART.	FINISHING	PACK.
08000/E	CHROME	1
O254	CHROME	1

**08015/E**

Rubinetto temporizzato lavabo/lavello con bocca girevole serie CLASSIC
 Self closing basin/sink tap with swivel spout CLASSIC series
 Robinet de lavabo/évier temporisé avec bec mobile série CLASSIC
 Grifo temporizado para lavabo/fregadero, con caño giratorio colección CLASSIC

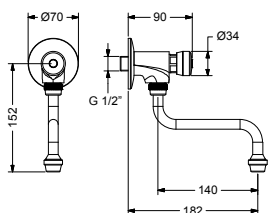

ART.	FINISHING	PACK.
08015/E	CHROME	1

**08140SP**

Rubinetto temporizzato per lavabo da incasso con raccordo di fissaggio per pareti sottili
 Concealed self closing basin tap with fitting for thin walls
 Robinet de lavabo temporisé encastré avec raccord de fixation pour parois fines
 Grifo temporizado empotrado para lavabo con racor de fijación para paredes sutiles

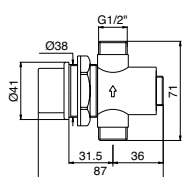

ART.	FINISHING	PACK.
08140SP	CHROME	1

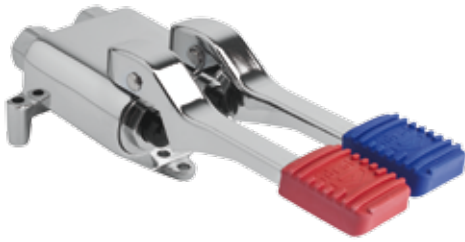
**02066**

Miscelatore a due pedali per installazione a pavimento
Floor mounted double pedal mixer
 Mitigeur à deux pédales pour fixation au sol
 Mezclador con doble pedal para fijación suelo

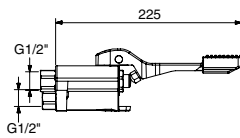

ART.	FINISHING	PACK.
02066	CHROME	1

**02068**

Miscelatore a due pedali per installazione a parete
Wall mounted double pedal mixer
 Mitigeur à deux pédales pour fixation murale
 Mezclador con doble pedal para fijación en pared

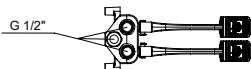
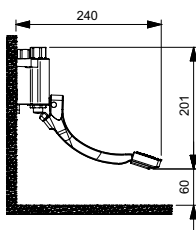

ART.	FINISHING	PACK.
02068	CHROME	1

**02070**

Miscelatore progressivo monopedale per installazione a pavimento
Floor mounted single pedal progressive mixer
 Mitigeur progressif à pédale pour fixation au sol
 Mezclador progresivo monopedal para fijación suelo

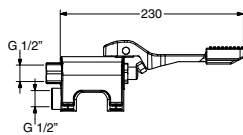

ART.	FINISHING	PACK.
02070	CHROME	1

**02072/90**

Miscelatore progressivo monopedale per installazione a parete
Wall mounted single pedal progressive mixer
 Mitigeur progressif à pédale pour fixation murale
 Mezclador progresivo monopedal para fijación en pared

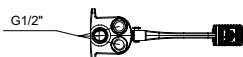
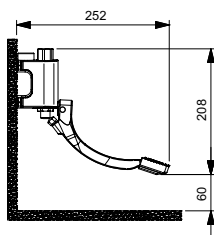

ART.	FINISHING	PACK.
02072/90	CHROME	1

**02061**

Rubinetto a pedale per installazione a pavimento
Floor mounted pedal tap
 Robinet à pédale pour fixation au sol
 Grifo a pedal para fijación suelo

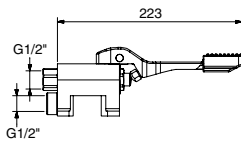

ART.	FINISHING	PACK.
02061	CHROME	1

**02064**

Rubinetto a pedale per installazione a parete
Wall mounted pedal tap
 Robinet à pédale pour fixation murale
 Grifo a pedal para fijación en pared

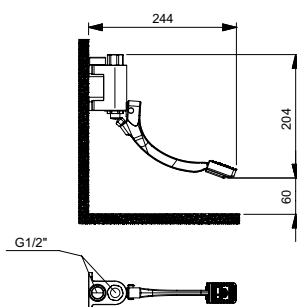

ART.	FINISHING	PACK.
02064	CHROME	1

**02075/01**

Miscelatore progressivo monopedale per installazione a pavimento con dispositivo di bloccaggio dell'erogazione

Floor mounted single pedal progressive mixer with water flow stop device

Mitigeur progressif à pédale pour fixation au sol avec dispositif de blocage de l'écoulement

Mezclador progresivo monopedal con dispositivo de bloqueo de la descarga, para fijación suelo

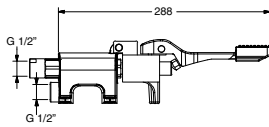

ART.

FINISHING

PACK.

02075/01

CHROME

1

**02115/PR**

Rubinetto istantaneo lavabo da incasso a pavimento, con comando a pulsante

Concealed floor mounted basin tap with push button

Robinet de lavabo encastré au sol, avec poussoir

Grifo para lavabo para fijación empotrada a suelo, con pulsador

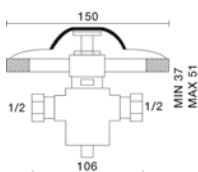

ART.

FINISHING

PACK.

02115/PR

CHROME

1

**KFL61/24**

Kit completo di rubinetto a pedale e bocca di erogazione

Complete kit including pedal tap and spout

Système complet avec robinet à pédale et bec

Conjunto completo con grifo a pedal y caño

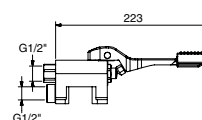
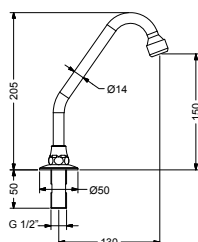
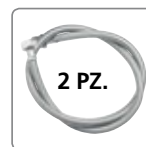

ART.

KFL61/24

FINISHING

CHROME

PACK.

1

**KFL70/26**

Kit completo con miscelatore monopedale e bocca di erogazione

Complete kit including single pedal mixer and spout

Système complet avec mitigeur à pédale et bec

Conjunto completo con mezclador monopedal y caño

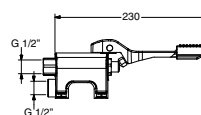
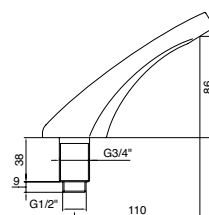
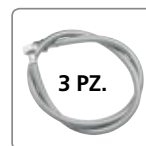

ART.

KFL70/26

FINISHING

CHROME

PACK.

1

**KFL66/25**

Kit completo di miscelatore a due pedali e bocca di erogazione
 Complete kit including double pedal mixer and spout
 Système complet avec mitigeur à deux pédales et bec
 Conjunto completo con mezclador a pedal doble y caño

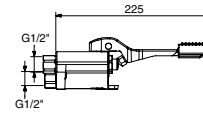
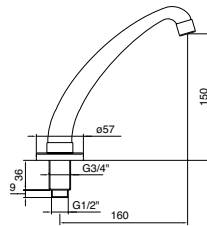

ART.

KFL66/25

FINISHING

CHROME

PACK.

1

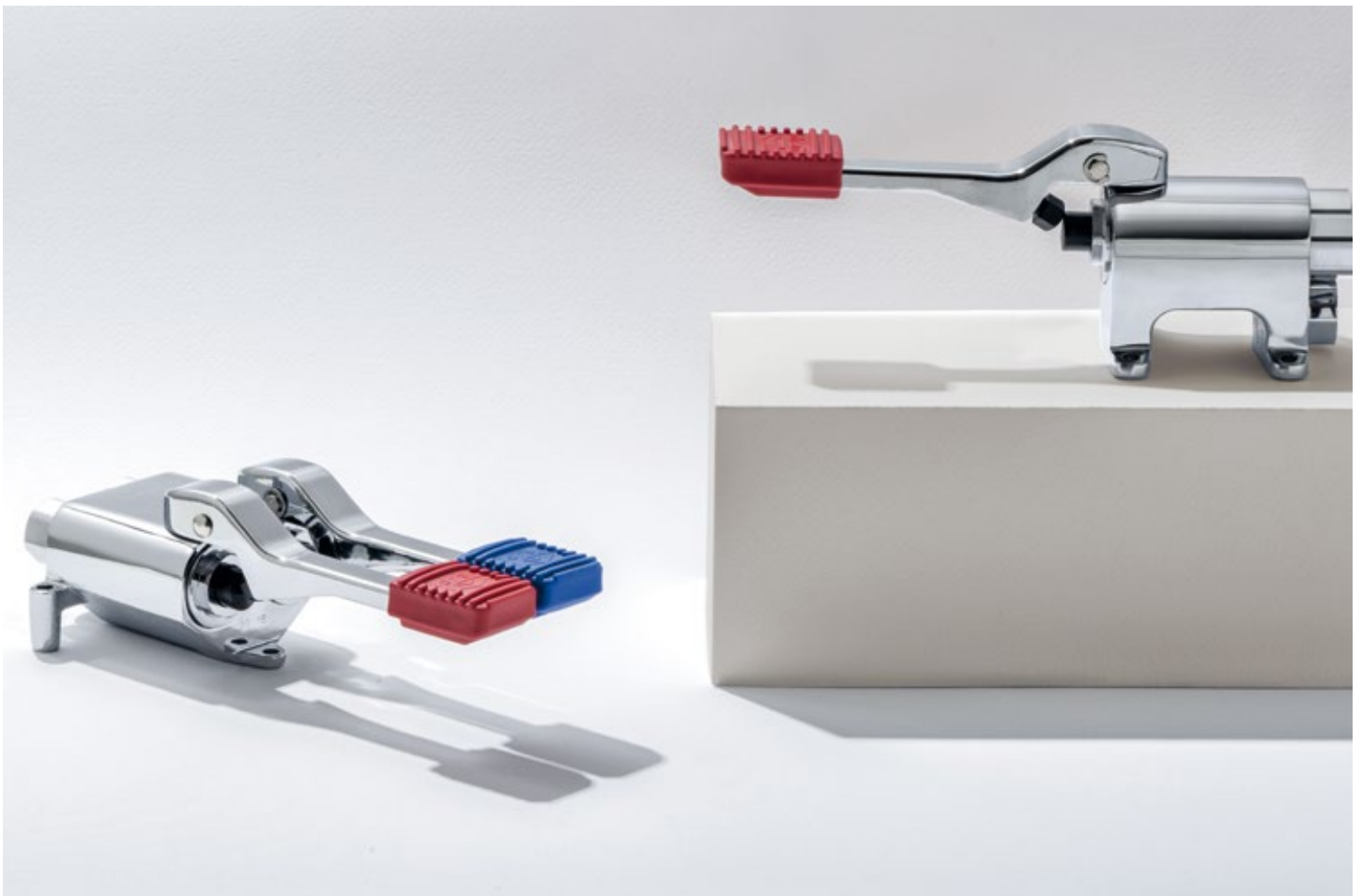

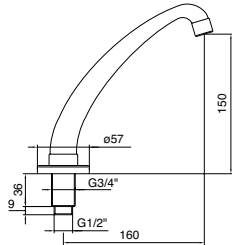
**02025**

Bocca di erogazione girevole per installazione su piano
 Deck mounted swivel spout
 Bec mobile pour installation sur plage
 Caño de descarga giratorio para encimera

ART.	FINISHING	PACK.
02025		1

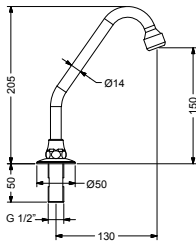
**02024**

Bocca di erogazione girevole per installazione su piano
 Deck mounted swivel spout
 Bec mobile pour installation sur plage
 Caño de descarga giratorio, para encimera

ART.	FINISHING	PACK.
02024		1

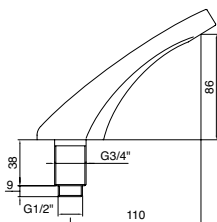
**02026**

Bocca di erogazione fissa per installazione su piano
 Deck mounted fixed spout
 Bec fixe pour installation sur plage
 Caño de descarga fijo para encimera

ART.	FINISHING	PACK.
02026		1

**02130**

Bocca di erogazione fissa a parete
 Wall mounted fixed spout
 Bec fix mural
 Caño fijo de pared

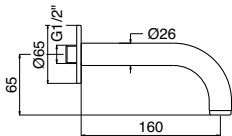

ART.	FINISHING	PACK.
02130		1

**02030**

Bocca di erogazione fissa a parete
 Wall mounted fixed spout
 Bec fix mural
 Caño fijo de pared

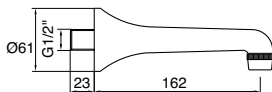

ART.	FINISHING	PACK.
02030		1

**02027**

Bocca di erogazione fissa per installazione su piano con aeratore antivandalo

Deck mounted fixed spout with vandal-proof aerator

Bec fixe pour installation sur plage avec aérateur anti-vandalisme

Caño fijo para encimera con aireador antivandálico

02027/E

Con aeratore standard

With standard aerator

Avec aérateur standard

Con aireador estándar

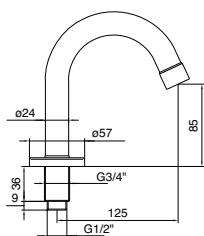

ART.	FINISHING	PACK.
02027	CHROME	1
02027/E	CHROME	1

**09430**

Bocca di erogazione fissa per installazione su piano

Deck mounted fixed spout

Bec fixe pour installation sur plage

Caño fijo para encimera

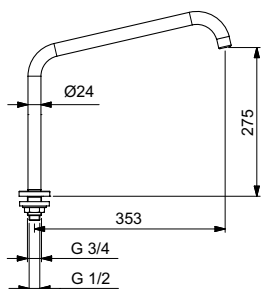

ART.	FINISHING	PACK.
09430	CHROME	1

**02152**

Rubinetto per lavabo minimale
Minimal basin tap
 Robinet de lavabo minimaliste
 Grifo para lavabo minimal

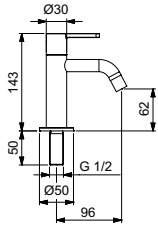
**SU RICHIESTA / ON DEMAND / SUR DEMAND / A PETICIÓN**

D1 Nero - Black - Noir - Negro
E1 Bianco - White - Blanche - Blanco
O3 Oro - Gold - Or - Oro
2F Nickel - Nickel - Nickel - Níquel
N3 Rame - Copper - Cuivre - Cobre
R1 Grafite - Graphite - Graphite - Grafito

ART.

02152

FINISHING

CHROME

PACK.

1

**02102**

Rubinetto per lavabo a parete minimale
Minimal wall mounted basin tap
 Robinet de lavabo mural minimaliste
 Grifo para lavabo de pared minimal

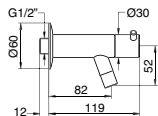
**SU RICHIESTA / ON DEMAND / SUR DEMAND / A PETICIÓN**

D1 Nero - Black - Noir - Negro
E1 Bianco - White - Blanche - Blanco
O3 Oro - Gold - Or - Oro
2F Nickel - Nickel - Nickel - Níquel
N3 Rame - Copper - Cuivre - Cobre
R1 Grafite - Graphite - Graphite - Grafito

ART.

02102

FINISHING

CHROME

PACK.

1

**0153**

Rubinetto lavabo a colonna 1/2", con bocca girevole
 Column basin tap 1/2" with swinging spout
 Robinet de lavabo 1/2" à colonne avec bec mobile
 Grifo lavabo 1/2" a columna con caño giratorio

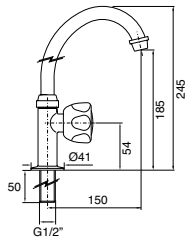

ART.	FINISHING	PACK.
0153	CHROME	1

**0178**

Rubinetto per lavabo 1/2"
 1/2" basin tap
 Robinet de lavabo 1/2"
 Grifo lavabo 1/2"

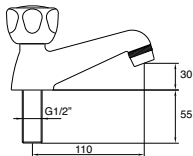

ART.	FINISHING	PACK.
0178	CHROME	1

**0159/86**

Miscelatore a parete per lavello con canna girevole inferiore
 Wall mounted sink mixer with lower swivel spout
 Mitigeur mural pour évier avec bec mobile inférieur
 Mezclador de pared para fregadero, con caño giratorio inferior

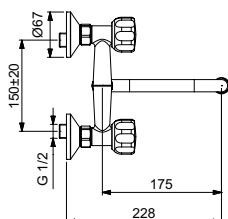

ART.	FINISHING	PACK.
0159/86	CHROME	1

**0150/DC**

Rubinetto portagomma a parete cromato con comando a leva corta

Wall mounted chromed hose fitting tap with short lever

Robinet porte-tuyau mural chromé avec commande à manette courte

Grifo portamanguera de pared cromado con mando de palanca corta

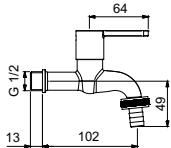

ART.	FINISHING	PACK.
0150/DC	CHROME	1

**0160M12**

Rubinetto a parete cromato con comando a maniglia

Wall mounted chromed tap with handle

Robinet mural chromé avec poignée

Grifo de pared cromado con pomo

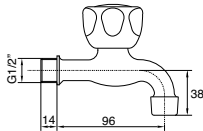

ART.	FINISHING	PACK.
0160M12	CHROME	1

**0161M12**

Rubinetto prolungato a parete cromato con comando a maniglia

Wall mounted extended chromed tap with handle

Robinet prolongé mural chromé avec poignée

Grifo prolongado de pared cromado con pomo

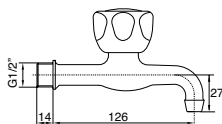

ART.	FINISHING	PACK.
0161M12	CHROME	1

**0162M12**

Rubinetto a snodo a parete cromato con comando a maniglia

Wall mounted tap with swinging spout and handle

Robinet articulé mural chromé à commande à bouton

Grifo articulado de pared cromado con manija

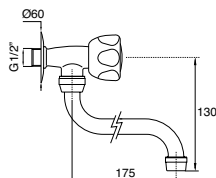

ART.	FINISHING	PACK.
0162M12	CHROME	1

**0163M12**

Rubinetto portagomma a parete cromato con comando a maniglia

Wall mounted chromed hose fitting tap with handle

Robinet porte-tuyau mural chromé avec poignée

Grifo portamanguera de pared cromado con pomo

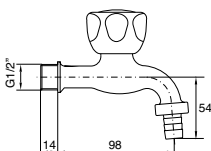

ART.	FINISHING	PACK.
0163M12	CHROME	1







900.12

Miscelatore termostatico progressivo per lavabo con leva clinica serie 900

Thermostatic progressive basin mixer with clinical lever 900 series

Mitigeur thermostatique progressif pour lavabo avec manette clinique série 900

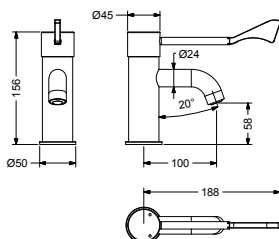
Mezclador termostático progresivo para lavabo con palanca medical colección 900

SU RICHIESTA / ON DEMAND / SUR DEMAND / A PETICIÓN

T1 Rivestimento ANTIBATTERICO su richiesta
 Antibacterial coating on demand
 Finition antibactérienne sur demande
 Acabado antibacteriano a petición

ART.

FINISHING

PACK.

900.12

CHROME

1



900.25

Miscelatore termostatico progressivo per lavabo con leva clinica serie 900

Thermostatic progressive basin mixer with clinical lever 900 series

Mitigeur thermostatique progressif pour lavabo avec manette clinique série 900

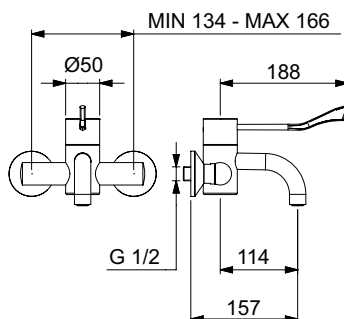
Mezclador termostático progresivo para lavabo con palanca medical colección 900

SU RICHIESTA / ON DEMAND / SUR DEMAND / A PETICIÓN

T1 Rivestimento ANTIBATTERICO su richiesta
 Antibacterial coating on demand
 Finition antibactérienne sur demande
 Acabado antibacteriano a petición

ART.

FINISHING

PACK.

900.25

CHROME

1

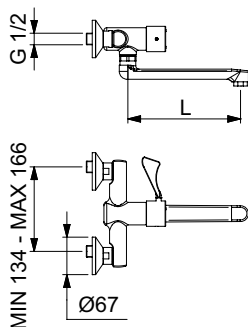
900.35

Miscelatore termostatico progressivo per lavabo/lavello con leva clinica e canna girevole serie 900

Thermostatic progressive mixer for basin/sink with clinical lever and swinging spout 900 series

Mitigeur thermostatique progressif pour lavabo/évier avec manette clinique et bec mobile série 900

Mezclador termostático progresivo para lavabo/fregadero con palanca medical y caño giratorio colección 900

900.35-140

Con bocca di erogazione girevole 140 mm

With swinging spout 140 mm

Avec bec mobile 140 mm

Con caño giratorio 140 mm

SU RICHIESTA / ON DEMAND / SUR DEMAND / A PETICIÓN

T1 Rivestimento ANTIBATTERICO su richiesta
 Antibacterial coating on demand
 Finition antibactérienne sur demande
 Acabado antibacteriano a petición

ART.

FINISHING

PACK.

900.35

CHROME

1

900.35-140

CHROME

1

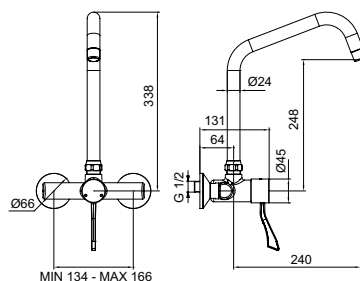
900.39-240

Miscelatore termostatico progressivo per lavabo/lavello con leva clinica e canna girevole serie 900

Thermostatic progressive mixer for basin/sink with clinical lever and swinging spout 900 series

Mitigeur thermostatique progressif pour lavabo/évier avec manette clinique et bec mobile série 900

Mezclador termostático progresivo para lavabo/fregadero con palanca medical y caño giratorio colección 900

SU RICHIESTA / ON DEMAND / SUR DEMAND / A PETICIÓN

T1 Rivestimento ANTIBATTERICO su richiesta
 Antibacterial coating on demand
 Finition antibactérienne sur demande
 Acabado antibacteriano a petición

ART.

FINISHING

PACK.

900.39-240

CHROME

1

02058

Miscelatore progressivo per lavabo con leva clinica

Progressive basin mixer, with clinical lever

Mitigeur progressif lavabo avec manette clinique

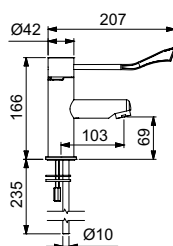
Mezclador progresivo lavabo con palanca medical

SU RICHIESTA / ON DEMAND / SUR DEMAND / A PETICIÓN

T1 Rivestimento ANTIBATTERICO su richiesta
Antibacterial coating on demand
 Finition antibactérienne sur demande
Acabado antibacteriano a petición

ART.

FINISHING

PACK.

02058

CHROME

1

02058/1

Miscelatore progressivo per lavabo con leva clinica e prolunga

Progressive basin mixer, with clinical lever and extension

Mitigeur progressif lavabo avec manette clinique et rallonge

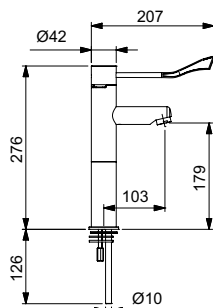
Mezclador progresivo lavabo con palanca medical y prolongador

SU RICHIESTA / ON DEMAND / SUR DEMAND / A PETICIÓN

T1 Rivestimento ANTIBATTERICO su richiesta
Antibacterial coating on demand
 Finition antibactérienne sur demande
Acabado antibacteriano a petición

ART.

FINISHING

PACK.

02058/1

CHROME

1

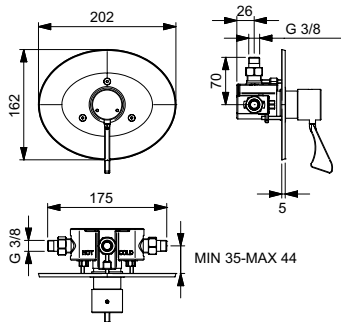
900.42

Miscelatore termostatico progressivo per doccia da incasso con leva clinica serie 900
 Thermostatic progressive concealed mixer for shower with clinical lever 900 series
 Mitigeur thermostatique progressif pour douche encastré avec manette clinique série 900
 Mezclador termostático progresivo para ducha empotrado con palanca medical colección 900

M90H4-00000

Con sistema anti-ristagno
 With anti-stagnation system
 Avec système anti-stagnation
 Con sistema anti-estancamiento

SU RICHIESTA / ON DEMAND / SUR DEMAND / A PETICIÓN

T1 Rivestimento ANTIBATTERICO su richiesta
 Antibacterial coating on demand
 Finition antibactérienne sur demande
 Acabado antibacteriano a petición

ART.	FINISHING	PACK.
900.42	CHROME	1
M90H4-00000	CHROME	1

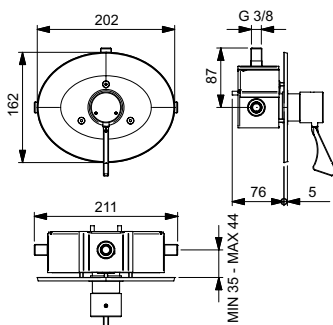
900.42/1

Miscelatore termostatico progressivo per doccia da incasso con leva clinica con scatola di protezione serie 900
 Thermostatic progressive concealed mixer for shower with clinical lever and protection case 900 series
 Mitigeur thermostatique progressif pour douche encastré avec manette clinique et boîte de protection série 900
 Mezclador termostático progresivo ducha empotrado con palanca medical y caja de protección colección 900

M90H4-01000

Con sistema anti-ristagno
 With anti-stagnation system
 Avec système anti-stagnation
 Con sistema anti-estancamiento

SU RICHIESTA / ON DEMAND / SUR DEMAND / A PETICIÓN

T1 Rivestimento ANTIBATTERICO su richiesta
 Antibacterial coating on demand
 Finition antibactérienne sur demande
 Acabado antibacteriano a petición

ART.	FINISHING	PACK.
900.42/1	CHROME	1
M90H4-01000	CHROME	1

900.32

Miscelatore termostatico progressivo per doccia con leva clinica serie 900

Thermostatic progressive mixer for shower with clinical lever 900 series

Mitigeur thermostatique progressif pour douche avec manette clinique série 900

Mezclador termostático progresivo para ducha con palanca medical colección 900

900.37

Con presa acqua inferiore

With water inlet below

Avec connexion de l'eau par dessous

Con conexión para el agua desde abajo

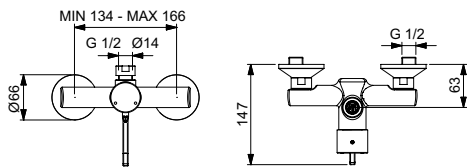
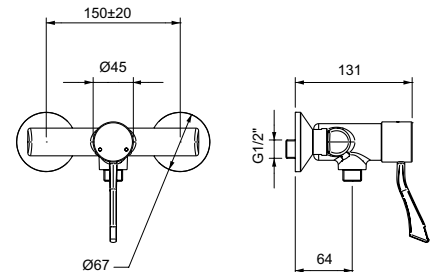
SU RICHIESTA / ON DEMAND / SUR DEMAND / A PETICIÓN

T1 Rivestimento ANTIBATTERICO su richiesta
 Antibacterial coating on demand
 Finition antibactérienne sur demande
 Acabado antibacteriano a petición

ART.

FINISHING

PACK.

 900.32
 900.37

 CHROME
 CHROME

 1
 1



L90H3-00000

Pannello doccia in acciaio inox con miscelatore termostatico progressivo a leva clinica serie 900

Shower panel in stainless steel with thermostatic progressive lever mixer 900 series

Panneau de douche en acier inox avec mitigeur thermostatique progressif à manette clinique série 900

Panel de ducha en acero inox con mezclador temostático progresivo con palanca medical colección 900

M90H3-00000

Pannello doccia temporizzato in acciaio inox con miscelatore termostatico progressivo serie 900

Self closing shower panel in stainless steel with thermostatic progressive mixer 900 series

Panneau de douche temporisé en acier inox avec mitigeur thermostatique progressif série 900

Panel de ducha temporizado en acero inox con mezclador temostático progresivo colección 900

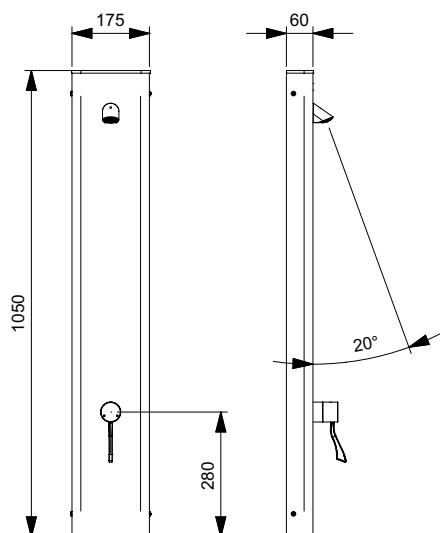

ART.	FINISHING	PACK.
L90H3-00000	INOX	1
M90H3-00000	INOX	1



08013A

Miscelatore temporizzato lavabo con comando a leva antivandalico serie CLASSIC

Self closing basin mixer with vandal proof lever CLASSIC series

Mitigeur temporisé lavabo avec manette anti-vandalisme série CLASSIC

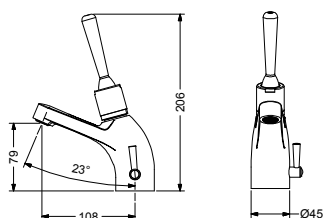
Mezclador temporizado lavabo con palanca antivandálica colección CLASSIC



ART.	FINISHING	PACK.
08013A	CHROME	1

08011A

Rubinetto temporizzato lavabo con comando a leva antivandalico serie CLASSIC

Self closing basin tap with vandal proof lever CLASSIC series

Robinet de lavabo temporisé avec manette anti-vandalisme série CLASSIC

Grifo temporizado lavabo con palanca antivandálica colección CLASSIC

08011A/PM

Con premiscelatore manuale

With manual pre-mixer

Avec pré-mitigeur manuel

Con pre-mezclador manual

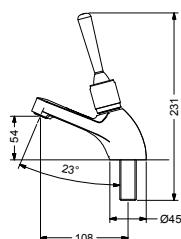

ART.	FINISHING	PACK.
08011A	CHROME	1
08011A/PM	CHROME	1

08001A

 Unified
Water Label

6 l/min

Rubinetto temporizzato lavabo a parete con comando a leva antivandalico serie CLASSIC
 Wall mounted self closing basin tap with vandal proof lever CLASSIC series
 Robinet de lavabo mural temporisé avec manette anti-vandalisme série CLASSIC
 Grifo temporizado lavabo de pared con palanca antivandálica colección CLASSIC

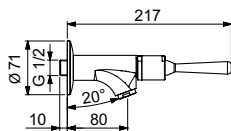

ART.	FINISHING	PACK.
08001A	CHROME	1

08016A

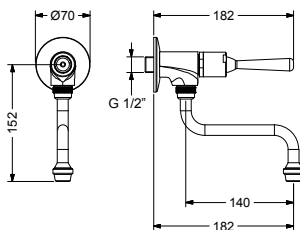

Rubinetto temporizzato lavabo/lavello a parete con comando a leva antivandalico e bocca girevole serie CLASSIC
 Wall mounted self closing basin/sink tap with vandal proof lever and swivel spout CLASSIC series
 Robinet de lavabo/évier mural temporisé avec manette anti-vandalisme et bec mobile série CLASSIC
 Grifo temporizado lavabo/fregadero de pared con palanca antivandálica y caño de descarga giratorio colección CLASSIC

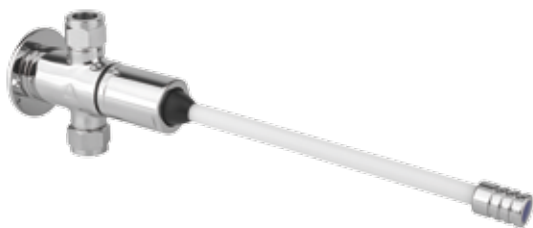

ART.	FINISHING	PACK.
08016A	CHROME	1

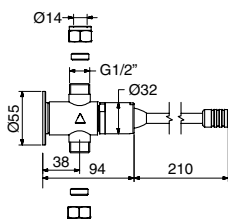

08145A

Rubinetto temporizzato lavabo con comando a leva a ginocchio, antivandalico serie CLASSIC
 Wall mounted self closing basin tap with knee operated vandal proof lever CLASSIC series
 Robinet de lavabo mural temporisé avec manette anti-vandalisme à commande fémorale série CLASSIC
 Grifo temporizado lavabo de pared con palanca de rodilla antivandálica colección CLASSIC



ART.	FINISHING	PACK.
08145A	CHROME	1

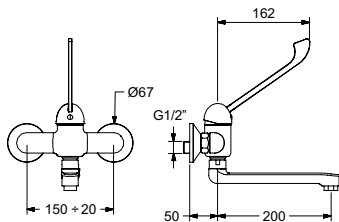

02400

Miscelatore monocomando a parete per lavello con leva clinica
 Wall mounted single clinical lever sink mixer
 Mitigeur monocommande mural pour évier avec manette clinique
 Mezclador monomando de pared para fregadero, con palanca medical

ART.	FINISHING	PACK.
02400	CHROME	1

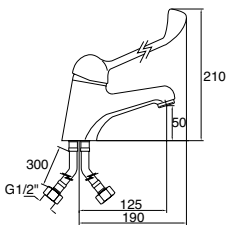

02475

Miscelatore monocomando per lavabo con leva clinica
 Single clinical lever mixer for basin
 Mitigeur monocommande pour lavabo avec manette clinique
 Mezclador monomando para lavabo, con palanca medical

02475/LN

Con leva corta
 Short lever operated
 Avec manette courte
 Con palanca corta

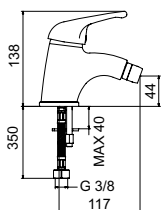
ART.	FINISHING	PACK.
02475	CHROME	1
02475/LN	CHROME	

02477

Miscelatore monocomando per bidet
 Single lever mixer for bidet
 Mitigeur monocommande pour bidet
 Mezclador monomando para bidet

ART.	FINISHING	PACK.
02477	CHROME	1

02450

Miscelatore monocomando per cucina con leva clinica e canna girevole

Single clinical lever kitchen mixer with swivel spout

Mitigeur monocommande pour cuisine avec manette clinique et bec mobile

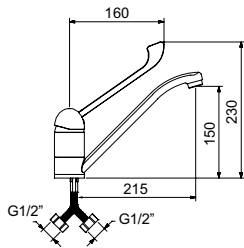
Mezclador monomando para cocina con caño de descarga giratorio y palanca medical

ART.	FINISHING	PACK.
02450	CHROME	1

02451

Miscelatore monocomando per cucina con doccetta estraibile e leva clinica

Single clinical lever kitchen mixer with pull-out hand shower

Mitigeur monocommande pour cuisine avec douchette extractible et manette clinique

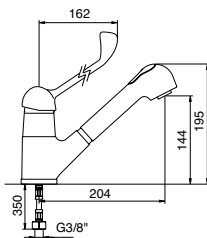
Mezclador monomando para cocina con teleducha extraíble y palanca medical

ART.	FINISHING	PACK.
02451	CHROME	1

02150

Rubinetto per lavabo con leva clinica

Clinical lever basin tap

Robinet de lavabo avec manette clinique

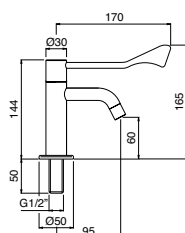
Grifo para lavabo con palanca medical

ART.	FINISHING	PACK.
02150	CHROME	1

02050/DC

Rubinetto per lavabo con leva clinica
Clinical lever basin tap
 Robinet de lavabo avec manette clinique
Grifo para lavabo con palanca medical

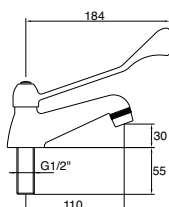

ART.	FINISHING	PACK.
02050/DC	CHROME	1

02001/DC

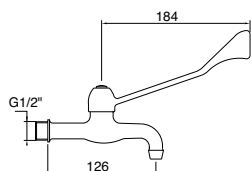

Rubinetto prolungato per lavabo con leva clinica
Extended lever basin tap
 Robinet prolongé de lavabo avec manette clinique
Grifo para lavabo con palanca medical



ART.	FINISHING	PACK.
02001/DC	CHROME	1

02010/DC

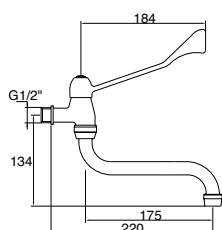
Rubinetto rovesciato per lavabo a parete con leva clinica
Wall mounted clinical lever basin tap
 Robinet inversé mural pour lavabo avec manette clinique
Grifo volcado para lavabo de pared con palanca medical



ART.	FINISHING	PACK.
02010/DC	CHROME	1





Sistema di funzionamento

Operating system - Mode de fonctionnement - Sistema de funcionamiento

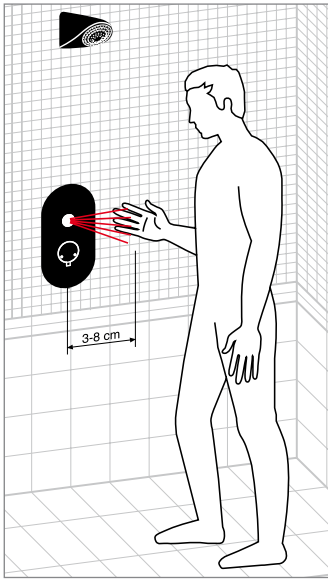
**1A**

Avvicinando la mano al sensore
(distanza tra 3-8 cm)
Approaching the hand to the sensor
(distance 3-8 cm)
En plaçant la main à 3-8 cm du
capteur

Acercando la mano al sensor
(distancia entre 3 y 8 cm)

**2A**

Inizia l'erogazione d'acqua
The water flow starts
L'écoulement de l'eau commence
Empieza la descarga del agua

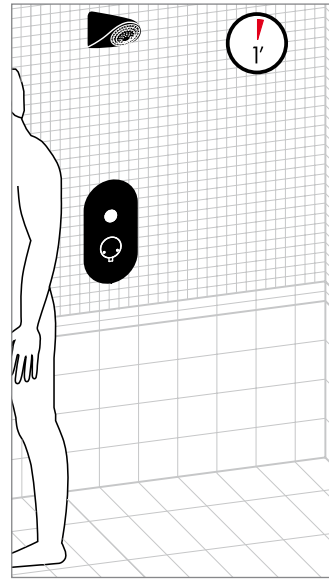
**3A**

Trascorso 1 minuto di tempo l'acqua
si arresta automaticamente
After 1 minute, the water flow stops
automatically

Après 1 minute l'écoulement de
l'eau s'arrête automatiquement
Después de 1 minuto de tiempo,
la descarga de agua se para
automaticamente

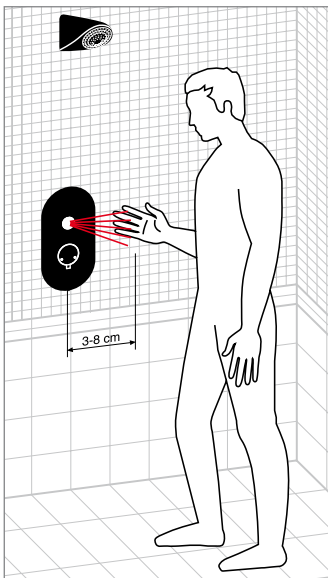
**1B**

Avvicinando la mano al sensore
(distanza tra 3-8 cm)
Approaching the hand to the
sensor (distance 3-8 cm)
En plaçant la main à 3-8 cm
du capteur

Acercando la mano al sensor
(distancia entre 3 y 8 cm)

**2B**

Inizia l'erogazione d'acqua
The water flow starts
L'écoulement de l'eau commence
Empieza la descarga del agua

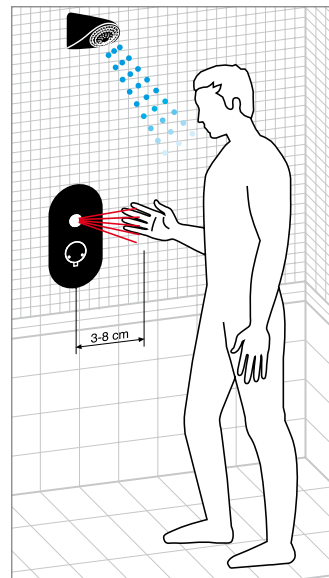
**3B**

Avvicinando nuovamente la mano
al sensore
Approaching again the hand to the
sensor

En plaçant la main encore en face
au capteur
Volviendo a acercar la mano al
sensor

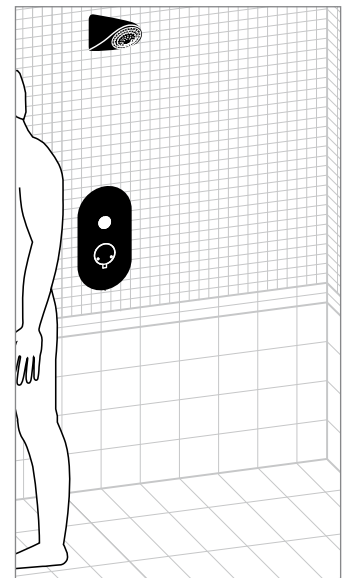
**4B**

L'erogazione d'acqua termina
The water flow stops
L'écoulement de l'eau s'arrête
La descarga de agua se para

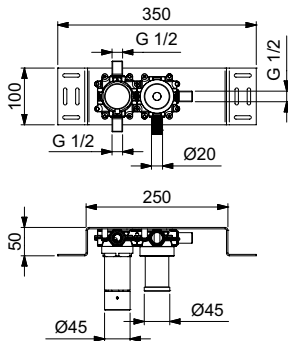

I70M4-00000



Miscelatore elettronico da incasso per doccia, con alimentatore a batteria, serie 700
 Electronic concealed shower mixer, powered by battery, 700 series
 Mitigeur électronique encastré pour douche, alimentation à piles, série 700
 Mezclador electrónico para ducha fijación empotrada, alimentación a batería, colección 700

I70M4-01000



Con alimentatore da rete 230V
 Powered by mains 230V
 Alimentation sur secteur 230V
 Alimentación de red 230V

SU RICHIESTA / ON DEMAND / SUR DEMAND / A PETICIÓN

- D1** Nero - Black - Noir - Negro
- E1** Bianco - White - Blanche - Blanco
- O3** Oro - Gold - Or - Oro
- 2F** Nickel - Nickel - Nickel - Níquel
- N3** Rame - Copper - Cuivre - Cobre
- R1** Grafite - Graphite - Graphite - Grafito

ART.	FINISHING	PACK.
I70M4-00000	CHROME	1
I70M4-01000	CHROME	1

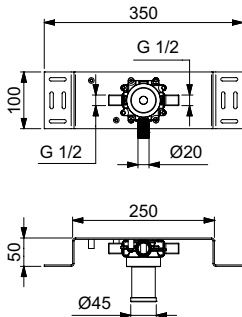

I70N4-00000



Rubinetto elettronico da incasso per doccia, con alimentatore a batteria, serie 700
 Electronic concealed shower tap, powered by battery, 700 series
 Robinet électronique encastré pour douche, alimentation à piles, série 700
 Grifo electrónico para ducha empotrado, alimentación a batería, colección 700

I70N4-01000



Con alimentatore da rete 230V
 Powered by mains 230V
 Alimentation sur secteur 230V
 Alimentación de red 230V

SU RICHIESTA / ON DEMAND / SUR DEMAND / A PETICIÓN

- D1** Nero - Black - Noir - Negro
- E1** Bianco - White - Blanche - Blanco
- O3** Oro - Gold - Or - Oro
- 2F** Nickel - Nickel - Nickel - Níquel
- N3** Rame - Copper - Cuivre - Cobre
- R1** Grafite - Graphite - Graphite - Grafito

ART.	FINISHING	PACK.
I70N4-00000	CHROME	1
I70N4-01000	CHROME	1

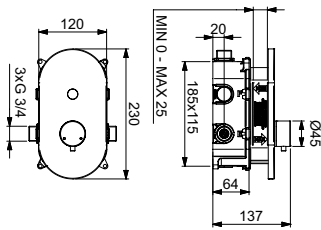
**700.A3/1**

Unified Water Label 8 l/min

Miscelatore termostatico elettronico per doccia da incasso, alimentazione a batteria, serie 700
 Concealed electronic thermostatic shower mixer, battery operated, 700 series

Mitigeur thermostatique électronique encastré pour douche avec alimentation à piles, série 700

Mezclador termostático electrónico para ducha fijación empotrada y alimentación con batería, colección 700

700.A3/1R

Con alimentatore da rete 230V

Powered by mains 230V

Alimentation sur secteur 230V

Alimentación de red 230V

ART.	FINISHING	PACK.
700.A3/1	CHROME	1
700.A3/1R	CHROME	1

SU RICHIESTA / ON DEMAND / SUR DEMAND / A PETICIÓN

- D1** Nero - Black - Noir - Negro
E1 Bianco - White - Blanche - Blanco
O3 Oro - Gold - Or - Oro
2F Nickel - Nickel - Nickel - Níquel
N3 Rame - Copper - Cuivre - Cobre
R1 Grafite - Graphite - Graphite - Grafito

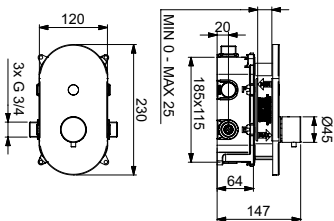
**700.A4/1**

Miscelatore elettronico doccia da incasso. Alimentazione a batteria serie 700

Concealed electronic shower mixer battery operated 700 series

Mitigeur de douche électronique encastré. Alimentation à piles série 700

Mezclador electrónico para ducha fijación empotrada y alimentación con batería colección 700

700.A4/1R

Con alimentatore da rete 230V

Powered by mains 230V

Alimentation sur secteur 230V

Alimentación de red 230V

ART.	FINISHING	PACK.
700.A4/1	CHROME	1
700.A4/1R	CHROME	1

SU RICHIESTA / ON DEMAND / SUR DEMAND / A PETICIÓN

- D1** Nero - Black - Noir - Negro
E1 Bianco - White - Blanche - Blanco
O3 Oro - Gold - Or - Oro
2F Nickel - Nickel - Nickel - Níquel
N3 Rame - Copper - Cuivre - Cobre
R1 Grafite - Graphite - Graphite - Grafito

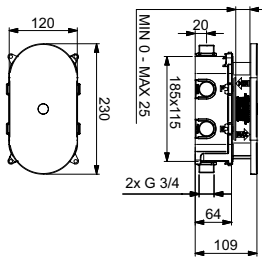

700.A5/1



Unified Water Label

8 l/min

Rubinetto elettronico per doccia da incasso con alimentazione a batteria, serie 700

Concealed electronic shower tap, battery operated, 700 series

Robinet de douche électronique encastré avec alimentation à piles, série 700

Grifo electrónico para ducha fijación empotrada y alimentación con batería, colección 700

700.A5/1R



Con alimentatore da rete 230V

Powered by mains 230V

Alimentation sur secteur 230V

Alimentación de red 230V

SU RICHIESTA / ON DEMAND / SUR DEMAND / A PETICIÓN

- D1** Nero - Black - Noir - Negro
- E1** Bianco - White - Blanche - Blanco
- O3** Oro - Gold - Or - Oro
- 2F** Nickel - Nickel - Nickel - Níquel
- N3** Rame - Copper - Cuivre - Cobre
- R1** Grafite - Graphite - Graphite - Grafito

ART.	FINISHING	PACK.
700.A5/1	CHROME	1
700.A5/1R	CHROME	1



**700.A2/1**

Miscelatore temporizzato per doccia da incasso con deviatore serie 700

Concealed self closing shower mixer with diverter 700 series

Mitigeur temporisé douche encastré avec déviateur série 700

Mezclador temporizado para ducha fijación empotrada con desviador colección 700

700.A2/1-30

Temporizzato a 25 sec.

Timing 25 sec.

Temporisé 25 sec.

Temporizado 25 seg.

700.A2/1F

Con pulsante antibloccaggio. Temporizzato 15 sec.

With vandal push button. Timing 15 sec.

Avec poussoir anti-blocage. Temp. 15 sec.

Con pulsador anti-bloqueo. Temp. 15 seg.

700.A2/1F-30

Con pulsante antibloccaggio. Temporizzato 25 sec.

With vandal push button. Timing 25 sec.

Avec poussoir anti-blocage. Temp. 25 sec.

Con pulsador anti-bloqueo. Temp. 25 seg.

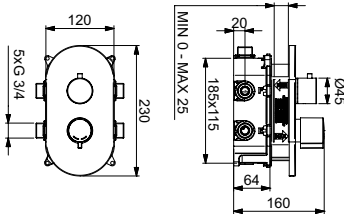
**SU RICHIESTA / ON DEMAND / SUR DEMAND / A PETICIÓN**

D1 Nero - Black - Noir - Negro
E1 Bianco - White - Blanche - Blanco
O3 Oro - Gold - Or - Oro
2F Nickel - Nickel - Nickel - Níquel
N3 Rame - Copper - Cuivre - Cobre
R1 Grafite - Graphite - Graphite - Grafito

ART.	FINISHING	PACK.
700.A2/1	CHROME	1
700.A2/1-30	CHROME	1
700.A2/1F	CHROME	1
700.A2/1F-30	CHROME	1



700.A1/1



Miscelatore termostatico temporizzato per doccia da incasso con deviatore serie 700
 Thermostatic self-closing concealed mixer for shower with diverter 700 series
 Mitigeur thermostatique temporisé pour douche encastré avec déviateur série 700
 Mezclador termostático temporizado para ducha empotrado con desviador colección 700

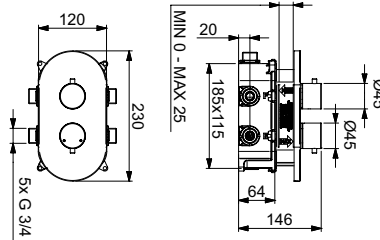

SU RICHIESTA / ON DEMAND / SUR DEMAND / A PETICIÓN

- D1** Nero - Black - Noir - Negro
- E1** Bianco - White - Blanche - Blanco
- O3** Oro - Gold - Or - Oro
- 2F** Nickel - Nickel - Nickel - Níquel
- N3** Rame - Copper - Cuivre - Cobre
- R1** Grafite - Graphite - Graphite - Grafito

ART.	FINISHING	PACK.
700.A1/1	CHROME	1



02605



Gettoniera singola per comando doccia
 Single coin box for shower control
 Monnayeur minuteur pour douche
 Cajetín individual para mando ducha

02606

Gettone per gettoniera doccia 02605
 Coin for shower coin box 02605
 Jeton pour monnayeur douche art. 02605
 Ficha para cajetín ducha art. 02605

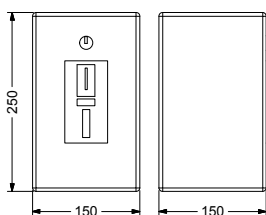

ART.	FINISHING	PACK.
02605		1
02606		100

**I90H3-00000**

Pannello doccia inox AISI304 con miscelatore termostatico, alimentazione a batteria
 Shower panel in stainless steel AISI304 with thermostatic electronic mixer, powered by battery

Panneau de douche mural en acier inox AISI304 avec mitigeur thermostatique électronique, alimentation à piles

Panel de ducha en acero inox AISI304 con mezclador termostático electrónico, alimentación a batería

I90H3-01000

Con alimentatore da rete 230V

Powered by mains 230V

Alimentation sur secteur 230V

Alimentación de red 230V

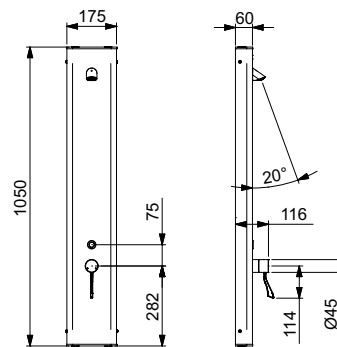

ART.	FINISHING	PACK.
I90H3-00000	INOX	1
I90H3-01000	INOX	1



908.32



Miscelatore termostatico temporizzato per doccia serie 908
 Thermostatic self closing mixer for shower 908 series
 Mitigeur thermostatique temporisé pour douche série 908
 Mezclador termostático temporizado ducha colección 908

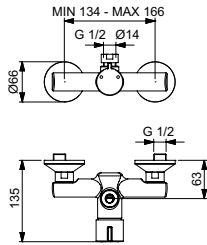

ART.	FINISHING	PACK.
908.32	CHROME	1



908.37



Miscelatore termostatico per doccia temporizzato serie 908
 Thermostatic self closing mixer for shower 908 series
 Mitigeur thermostatique temporisé pour douche série 908
 Mezclador termostático temporizado para ducha colección 908

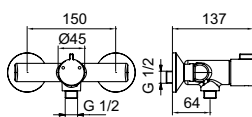

ART.	FINISHING	PACK.
908.37	CHROME	1

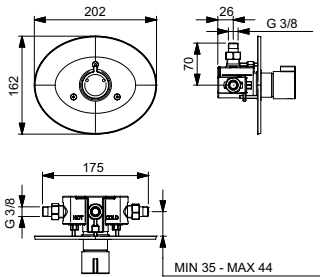

908.42



Miscelatore termostatico temporizzato per doccia da incasso serie 908

Thermostatic self closing concealed mixer for shower 908 series

Mitigeur thermostatique temporisé pour douche encastré série 908

Mezclador termostático temporizado para ducha fijación empotrada colección 908

T98H4-00000

Con sistema anti-ristagno

With anti-stagnation system

Avec système anti-stagnation

Con sistema anti-estancamiento

SU RICHIESTA / ON DEMAND / SUR DEMAND / A PETICIÓN

- D1** Nero - Black - Noir - Negro
- E1** Bianco - White - Blanche - Blanco
- O3** Oro - Gold - Or - Oro
- 2F** Nickel - Nickel - Nickel - Níquel
- N3** Rame - Copper - Cuivre - Cobre
- R1** Grafite - Graphite - Graphite - Grafito

ART.	FINISHING	PACK.
908.42	CHROME	1
T98H4-00000	CHROME	1

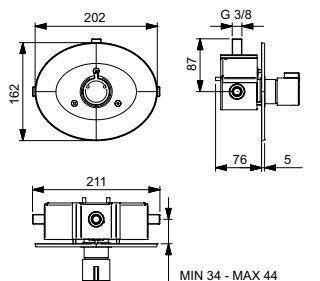

908.42/1



Miscelatore termostatico temporizzato per doccia da incasso con scatola di protezione serie 908

Thermostatic self closing concealed mixer for shower with protection case 908 series

Mitigeur thermostatique temporisé pour douche encastré avec boîte de protection série 908

Mezclador termostático temporizado para ducha fijación empotrada con caja de protección colección 908

T98H4-01000

Con sistema anti-ristagno

With anti-stagnation system

Avec système anti-stagnation

Con sistema anti-estancamiento

SU RICHIESTA / ON DEMAND / SUR DEMAND / A PETICIÓN

- D1** Nero - Black - Noir - Negro
- E1** Bianco - White - Blanche - Blanco
- O3** Oro - Gold - Or - Oro
- 2F** Nickel - Nickel - Nickel - Níquel
- N3** Rame - Copper - Cuivre - Cobre
- R1** Grafite - Graphite - Graphite - Grafito

ART.	FINISHING	PACK.
908.42/1	CHROME	1
T98H4-01000	CHROME	1

**08133**

Miscelatore temporizzato doccia con alimentazione esterna serie MINIMAL

Self closing shower mixer with external water supply MINIMAL series

Mitigeur temporisé douche avec alimentation externe série MINIMAL

Mezclador temporizado para ducha con alimentación externa colección MINIMAL

08133-30

Temporizzato 25 sec.

Timing 25 sec.

Temporisé 25 sec.

Temporización 25 seg.

08533F

Con pulsante antibloccaggio. Temporizzato 15 sec.

With vandal proof push-button. Timing 15 sec.

Avec poussoir anti-blocage. Temp. 15 sec.

Con pulsador anti-bloqueo. Temp. 15 seg.

08533-30F

Con pulsante antibloccaggio. Temporizzato 25 sec.

With vandal proof push-button. Timing 25 sec.

Avec poussoir anti-blocage. Temp. 25 sec.

Con pulsador anti-bloqueo. Temp. 25 seg.



12015 P. 166

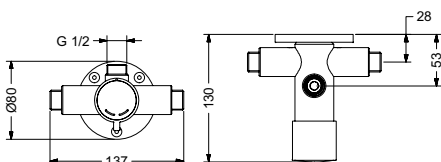

ART.	FINISHING	PACK.
08133	CHROME	1
08133-30	CHROME	1
08533F	CHROME	1
08533-30F	CHROME	1



08132



Unified
Water Label

8 l/min

Miscelatore temporizzato doccia 15 sec. serie MINIMAL
Self closing shower mixer 15 sec. MINIMAL series
Mitigeur temporisé douche 15 sec. série MINIMAL
Mezclador temporizado para ducha 15 seg. colección MINIMAL

08132-30

Temporizzato 25 sec.
Timing 25 sec.
Temporisé 25 sec.
Temporización 25 seg.

08532F



Con pulsante antibloccaggio. Temporizzato 15 sec.
With vandal proof push-button. Timing 15 sec.
Avec poussoir anti-blocage. Temp. 15 sec.
Con pulsador anti-bloqueo. Temp. 15 seg.

08532-30F



Con pulsante antibloccaggio. Temporizzato 25 sec.
With vandal proof push-button. Timing 25 sec.
Avec poussoir anti-blocage. Temp. 25 sec.
Con pulsador anti-bloqueo. Temp. 25 seg.

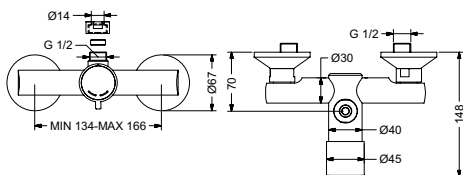

ART.	FINISHING	PACK.
08132	CHROME	1
08132-30	CHROME	1
08532F	CHROME	1
08532-30F	CHROME	1

**08137**Unified
Water Label

8 l/min

Miscelatore temporizzato per doccia 15 sec. serie MINIMAL
 Self-closing mixer for shower 15 sec. MINIMAL series
 Mitigeur temporisé pour douche 15 sec. série MINIMAL
 Mezclador temporizado para ducha 15 seg. colección MINIMAL

08137-30

Temporizzato 25 sec.
 Timing 25 sec.
 Temporisé 25 sec.
 Temporización 25 seg.

08537F

Con pulsante antibloccaggio. Temporizzato 15 sec.
 With vandal proof push-button. Timing 15 sec.
 Avec poussoir anti-blocage. Temp. 15 sec.
 Con pulsador anti-bloqueo. Temp. 15 seg.

08537-30F

Con pulsante antibloccaggio. Temporizzato 25 sec.
 With vandal proof push-button. Timing 25 sec.
 Avec poussoir anti-blocage. Temp. 25 sec.
 Con pulsador anti-bloqueo. Temp. 25 seg.



12015 P. 166

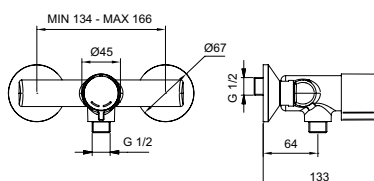

ART.	FINISHING	PACK.
08137	CHROME	1
08137-30	CHROME	1
08537F	CHROME	1
08537-30F	CHROME	1



08142



Unified
Water Label

8 l/min

Miscelatore temporizzato doccia da incasso 15 sec. serie MINIMAL

Concealed self closing shower mixer 15 sec. MINIMAL series

Mitigeur temporisé douche encastré 15 sec. série MINIMAL

Mezclador temporizado para ducha fijación empotrada 15 seg. colección MINIMAL

08142-30

Temporizzato 25 sec.

Timing 25 sec.

Temporisé 25 sec.

Temporización 25 seg.

08542F



Con pulsante antibloccaggio. Temporizzato 15 sec.

With vandal proof push-button. Timing 15 sec.

Avec poussoir anti-blocage. Temp. 15 sec.

Con pulsador anti-bloqueo. Temp. 15 seg.

08542-30F



Con pulsante antibloccaggio. Temporizzato 25 sec.

With vandal proof push-button. Timing 25 sec.

Avec poussoir anti-blocage. Temp. 25 sec.

Con pulsador anti-bloqueo. Temp. 25 seg.

TMIM4-00000

Con sistema anti-ristagno

With anti-stagnation system

Avec système anti-stagnation

Con sistema anti-estancamiento

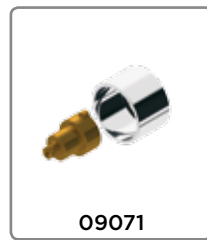
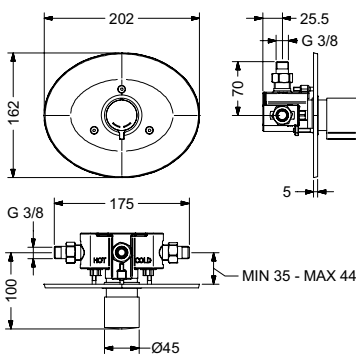

09071

SU RICHIESTA / ON DEMAND / SUR DEMAND / A PETICIÓN

D1 Nero - Black - Noir - Negro
E1 Bianco - White - Blanche - Blanco
O3 Oro - Gold - Or - Oro
2F Nickel - Nickel - Nickel - Níquel
N3 Rame - Copper - Cuivre - Cobre
R1 Grafite - Graphite - Graphite - Grafito

ART.	FINISHING	PACK.
08142	CHROME	1
08142-30	CHROME	1
08542F	CHROME	1
08542-30F	CHROME	1
09071	CHROME	1
TMIM4-00000	CHROME	1



08142/1



Unified Water Label  8 l/min

Miscelatore temporizzato doccia da incasso con scatola di protezione 15sec. serie MINIMAL
 Concealed self closing shower mixer with protection box 15 sec. MINIMAL series
 Mitigeur temporisé douche encastré avec boîte de protection 15 sec. série MINIMAL
 Mezclador temporizado para ducha fijación empotrada con caja de protección 15 seg. colección MINIMAL

08142/1-30

Temporizzato 25 sec.
 Timing 25 sec.
 Temporisé 25 sec.
 Temporización 25 seg.

08542/1F



Con pulsante antibloccaggio. Temporizzato 15 sec.
 With vandal proof push-button. Timing 15 sec.
 Avec poussoir anti-blocage. Temp. 15 sec.
 Con pulsador anti-bloqueo. Temp. 15 seg.

08542/1-30F



Con pulsante antibloccaggio. Temporizzato 25 sec.
 With vandal proof push-button. Timing 25 sec.
 Avec poussoir anti-blocage. Temp. 25 sec.
 Con pulsador anti-bloqueo. Temp. 25 seg.

TMIM4-04000

Con sistema anti-ristagno
 With anti-stagnation system
 Avec système anti-stagnation
 Con sistema anti-estancamiento

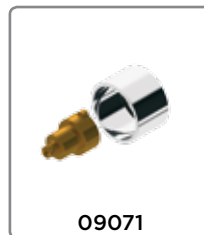
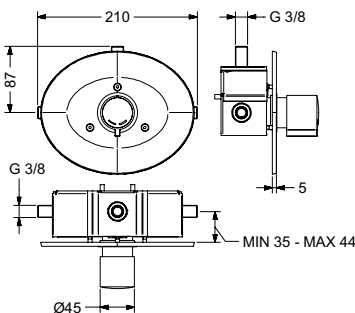

09071

SU RICHIESTA / ON DEMAND / SUR DEMAND / A PETICIÓN

- D1** Nero - Black - Noir - Negro
- E1** Bianco - White - Blanche - Blanco
- O3** Oro - Gold - Or - Oro
- 2F** Nickel - Nickel - Nickel - Níquel
- N3** Rame - Copper - Cuivre - Cobre
- R1** Grafite - Graphite - Graphite - Grafito

ART.	FINISHING	PACK.
08142/1	CHROME	1
08142/1-30	CHROME	1
08542/1F	CHROME	1
08542/1-30F	CHROME	1
09071	CHROME	1
TMIM4-04000	CHROME	1



08140/E



Rubinetto temporizzato doccia da incasso a parete 15 sec. serie MODERN
 Concealed self closing shower tap 15 sec. MODERN series
 Robinet de douche temporisé encastré 15 sec. série MODERN
 Grifo temporizado para ducha fijación empotrada 15 seg. colección MODERN

08140/E-30

Temporizzato 25 sec.
 Timing 25 sec.
 Temporisé 25 sec.
 Temporización 25 seg.

08540/E



Con pulsante antibloccaggio. Temporizzato regolabile
 With vandal proof push-button. Adjustable flow time
 Avec poussoir anti-blocage. Temporisation réglable
 Con pulsador anti-bloqueo. Temporización modificable

08540/EF



Con pulsante antibloccaggio. Temporizzato 15 sec.
 With vandal proof push-button. Timing 15 sec.
 Avec poussoir anti-blocage. Temp. 15 sec.
 Con pulsador anti-bloqueo. Temp. 15 seg.

08540/E-30F



Con pulsante antibloccaggio. Temporizzato 25 sec.
 With vandal proof push-button. Timing 25 sec.
 Avec poussoir anti-blocage. Temp. 25 sec.
 Con pulsador anti-bloqueo. Temp. 25 seg.

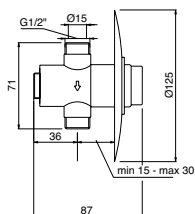

ART.	FINISHING	PACK.
08140/E	CHROME	1
08140/E-30	CHROME	1
08540/E	CHROME	1
08540/EF	CHROME	1
08540/E-30F	CHROME	1
09072	CHROME	1

**08130/E**

Rubinetto temporizzato doccia 15 sec. serie MODERN
Self closing shower tap 15 sec. MODERN series
Robinet de douche temporisé 15 sec. série MODERN
Grifo temporizado para ducha 15 seg. colección MODERN

08130/E-30

Temporizzato 25 sec.
Timing 25 sec.
Temporisé 25 sec.
Temporización 25 seg.

08530/E

Con pulsante antibloccaggio. Temporizzato regolabile
With vandal proof push-button. Adjustable flow time
Avec poussoir anti-blocage. Temporisation réglable
Con pulsador anti-bloqueo. Temporización modificable

08530/EF

Con pulsante antibloccaggio. Temporizzato 15 sec.
With vandal proof push-button. Timing 15 sec.
Avec poussoir anti-blocage. Temp. 15 sec.
Con pulsador anti-bloqueo. Temp. 15 seg.

08530/E-30F

Con pulsante antibloccaggio. Temporizzato 25 sec.
With vandal proof push-button. Timing 25 sec.
Avec poussoir anti-blocage. Temp. 25 sec.
Con pulsador anti-bloqueo. Temp. 25 seg.



12015 P. 166

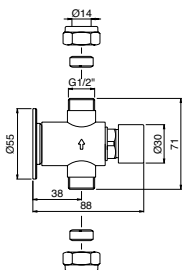

ART.	FINISHING	PACK.
08130/E	CHROME	1
08130/E-30	CHROME	1
08530/E	CHROME	1
08530/EF	CHROME	1
08530/E-30F	CHROME	1



08120-15



Rubinetto temporizzato doccia con alimentazione da parete 15 sec. serie MODERN
 Self closing shower tap with wall supply 15 sec. MODERN series
 Robinet de douche temporisé avec alimentation sur mur 15 sec. série MODERN
 Gripo temporizado ducha con alimentación de pared 15 sec. colección MODERN

08120-30

Temporizzato 25 sec.
 Timing 25 sec.
 Temporisé 25 sec.
 Temporización 25 seg.

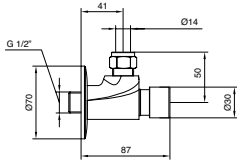

ART.	FINISHING	PACK.
08120-15	CHROME	1
08120-30	CHROME	1



12015

Saliscendi in ABS cromato con doccetta, flessibile e porta sapone
 Sliding rail in chromed ABS with hand shower, flexible hose and soap holder
 Coulissant en ABS chromé avec pomme de douche, flexible et porte savon
 Columna de deslizamiento en ABS cromado con ducha, flexible y porta jabón

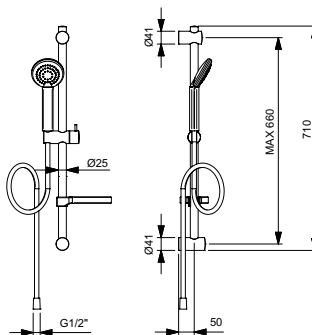

ART.	FINISHING	PACK.
12015	CHROME	1



09031



Braccio doccia antivandalo con soffione orientabile anticalcare
 Vandal proof shower arm with swivelling anti-limescale shower head
 Bras de douche anti-vandalisme avec pomme de douche orientable anticalcaire
 Brazo ducha antivandálico con rociador anti-caliza orientable

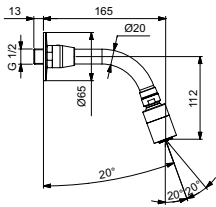

ART.	FINISHING	PACK.
09031	CHROME	1



09031/1



Soffione orientabile anticalcare
 Swivelling anti-limescale shower head
 Pomme de douche orientable anticalcaire
 Rociador de ducha orientable anti-caliza

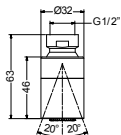

ART.	FINISHING	PACK.
09031/1	CHROME	1



09030/1



Rubinetto temporizzato doccia con comando a catenella e soffione serie MODERN
 Self closing shower tap with shower head, chain operated MODERN series
 Robinet de douche temporisé avec chaîne et pomme de douche série MODERN
 Grifo temporizado para ducha con rociador y mando con cadenita colección MODERN

09030/1I

Chiusura istantanea
 Instant cutting off
 Fermeture instantanée
 Cierre instantáneo

09030/1S

Versione con uscita 1/2"
 1/2" outlet version
 Version avec sortie 1/2"
 Versión con salida 1/2"

09030/1CU12

Curva di alimentazione a parete per art. 09030/1
 Wall elbow for art. 09030/1
 Coude d'alimentation murale pour art 09030/1
 Curva de alimentación de pared para art 09030/1

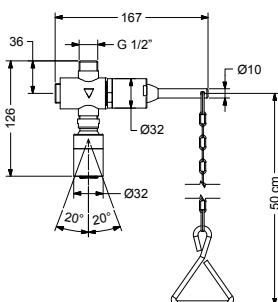

ART.	FINISHING	PACK.
09030/1	CHROME	1
09030/1I	CHROME	1
09030/1S	CHROME	1
09030/1CU12	CHROME	1



09036



Soffione doccia con possibilità di alimentazione esterna. Struttura antivandalo antiimpiccagione e diffusore anticalcare (fisso)

Vandal proof anti-ligature shower head with anti-limescale diffuser (fixed) suitable for external water supply

Pomme de douche avec possibilité d'alimentation externe. Structure anti-vandalisme et anti-pendaison avec diffuseur anticalcaire (fixe)

Rociador de ducha antivandálico y anti-ahorcamiento con difusor fijo anti-caliza, con posibilidad de alimentación externa

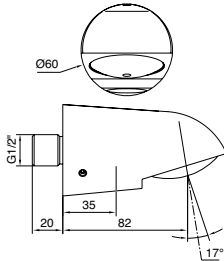

ART.	FINISHING	PACK.
09036	CHROME	1



09033



Soffione doccia antivandalo antiimpiccagione (fisso)

Vandal proof anti-ligature shower head (fixed)

Pomme de douche anti-vandalisme et anti-pendaison (fixe)

Rociador de ducha antivandálico a pared anti-ahorcamiento (fijo)

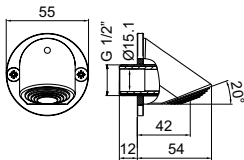

ART.	FINISHING	PACK.
09033	CHROME	1



09033/1



Soffione doccia antivandalo antiimpiccagione. Diffusore anticalcare orientabile

Vandal proof anti-ligature shower head. Anti-limescale swivelling diffuser

Pomme de douche anti-vandalisme et anti-pendaison. Diffuseur anticalcaire orientable

Rociador de ducha antivandálico y anti-ahorcamiento con difusor orientable anti-caliza

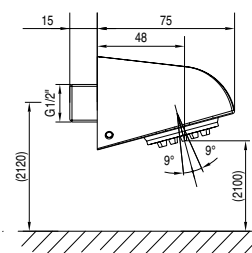

ART.	FINISHING	PACK.
09033/1	CHROME	1

**TDCM3-00000**

Pannello doccia in acciaio inox con miscelatore temporizzato 15 sec.

Stainless steel shower panel with self closing mixer 15 sec.

Panneau de douche mural en acier inox avec mitigeur temporisé 15 sec.

Panel ducha de pared en acero inox con mezclador temporizado 15 sec.

TDCM3-01000

Temporizzato 25 sec.

Timing 25 sec.

Temporisé 25 sec.

Temporización 25 seg.

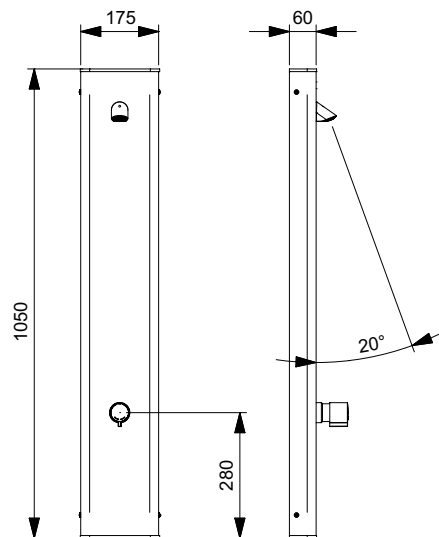

ART.	FINISHING	PACK.
TDCM3-00000	INOX	1
TDCM3-01000	INOX	1

**T98H3-00000**

Pannello doccia temporizzato in acciaio inox con miscelatore termostatico temporizzato serie 908

Self closing shower panel in stainless steel with thermostatic mixer 908 series

Panneau de douche temporisé en acier inox avec mitigeur thermostatique série 908

Panel de ducha temporizado en acero inox con mezclador temostático colección 908

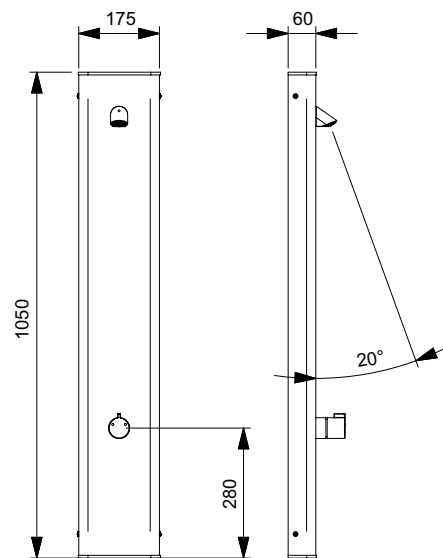

ART.

T98H3-00000

FINISHING

INOX

PACK.

1

**09290**

Pannello doccia temporizzato SLIM

SLIM self closing shower panel

Panneau de douche temporisé SLIM

Panel ducha temporizado SLIM

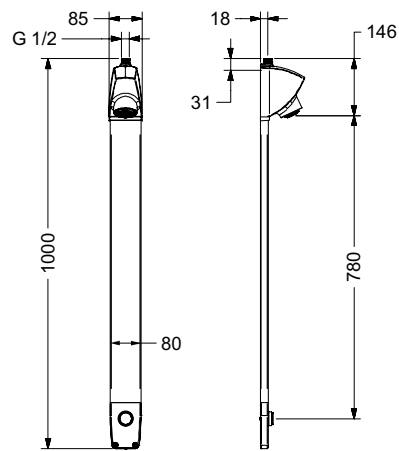

ART.

FINISHING

PACK.

09290

1





KSA32/31



Kit miscelatore temporizzato doccia 15 sec. con soffione doccia e tubo di collegamento serie MODERN

Kit self closing shower mixer 15 sec. with shower head and connecting tube MODERN series

Ensemble mitigeur temporisé douche 15 sec. avec pomme de douche et tuyau de connection série MODERN

Conjunto mezclador ducha temporizado 15 seg. con rociador y tubo de enlace colección MODERN

KSA32/31-30

Temporizzato 25 sec.

Timing 25 sec.

Temporisé 25 sec.

Temporización 25 seg.

09031KT32

Kit tubo + soffione

Kit tube + shower head

Ensemble tuyau + pomme de douche

Conjunto tubo + rociador de ducha

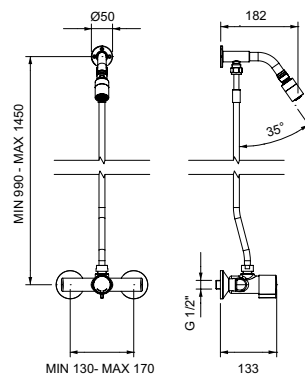

ART.	FINISHING	PACK.
KSA32/31	CHROME	1
KSA32/31-30	CHROME	1
09031KT32	CHROME	1
09031/E	CHROME	1

**KSA20/31**

Kit rubinetto temporizzato 15 sec. doccia con soffione doccia e tubo di collegamento serie MODERN

Kit self closing shower tap 15 sec. with shower head and connecting tube MODERN series

Ensemble robinet temporisé douche 15 sec. avec pomme de douche et tuyau de connection série MODERN

Conjunto grifo ducha temporizado 15 seg. con rociador y tubo de enlace colección MODERN

KSA20/31-30

Temporizzato 25 sec.

Timing 25 sec.

Temporisé 25 sec.

Temporización 25 seg.

09031KT20

Kit tubo + soffione

Kit tube + shower head

Ensemble tuyau + pomme de douche

Conjunto tubo + rociador de ducha

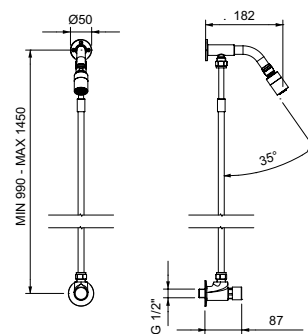

ART.	FINISHING	PACK.
KSA20/31	CHROME	1
KSA20/31-30	CHROME	1
09031KT20	CHROME	1
09031/E	CHROME	1



KSA32/36



Kit miscelatore temporizzato doccia 15 sec. con soffione doccia e tubo di collegamento serie MODERN

Kit self closing shower mixer 15 sec. with shower head and connecting tube MODERN series

Ensemble mitigeur temporisé douche 15 sec. avec pomme de douche et tuyau de connection série MODERN

Conjunto mezclador ducha temporizado 15 seg. con rociador y tubo de enlace colección MODERN

KSA32/36-30

Temporizzato 25 sec.

Timing 25 sec.

Temporisé 25 sec.

Temporización 25 seg.

09036KT32

Kit tubo + soffione

Kit tube + shower head

Ensemble tuyau + pomme de douche

Conjunto tubo + rociador de ducha

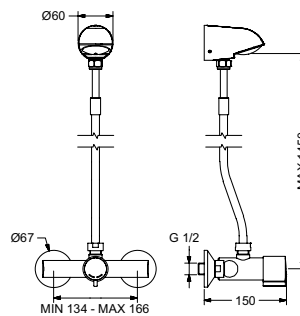

ART.	FINISHING	PACK.
KSA32/36	CHROME	1
KSA32/36-30	CHROME	1
09036KT32	CHROME	1



KSA20/36



Unified
Water Label

8 l/min

Kit rubinetto temporizzato 15 sec. doccia con soffione doccia e tubo di collegamento serie MODERN

Kit self closing shower tap 15 sec. with shower head and connecting tube MODERN series

Ensemble robinet temporisé douche 15 sec. avec pomme de douche et tuyau de connection série MODERN

Conjunto grifo ducha temporizado 15 seg. con rociador y tubo de enlace colección MODERN

KSA20/36-30

Temporizzato 25 sec.

Timing 25 sec.

Temporisé 25 sec.

Temporización 25 seg.

09036KT20

Kit tubo + soffione

Kit tube + shower head

Ensemble tuyau + pomme de douche

Conjunto tubo + rociador de ducha

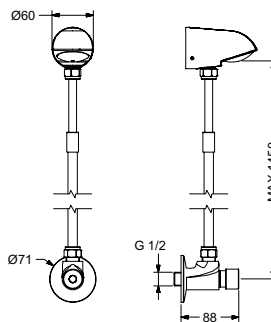

ART.	FINISHING	PACK.
KSA20/36	CHROME	1
KSA20/36-30	CHROME	1
09036KT20	CHROME	1



**09220**

Colonna doccia temporizzata singola posizione in acciaio inox
Stainless steel shower tower, single position self closing tap
Colonne de douche temporisée à 1 position en acier inox
Columna ducha temporizada de posición simple en acero inox

09231 (B)

Versione con miscelatore monocomando
Version with manual mixer
Version avec mitigeur monocommande
Versión con mezclador monomando

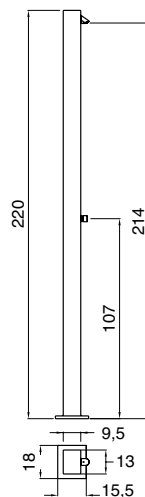
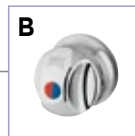

ART.	FINISHING	PACK.
09220	INOX	1
09231	INOX	1



09220/L (A+C)



Colonna doccia temporizzata singola posizione in acciaio inox, con lavapiedi
 Stainless steel shower tower with single position self closing tap and foot washer
 Colonne de douche temporisée à 1 position en acier inox, avec lave-pieds
 Columna ducha temporizada de posición simple en acero inox, con lavapiés

09231/L (B+D)

Versione con miscelatore monocomando e rubinetto lavapiedi manuale
 Version with manual mixer and manual foot tap
 Version avec mitigeur monocommande et robinet lave-pieds manuel
 Versión con mezclador monomando y grifo lavapiés manual

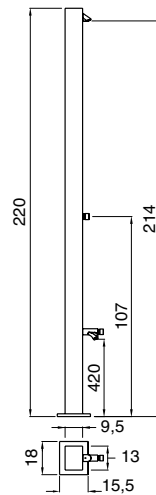
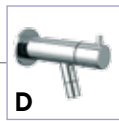
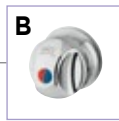

ART.	FINISHING	PACK.
09220/L (A+C)	INOX	1
09231/L (B+D)	INOX	1

**M84DX-00000**

Colonna doccia in acciaio inox AISI316L con miscelatore monocomando
Stainless steel AISI316L shower tower with single lever mixer
Colonne de douche en acier inox AISI316L avec mitigeur monocommande
Columna ducha en acero inox AISI316L con mezclador monomando

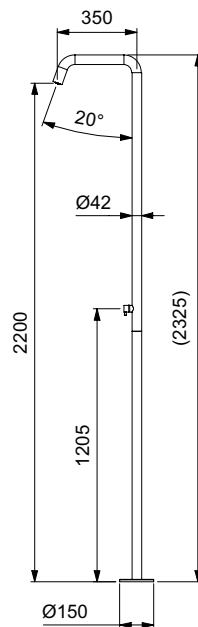

ART.

M84DX-00000

FINISHING

INOX

PACK.

1

**09224**

Colonna doccia temporizzata a 4 posizioni in acciaio inox
Stainless steel shower tower with 4-position self closing tap
Colonne de douche temporisée à 4 positions en acier inox
Columna ducha temporizada de 4 posiciones en acero inox

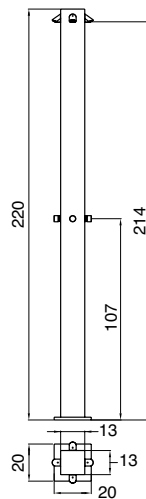
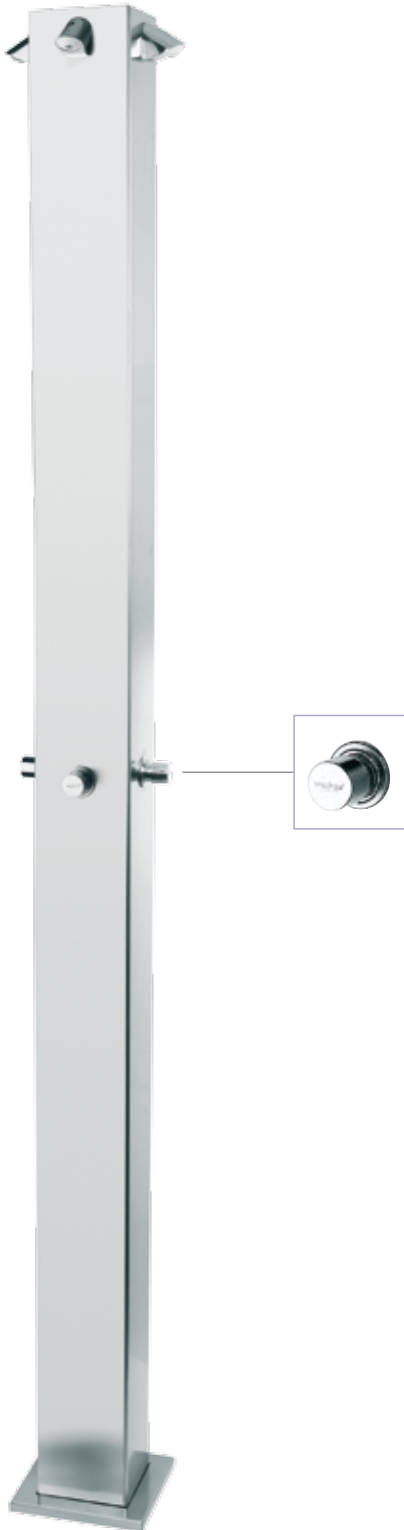
ART.
09224FINISHING
INOXPACK.
1





09260 (A+C)



8 l/min

Colonna doccia solare temporizzata, con lavapiedi
 Solar self closing shower column, with foot-washer
 Colonne de douche solaire temporisée avec lave-pieds
 Columna ducha solar temporizada, con lavapiés

09261 (B+D)

Versione con miscelatore monocomando e rubinetto lavapiedi manuale
 Version with manual mixer and manual foot tap
 Version avec mitigeur monocommande et robinet lave-pieds manuel
 Versión con mezclador monomando y grifo lavapiés manual

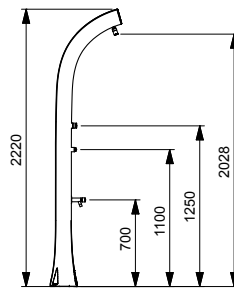
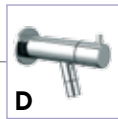
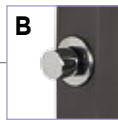

09260

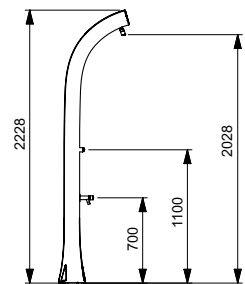

09261

SU RICHIESTA / ON DEMAND / SUR DEMAND / A PETICIÓN

- D1** Nero - Black - Noir - Negro
- E1** Bianco - White - Blanche - Blanco
- O3** Oro - Gold - Or - Oro
- 2F** Nickel - Nickel - Nickel - Níquel
- N3** Rame - Copper - Cuivre - Cobre
- R1** Grafite - Graphite - Graphite - Grafito

ART.	FINISHING	PACK.
09260 (A+C)	BLACK	1
09261 (B+D)	BLACK	1



09270 (A+C)



Colonna doccia solare temporizzata in alluminio, con lavapiedi
 Solar self-closing shower column in aluminum, with foot-washer
 Colonne de douche solaire temporisée en aluminium avec lave-pieds
 Columna ducha solar temporizada en aluminio con lavapiés

09271 (B+D)

Versione con miscelatore monocomando e rubinetto lavapiedi manuale
 Version with manual mixer and manual foot tap
 Version avec mitigeur monocommande et robinet lave-pieds manuel
 Versión con mezclador monomando y grifo lavapiés manual

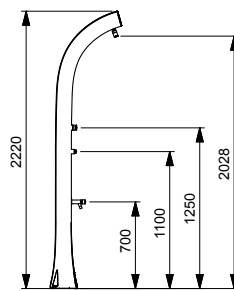
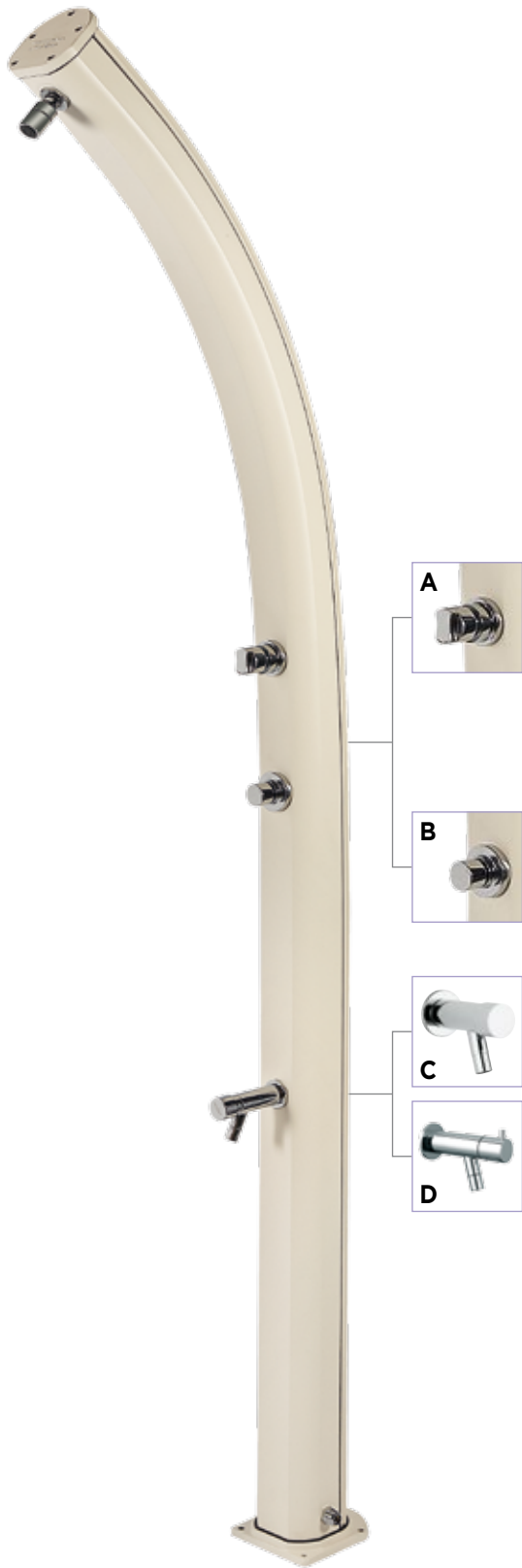

09270

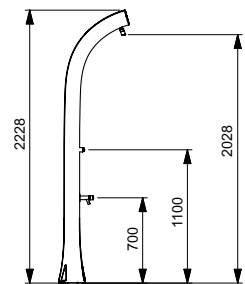

09271

SU RICHIESTA / ON DEMAND / SUR DEMAND / A PETICIÓN

- D1** Nero - Black - Noir - Negro
- E1** Bianco - White - Blanche - Blanco
- O3** Oro - Gold - Or - Oro
- 2F** Nickel - Nickel - Nickel - Níquel
- N3** Rame - Copper - Cuivre - Cobre
- R1** Grafite - Graphite - Graphite - Grafito

ART.	FINISHING	PACK.
09270 (A+C)	WHITE	1
09271 (B+D)	WHITE	1



Sistema di funzionamento

Operating system

Mode de fonctionnement

Sistema de funcionamiento

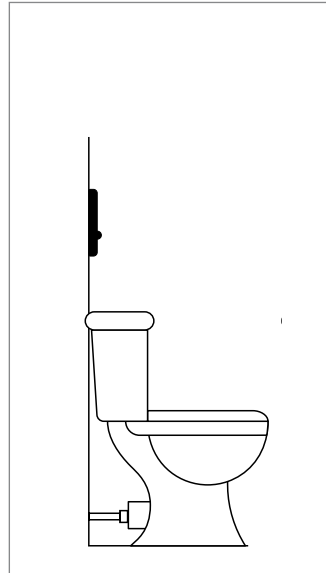

1

Non in funzione
Not working
Non-opérant
No en función

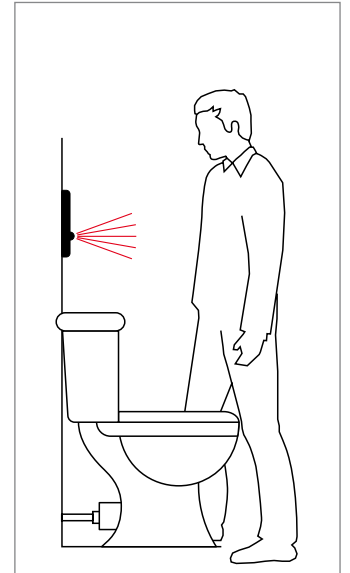

2

Rilevamento persona
Person detection
Détection de l'utilisateur
Detección del usuario

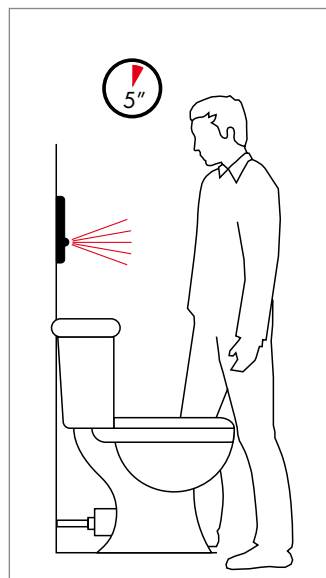

3

Permanenza di almeno 5 sec.
Permanence of at least 5 sec.
Rester pour au moins 5 secondes
Permanencia delante del sensor de un minimo de 5 segundos



4

L'orinatoio entra in funzione quando la fotocellula rileva l'allontanamento della persona
The urinal works when the sensor detects the person removal
L'urinoir commence à fonctionner comme l'utilisateur s'éloigne
El urinario empieza a funcionar en cuanto el usuario se aleja del sensor

**700.A7/R**

Flussometro elettronico WC da incasso con alimentazione da rete 230V serie 700
 Concealed WC electronic flush valve, 230V mains supply 700 series
 Robinet de chasse électronique encastré avec alimentation secteur 230V série 700
 Fluxor electrónico inodoro fijación empotrada, con alimentación de red 230V colección 700

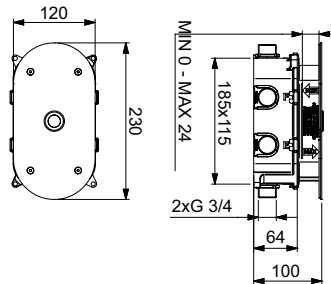
**SU RICHIESTA / ON DEMAND / SUR DEMAND / A PETICIÓN**

D1 Nero - Black - Noir - Negro
E1 Bianco - White - Blanche - Blanco
O3 Oro - Gold - Or - Oro
2F Nickel - Nickel - Nickel - Níquel
N3 Rame - Copper - Cuivre - Cobre
R1 Grafite - Graphite - Graphite - Grafito

ART.	FINISHING	PACK.
700.A7/R	CHROME	1

**700.B8/R**

Flussometro elettronico WC da incasso bicomando, con alimentazione da rete 230V serie 700
 Concealed WC electronic flush valve with double control, 230V mains supply 700 series
 Robinet de chasse électronique encastré bicommande, avec alimentation secteur 230V série 700
 Fluxor electrónico inodoro fijación empotrada doble mando, con alimentación de red 230V colección 700

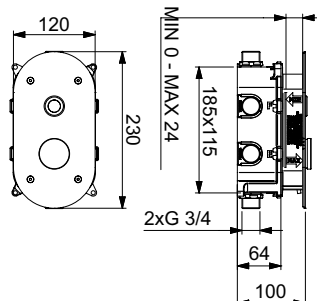
**SU RICHIESTA / ON DEMAND / SUR DEMAND / A PETICIÓN**

D1 Nero - Black - Noir - Negro
E1 Bianco - White - Blanche - Blanco
O3 Oro - Gold - Or - Oro
2F Nickel - Nickel - Nickel - Níquel
N3 Rame - Copper - Cuivre - Cobre
R1 Grafite - Graphite - Graphite - Grafito

ART.	FINISHING	PACK.
700.B8/R	CHROME	1

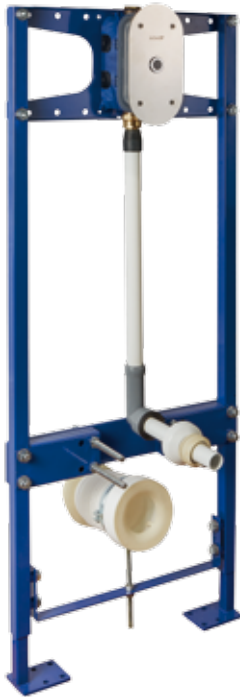
**I70N8-00000**

Struttura ad incasso completa con flussometro elettronico WC con alimentazione da rete 230V

Complete built-in structure with WC electronic flush valve, 230V mains supply

Structure complète encastré avec robinet de chasse électronique, alimentation secteur 230V

Estructura de soporte completa empotrada con fluxor electrónico inodoro, con alimentación de red 230V

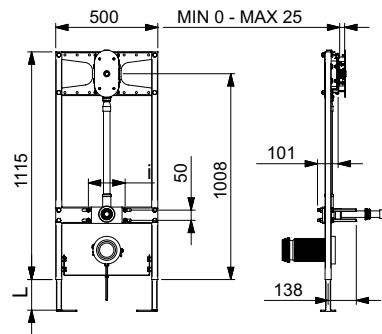

	MIN	MAX
I	180	230
L	0	150

ART.

FINISHING

PACK.

I70N8-00000

1

**I70N8-01000**

Struttura ad incasso completa con flussometro elettronico WC bicomando, con alimentazione da rete 230V

Complete built-in structure with WC electronic flush valve with double control, 230V mains supply

Structure complète encastré avec robinet de chasse électronique avec bicommande, alimentation secteur 230V

Estructura de soporte completa empotrada con fluxor electrónico inodoro double mando, con alimentación de red 230V

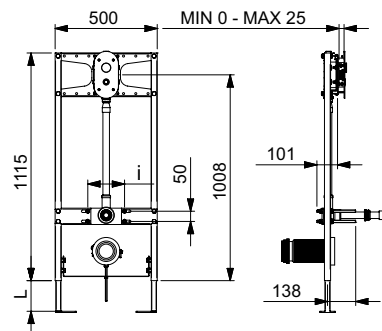

	MIN	MAX
I	180	230
L	0	150

ART.

FINISHING

PACK.

I70N8-01000

1

**08066-34**

Flussometro temporizzato WC 3/4" serie MODERN
 WC concealed self closing flush valve 3/4" MODERN series
 Robinet de chasse temporisé encastré 3/4" série MODERN
 Fluxor temporizado fijación empotrada para inodoro 3/4" colección MODERN

08066-1

Versione da 1"
 1" version
 Version 1"
 Versión 1"

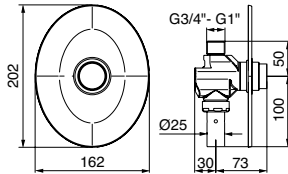
**09073**

ART.	FINISHING	PACK.
08066-34	CHROME	1
08066-1	CHROME	1
09073	CHROME	1

**08067-34**

Flussometro temporizzato WC da incasso con comando a leva antisvitamento 3/4" serie MODERN
 WC concealed self closing flush valve 3/4" with lever with unscrewing control system MODERN series
 Robinet de chasse temporisé encastré 3/4" avec manette anti-dévisage série MODERN
 Fluxor temporizado para inodoro fijación empotrada 3/4", con palanca no desatornillable colección MODERN

08067-1

Versione da 1"
 1" version
 Version 1"
 Versión 1"

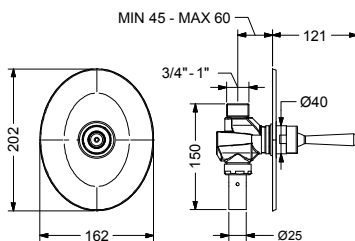

ART.	FINISHING	PACK.
08067-34	CHROME	1
08067-1	CHROME	1

**TMON8-00000**

Struttura ad incasso completa con flussometro temporizzato WC 3/4"

Complete built-in structure with self-closing WC flush valve 3/4"

Structure complète encastré avec robinet de chasse temporisé 3/4"

Estructura de soporte completa fijación empotrada con fluxor temporizado 3/4"

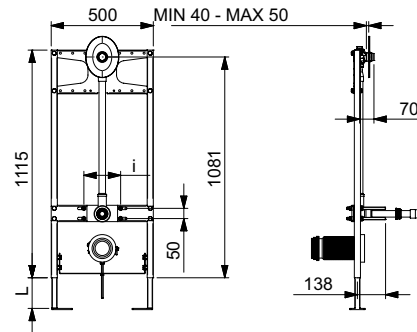

	MIN	MAX
I	180	230
L	0	150

ART.

FINISHING

PACK.

TMON8-00000

1

**TMON8-01000**

Struttura ad incasso completa con flussometro temporizzato WC 1"

Complete built-in structure with self-closing WC flush valve 1"

Structure complète encastré avec robinet de chasse temporisé 1"

Estructura de soporte completa fijación empotrada con fluxor temporizado 1"

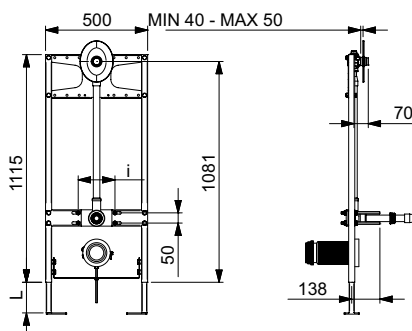

	MIN	MAX
I	180	230
L	0	150

ART.

FINISHING

PACK.

TMON8-01000

1

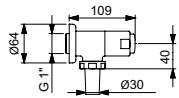
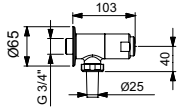
**08060/1-34**

Flussometro temporizzato WC 3/4" serie MODERN
 WC self closing flush valve 3/4" MODERN series
 Robinet de chasse temporisé 3/4" série MODERN
 Fluxor temporizado para inodoro 3/4" colección MODERN

08060/1-1

Versione da 1"
 1" version
 Version 1"
 Versión 1"

ART.	FINISHING	PACK.
08060/1-34	CHROME	1
08060/1-1	CHROME	1

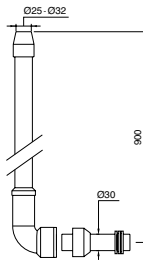
**08065TBK**

Tubo di scarico da incasso in plastica. Per flussometro WC 08066-08067
 Concealed plastic drain pipe for WC flush valve 08066-08067
 Tuyau de vidange encastré en plastique. Pour robinet de chasse 08066-08067
 Tubo de desagüe fijación empotrada en plástico. Para fluxor inodoro art. 08066-08067

ART.	FINISHING	PACK.
08065TBK		1

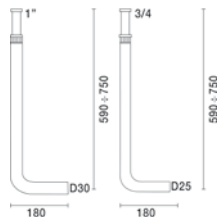
**08060/1TB34**

Tubo di scarico cromato per flussometro 08060/1-34
 Chrome pl. pipe for flush valve art. 08060/1-34
 Tuyau de vidange chromé pour robinet de chasse 08060/1-34
 Tubo de desagüe cromado para fluxor inodoro art. 08060/1-34

08060/1TB1

Per flussometro 08060/1-1
 For flush valve art. 08060/1-1
 Pour robinet de chasse 08060/1-1
 Para fluxor inodoro art. 08060/1-1

ART.	FINISHING	PACK.
08060/1TB34	CHROME	1
08060/1TB1	CHROME	1



Sistema di funzionamento

Operating system - Mode de fonctionnement - Sistema de funcionamiento

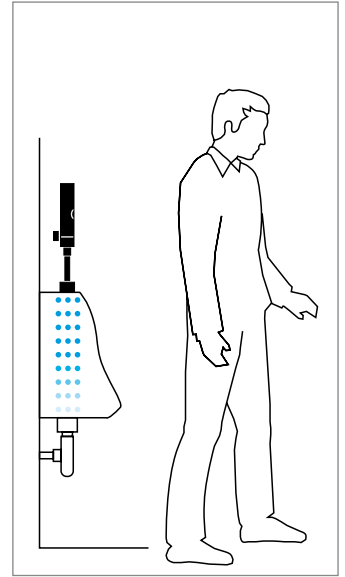
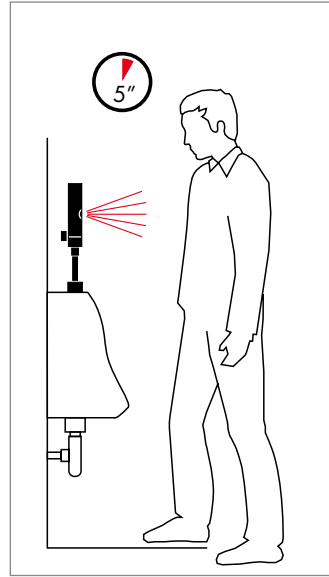
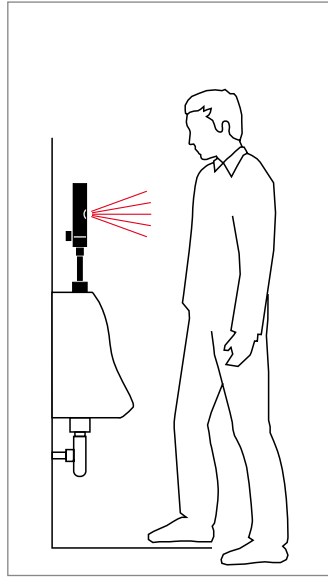
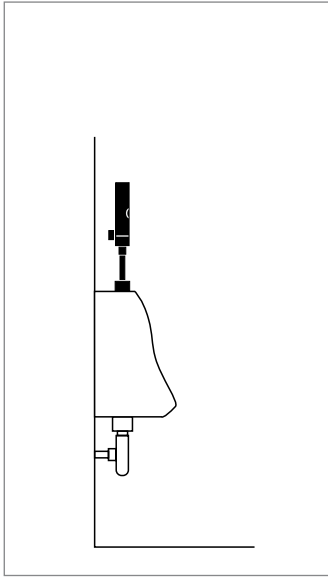



02524



Orinatoio elettronico in ceramica con alimentazione a batteria serie STYLE

Electronic ceramic urinal, powered by battery, STYLE series

Urinoir électronique céramique avec alimentation à piles série STYLE

Urinario electrónico cerámico, alimentación con batería colección STYLE

02524/R



Con alimentatore da rete 230V

Powered by mains 230V

Alimentation sur secteur 230V

Alimentación de red 230V

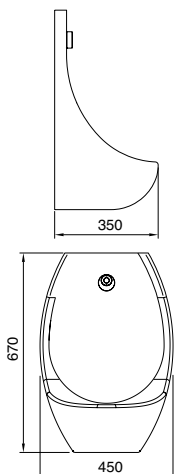

ART.	FINISHING	PACK.
02524	CHROME	1
02524/R	CHROME	1



02520/1



Rubinetto elettronico per orinatoio, alimentazione a batteria, serie ONE
 Electronic urinal tap, powered by battery, ONE series
 Robinet électronique pour urinoir, alimentation à piles, série ONE
 Grifo electrónico para urinario, alimentación con batería, colección ONE

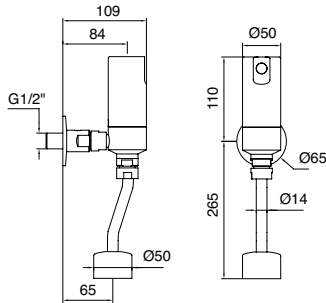

ART.	FINISHING	PACK.
02520/1	CHROME	1



700.A6



Rubinetto elettronico per orinatoio da incasso con alimentazione a batteria serie 700
 Concealed electronic urinal tap, powered by battery, 700 series
 Robinet électronique encastré pour urinoir avec alimentation à piles série 700
 Grifo electrónico empotrado para urinario, alimentación con batería colección 700

700.A6/R



Con alimentatore da rete 230V
 Powered by mains 230V
 Alimentation sur secteur 230V
 Alimentación 230V

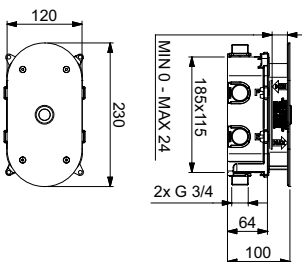

ART.	FINISHING	PACK.
700.A6	CHROME	1
700.A6/R	CHROME	1



08020/E



Rubinetto temporizzato per orinatoio serie CLASSIC
 Self closing urinal tap CLASSIC series
 Robinet temporisé pour urinoir série CLASSIC
 Grifo temporizado para urinario colección CLASSIC

08020/1E

Versión senza tubo
 Version without pipe
 Version sans tube
 Versión sin tubo

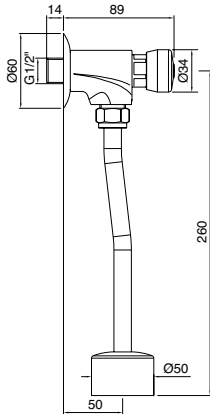

ART.	FINISHING	PACK.
08020/E	CHROME	1
08020/1E	CHROME	1



08120/E



Rubinetto temporizzato per orinatoio serie MODERN
 Self closing urinal tap MODERN series
 Robinet temporisé pour urinoir série MODERN
 Grifo temporizado para urinario colección MODERN

08120/1E

Versión senza tubo
 Version without pipe
 Version sans tube
 Versión sin tubo

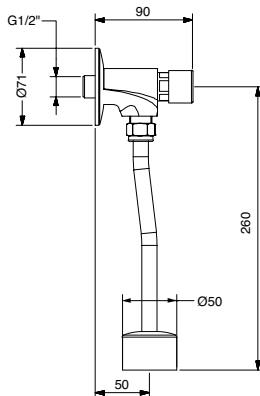

ART.	FINISHING	PACK.
08120/E	CHROME	1
08120/1E	CHROME	1

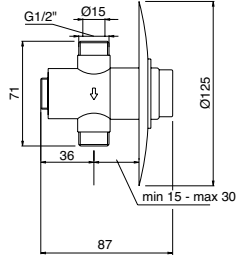

08125



Rubinetto temporizzato orinatoio da incasso serie CLASSIC
 Concealed self closing urinal tap CLASSIC series
 Robinet temporisé encastré pour urinoir série CLASSIC
 Grifo temporizado fijación empotrada para urinario colección CLASSIC



ART.	FINISHING	PACK.
08125	CHROME	1
09072	CHROME	1

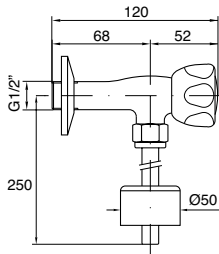

0230

Rubinetto a maniglia per orinatoio
 Urinal tap with handle
 Robinet à poignée pour urinoir
 Grifo urinario con pomo

ART.	FINISHING	PACK.
0230	CHROME	1



0236

Piletta di scarico per orinatoio
 Drain for urinal
 Bonde de vidage pour urinoir
 Válvula de desagüe para urinario

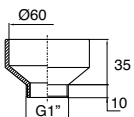

ART.	FINISHING	PACK.
0236	CHROME	1



12600



Pannello divisorio per orinatoio

Dividing wall for urinals

Panneau de séparation pour urinoirs

Panel de separación para urinarios

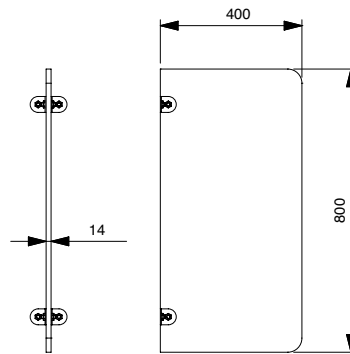

ART.

FINISHING

PACK.

12600

1



inox

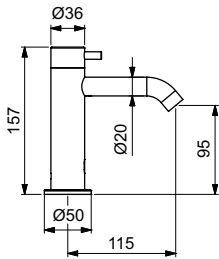

**184MO-00000**Unified
Water Label

6 l/min

Miscelatore elettronico lavabo in AISI 316L con alimentazione a batteria serie INOX

Electronic AISI 316L basin mixer, battery operated INOX series

Mitigeur de lavabo électronique en AISI 316L, alimentation à piles série INOX

*Mezclador electrónico para lavabo en AISI 316L, alimentación con batería colección INOX***184MO-01000**

Con alimentatore da rete 230V

Powered by mains 230V

Alimentation sur secteur 230V

*Alimentación de red 230V***1,9 l/min**

KT05LD - P. 271

ART.

FINISHING

PACK.

184MO-00000

INOX

1

184MO-01000

INOX

1

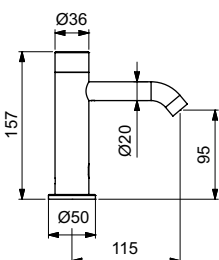
**184NO-01000**

Rubinetto elettronico lavabo in AISI 316L con alimentazione a batteria serie INOX

Electronic AISI 316L basin tap, battery operated INOX series

Robinet de lavabo électronique en AISI 316L, alimentation à piles série INOX

*Grifo electrónico para lavabo en AISI 316L, alimentación con batería colección INOX***184NO-02000**

Con alimentatore da rete 230V

Powered by mains 230V

Alimentation sur secteur 230V

*Alimentación de red 230V***1,9 l/min**

KT05LD - P. 271

ART.

FINISHING

PACK.

184NO-01000

INOX

1

184NO-02000

INOX

1

**I84M2-00000**Unified
Water Label

6 l/min



Miscelatore elettronico da incasso in AISI 316L per lavabo con alimentazione a batteria serie INOX
Electronic AISI 316L concealed basin mixer, battery operated INOX series

Mitigeur électronique encastré pour lavabo en AISI 316L, alimentation à piles série INOX

Mezclador electrónico empotrado para lavabo en AISI 316L, alimentación con batería colección INOX

I84M2-01000

Con alimentatore da rete 230V

Powered by mains 230V

Alimentation sur secteur 230V

Alimentación de red 230V

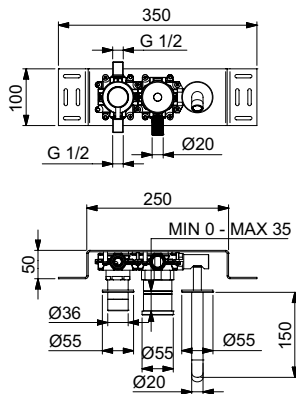

1,9 l/min



KT05LD - P. 271

**ON
OFF
SYSTEM**

ART.	FINISHING	PACK.
I84M2-00000	INOX	1
I84M2-01000	INOX	1

I84N2-00000Unified
Water Label

6 l/min



Rubinetto elettronico da incasso in AISI 316L per lavabo con alimentazione a batteria serie INOX
Electronic AISI 316L concealed basin tap, battery operated INOX series

Robinet électronique encastré pour lavabo en AISI 316L, alimentation à piles série INOX

Grifo electrónico empotrado para lavabo en AISI 316L, alimentación con batería colección INOX

I84N2-01000

Con alimentatore da rete 230V

Powered by mains 230V

Alimentation sur secteur 230V

Alimentación de red 230V

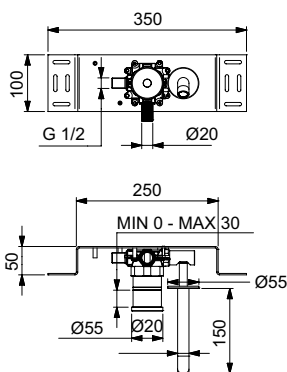

1,9 l/min



KT05LD - P. 271

**ON
OFF
SYSTEM**

ART.	FINISHING	PACK.
I84N2-00000	INOX	1
I84N2-01000	INOX	1

**I84M2-02000**

Miscelatore elettronico da incasso in AISI 316L per lavabo con alimentazione a batteria serie INOX
Electronic AISI 316L concealed basin mixer, battery operated INOX series
 Mitigeur électronique encastré pour lavabo en AISI 316L, alimentation à piles série INOX
 Mezclador electrónico empotrado para lavabo en AISI 316L, alimentación con batería colección INOX

I84M2-03000

Con alimentatore da rete 230V
Powered by mains 230V
 Alimentation sur secteur 230V
 Alimentación de red 230V



ART.	FINISHING	PACK.
I84M2-02000	INOX	1
I84M2-03000	INOX	1

**I84N2-02000**

Rubinetto elettronico da incasso in AISI 316L per lavabo con alimentazione a batteria serie INOX
Electronic AISI 316L concealed basin tap, battery operated INOX series
 Robinet électronique encastré pour lavabo en AISI 316L, alimentation à piles série INOX
 Grifo electrónico empotrado para lavabo en AISI 316L, alimentación con batería colección INOX

I84N2-03000

Con alimentatore da rete 230V
Powered by mains 230V
 Alimentation sur secteur 230V
 Alimentación de red 230V



ART.	FINISHING	PACK.
I84N2-02000	INOX	1
I84N2-03000	INOX	1

**I84M4-00000**

Miscelatore elettronico da incasso in AISI 316L per doccia con alimentazione a batteria serie INOX
Electronic AISI 316L concealed shower mixer, battery operated INOX series
 Mitigeur électronique encastré pour douche en AISI 316L, alimentation à piles série INOX
Mezclador electrónico empotrado para ducha en AISI 316L, alimentación con batería colección INOX

I84M4-01000

Con alimentatore da rete 230V
Powered by mains 230V
 Alimentation sur secteur 230V
Alimentación de red 230V

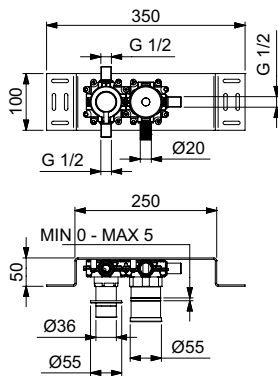

ART.	FINISHING	PACK.
I84M4-00000	INOX	1
I84M4-01000	INOX	1

**I84N4-00000**

Rubinetto elettronico da incasso doccia in AISI 316L con alimentazione a batteria serie INOX
Electronic AISI 316L concealed shower tap, battery operated INOX series
 Robinet électronique encastré pour douche en AISI 316L, alimentation à piles série INOX
Grifo electrónico empotrado para ducha en AISI 316L, alimentación con batería colección INOX

I84N4-01000

Con alimentatore da rete 230V
Powered by mains 230V
 Alimentation sur secteur 230V
Alimentación de red 230V

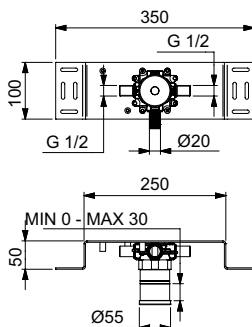

ART.	FINISHING	PACK.
I84N4-00000	INOX	1
I84N4-01000	INOX	1

**08410**

Rubinetto temporizzato lavabo serie INOX
 Self closing basin tap INOX series
 Robinet temporisé pour lavabo série INOX
 Grifo temporizado para lavabo colección INOX

08400PRO-50
08400PRO-100

1,9 l/min



KT05LD - P. 271

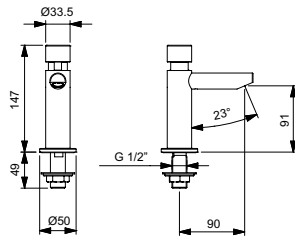

ART.	FINISHING	PACK.
08410	INOX	1
08400PRO-50	INOX	1
08400PRO-100	INOX	1

**08400**

Rubinetto temporizzato lavabo serie INOX
 Self-closing basin tap INOX series
 Robinet temporisé pour lavabo série INOX
 Grifo temporizado para lavabo colección INOX

08400PRO-50
08400PRO-100

1,9 l/min



KT05LD - P. 271

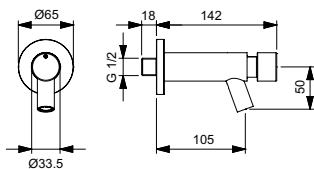

ART.	FINISHING	PACK.
08400	INOX	1
08400PRO-50	INOX	1
08400PRO-100	INOX	1

**08420/1**

Rubinetto temporizzato orinatoio serie INOX

Self closing urinal tap INOX series

Robinet temporisé pour urinoir série INOX

Grifo temporizado colección INOX para urinario

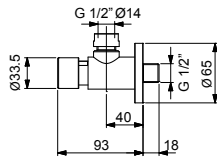
**08400PRO-50**
08400PRO-100

ART.	FINISHING	PACK.
08420/1	INOX	1
08400PRO-50	INOX	1
08400PRO-100	INOX	1

**08425**

Rubinetto temporizzato orinatoio da incasso serie INOX

Concealed self closing urinal tap INOX series

Robinet temporisé encastré pour urinoir série INOX

Grifo temporizado empotrado para urinario colección INOX

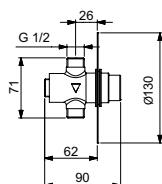

ART.	FINISHING	PACK.
08425	INOX	1

**08440**

Rubinetto temporizzato da incasso per doccia 15 sec. serie INOX
 Concealed self closing shower tap 15 sec. INOX series
 Robinet temporisé encastré pour douche 15 sec. série INOX
 Grifo temporizado empotrado para ducha 15 seg. colección INOX

08440-30

Temporizzato a 25 sec.
 Timing 25 sec.
 Temporisé 25 sec.
 Temporizado 25 seg.

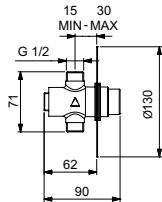

ART.	FINISHING	PACK.
08440	INOX	1
08440-30	INOX	1

**08430**

Rubinetto temporizzato per doccia 15 sec. serie INOX
 Self closing shower tap 15 sec. INOX series
 Robinet temporisé pour douche 15 sec. série INOX
 Grifo temporizado para ducha 15 seg. colección INOX

08430-30

Temporizzato a 25 sec.
 Timing 25 sec.
 Temporisé 25 sec.
 Temporizado 25 seg.

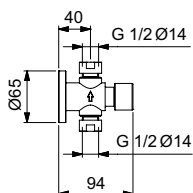

ART.	FINISHING	PACK.
08430	INOX	1
08430-30	INOX	1

**08420-15**

Rubinetto temporizzato per doccia 15 sec. serie INOX
 Self-closing shower tap 15 sec. INOX series
 Robinet temporisé pour douche 15 sec. série INOX
 Grifo temporizado para ducha 15 seg. colección INOX

08420-30

Temporizzato a 25 sec.
 Timing 25 sec.
 Temporisé 25 sec.
 Temporizado 25 seg.

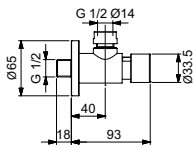
**08400PRO-50**
08400PRO-100

ART.	FINISHING	PACK.
08420-15	INOX	1
08420-30	INOX	1
08400PRO-50	INOX	1
08400PRO-100	INOX	1

**08431**

Braccio doccia antivandalo con soffione orientabile cilindrico anticalcare
 Vandal proof shower arm with moveable antilimescale shower head
 Bras de douche anti-vandalisme avec pomme de douche orientable cylindrique anticalcaire
 Brazo ducha antivandálico con rociador cilíndrico anticalizo orientable

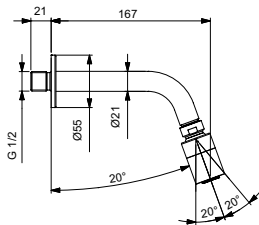

ART.	FINISHING	PACK.
08431	INOX	1

**08431/1**

Soffione orientabile cilindrico anticalcare
 Moveable antilimescale shower head
 Pomme de douche orientable cylindrique anticalcaire
 Rociador de ducha orientable cilíndrico anticalizo

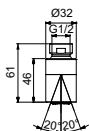

ART.	FINISHING	PACK.
08431/1	INOX	1



Z84CX-01000



Soffione doccia serie INOX
Shower head INOX series
Pomme de douche série INOX
Rociador de ducha colección INOX

Z84CX-00000

Braccio doccia L350 mm serie INOX
Shower arm L350 mm INOX series
Bras de douche L350 mm série INOX
Brazo de ducha L350 mm colección INOX

ART.	FINISHING	PACK.
Z84CX-01000	INOX	1
Z84CX-00000	INOX	1



Rubinetti **OLTREMURO** **CROSS WALL** taps

IDRAL, con la serie OLTREMURO prevede soluzioni su misura in grado di studiare prodotti personalizzati, prevedendo progetti specifici e prototipi pilota.

La serie è stata concepita come variante di rubinetti e bocche di erogazione tradizionali in modo che l'installazione possa essere effettuata in uno spazio "nascosto" all'utente e quindi con caratteristiche specifiche di antivandalismo e antimpiccagione. La serie OLTREMURO, oltre a garantire tutti i requisiti specifici della rubinetteria temporizzata, è la soluzione ideale laddove le esigenze di sicurezza e robustezza sono particolarmente elevate.

Facci sapere come possiamo aiutarti e saremo lieti di studiare una soluzione su misura per te.

With the OLTREMURO(CROSS WALL) series, IDRAL provides tailor-made solutions able to study customized products, including specific projects and pilot prototypes.

The series has been conceived as a variant of traditional taps and spouts so that the installation can be carried out in a "hidden" space to the user and therefore with specific characteristics of anti-vandalism and anti-hanging. The OLTREMURO(CROSS WALL) series, in addition to guaranteeing all the specific requirements of self closing taps, is the ideal solution where safety and robustness needs are particularly high.

Let us know how we can help you and we will be happy to study a tailored solution for you.

IDRAL, avec la série TRAVERS CLOISON propose des solutions sur mesure permettant d'étudier des produits personnalisés, des projets spécifiques et des prototypes pilotes.

La série a été conçue comme une variante des robinets et des becs traditionnels, de sorte que l'installation puisse être réalisée dans un espace caché pour l'utilisateur et donc avec des caractéristiques spécifiques de anti-vandalisme et d'anti-pendaison. La série TRAVERS CLOISON, en plus de garantir toutes les exigences spécifiques des robinets temporisés, est la solution idéale où les exigences en matière de sécurité et de robustesse sont particulièrement élevées.

Dites-nous comment nous pouvons vous aider et nous serons heureux d'étudier une solution sur mesure pour vous.

IDRAL, con la serie TRAS TABIQUE ofrece soluciones a petición para estudiar productos personalizados, incluso proyectos específicos y prototipos piloto.

La serie se ha concebido como una variante de los grifos y caño tradicionales para que la instalación pueda llevarse en un espacio "oculto" al usuario y por tanto con características específicas de vandalismo y anti-ahorcamiento. La serie TRAS TABIQUE, además de garantizar todos los requisitos específicos de los grifos temporizados, es la solución ideal donde los requisitos de seguridad y robustez son particularmente altos.

Háganos saber cómo podemos ayudarte y estaremos encantados de estudiar una solución personalizada para ti.



**08633-20**

Soffione doccia per pareti da 200mm (max) serie OLTREMURO
 Shower head for 200 mm (max) walls OLTREMURO series
 Pomme de douche pour murs de 200 mm (maxi) série OLTREMURO
 Rociador de ducha para paredes de 200mm (máx) colección OLTREMURO

ART.	FINISHING	PACK.
08633-20	CHROME	1

08640-20

Bocca erogazione per pareti da 200 mm (max) serie OLTREMURO
 Spout for 200 mm (max) walls OLTREMURO series
 Bec pour murs de 200 mm (maxi) série OLTREMURO
 Caño de descarga para paredes de 200mm (máx) colección OLTREMURO

ART.	FINISHING	PACK.
08640-20	CHROME	1

08651-20

Rubinetto temporizzato per pareti da 200 mm (max) serie OLTREMURO
 Self closing tap for 200 mm (max) walls OLTREMURO series
 Robinet temporisé pour murs de 200 mm (maxi) série OLTREMURO
 Grifo temporizado para paredes de 200 mm de espesor (máx) colección OLTREMURO

ART.	FINISHING	PACK.
08651-20	CHROME	1

08666-34-20

Flussometro temporizzato WC per pareti da 200 mm (max) serie OLTREMURO
 WC self closing flush valve for 200 mm (max) walls OLTREMURO series
 Robinet de chasse temporisé pour murs de 200mm (max) série OLTREMURO
 Fluxor temporizado inodoro para paredes de 200 mm (máx) colección OLTREMURO

ART.	FINISHING	PACK.
08666-34-20	CHROME	1





02179P25

Beverino con rubinetto a pulsante a chiusura istantanea
 Tap for drinking fountains, push button operated. Istantaneous shut-off
 Robinet à poussoir pour fontaines a fermeture instantanée
 Grifo con pulsador para fuentes. Cierre istántaneo

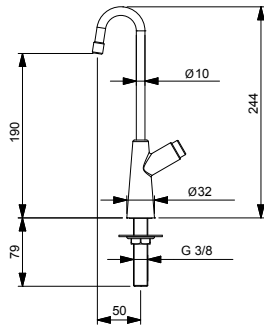

ART.	FINISHING	PACK.
02179P25	CHROME	1



02179L30

Beverino con rubinetto a leva a chiusura istantanea
 Tap for drinking fountains, lever operated. Istantaneous shut-off
 Robinet à levier pour fontaines à fermeture instantanée
 Grifo con palanca para fuentes. Cierre istántaneo

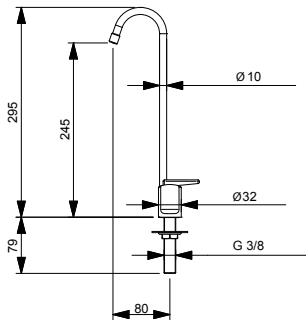

ART.	FINISHING	PACK.
02179L30	CHROME	1



02178

Beverino con rubinetto a pulsante a chiusura istantanea
 Tap for drinking fountains, push button operated. Istantaneous shut-off
 Robinet à poussoir pour fontaines a fermeture instantanée
 Grifo con pulsador para fuentes. Cierre istántaneo

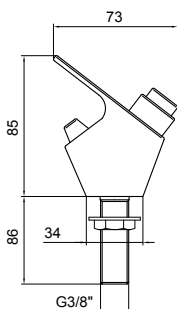

ART.	FINISHING	PACK.
02178	CHROME	1



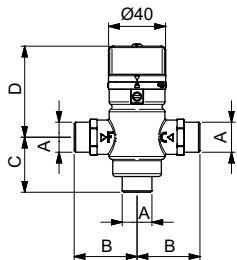

09028.1-12

Pre-miscelatore termostatico 1/2"
 Thermostatic pre-mixer 1/2"
 Pré-mitigeur thermostatique 1/2"
 Pre-mezclador termostático 1/2"

09028.1-34

Versione da 3/4"
 3/4" version
 Version 3/4"
 Versión 3/4"

ART.	FINISHING	PACK.
09028.1-12	CHROME	1
09028.1-34	CHROME	1

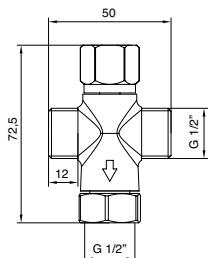

09026/1

Premiscelatore manuale 1/2"
 Manual pre-mixer 1/2"
 Pré-mitigeur manuel 1/2"
 Pre-mezclador manual 1/2"

ART.	FINISHING	PACK.
09026/1	CHROME	1

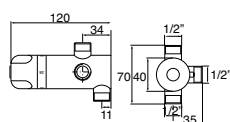

09029

Miscelatore termostatico sottoboiler
 Under boiler thermostatic mixer
 Mitigeur thermostatique sous chauffe-eau
 Mezclador termostático bajo calentador de agua

ART.	FINISHING	PACK.
09029	CHROME	1



CHE COS'È UN CONDIZIONATORE D'ACQUA ACTIVFLO?

ActivFlo è un condizionatore d'acqua catalitico progettato per aiutare a proteggere e ridurre la formazione di calcare nei sistemi fluidi. L'unità è predisposta per essere installata sulla rete in ingresso nelle proprietà o per una protezione indipendente sui componenti del sistema.

WHAT IS AN ACTIVFLO WATER CONDITIONER?

ActivFlo is a catalytic water conditioner designed to help protect and reduce limescale formations in fluid systems. The unit is designed to be installed onto the incoming water supply in properties or for an independent protection on system components.



QU'EST QUE C'EST UN CONDITIONNEUR D'EAU ACTIVFLO?

Activflo est un conditionneur d'eau catalytique conçu pour protéger et réduire la formation de calcaire dans les systèmes fluides. L'unité est conçue pour être installée sur le réseau entrant dans les propriétés ou pour assurer une protection indépendante sur les composants du système.

QUÉ ES UN ACONDICIONADOR DE AGUA ACTIVFLO?

Activflo es un acondicionador de agua catalítico diseñado para proteger y reducir la formación de piedra caliza en sistemas fluidos. La unidad está diseñada para ser instalada en la red que entra en las propiedades o para proporcionar protección independiente sobre los componentes del sistema.

**09027-34**

Condizionatore d'acqua anticalcare 3/4"
 Anti-limescale water conditioner 3/4"
 Conditionneur d'eau anti calcaire 3/4"
 Acondicionador de agua anti calizo 3/4"



ART.	L	Ø	FINISHING	PACK.
09027-34	200	3/4"	CHROME	1

**09027-1**

Versione da 1"
 1" version
 Version 1"
 Versión 1"

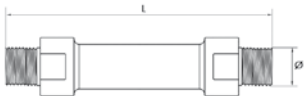

ART.	L	Ø	FINISHING	PACK.
09027-1	305	1"	CHROME	1

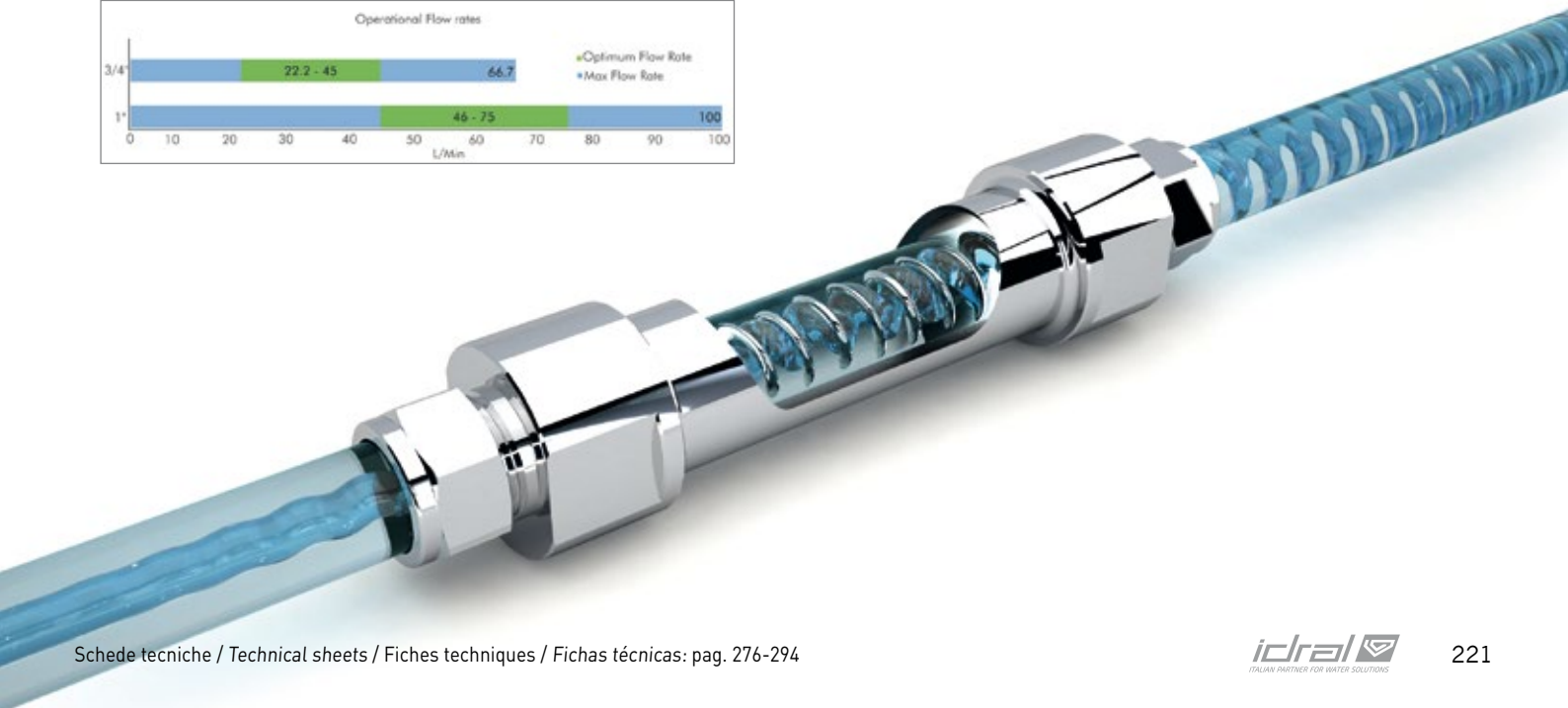
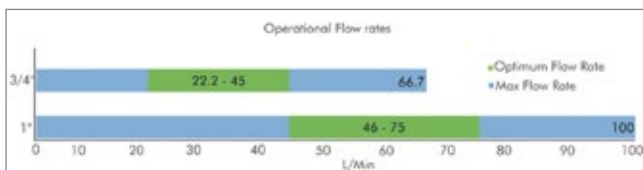



cucina



LK01: IL DESIGN CHE METTE LA TECNOLOGIA AL SERVIZIO DELL'AMBIENTE

Il nuovo miscelatore elettronico per cucina è ancora una volta frutto della collaborazione di Idral con il designer Luca Papini, nato allo scopo di migliorare l'esperienza in cucina ottimizzando il consumo d'acqua e di energia.

Questo prodotto infatti, oltre al vantaggio di attivarsi solo al bisogno con un semplice gesto davanti al sensore, ha anche una versione con cartuccia progressiva minimizzando così il consumo energetico.

E' disponibile con canna girevole e con doccetta estraibile e, oltre al cromato, sono previste altre finiture metalliche particolari.

LK01: DESIGN THAT PUTS TECHNOLOGY AT THE SERVICE OF THE ENVIRONMENT

The new electronic kitchen mixer is once again the result of Idral's collaboration with designer Luca Papini, created with the aim of improving the kitchen experience by optimising water and energy consumption.

In fact, this product, in addition to the advantage of activating the water flow only when needed with a simple gesture in front of the sensor, also has a version with a progressive cartridge, thus minimising energy consumption.

It is available with a swivel spout and pull-out spray and, in addition to chrome, other special metal finishes are foreseen.

LK01: LE DESIGN QUI MET LA TECHNOLOGIE AU SERVICE DE L'ENVIRONNEMENT

Le nouveau mitigeur électronique pour la cuisine est une fois de plus le résultat de la collaboration entre Idral et le designer Luca Papini, créé dans le but d'améliorer l'expérience dans la cuisine en optimisant la consommation d'eau et d'énergie.

En effet, ce produit, outre l'avantage de n'être activé qu'en cas de besoin d'un simple geste devant le capteur, dispose également d'une version avec une cartouche progressive, minimisant ainsi la consommation d'énergie.

Il est disponible avec un bec pivotant et avec une douchette extractible et, en plus du chrome, d'autres finitions métalliques particulières sont disponibles.

LK01: EL DISEÑO QUE PONE LA TECNOLOGÍA AL SERVICIO DEL MEDIO AMBIENTE

El nuevo mezclador electrónico para cocina es, una vez más, fruto de la colaboración entre Idral y el diseñador Luca Papini, creado con el objetivo de mejorar la experiencia en la cocina optimizando el consumo de agua y energía.

De hecho, este producto, además de la ventaja de activarse solo cuando se necesita con un simple gesto frente al sensor, también cuenta con una versión con cartucho progresivo, minimizando así el consumo de energía.

Está disponible con caño giratorio y con teleducha extraíble y, además del cromado, están disponibles otros acabados metálicos particulares.







**I55D0-04000**

Miscelatore elettronico per cucina con by-pass manuale e doccetta estraibile, alimentazione a batteria, serie LK01

Electronic kitchen mixer with manual by-pass and pull-out hand shower, powered by battery, LK01 series

Mitigeur électronique pour cuisine avec by-pass manuel et douchette extractible, alimentation à piles, série LK01

Mezclador electrónico para cocina con by-pass manual y teleducha extraíble, alimentación con batería, colección LK01

I55D0-05000

Versione con alimentatore da rete 230V

Powered by mains 230V version

Version avec alimentation sur secteur 230V

Versión con alimentación de red 230V

I55D0-00000

Versione con cartuccia progressiva e alimentazione a batteria

Version with progressive cartridge, powered by battery

Version avec cartouche progressive et alimentation à piles

Versión con cartucho progresivo y alimentación a batería

I55D0-01000

Versione con cartuccia progressiva e alimentazione a rete 230V

Version with progressive cartridge, powered by mains 230V

Version avec cartouche progressive et alimentation sur secteur 230V

Versión con cartucho progresivo y alimentación de red 230V

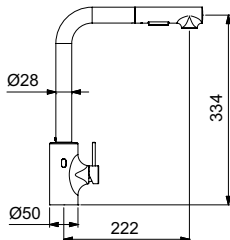
**SU RICHIESTA / ON DEMAND / SUR DEMAND / A PETICIÓN**

D1 Nero - Black - Noir - Negro
E1 Bianco - White - Blanche - Blanco
O3 Oro - Gold - Or - Oro
2F Nickel - Nickel - Nickel - Níquel
N3 Rame - Copper - Cuivre - Cobre
R1 Grafite - Graphite - Graphite - Grafito

ART.	FINISHING	PACK.
I55D0-04000	CHROME	1
I55D0-05000	CHROME	1
I55D0-00000	CHROME	1
I55D0-01000	CHROME	1

**I55DO-12000**

Miscelatore elettronico per cucina con by-pass manuale e doccetta estraibile, alimentazione a batteria, serie LK01

Electronic kitchen mixer with manual by-pass and pull-out hand shower, powered by battery, LK01 series

Mitigeur électronique pour cuisine avec by-pass manuel et douchette extractible, alimentation à piles, série LK01

Mezclador electrónico para cocina con by-pass manual y teleducha extraíble, alimentación con batería, colección LK01

I55DO-13000

Versione con alimentatore da rete 230V

Powered by mains 230V version

Version avec alimentation sur secteur 230V

Versión con alimentación de red 230V

I55DO-08000

Versione con cartuccia progressiva e alimentazione a batteria

Version with progressive cartridge, powered by battery

Version avec cartouche progressive et alimentation à piles

Versión con cartucho progresivo y alimentación a batería

I55DO-09000

Versione con cartuccia progressiva e alimentazione a rete 230V

Version with progressive cartridge, powered by mains 230V

Version avec cartouche progressive et alimentation sur secteur 230V

Versión con cartucho progresivo y alimentación de red 230V

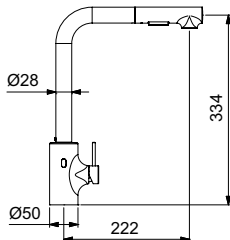
**SU RICHIESTA / ON DEMAND / SUR DEMAND / A PETICIÓN**

D1 Nero - Black - Noir - Negro
E1 Bianco - White - Blanche - Blanco
O3 Oro - Gold - Or - Oro
2F Nickel - Nickel - Nickel - Níquel
N3 Rame - Copper - Cuivre - Cobre
R1 Grafite - Graphite - Graphite - Grafito

ART.

I55DO-12000
 I55DO-13000
 I55DO-08000
 I55DO-09000

FINISHING

METALLIC GREY
 METALLIC GREY
 METALLIC GREY
 METALLIC GREY

PACK.

1
 1
 1
 1

**I55D0-06000**

Miscelatore elettronico per cucina con by-pass manuale e canna girevole, alimentazione a batteria, serie LK01

Electronic kitchen mixer with manual by-pass and Swinging spout, powered by battery, LK01 series

Mitigeur électronique pour cuisine avec by-pass manuel et bec tournant, alimentation à piles, série LK01

Mezclador electrónico para cocina con by-pass manual y caño giratorio, alimentación con batería, colección LK01

I55D0-07000

Versione con alimentatore da rete 230V

Powered by mains 230V version

Version avec alimentation sur secteur 230V

Versión con alimentación de red 230V

I55D0-02000

Versione con cartuccia progressiva e alimentazione a batteria

Version with progressive cartridge, powered by battery

Version avec cartouche progressive et alimentation à piles

Versión con cartucho progresivo y alimentación a batería

I55D0-03000

Versione con cartuccia progressiva e alimentazione a rete 230V

Version with progressive cartridge, powered by mains 230V

Version avec cartouche progressive et alimentation sur secteur 230V

Versión con cartucho progresivo y alimentación de red 230V

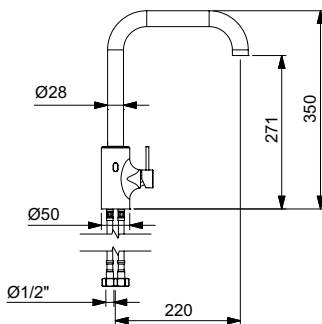
**SU RICHIESTA / ON DEMAND / SUR DEMAND / A PETICIÓN**

D1 Nero - Black - Noir - Negro
E1 Bianco - White - Blanche - Blanco
O3 Oro - Gold - Or - Oro
2F Nickel - Nickel - Nickel - Níquel
N3 Rame - Copper - Cuivre - Cobre
R1 Grafite - Graphite - Graphite - Grafito

ART.	FINISHING	PACK.
I55D0-06000	CHROME	1
I55D0-07000	CHROME	1
I55D0-02000	CHROME	1
I55D0-03000	CHROME	1

**I55DO-14000**

Miscelatore elettronico per cucina con by-pass manuale e canna girevole, alimentazione a batteria, serie LK01

Electronic kitchen mixer with manual by-pass and Swinging spout, powered by battery, LK01 series

Mitigeur électronique pour cuisine avec by-pass manuel et bec tournant, alimentation à piles, série LK01

Mezclador electrónico para cocina con by-pass manual y caño giratorio, alimentación con batería, colección LK01

I55DO-15000

Versione con alimentatore da rete 230V

Powered by mains 230V version

Version avec alimentation sur secteur 230V

Versión con alimentación de red 230V

I55DO-10000

Versione con cartuccia progressiva e alimentazione a batteria

Version with progressive cartridge, powered by battery

Version avec cartouche progressive et alimentation à piles

Versión con cartucho progresivo y alimentación a batería

I55DO-11000

Versione con cartuccia progressiva e alimentazione a rete 230V

Version with progressive cartridge, powered by mains 230V

Version avec cartouche progressive et alimentation sur secteur 230V

Versión con cartucho progresivo y alimentación de red 230V

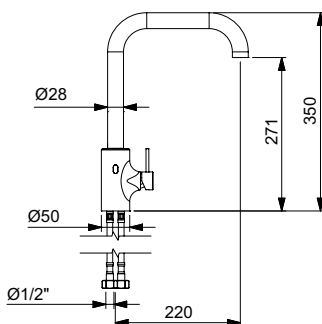
**SU RICHIESTA / ON DEMAND / SUR DEMAND / A PETICIÓN**

D1 Nero - Black - Noir - Negro
E1 Bianco - White - Blanche - Blanco
O3 Oro - Gold - Or - Oro
2F Nickel - Nickel - Nickel - Níquel
N3 Rame - Copper - Cuivre - Cobre
R1 Grafite - Graphite - Graphite - Grafito

ART.	FINISHING	PACK.
I55DO-14000	METALLIC GREY	1
I55DO-15000	METALLIC GREY	1
I55DO-10000	METALLIC GREY	1
I55DO-11000	METALLIC GREY	1

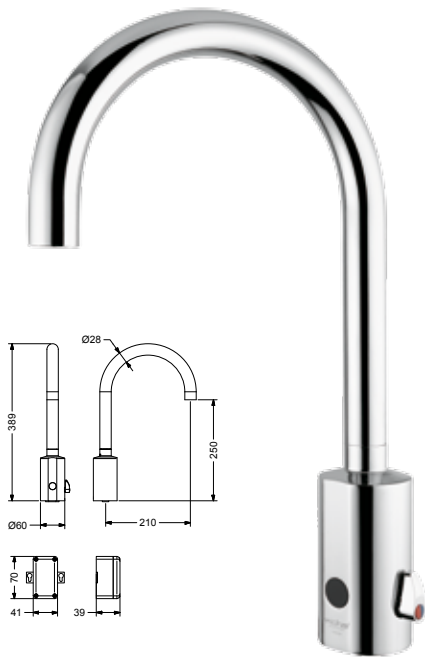

**02506**Unified
Water Label

6 l/min

Miscelatore elettronico per lavabo/lavello con alimentazione a batteria serie CURVE
 Electronic basin/sink mixer, battery operated CURVE series
 Mitigeur électronique lavabo/évier, alimentation à piles série CURVE
 Mezclador electrónico para lavabo/fregadero, alimentación con batería colección CURVE

02506/R

Con alimentatore da rete 230V
 Powered by mains 230V
 Alimentation sur secteur 230V
 Alimentación de red 230V

SU RICHIESTA / ON DEMAND / SUR DEMAND / A PETICIÓN

D1 Nero - Black - Noir - Negro
E1 Bianco - White - Blanche - Blanco
O3 Oro - Gold - Or - Oro
2F Nickel - Nickel - Nickel - Níquel
N3 Rame - Copper - Cuivre - Cobre
R1 Grafite - Graphite - Graphite - Grafito

ART.	FINISHING	PACK.
02506	CHROME	1
02506/R	CHROME	1



**09426/03**

Miscelatore cucina con doccia dual jet ad aggancio magnetico
 Kitchen mixer with double jet shower and magnetic hooking
 Mitigeur cuisine avec douchette à deux jets et fixation magnétique
 Mezclador cocina con ducha con doble chorro y conexión magnética

09426/03L

Versione con leva clinica
 Version with clinical lever
 Version avec manette clinique
 Versión con palanca medical



Aggancio magnetico
 Magnetic hooking
 Fixation magnétique
 Conexión magnética

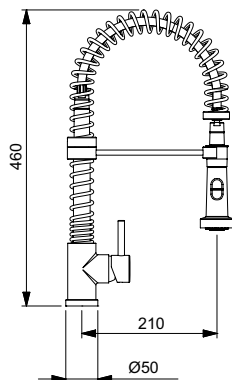

ART.	FINISHING	PACK.
09426/03	CHROME	1
09426/03L	CHROME	1



chef





**09480**

Miscelatore a parete con leva corta
 Wall mounted mixer with short lever
 Mitigeur mural avec manette courte
 Mezclador de pared con palanca corta

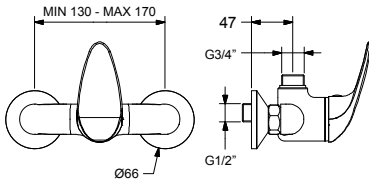

ART.	FINISHING	PACK.
09480	CHROME	1

**09485**

Miscelatore con leva corta
 Mixer with short lever
 Mitigeur avec manette courte
 Mezclador con palanca corta

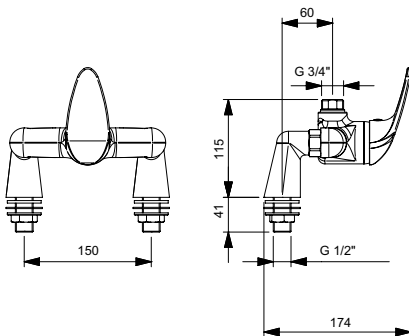

ART.	FINISHING	PACK.
09485	CHROME	1

**09490**

Miscelatore con leva clinica laterale
 Mixer with side clinic lever
 Mitigeur avec levier à bras latéral
 Mezclador con palanca medical lateral

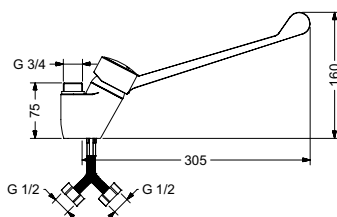

ART.	FINISHING	PACK.
09490	CHROME	1



**09450/DC**

Miscelatore a parete con maniglie
 Wall mounted mixer with handles
 Mitigeur mural avec poignées
 Mezclador de pared con pomos

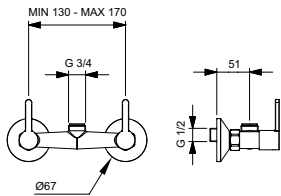

ART.	FINISHING	PACK.
09450/DC	CHROME	1

**09455/DC**

Miscelatore con maniglie
 Mixer with handles
 Mitigeur avec poignées
 Mezclador con pomos

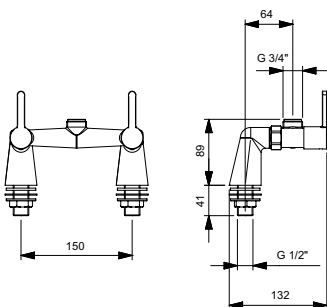

ART.	FINISHING	PACK.
09455/DC	CHROME	1

**09450/LDC**

Miscelatore a parete con leve
 Wall mounted mixer with levers
 Mitigeur mural avec manettes
 Mezclador de pared con palancas

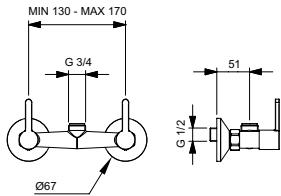

ART.	FINISHING	PACK.
09450/LDC	CHROME	1

**09455/LDC**

Miscelatore con leve
 Mixer with levers
 Mitigeur avec manette
 Mezclador con palancas

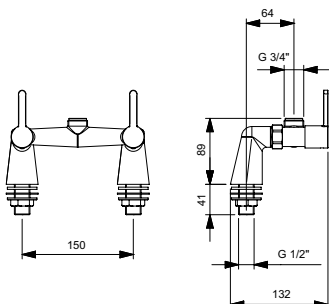

ART.	FINISHING	PACK.
09455/LDC	CHROME	1

**09440/DC**

Miscelatore con maniglie
 Mixer with handles
 Mitigeur avec poignées
 Mezclador con pomos

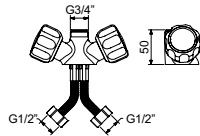

ART.	FINISHING	PACK.
09440/DC	CHROME	1

**09442/DC**

Miscelatore alta portata con maniglie
 High flow mixer with handles
 Mitigeur à débit élevé, avec poignées
 Mezclador con caudal elevado y con pomos

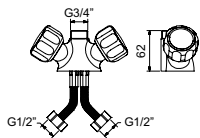

ART.	FINISHING	PACK.
09442/DC	CHROME	1

**09440/LDC**

Miscelatore con leve
 Mixer with levers
 Mitigeur avec manette
 Mezclador con palancas

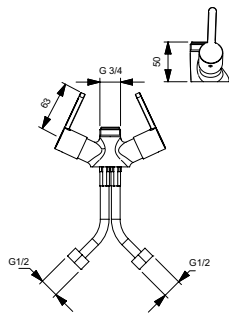

ART.	FINISHING	PACK.
09440/LDC	CHROME	1

**09442/LDC**

Miscelatore alta portata con leve
 High flow mixer with levers
 Mitigeur à débit élevé, avec manette
 Mezclador con caudal elevado y con palancas

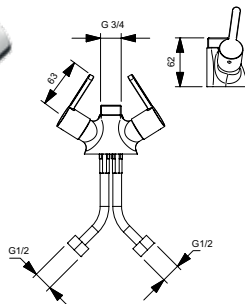

ART.	FINISHING	PACK.
09442/LDC	CHROME	1

**09470/DC**

Rubinetto con maniglia
 Tap with handle
 Robinet de lavabo avec poignée
 Grifo con pomo

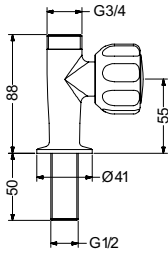

ART.	FINISHING	PACK.
09470/DC	CHROME	1

**09470/LDC**

Rubinetto con leva
 Tap with lever
 Robinet de lavabo avec manette
 Grifo con palanca

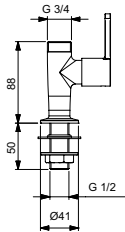

ART.	FINISHING	PACK.
09470/LDC	CHROME	1

**09435**

Basetta di fissaggio su piano per gruppi di prelavaggio e canne girevoli
 Deck mounted fixing base for pre-wash units and swivelling spouts
 Base de fixation sur plaque pour ensemble de pré-lavage et becs mobiles
 Bloque para fijación encimera de grupos de prelavado y caños giratorios

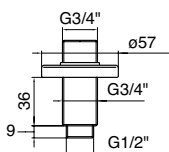

ART.	FINISHING	PACK.
09435	CHROME	1

**09500-350**

Bocca girevole 350 mm
Swivel spout 350 mm
Bec mobile 350 mm
Caño giratorio 350 mm

09500-240

Bocca girevole 240 mm
Swivel spout 240 mm
Bec mobile 240 mm
Caño giratorio 240 mm

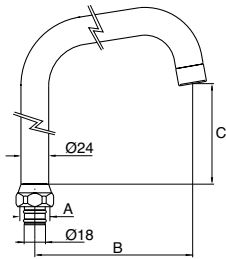

ART.	FINISHING	PACK.
09500-350	CHROME	1
09500-240	CHROME	1

**09500SE**

Bocca girevole a "S" telescopica 200-300 mm
Extensible "S" swivel spout 200-300 mm
Bec mobile en "S" extensible 200-300 mm
Caño de descarga giratorio en "S" extensible 200-300 mm

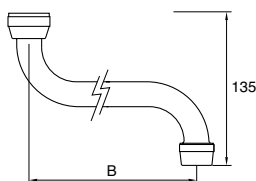
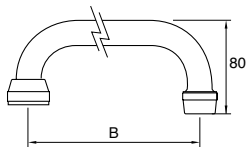

B = min. 200 mm - max. 300 mm

ART.	FINISHING	PACK.
09500SE	CHROME	1



**09488**

Miscelatore a parete con bocca girevole estensibile e comando a leva clinica
 Wall mounted mixer with extendible swivel spout and clinic lever
 Mitigeur mural avec bec mobile extensible et levier à bras
 Mezclador de pared con caño giratorio extensible y palanca medical

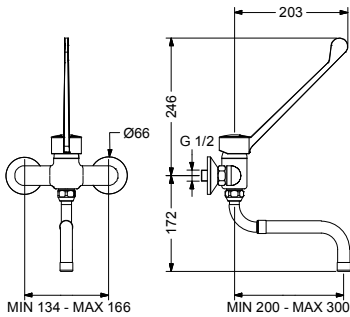

ART.	FINISHING	PACK.
09488	CHROME	1

**09495**

Miscelatore con bocca girevole e comando a leva clinica
 Mixer with swivel spout and clinic lever
 Mitigeur avec bec mobile et levier à bras
 Mezclador con caño giratorio y palanca medical

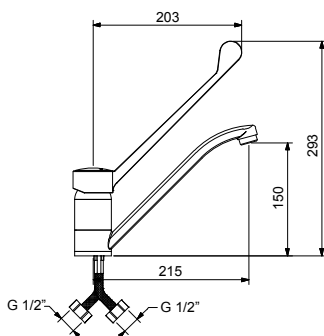

ART.	FINISHING	PACK.
09495	CHROME	1

**09497**

Miscelatore con bocca girevole, doccetta estraibile e comando a leva clinica
 Mixer with swivel spout, pull-out hand shower and clinic lever
 Mitigeur avec bec mobile, douchette extractible et levier à bras
 Mezclador con caño giratorio, ducha extraíble y palanca medical

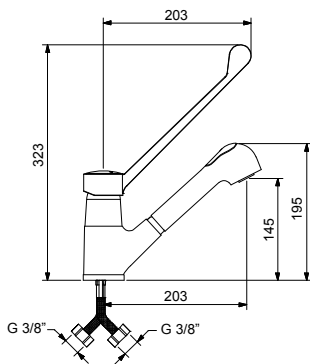

ART.	FINISHING	PACK.
09497	CHROME	1

09401

Doccetta per gruppi di prelavaggio
 Shower hand for pre-rinse shower
 Douchette pour douches de pré-lavage
 Teleducha para columnas ducha de prelavado

**GREENFLOW**

Greenflow è un getto ad alta pressione e basso consumo studiato per limitare gli spechi d'acqua e rimuovere le incrostazioni, stampato in materiale tecnico resistente alle alte temperature.

Greenflow it is a high-pressure, low-consumption jet designed to limit water waste and remove encrustations, moulded in technical material resistant to high temperatures.

Greenflow est un jet haute pression et basse consommation conçu pour limiter le gaspillage d'eau et éliminer les incrustations, moulé dans une matière technique résistante aux hautes températures.

Greenflow es un chorro de alta presión y bajo consumo diseñado para limitar el desperdicio de agua y eliminar incrustaciones, moldeado en material técnico resistente a altas temperaturas.

ART.	FINISHING	PACK.
09401	BLACK	1

**09400**

Gruppo doccia prelavaggio stoviglie H=900 mm. Per installazione su rubinetti/miscelatori
 Pre-rinse shower H=900 mm. For installation on mixers/taps

Douche de pré lavage H=900 mm. Pour installation sur robinets/mitigeurs

Columna ducha para prelavado vajillas H=900. Para instalación sobre grifos/mezcladores

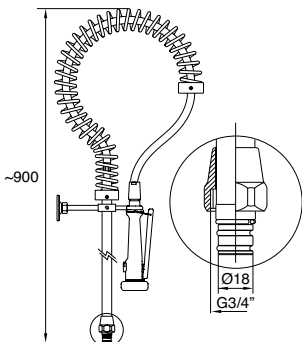

ART.
09400

FINISHING
CHROME

PACK.
1

**09410**

Gruppo doccia prelavaggio stoviglie H=1200 mm. Per installazione su rubinetti/miscelatori
 Pre-rinse shower H=1200 mm. For installation on mixers/taps

Douche de pré lavage H=1200 mm. Pour installation sur robinets/mitigeurs

Columna ducha para prelavado vajillas H=1200. Para instalación sobre grifos/mezcladores

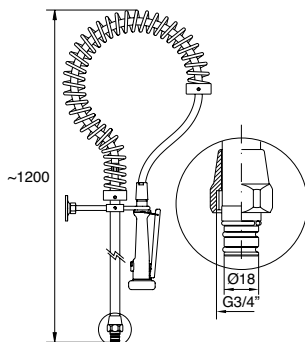

ART.
09410

FINISHING
CHROME

PACK.
1

**09420**

Gruppo doccia prelavaggio stoviglie H=1200mm con rubinetto a metà tubo. Per installazione su rubinetti/miscelatori

Pre-rinse shower unit H=1200mm with tap in the middle of the tube. For installation on mixers/taps

Douche de pré lavage H=1200 mm avec robinet à mi-tube. Pour installation sur robinets/mitigeurs

Columna ducha para prelavado vajillas H=1200 con grifo a mitad del tubo. Para instalación sobre grifos/mezcladores

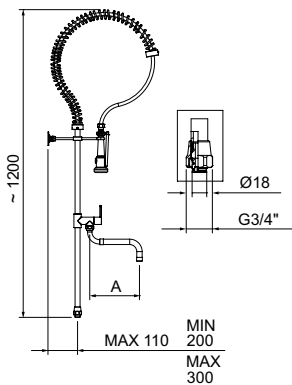

ART.
09420

FINISHING
CHROME

PACK.
1

**09425**

Gruppo doccia prelavaggio stoviglie H=900mm con rubinetto a metà tubo. Per installazione su rubinetti/miscelatori

Pre-rinse shower unit H=900mm with tap in the middle of the tube. For installation on mixers/taps

Douche de pré lavage H=900 mm avec robinet à mi-tube. Pour installation sur robinets/mitigeurs

Columna ducha para prelavado vajillas H=900 con grifo a mitad del tubo. Para instalación sobre grifos/mezcladores

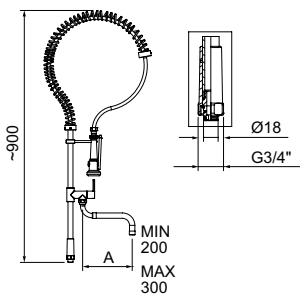

ART.
09425

FINISHING
CHROME

PACK.
1



KPR25/90

Kit gruppo doccia prelavaggio art. 09425 + miscelatore art. 09490

Kit pre-rinse shower art. 09425 + mixer art. 09490

Ensemble douche de prélavage art. 09425 + mitigeur art. 09490

Conjunto grupo ducha de prelavado art. 09425 + mezclador art. 09490

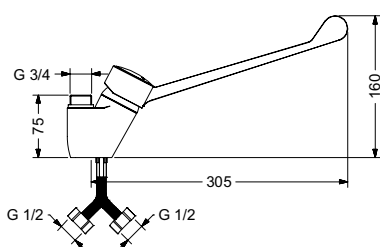
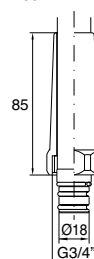
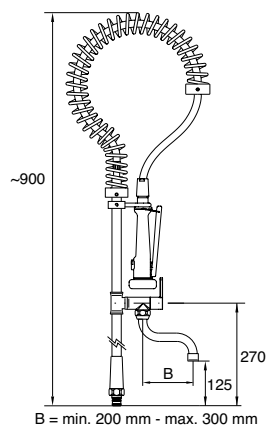

ART.
KPR25/90

FINISHING
CHROME

PACK.
1

**KPR00/80**

Kit gruppo doccia prelavaggio art. 09400 + miscelatore art. 09480

Kit pre-rinse shower art. 09400 + mixer art. 09480

Ensemble douche de pré-lavage art. 09400 + mitigeur art. 09480

Conjunto grupo ducha de prelavado art. 09400 + mezclador art. 09480

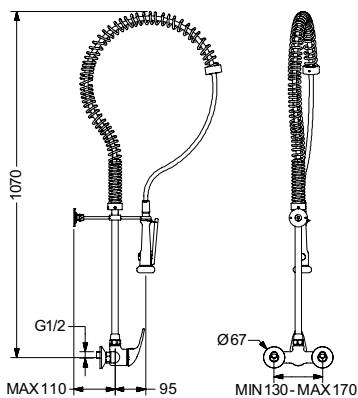

ART.

KPR00/80

FINISHING

CHROME

PACK.

1

**KPRO0-240/42**

Kit miscelatore alta portata art. 09442/LDC + canna girevole 09500-240

Kit including high flow mixer art. 09442/LDC + swivel spout art. 09500-240

Ensemble mitigeur à débit élevé art. 09442/LDC + bec mobile art. 09500-240

Conjunto mezclador con caudal elevado art. 09442/LDC + caño giratorio art. 09500-240

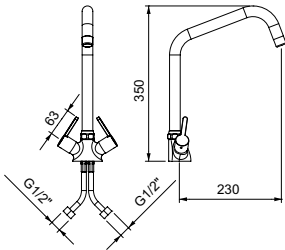

ART.	FINISHING	PACK.
KPRO0-240/42	CHROME	1

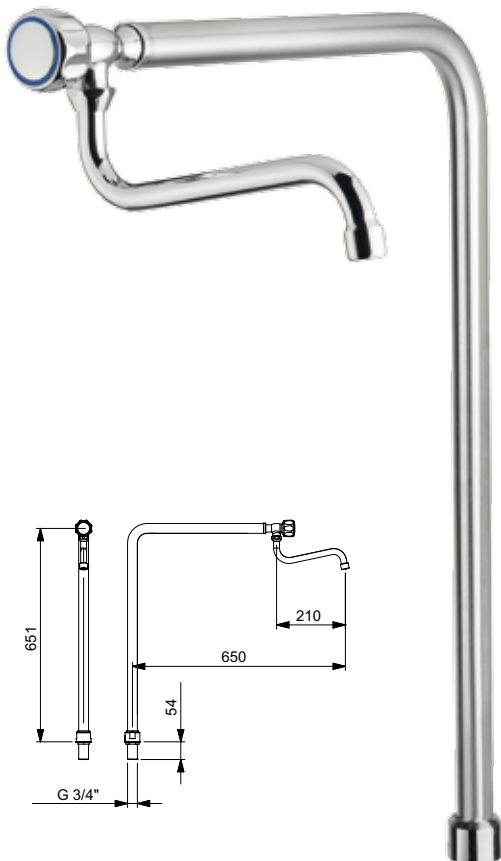
**09463**

Rubinetto orientabile per piano cottura con canna girevole

Swivelling tap for hob with swivelling spout

Robinet orientable pour plan de cuisson avec bec mobile

Grifo orientable para plano de cocción con caño giratorio de descarga

ART.	FINISHING	PACK.
09463	CHROME	1

**09150/0**

Lavello inox per montaggio a parete
 Stainless steel sink for wall mounting
 Lave-mains inox pour fixation murale
 Fregadero en acero inox para fijación a pared



08140SP - P. 124



02024 - P. 131



02506 - P. 233

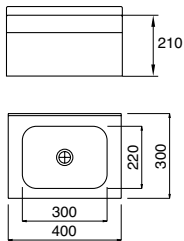

ART.	FINISHING	PACK.
09150/0	CHROME	1

**09160/0**

Lavello inox per montaggio a parete
 Stainless steel sink for wall mounting
 Lave-mains inox pour fixation murale
 Fregadero en acero inox para fijación a pared



08140SP - P. 124



02024 - P. 131



02506 - P. 233

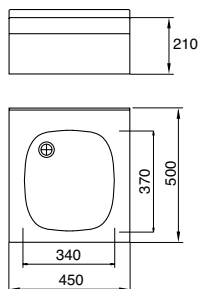

ART.	FINISHING	PACK.
09160/0	CHROME	1



accessori

**0415-15**

Sifone lavabo telescopico cromato 1"1/4
 Telescopic chromed basin siphon 1"1/4
 Siphon de lavabo extensible chrome 1"1/4
 Sifón telescópico cromado 1"1/4

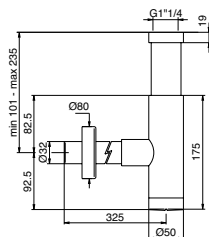

ART.	FINISHING	PACK.
0415-15	CHROME	1

**0195/1**

Rubinetto di arresto sottolavabo con filtro estraibile
 Check valve with extractable filter
 Robinet d'arrêt sous-lavabo avec filtre extractible
 Llave de paso bajo lavabo con filtro amovible

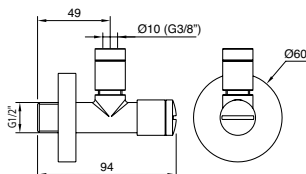

ART.	FINISHING	PACK.
0195/1	CHROME	1

**0400DI**

Distanziale in ABS cromo da 30mm per pilette
 Chrome ABS spacer 30 mm for drains
 Entretoise en ABS chromé 30 mm pour bondes de vidage
 Distanciador en ABS cromado 30 mm para válvulas de desagüe

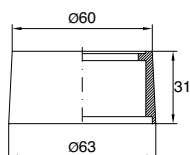

ART.	FINISHING	PACK.
0400DI	CHROME	1



0418

Piletta 1"1/4 con scarico automatico. Con troppo pieno
Automatic pop-up drain 1"1/4 With overflow
 Bonde 1"1/4 avec vidage automatique et trop-plein
 Válvula de desagüe automática 1"1/4 con rebosadero

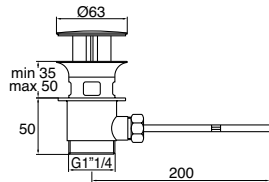

ART.	FINISHING	PACK.
0418	CHROME	1



0424/1

Piletta cromo 1"1/4 universale, con chiusura a scatto
Click-clack universal drain 1"1/4, chrome plated
 Bonde de vidage universelle 1"1/4, modèle clic-clac
 Válvula de desagüe 1"1/4 universal con cierre de resorte

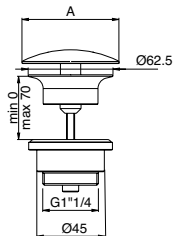

ART.	FINISHING	PACK.
0424/1	CHROME	1



0419

Piletta 1"1/4 con troppo pieno e chiusura a scatto
Click-clack drain 1"1/4 with overflow
 Bonde de vidage 1"1/4 clic-clac avec trop-plein
 Válvula de desagüe 1"1/4 con cierre de resorte y rebosadero

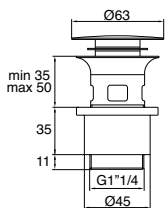

ART.	FINISHING	PACK.
0419	CHROME	1
0419/1		1

0419/1

Senza troppo pieno
Without over flow pipe
 Sans trop-plein
 Sin rebosadero



0418/2

Piletta 1"1/4 fissa, senza troppo pieno
Fixed drain 1"1/4 without overflow
 Bonde de vidage fixe 1"1/4, sans trop-plein
 Válvula de desagüe 1"1/4 fija sin rebosadero

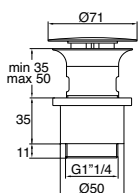

ART.	FINISHING	PACK.
0418/2	CHROME	1



0137M12

Rubinetto per contatore acqua con maniglia 1/2"
 Tap for water meter with handle 1/2"
 Robinet pour compteur d'eau avec poignée 1/2"
 Grifo para contador de agua con pomo 1/2"

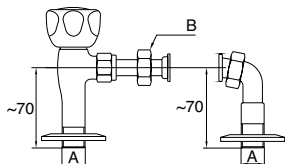

ART.	FINISHING	PACK.
0137M12	CHROME	5



0164/2-12

Rubinetto a sfera 1/2" per lavatrice
 Bib cock 1/2" for washing machine
 Robinet à sphère 1/2" pour lave-linge
 Grifo de bola 1/2" para lavadora

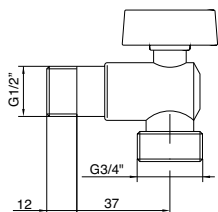

0164/2-38

Versione 3/8"
 3/8" version
 Version 3/8"
 Versión 3/8"

ART.	FINISHING	PACK.
0164/2-12	CHROME	10
0164/2-38	CHROME	10



0188

Rubinetto a sfera per monofori
 Angle ball check valve
 Robinet pour monotrou
 Grifo a bola para monoagujero

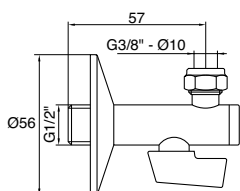

ART.	FINISHING	PACK.
0188	CHROME	10

**0188/1**

Rubinetto a sfera per monofori con snodo
 Angle ball check valve with swivel
 Robinet pour monotrou avec jonction
 Grifo a bola para monoagujero con unión

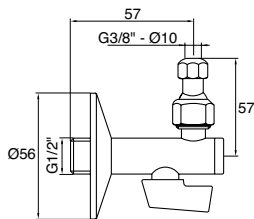

ART.	FINISHING	PACK.
0188/1	CHROME	10

**0194**

Rubinetto combinato per lavatrice e sottolavabo con calotta alta
 Double angle valve for washing machine and feeding under basin with high nut
 Robinet pour lave-linge et sous lavabo avec écrou haut
 Grifo para lavadora y bajo lavabo con tuerca alta

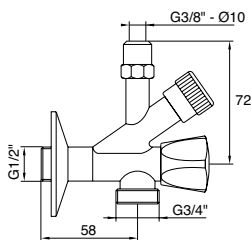

ART.	FINISHING	PACK.
0194	CHROME	2

**0165M12**

Rubinetto d'arresto
 Check valve
 Robinet d'arrêt
 Llave de paso

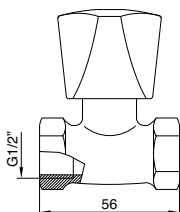

ART.	FINISHING	PACK.
0165M12	CHROME	2

**0167M12**

Rubinetto con attacco 3/4" per lavatrice

Tap for washing machine 3/4"

Robinet pour lave-linge con. 3/4"

Grifo para lavadora con. 3/4"

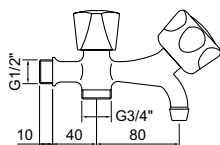

ART.	FINISHING	PACK.
0167M12	CHROME	2

**0168**

Raccordo pesante retrogruppo completo di rubinetto per lavatrice 3/4"

Unions for mixer with tap for washing machine 3/4"

Raccord avec robinet pour lave-linge 3/4"

Racor con grifo para lavadora 3/4"

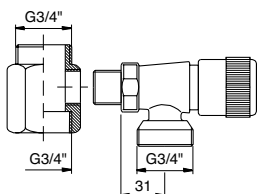

ART.	FINISHING	PACK.
0168	CHROME	4

**0176**

Gruppetto per scaldabagno

Mixer for water heater

Mitigeur pour chauffe-eau

Mezclador para calentador de agua

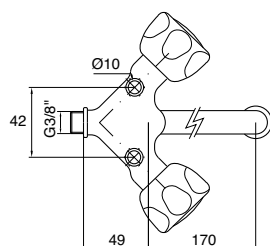

ART.	FINISHING	PACK.
0176	CHROME	2



0182C38x38

Rubinetto a squadra cromato F 3/8"
 Angle check valve F 3/8"
 Robinet équerre F 3/8"
 Grifo escuadra H 3/8"

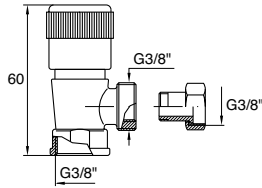

ART.	FINISHING	PACK.
0182C38x38	CHROME	10



0183

Rubinetto a squadra cromato
 Angle check valve
 Robinet équerre
 Grifo escuadra

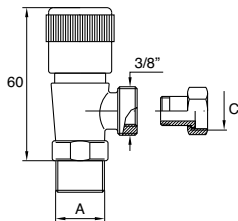

ART.	FINISHING	A	B	PACK.
0183C38x38	CHROME	3/8"	3/8"	10
0183C12x38	CHROME	1/2"	3/8"	10
0183C12x12	CHROME	1/2"	1/2"	10



053

Tappo copriforo Ø43
 Cover plug Ø43
 Bouchon de trou Ø43
 Tapón de tapa Ø43

053-50

Tappo copriforo Ø50
 Cover plug Ø50
 Bouchon de trou Ø50
 Tapón de tapa Ø50

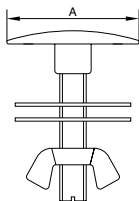

ART.	FINISHING	A	PACK.
053	CHROME	Ø43	10
053-50	CHROME	Ø50	10



080

Prolunga cromata
 Chrome plated extension
 Extension chromée
 Prolongador cromado

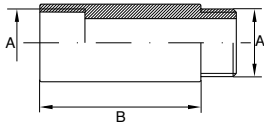

ART.	FINISHING	A	B	PACK.
080C12x10	CHROME	1/2"	10	10
080C12x15	CHROME	1/2"	15	10
080C12x20	CHROME	1/2"	20	10
080C12x30	CHROME	1/2"	30	10
080C12x40	CHROME	1/2"	40	10



081

Raccordo di riduzione
 Male-female diminishing
 Extension réduite chromée
 Reducción de conexión cromada

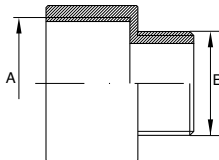

ART.	FINISHING	A	B	PACK.
081C12x38	CHROME	1/2"	10	10
081C34x12	CHROME	1/2"	15	10



086

Nipples a doppia vite con esagono
 Double nipple-connector
 Mamelon double raccord à vis hexagonal
 Niple hexagonal doble tornillo

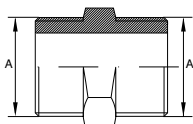

ART.	FINISHING	PACK.
086C38	CHROME	10
086C12	CHROME	10
086C34	CHROME	10



086/1

Nipples a riduzione con esagono
 Diminishing nipple
 Mamelon réduit hexagonal
 Niple reducción hexagonal

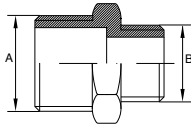

ART.	A	B	PACK.
086/1C12x38	1/2"	3/8"	10
086/1C34x12	3/4"	1/2"	10



088C12

Gomito FF
 FF elbow
 Coude FF
 Codo FF

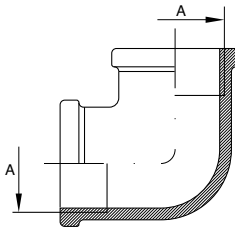

ART.	PACK.
088C12	10



095/1C12x34

Eccentrico a due pezzi con rosone
 S coupling
 Eccentrique à deux pièces
 Excentrico de dos piezas

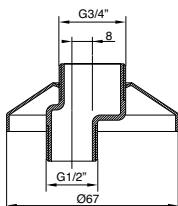

ART.	PACK.
095/1C12x34	2

**005/PN-BR**

Rubinetto per fontane con portagomma. Finitura bronzo spazzolato
 Tap for fountains with hose fitting. Brushed bronze finish
 Robinet pour fontaine avec porte-tuyau. Finition en bronze brossé
 Grifo para fuentes con porta-manguera. Acabado bronce cepillado

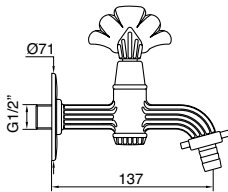

ART.	FINISHING	PACK.
005/PN-BR	BRONZE	1

**0156G12**

Rubinetto per fontane a pulsante con chiusura istantanea. Giallo lucido
 Push button tap for fountains, instantaneous shut-off. Polished yellow
 Robinet à poussoir pour fontaine, fermeture instantanée. Laiton poli
 Grifo con pulsador para fuentes, cierre instantáneo. Amarillo pulido

0156C12

Rubinetto per fontane a pulsante con chiusura istantanea. Cromo lucido
 Push button tap for fountains, instantaneous shut-off. Polished chrome
 Robinet à poussoir pour fontaine, fermeture instantanée. Chrome poli
 Grifo con pulsador para fuentes, cierre instantáneo. Cromado pulido

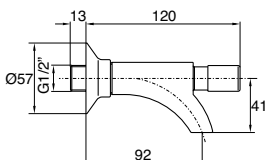

ART.	FINISHING	PACK.
0156G12	POLISHED	1
0156C12	CHROME	1



0151G12

Rubinetto portagomma giallo lucido
 Yellow polished hose fitting tap
 Robinet porte-tuyau laiton brut brillant
 Grifo portamanguera amarillo pulido

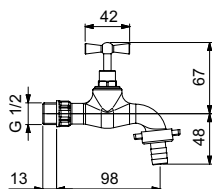

ART.	FINISHING	PACK.
0151G12	POLISHED	1
0254PU	POLISHED	10



0152G12

Rubinetto portagomma giallo lucido. A chiave levabile
 Yellow polished hose fitting tap. With removable key
 Robinet porte-tuyau laiton brut brillant. Avec clé extractible
 Grifo portamanguera amarillo pulido. Con llave amovible

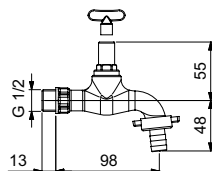
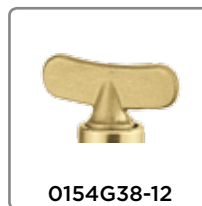

ART.	FINISHING	PACK.
0152G12	POLISHED	1
0154G38-12	POLISHED	1
0254PU	POLISHED	10

**09035/1**

Raccordo in ottone cromato MF 1/2" con limitatore di portata 7 l/min

Chromed brass MF fitting 1/2" with 7 l/min flow limiter

Raccord Mx F 1/2" en laiton chromé avec limiteur de débit 7 l/min

Racor unión MF 1/2" latón cromado con limitador de caudal 7 l/min

09035/1-9

Raccordo in ottone cromato MF 1/2" con limitatore di portata 9 l/min

Chromed brass MF fitting 1/2" with 9 l/min flow limiter

Raccord Mx F 1/2" en laiton chromé avec limiteur de débit 9 l/min

Racor unión MF 1/2" latón cromado con limitador de caudal 9 l/min

09035/1-12

Raccordo in ottone cromato MF 1/2" con limitatore di portata 12 l/min

Chromed brass MF fitting 1/2" with 12 l/min flow limiter

Raccord Mx F 1/2" en laiton chromé avec limiteur de débit 12 l/min

Racor unión MF 1/2" latón cromado con limitador de caudal 12 l/min

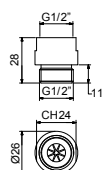
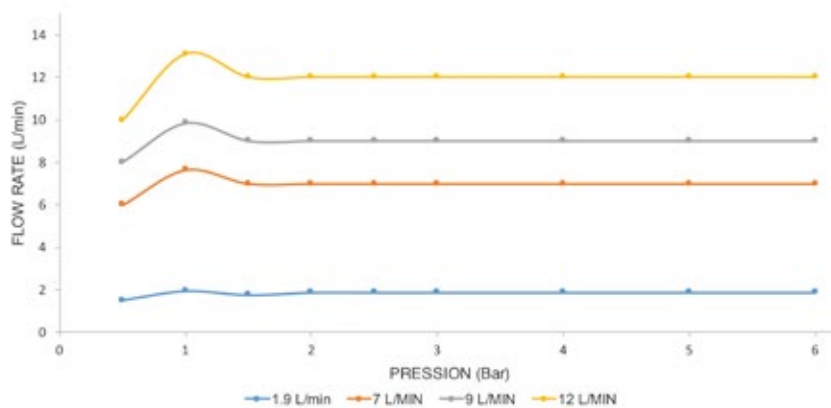

ART.

PACK.

09035/1

10

09035/1-9

10

09035/1-12

10

**KT01LD**

Kit limitazione portata M24x1 SLIM

Flow limiting kit M24x1 SLIM

Ensemble pour limitation débit d'eau M24x1 SLIM

Conjunto de limitación caudal de agua M24x1 SLIM

ART.	FLOW RATE	PACK.
KT01LD	1,9 l/min	1

**KT02LD**

Kit limitazione portata M24x1

Flow limiting kit M24x1

Ensemble pour limitation débit d'eau M24x1

Conjunto de limitación caudal de agua M24x1

ART.	FLOW RATE	PACK.
KT02LD	1,9 l/min	1

**KT03LD**

Kit limitazione portata M21,5x1 CACHÉ

Flow limiting kit M21,5x1 CACHÉ

Ensemble pour limitation débit d'eau M21,5x1 CACHÉ

Conjunto de limitación caudal de agua M21,5x1 CACHÉ

ART.	FLOW RATE	PACK.
KT03LD	1,9 l/min	1

**KT04LD**

Kit limitazione portata M21,5x1 CACHÉ

Flow limiting kit M21,5x1 CACHÉ

Ensemble pour limitation débit d'eau M21,5x1 CACHÉ

Conjunto de limitación caudal de agua M21,5x1 CACHÉ

ART.	FLOW RATE	PACK.
KT04LD	1,9 l/min	1

**KT05LD**

Kit limitazione portata M16x1 CACHÉ

Flow limiting kit M16x1 CACHÉ

Ensemble pour limitation débit d'eau M16x1 CACHÉ

Conjunto de limitación caudal de agua M16x1 CACHÉ

ART.	FLOW RATE	PACK.
KT05LD	1,9 l/min	1

**CHA18SL**

Chiave per aeratore SLIM 18x1 per art. 08010/E - 08011 - 08012
Key for aerator M18x1 "SLIM" for art. 08010/E - 08011 - 08012
Clé pour aérateur SLIM M18x1 pour art. 08010/E - 08011 - 08012
Llave para aireador M18x1 "SLIM" para art. 08010/E - 08011 - 08012

CHA21C

Chiave per aeratore CACHÉ M21, 5x1 per art. 02503 - 08112
Key for aerator M21, 5x1 "CACHÉ" for art. 02503 - 08112
Clé pour aérateur CACHE M21, 5x1 pour art. 02503 - 08112
Llave para aireador M21,5x1 "CACHÉ" para art. 02503 - 08112

CHA22AV

Chiave per aeratore antivandalo F22x1 per art. 02027
Key for vandal proof aerator F22x1 for art. 02027
Clé pour aérateur anti-vandalisme F22x1 pour art. 02027
Llave para aireador F22x1 antivandalico para art. 02027

CHA24C

Chiave per aeratore SLIM / CACHE' M24x1 per art. 02504 - 02506 - 02026 - 02535
Key for aerator M24x1 "SLIM - CACHÉ" for art. 02504 - 02506 - 02026 - 02535
Clé pour aérateur SLIM/CACHE M24x1 pour art. 02504 - 02506 - 02026 - 02535
Llave para aireador M24x1 "SLIM - CACHÉ" para art. 02504 - 02506 - 02026 - 02535

ART.	PACK.
CHA18SL	1
CHA21SL	1
CHA22AV	1
CHA24C	1



ZESNX-03000

Espositore a "L" in cartone
"L" cardboard display
Présentoir "L" en carton
Expositor a "L" de cartón

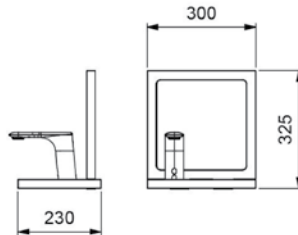

ART.
ZESNX-03000

PACK.
1



ZESNX-04000

Espositore a totem con 6 ripiani
Totem display with 6 shelves
Présentoir totem avec 6 étagères
Expositor tótem con 6 estantes

ART.
ZESNX-04000

PACK.
1



NR.	ART.	APPLICATION	PACK
1	02085	02061 - 02064 - 02066 - 02068	5
2	02089	02061 - 02064 - 02066 - 02068	5
3	02083	02061 - 02064 - 02066 - 02068	5
4	02087	02061 - 02064 - 02066 - 02068	5
5	02097 PES	02061 - 02064 - 02066 - 02068 - 02070 - 02072/90 - 02075/01	10
6	02098	02061 - 02064 - 02066 - 02068 - 02070 - 02072/90 - 02075/01	10
7	02096/CR - 02096/CB - 02096/CN	02061 - 02064 - 02066 - 02068 - 02070 - 02072/90 - 02075/01	6
8	02066-61LVCOMB - 02066-61LVCOMR	02061 - 02064 - 02066 - 02068 - 02070 - 02072/90 - 02075/01	1
9	02068-64LVCOMB - 02068-64LVCOMR	02061 - 02064 - 02066 - 02068 - 02070 - 02072/90 - 02075/01	1
10	02075VR	02070 - 02072/90 - 02075/01	5
11	02096/F	02061 - 02064 - 02066 - 02068 - 02070 - 02072/90 - 02075/01	20
12	02092	02070 - 02072/90 - 02075/01	5
13	02095	02070 - 02072/90 - 02075/01	5
14	02091C	02070 - 02072/90 - 02075/01	5
15	02091F	02070 - 02072/90 - 02075/01	5
16	02093	02070 - 02072/90 - 02075/01	5
17	02094	02070 - 02072/90 - 02075/01	5
18	02075/01BLCOM	02075/01	1

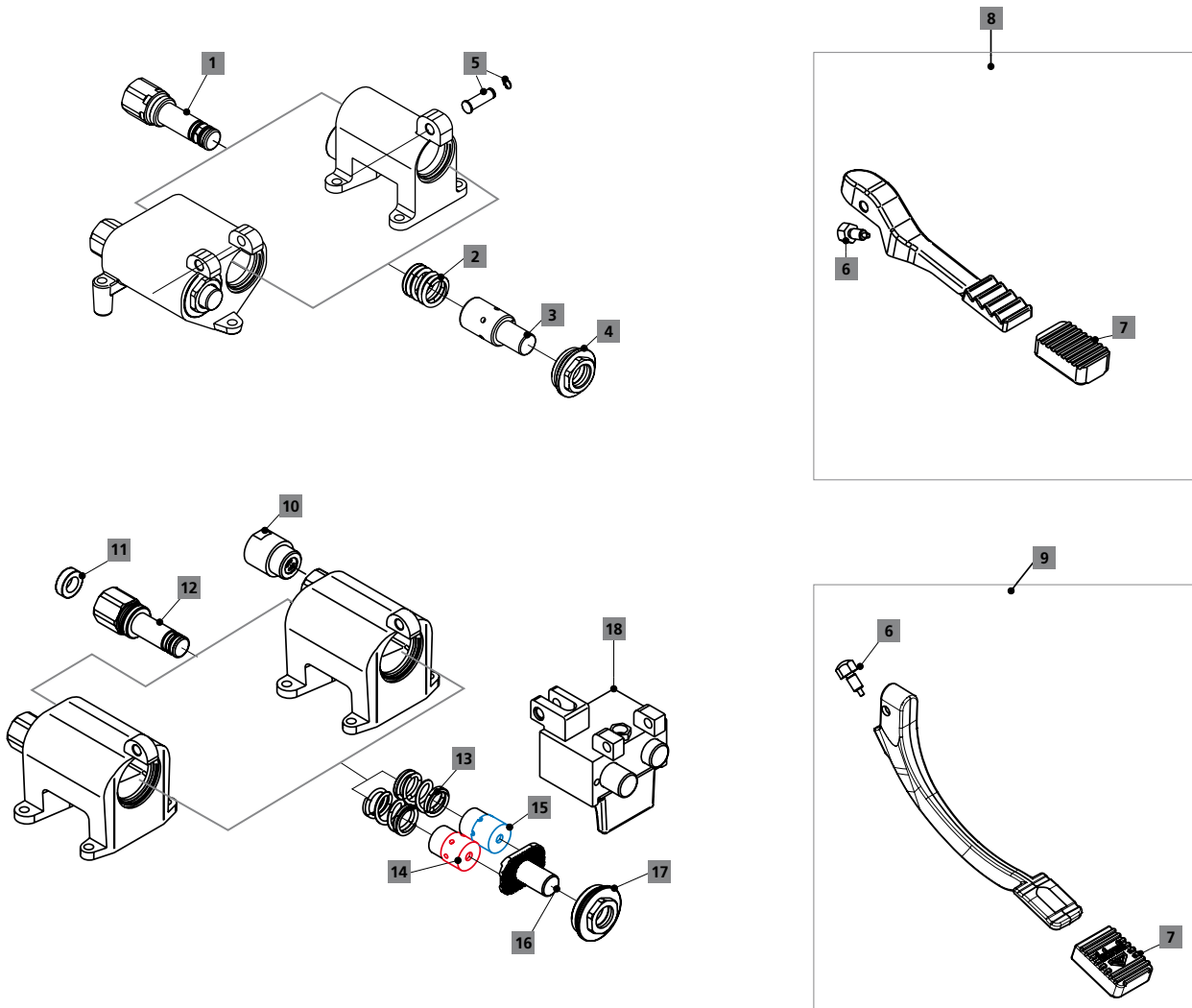



ACCESSORI | ACCESSORIES | ACCESSOIRES | ACCESORIOS



ART.	APPLICATION	TIMING AT 3 BAR
08055/E	08000/E - 08010/E - 08010/EPM - 08015/E	15 sec.
08055/EH	08012	15 sec.
08055/E-8	08020/E - 08020/1E	8 sec.



09050-09050

ART.	APPLICATION	TIMING AT 3 BAR
09050	08000 - 08010 - 08015 - 08020-15 - 08140SP - 800.12 - 845.10 - 700.B4/1 7DCM3-00000	15 sec.
09050/H	08132 - 08133 - 08135 - 08135-140 - 08136 - 08142 - 08142/1 - 08112 - 845.12 700.B2/1 - 700A2/1 - 08137 - TMIM4-00000 - TMIM4-04000	15 sec.
09050/H-30	08132-30 - 08133-30 - 08142-30 - 01842/1-30 - 700.A2/1-30 - TDCM3-01000	25 sec.



ART.	APPLICATION	TIMING AT 3 BAR
08101VT	08101 - 08111	15 sec.
08155/E	08130/E - 08140/E - 09200 - 08120-15 - 09220 - 09224	15 sec.
08155/E-8	08125 - 08120/E - 08120/1E	8 sec.
08155/E-30	08120-30 - 08130/E-30 - 08140/E-30	25 sec.
08210VT	08200 - 08210 - 08210/PM	15 sec.
08210VT/H	08212 - 09011 - 09022	15 sec.
08250VTA	08250	15 sec.



09061

ART.	APPLICATION	TIMING AT 3 BAR
09065	08145 - 08150 - 09020 - 02115/PR	15 sec.
09065I	02115	15 sec.
09061	08001A - 08011A - 08011A/PM - 08016A - 08145A - 09030/1I	15 sec.
09061/H	08013A - 09020A	15 sec.
09061-30	09030/1 - 09030/1S	25 sec.



08555



08545

ART.	APPLICATION	TIMING AT 3 BAR
08555	08500 - 08510 - 08510/PM - 08512	0-30 sec. (preset 15 sec.)
08555/D	08530/E	0-30 sec. (preset 25 sec.)
08545	08540/E	0-30 sec. (preset 25 sec.)
08557	08512F - 08510F - 08510F/PM - 08500F - 08530/EF	15 sec.
08557-30	08530/E-30F	15 sec.
08558/H	700.B2/1F - 700.A2/1F - 08533F - 08532F - 08537F - 08542F - 08542MF	15 sec.
08558/H-30	700.A2/1F-30 - 08533-30F - 08532-30F - 08537-30F - 08542-0F - 08542/1-30F	15 sec.
08546	08540/EF	15 sec.
08546-30	08540/E-30F	15 sec.



Z01RX-81000



08400VT

ART.	APPLICATION	TIMING AT 3 BAR
Z01RX-81000	800.10 - 800.00 - 800.00-150	15 sec.
08400VT	08410 - 08400	15 sec.
08400VT-8	08420/1	15 sec.
Z84RX-00000	08425	15 sec.
08440VT	08440 - 08430 - 08420-15	15 sec.
08440VT-30	08440-30 - 08430-30 - 08420-30	15 sec.



09056



09057VT

ART.	APPLICATION	TIMING AT 3 BAR
09056	08061-1 - 08061-34 - 08066-1 - 08066-34	6 sec.
09057VT	08067-34 - 08067-1	6 sec.



09058

ART.	APPLICATION	TIMING AT 3 BAR
09058	09290	25 sec.



ART.



ART.



ART.



005/PN-BR



0150/DC



0162M12



01160/DC



0151G12



0163M12



01161/DC



0152G12



0164/2



01210



0153



0165



01210/PT



0154G38-12



0167



01212



0156C12



0168



01220



0156G12

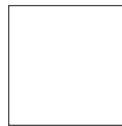

0176



01221



0159/1

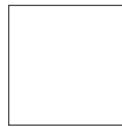

0178



01250



0159/86



0182



01250/PT



0160M12



0183



0137



0161M12



0188





ART.



0188/1



0194



0195/1



02001/DC



02010/DC



02024



02025



02026



02030



02050/DC



02058



ART.



02058/1



02061



02064



02066



02068



02070



02072/90



02075/01



02079/4



02102



02115/PR



ART.



02130



02140



02150



02152



02152-B



02178



02179L30



02179P25



0230



0236



02400





ART.



02400/LN



02404



02404/LN



02405/LN



02405DOC



02405FLEX



02419/C



02419/CDOC



02419/CFLEX



02427/S



02450



ART.



02450/LN



02451



02451/LN



02475



02475/LN



02477



02503/1



02503/1-A



02503/1PM



02503/1PM-A



02503/1PT



ART.



02503/1PT-A



02503/1R



02503/1R-A



02503/1RPM



02503/1RPM-A



02503/1RPT



02503/1RPT-A



02503/1S



02504



02504-A



02504/1





ART.



02504/1R



02504/R



02504/R-A



02505



02505/R



02506



02506/R



02511



02511/PM



02511/PT



02511/R



ART.



02511/RPM



02511/RPT



02512



02512/R



02520/1



02521



02521/1



02521/1R



02521/R



02524



02524/R



ART.



02530



02530/1



02530/1R



02530/R



02532



02532/1



02532/1R



02532/R



02535



0254-BR



02540





ART.



ART.



ART.



02540/1



02552/1-140



02650/2



02540/1R



02565/1R



02650/3



02540/R



02565/R



0400DI



02542



02580



0415



02542/1



02580/R



0415-15



02542/1R



02582



0416



02542/R



02582/R



0418



0254PU



02582S



0418/2



02550



02584



0419



02550-140



02584/R



0424/1



02552/1



02605



050C114



SCHEDE TECNICHE
DATA SHEET



RICAMBI
SPARE PARTS



ART.



051C1



051C114



053



053-50



057



057/1



080



08000/E



08001A



08010/E



08010/EPM



ART.



08011A



08011A/PM



08012



08013A



08015/E



08016A



08020/1E



08020/E



08060/1-1



08060/1-34



08060/1TB1



ART.



08060/1TB34



08065TBK



08066-1



08066-34



08067-1



08067-34



081



081/1



08112



08120-15



08120-30



SCHEDE TECNICHE
DATA SHEET



RICAMBI
SPARE PARTS



ART.



08120/1E



08120/E



08125



08130/E



08130/E-30



08132



08132-30



08133



08133-30



08135



08135-140



ART.



08136



08137



08137-30



08140/E



08140/E-30



08140/SP



08142



08142-30



08142/1



08142/1-30



08145A



ART.



082



08200



08210



08210/PM



08212



08250



083



08400



08410



08420-15



08420-30



SCHEDE TECNICHE
DATA SHEET



RICAMBI
SPARE PARTS



ART.



08420/1



08425



08430



08430-30



08431



08431/1



08440



08440-30



08500



08500F



08510



ART.



08510/PM



08510F



08510F/PM



085112F



08512



08512F



08530/E



08530/E-30F



08532-30F



08532F



08533-30F



ART.



08533F



08537-30F



08537F



08540/E



08540/E-30F



08540/EF



08542-30F



08542/1-30F



08542/1F



08542F



086



SCHEDE TECNICHE
DATA SHEET



RICAMBI
SPARE PARTS



ART.



086/1



08633-20



08640-20



08651-20



08666-34-20



088



089



090



09024/D



09024/DC



09024DOC



ART.



09024FLEX



09026/1



09027-1



09027-34



09028.1-12



09028.1-34



09029



09030/1



09030/1CU12



09030/1I



09030/1S



ART.



09031



09031/1



09031/E



09031KT20



09031KT32



09033



09033/1



09036



09036KT20



09036KT32



09071



SCHEDE TECNICHE
DATA SHEET



RICAMBI
SPARE PARTS



ART.



09072



09073



09150/0



09160/0



09212



09212-30



09220



09220/L



09224



09231



09231/L



ART.



09260



09261



09270



09271



09290



09400



09410



09420



09425



09426/03



09426/03L



ART.



09430



09435



09440/DC



09440/LDC



09442/DC



09442/LDC



09450/DC



09450/LDC



09455/DC



09455/LDC



09463



SCHEDE TECNICHE
DATA SHEET



RICAMBI
SPARE PARTS



ART.



09470/DC



09470/LDC



09480



09485



09488



09490



09495



09497



095/1



09500-350



09500SE



ART.



10191



10191PLT



10192



10192PLT



10200



10200PLT



10205



10207



10210



10210PLT



10215



ART.



10242



10246



10262



10266



10272



10276



10282



10286



10302



10306



10316



SCHEDE TECNICHE
DATA SHEET



RICAMBI
SPARE PARTS



ART.			ART.			ART.		
10381			10580			12001IS-SX		
10386			11200			12001V-DX		
10395			11200/C			12001V-SX		
10395/1			11200/E			12002V		
10396			11300			12003V-PP		
10396PSF			11301			12003V-PT		
10396PSL			11306			12004V-DX		
10560			11306B			12004V-SX		
10565			12000IS			12005IS		
10575			12000V			12005V		
10575/E			12001IS-DX			12006V		



ART.



12007.1



12007.2



12008/1V



12008/2V



12008IS



12008V



12010/1V



12010/I



12010IS



12010V



12013IS



ART.



12013V



12014



12014S



12015

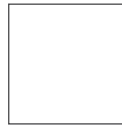

12600



15100



15101



15102



15105/2



15105/2-CG



15106-CG



ART.



15107



15107-CG



15200



15201



15402/2



15404



15405



15407



15408



15409/4



15410



SCHEDE TECNICHE
DATA SHEET



RICAMBI
SPARE PARTS



ART.



15411



15412



15501.1



15501.2



15504.1



15506.1



15507.1



15600



500.10



500.10-150



500.10-150/PM



ART.



500.10-150/PT



500.10-150/R



500.10-150/RPM



500.10-150/RPT



500.10/PM



500.10/PT



500.10/R



500.10/RPM



500.10/RPT



500.12



500.12-150



ART.



500.12-150/R



500.12/R



545.10



545.10/R



545.12



545.12/R



551



551.10



551.20



551.30



560.10



SCHEDE TECNICHE
DATA SHEET



RICAMBI
SPARE PARTS



ART.



560.20



560.30



560.K3



700.A1/1



700.A2/1



700.A2/1-30



700.A2/1F



700.A2/1F-30



700.A3/1



700.A3/1R



700.A4/1



ART.



700.A4/1R



700.A5/1



700.A5/1R



700.A6



700.A6/R



700.A7/R



700.A8



700.A8/1



700.A8/1R



700.A8/R



700.A9



ART.



700.A9/1



700.A9/1R



700.A9/R



700.B1/1



700.B2/1



700.B2/1F



700.B3/1



700.B4/1



700.B8/R



800.00



800.00/15



SCHEDE TECNICHE
DATA SHEET



RICAMBI
SPARE PARTS



ART.



800.10



800.10-A



800.12



800.12-A



845.10



845.12



900.12



900.12-A



900.16



900.24



900.24/M



ART.



900.25



900.25-A



900.32



900.35



900.35-140



900.37



900.39-240



900.42



900.42/1



900.92



908.12



ART.



908.32



908.35



908.35-140



908.37



908.42



908.42/1



908.92



HLICX-04000



HLICX-05000



HLICX-06000



HLICX-07000



SCHEDE TECNICHE
DATA SHEET



RICAMBI
SPARE PARTS



ART.



HLICX-08000



HLICX-09000



170M2-00000



170M2-01000



170M2-02000



170M2-03000



170M2-04000



170M2-05000



170M4-00000



170M4-01000



170N2-00000



ART.



170N2-01000



170N2-02000



170N2-03000



170N2-04000



170N2-05000



170N4-00000



170N4-01000



170N8-00000



170N8-01000



184M0-00000



184M0-01000



ART.



184M2-00000



184M2-01000



184M2-02000



184M2-03000



184M4-00000



184M4-01000



184N0-01000



184N0-02000



184N2-00000



184N2-01000



184N2-02000



SCHEDE TECNICHE
DATA SHEET



RICAMBI
SPARE PARTS



ART.



184N2-03000



184N4-00000



184N4-01000



190H3-00000



190H3-01000



KFL61/24



KFL66/25



KFL70/26



KPR00-240/42



KPR00/80



KPR25/90



ART.



KSA20/31



KSA20/31-30



KSA20/36



KSA20/36-30



KSA32/31



KSA32/31-30



KSA32/36



KSA32/36-30



L90H3-00000



M84DX-00000



M84M0-00000



ART.



M84M0-01000



M84M2-00000



M84M4-00000



M90H3-00000



M90H4-00000



M90H4-01000



T98H3-00000



T98H4-00000



T98H4-01000



TDCM3-00000



TDCM3-01000



SCHEDE TECNICHE
DATA SHEET



RICAMBI
SPARE PARTS



ART.



ART.



TMIM4-00000



Z84CX-01000



TMIM4-01000



TMIM4-02000



TMIM4-03000



TMIM4-04000



TMIM4-05000



TMIM4-06000



TMIM4-07000



TMON8-00000



TMON8-01000



Z84CX-00000



SCHEDE TECNICHE
DATA SHEET



RICAMBI
SPARE PARTS



ART.	PAG.	ART.	PAG.	ART.	PAG.
005/PN-BR	268	02072/90	126	02505	99
01210	20	02075/01	128	02505/R	99
01210/PT	20	02075/01BLCOM	274	02506	233
01212	20	02075VR	274	02506/R	233
01220	21	02083	274	02511	97
01221	21	02085	274	02511/PM	97
01250	20	02087	274	02511/PT	97
01250/PT	20	02089	274	02511/R	97
0137M12	262	02091C	274	02511/RPM	97
0150/DC	136	02091F	274	02511/RPT	97
0151G12	269	02092	274	02512	96
0152G12	269	02093	274	02512/R	96
0153	135	02094	274	02520/1	199
0154G38-12	269	02095	274	02524	198
0156C12	268	02096/CB	274	02524/R	198
0156G12	268	02096/CN	274	02535	110
0159/86	135	02096/CR	274	0254	123
0160M12	136	02096/F	274	0254PU	269
0161M12	136	02097PES	274	02550	111
0162M12	137	02098	274	02550-140	111
0163M12	137	02102	134	02552/1	111
0164/2-12	262	02115/PR	128	02552/1-140	111
0164/2-38	262	02130	132	02582	108
0165M12	263	02150	150	02582/R	108
0167M12	264	02152	134	02582S	101
0168	264	02178	217	02584	108
0176	264	02179L30	217	02584/R	108
0178	135	02179P25	217	02605	159
0182C38X38	265	0230	201	02606	159
0183C12X12	265	0236	201	02650/2	87
0183C12X38	265	02400	149	02650/3	87
0183C38X38	265	02404	67	0400DI	260
0188	262	02404/LN	67	0415-15	260
0188/1	263	02405/LN	67	0418	261
0194	263	02405DOC	69	0418/2	261
0195/1	260	02405FLEX	69	0419	261
02001/DC	151	02419/C	68	0419/1	261
02010/DC	151	02419/CDOC	68	0424/1	261
02024	131	02419/CFLEX	68	053	265
02025	131	02427/S	68	053-50	265
02026	131	02450	150	08000/E	123
02027	133	02451	150	08001A	147
02027/E	133	02475	149	08010/E	119
02030	132	02475/LN	149	08010/EPM	119
02050/DC	151	02477	149	08011A	146
02058	142	02503/1	100	08011A/PM	146
02058/1	142	02503/1PM	100	08012	118
02061	127	02503/1PT	100	08013A	146
02064	127	02503/1R	100	08015/E	124
02066	125	02503/1RPM	100	08016A	147
02066-61LVCOMB	274	02503/1RPT	100	08020/1E	200
02066-61LVCOMR	274	02503/1S	101	08020/E	200
02068	125	02504	98	08055/E	275
02068-64LVCOMB	274	02504/1	98	08055/E-8	275
02068-64LVCOMR	274	02504/1R	98	08055/EH	275
02070	126	02504/R	98	08060/1-1	196



ART.	PAG.	ART.	PAG.	ART.	PAG.
08060/1-34	196	08400VT	275	086C34	266
08060/1TB1	196	08400VT-8	275	086C38	266
08060/1TB34	196	08410	209	088C12	267
08065TBK	196	08420-15	212	09024/D	69
08066-1	194	08420-30	212	09024/DC	69
08066-34	194	08420/1	210	09024/DV	69
08067-1	194	08425	210	09024DOC	69
08067-34	194	08430	211	09024FLEX	69
080C12X10	266	08430-30	211	09026/1	219
080C12X15	266	08431	212	09027-1	221
080C12X20	266	08431/1	212	09027-34	221
080C12X30	266	08440	211	09028.1-12	219
080C12X40	266	08440-30	211	09028.1-34	219
08101VT	275	08440VT	275	09029	219
08111	114	08440VT-30	275	09030/1	172
08112	114	08500	123	09030/1CU12	172
08120-15	170	08500F	123	09030/1I	172
08120-30	170	08510	117	09030/1S	172
08120/1E	200	08510/PM	117	09031	171
08120/E	200	08510F	117	09031/1	171
08125	201	08510F/PM	117	09031/E	178-179
08130/E	169	085112F	114	09031KT20	179
08130/E-30	169	08512	116	09031KT32	178
08132	164	08512F	116	09033	173
08132-30	164	08530/E	169	09033/1	173
08133	163	08530/E-30F	169	09035/1	270
08133-30	163	08530/EF	169	09035/1-12	270
08135	121	08532-30F	164	09035/1-9	270
08135-140	121	08532F	164	09036	173
08136	121	08533-30F	163	09036KT20	181
08137	165	08533F	163	09036KT32	180
08137-30	165	08537-30F	165	09050	275
08140/E	168	08537F	165	09050/H	275
08140/E-30	168	08540/E	168	09050/H-30	275
08140SP	124	08540/E-30F	168	09056	275
08142	166	08540/EF	168	09057VT	275
08142-30	166	08542-30F	166	09058	275
08142/1	167	08542/1-30F	167	09061	275
08142/1-30	167	08542/1F	167	09061-30	275
08145A	147	08542F	166	09061/H	275
08155/E	275	08545	275	09065	275
08155/E-30	275	08546	275	09065I	275
08155/E-8	275	08546-30	275	09071	166
081C12X38	266	08555	275	09072	168-201
081C34X12	266	08555/D	275	09073	194
08200	123	08557	275	09150/0	256
08210	116	08557-30	275	09160/0	256
08210/PM	116	08558/H	275	09220	183
08210VT	275	08558/H-30	275	09220/L	184
08210VT/H	275	086/1C12X38	267	09224	186
08212	116	086/1C34X12	267	09231	183
08250	119	08633-20	215	09231/L	184
08250VTA	275	08640-20	215	09260	188
08400	209	08651-20	215	09261	188
08400PRO-100	209-210-212	08666-34-20	215	09270	189
08400PRO-50	209-210-212	086C12	266	09271	189



ART.	PAG.	ART.	PAG.	ART.	PAG.
09290	176	10396	33	12010/I	53
09400	250	10396PSF	33	12010IS	53
09401	249	10396PSL	33	12010V	52
09410	251	10560	80	12013IS	43
09420	252	10565	80	12013V	43
09425	253	10575	81	12014	56
09426/03	235	10575/E	81	12014S	56
09426/03L	235	10580	82	12015	170
09430	133	11200	58	12600	201
09435	245	11200/C	58	15100	64
09440/DC	244	11200/E	58	15101	64
09440/LDC	244	11300	58	15102	64
09442/DC	244	11306	22	15105/2	63
09442/LDC	244	11306B	22	15105/2-CG	63
09450/DC	242	12000CV-ML	42	15106-CG	64
09450/LDC	243	12000IS-120	42	15107	62
09455/DC	242	12000IS-30	42	15107-CG	62
09455/LDC	243	12000IS-40	42	15200	57
09463	256	12000IS-60	42	15201	57
09470/DC	245	12000IS-90	42	15402/2	37-38
09470/LDC	245	12000V-120	42	15404	60
09480	240	12000V-150	42	15405	60
09485	240	12000V-180	42	15407	60
09488	248	12000V-200	42	15408	61
09490	240	12000V-30	42	15409/4	35-36-37
09495	248	12000V-45	42	15410	37-38-39
09497	249	12000V-50	42	15411	61
095/1C12X34	267	12000V-60	42	15412	61
09500-240	246	12000V-70	42	15501.2	54
09500-350	246	12000V-80	42	15504.1	55
09500SE	246	12000V-90	42	15506.1	54
10191	32	12001IS-DX	45	15507.1	55
10191PLT	32	12001IS-SX	45	15600	57
10192	32	12001V-DX	45	500.10	93
10192PLT	32	12001V-SX	45	500.10-150	94
10200	35	12002V-100	46	500.10-150/PM	94
10200PLT	35	12002V-65	46	500.10-150/PT	94
10205	36	12002V-75	46	500.10-150/R	94
10207	36	12003V-PP	44	500.10-150/RPM	94
10210	35	12003V-PT	44	500.10-150/RPT	94
10210PLT	35	12004V-65DX	46	500.10/PM	93
10215	36	12004V-65SX	46	500.10/PT	93
10242	37	12004V-85DX	46	500.10/R	93
10246	37	12004V-85SX	46	500.10/RPM	93
10262	40	12005IS-80	47	500.10/RPT	93
10266	40	12005V-70	47	500.12	92
10272	39	12005V-80	47	500.12-150	92
10276	39	12006V-70	48	500.12-150/R	92
10282	38	12006V-80	48	500.12/R	92
10286	38	12007.1	49	545.10	95
10302	23	12007.2	49	545.10/R	95
10306	23	12008/1V	50	545.12	95
10316	23	12008/2V	51	545.12/R	95
10392	22	12008IS	51	551	77
10395	33	12008V	50	551.10	76
10395/1	33	12010/1V	52	551.20	76



ART.	PAG.	ART.	PAG.	ART.	PAG.
551.30	76	908.42	162	I84N0-01000	205
560.10	78	908.42/1	162	I84N0-02000	205
560.20	78	CHA18SL	272	I84N2-00000	206
560.30	78	CHA21C	272	I84N2-01000	206
560.K3	79	CHA22AV	272	I84N2-02000	207
700.A1/1	159	CHA24C	272	I84N2-03000	207
700.A2/1	158	HLICX-02000	86	I84N4-00000	208
700.A2/1-30	158	HLICX-03000	86	I84N4-01000	208
700.A2/1F	158	HLICX-04000	85	I90H3-00000	160
700.A2/1F-30	158	HLICX-05000	85	I90H3-01000	160
700.A3/1	156	HLICX-06000	84	KFL61/24	129
700.A3/1R	156	HLICX-07000	84	KFL66/25	130
700.A4/1	156	HLICX-08000	83	KFL70/26	129
700.A4/1R	156	HLICX-09000	83	KPR00-240/42	256
700.A5/1	157	I55D0-00000	228	KPR00/80	255
700.A5/1R	157	I55D0-01000	228	KPR25/90	254
700.A6	199	I55D0-02000	230	KSA20/31	179
700.A6/R	199	I55D0-03000	230	KSA20/31-30	179
700.A7/R	192	I55D0-04000	228	KSA20/36	181
700.A8	103	I55D0-05000	228	KSA20/36-30	181
700.A8/1	103	I55D0-06000	230	KSA32/31	178
700.A8/1R	103	I55D0-07000	230	KSA32/31-30	178
700.A8/R	103	I55D0-08000	229	KSA32/36	180
700.A9	102	I55D0-09000	229	KSA32/36-30	180
700.A9/1	102	I55D0-10000	231	KT01LD	271
700.A9/1R	102	I55D0-11000	231	KT02LD	271
700.A9/R	102	I55D0-12000	229	KT03LD	271
700.B1/1	104	I55D0-13000	229	KT04LD	271
700.B2/1	104	I55D0-14000	231	KT05LD	271
700.B2/1F	104	I55D0-15000	231	L90H3-00000	145
700.B3/1	105	I70M2-00000	107	M84DX-00000	185
700.B4/1	105	I70M2-01000	107	M90H3-00000	145
700.B8/R	192	I70M2-02000	106	M90H4-00000	143
800.00	122	I70M2-03000	106	M90H4-01000	143
800.00/15	122	I70M2-04000	109	T98H3-00000	175
800.10	113	I70M2-05000	109	T98H4-00000	162
800.12	113	I70M4-00000	155	T98H4-01000	162
845.10	115	I70M4-01000	155	TDCM3-00000	174
845.12	115	I70N2-00000	107	TDCM3-01000	174
900.12	140	I70N2-01000	107	TMIM4-00000	166
900.16	66	I70N2-02000	106	TMIM4-04000	167
900.24	66	I70N2-03000	106	TMON8-00000	195
900.24/M	66	I70N2-04000	109	TMON8-01000	195
900.25	140	I70N2-05000	109	Z01RX-81000	275
900.32	144	I70N4-00000	155	Z84CX-00000	213
900.35	141	I70N4-01000	155	Z84CX-01000	213
900.35-140	120	I70N8-00000	193	Z84RX-00000	275
900.37	66-144	I70N8-01000	193	ZESNX-03000	273
900.39-240	141	I84M0-00000	205	ZESNX-04000	273
900.42	143	I84M0-01000	205		
900.42/1	143	I84M2-00000	206		
908.12	112	I84M2-01000	206		
908.32	161	I84M2-02000	207		
908.35	120	I84M2-03000	207		
908.35-140	230	I84M4-00000	208		
908.37	161	I84M4-01000	208		

Informativa sul trattamento dei dati personali (ex art.13 GDPR n. 679/2016)

Information on the processing of personal data (pursuant to Art. 13 of UE Regulation 2016/679 GDPR)

IDRAL SPA, con sede legale in via ISEI 8/10 28010 GARGALLO (NO), P.IVA 00124610031 in qualità di titolare del trattamento di dati personali, informa gli interessati che i dati personali saranno trattati nel rispetto dei principi di protezione stabiliti dal Regolamento UE n. 2016/679 (GDPR).

Finalità del Trattamento dei Dati raccolti

I Dati personali dell'interessato sono raccolti per consentire al Titolare di fornire i propri Servizi e/o adempiere obblighi contrattuali.

Pertanto il trattamento dei dati ha le seguenti finalità:

- permettere di fruire dei Servizi eventualmente richiesti;
- processare una richiesta di contatto;
- adempiere obblighi di legge connessi a rapporti commerciali
- adempiere obblighi fiscali o contabili
- marketing (analisi statistiche e indagini di mercato)
- verifiche del grado di soddisfazione della clientela sui prodotti

L'eventuale rifiuto nel consentire il trattamento dei dati comporta l'impossibilità di usufruire del servizio richiesto dall'interessato.

Solo previo specifico e distinto consenso, i dati personali sono utilizzati per le seguenti Altre Finalità:

- inviare via e-mail Newsletter riguardanti promozioni e aggiornamenti commerciali, presentazioni di nuovi prodotti e soluzioni tecniche, inviti ad eventi e fiere a cui partecipa il Titolare.

Modalità del trattamento

Il Titolare adotta le opportune misure di sicurezza volte ad impedire l'accesso, la divulgazione, la modifica o la distruzione non autorizzate dei Dati Personali. Il trattamento viene effettuato mediante strumenti informatici e/o telematici e/o cartacei, con modalità organizzative e con logiche strettamente correlate alle finalità.

Base Giuridica

Il conferimento dei dati è obbligatorio per tutto quanto è richiesto dagli obblighi legali e contrattuali e pertanto l'eventuale rifiuto a fornirli in tutto o in parte può dar luogo all'impossibilità di fornire i servizi richiesti.

La società tratta i dati facoltativi degli utenti in base al consenso, ossia mediante l'approvazione esplicita della presente policy privacy e in relazione alle modalità e finalità di seguito descritte.

Categorie di destinatari

Nella gestione dei dati, inoltre, possono venire a conoscenza degli stessi le seguenti categorie di persone autorizzate e/o responsabili esterni individuati per iscritto ed ai quali sono state fornite specifiche istruzioni scritte circa il trattamento dei dati:

- personale dipendente autorizzato
- responsabili del trattamento esterni designati, che svolgono attività di outsourcing per conto del Titolare (hosting provider, società informatiche, agenzie di comunicazione).

L'elenco aggiornato degli incaricati interni e dei Responsabili esterni potrà sempre essere richiesto al Titolare del Trattamento.

Comunicazione dei dati

Senza espresso consenso dell'interessato, il Titolare potrà comunicare i dati per le finalità di cui sopra a Organismi di vigilanza, Autorità giudiziarie nonché a tutti gli altri soggetti ai quali la comunicazione sia obbligatoria per legge per l'espletamento delle finalità dette. I Vostri dati non saranno oggetto di diffusione.

Periodo di conservazione

I Dati sono trattati e conservati per il tempo richiesto dalle finalità per le quali sono stati raccolti:

- I dati obbligatori ai fini contrattuali e contabili sono conservati per il tempo necessario allo svolgimento del rapporto commerciale e contabile;
- I dati di chi non acquista o usufruisce di prodotti/servizi, pur avendo avuto un precedente contatto con dei rappresentanti dell'azienda, saranno immediatamente cancellati o trattati in forma anonima, ove la loro conservazione non risulti altrimenti giustificata, salvo che sia stato acquisito validamente il consenso informato degli interessati relativo ad una successiva attività di promozione commerciale o ricerca di mercato. Il periodo di conservazione dei dati è: 10 anni dalla cessazione del rapporto.

Diritti dell'interessato

Ai sensi del Regolamento europeo 679/2016 (GDPR) e della normativa nazionale, l'interessato può, secondo le modalità e nei limiti previsti dalla vigente normativa, esercitare i seguenti diritti:

- richiedere la conferma dell'esistenza di dati personali che lo riguardano (diritto di accesso);
- conoscerne l'origine;
- riceverne comunicazione intelligibile;
- avere informazioni circa la logica, le modalità e le finalità del trattamento;
- richiederne l'aggiornamento, la rettifica, l'integrazione, la cancellazione, la trasformazione in forma anonima, il blocco dei dati trattati in violazione di legge, ivi compresi quelli non più necessari al perseguimento degli scopi per i quali sono stati raccolti;
- nei casi di trattamento basato su consenso, ricevere i propri dati forniti al titolare, in forma strutturata e leggibile da un elaboratore di dati e in un formato comunemente usato da un dispositivo elettronico;
- il diritto di presentare un reclamo all'Autorità di controllo.

Modalità di esercizio dei diritti

Potrete in qualsiasi momento esercitare i diritti inviando:

- una raccomandata a.r. alla IDRAL SPA, Via Isei 8/10, 28010 GARGALLO (NO) oppure una e-mail all'indirizzo privacy@idral.it

Titolare

Il Titolare del trattamento è IDRAL SPA con sede legale in Via Isei 8/10, 28010 GARGALLO (NO).

Modifiche alla presente Informativa

La presente Informativa può subire variazioni. Si consiglia, quindi, di controllare regolarmente questa Informativa e di riferirsi alla versione più aggiornata pubblicata su www.idral.it

IDRAL SPA, with registered office in via ISEI 8/10, 28010 GARGALLO (NO), Italy; VAT number 00124610031, with its role as personal data Controller, informs the data subjects that personal data shall be processed according to the data protection principles established in the UE Regulation 2016/679 (GDPR).

The purposes of the processing of collected data

Personal data of the data subject are collected to enable the Controller to provide Services and/or fulfil contractual obligations. Therefore, the purposes of data processing are the following:

- allow the use of potentially required Services;
- process a contact request;
- fulfil legal obligations related to commercial relationships;
- fulfil tax and accounting obligations;
- marketing (statistical analyses and market researches);
- assessment of the customer satisfaction regarding the products.

Should the data subject not allow the data processing, he or she will not be able to use the required service.

Only upon specific and clear consent, personal data are used for the following additional purposes:

- send Newsletter via email regarding commercial promotions and updates, presentations of new products and technical solutions, invites to events and trade fairs in which the Controller participates.

Methods of processing

The Controller shall take any suitable measure aimed at preventing non-authorized access, disclosure, alteration or destruction of personal data. Processing is carried out through computer and/or online and/or paper tools, and the organizational methods are strictly related to the purposes.

Legal basis

Data collection is mandatory according to that required by legal and contractual obligations and, therefore, refusing to provide such data, totally or partially, may impede the supply of the requested services. The company processes optional user data according to the consent, namely with the explicit approval of this privacy policy and depending on the methods and purposes described below.

Categories of addresses

Furthermore, the following categories of authorised people and/or external processors that are identified in writing and who have been given specific written instructions about data processing, may become aware of the data while such data are processed:

- authorised employees
- external designated processors who carry out outsourcing activities on behalf of the Controller (hosting providers, IT companies, communication agencies).

The updated list of the authorised employees and the external processors can be required at any time from the Controller.

Data transmission

The Controller is entitled to transmit data for the purposes described above without explicit consent of the data subject to oversight bodies, judicial authorities, as well as to any other subject whenever such transmission is legally required in order to achieve the abovementioned purposes. Your data will not be disseminated.

Storage duration

Data are processed and stored for the period necessary for the purposes the data initially were collected:

- Mandatory data for contractual and accounting purposes are stored for the time necessary to handle the commercial and accounting relationship;
- Data of those who do not buy or use products/services, despite having had a previous contact with any representative of the company, will immediately be erased or processed anonymously, unless the storage is otherwise justified, and provided the data subjects have duly given their informed consent regarding a subsequent commercial promotion or market research activity. The storage duration of data is: 10 years after termination of the relationship.

Rights of the data subject

Pursuant to the European Regulation 2016/679 (GDPR) and to the national legislation, the data subject can exercise the following rights within the limits and in accordance with the regulation in force:

- ask for the confirmation of the existence of personal data relating to him or her (access rights);
- be aware of their source;
- receive comprehensible communication of it;
- receive information regarding the logics, the methods and the purposes of the processing;
- request the update, rectification, integration, erasure, anonymous transformation, blocking of data processed illegally, including data that are no longer necessary to achieve the purposes they had been collected for;
- in the case of processing based on consent, the right to receive personal data concerning him or her which he or she has provided to the Controller in a structured, commonly used and machine-readable format;
- the right to lodge a complaint with a supervisory authority.

Procedure for the exercise of rights

You can exercise your rights at any time sending:

- a registered letter to IDRAL SPA, Via Isei 8/10, 28010 GARGALLO (NO), Italia or an e-mail to privacy@idral.it

Controller

The Controller is IDRAL SPA, with registered office in via ISEI 8/10, 28010 GARGALLO (NO), Italy.

Amendments of this Information document

This information document may be subject to amendments. It is therefore recommended to check this document on a regular basis and to refer to its latest version on www.idral.it.



1.1 Definizioni:

- "Atto" indica la legge italiana e la disciplina dell'Unione Europea sulle normative tecniche e sulla sicurezza dei prodotti;
- "Venditore" indica Idral S.P.A., con sede in Via Isei 8/10 28010 Gargallo (NO), Italia, società che produce e commercializza i prodotti appartenenti al settore sanitario così come indicati sul proprio sito www.idral.it (qui di seguito i "Prodotti") nonché i manufatti su richiesta e su modelli indicati dal cliente;
- "Acquirente" indica qualsiasi società che ha effettuato l'Ordine;
- "Condizioni" indica i presenti termini e le presenti condizioni contrattuali;
- "Informazioni riservate" indica qualsiasi informazione che una delle parti identifica come riservata ad esclusione delle informazioni disponibili di pubblico dominio a meno che tali informazioni non diventino di pubblico dominio a seguito di una violazione della riservatezza da parte dell'altra parte disciplinata nelle presenti Condizioni;
- "Diritti di proprietà industriale" indica tutti i diritti di proprietà industriale compresi i diritti attuali e futuri registrati e non registrati in relazione al copyright, marchi, segreti commerciali, know-how, informazioni riservate;
- "Ordine" indica il documento inviato dall'Acquirente indicante le specifiche tecniche del prodotto ordinato al Venditore, la quantità, il prezzo proposto dall'Acquirente al Venditore per la fornitura di Prodotti;
- "Conferma d'Ordine" indica il documento inviato dal Venditore in risposta all'Ordine dell'Acquirente in riferimento alle presenti Condizioni, alle specifiche tecniche del Prodotto richiesto dall'Acquirente, alla quantità di Prodotti richiesta nonché al prezzo per la fornitura di Prodotti;
- "Specifiche Tecniche" indica tutte le specifiche tecniche relative al tipo e alla qualità dei Prodotti riportate nell'Ordine se accettate dal Venditore nella sua Conferma d'Ordine;
- "Consegna" indica qualsiasi spedizione effettuata dal Venditore, nel corso dell'anno, in esecuzione della Conferma d'Ordine in conformità al termine di resa EXW Via Isei 8/10 28010 Gargallo (NO), Italia, come definito dagli Incoterms® ICC 2020, salvo diversamente pattuito nella Conferma d'Ordine;
- "Certificazione di Qualità" indica l'analisi effettuata da un laboratorio italiano di altamente qualificato al fine di attestare che il Prodotto è conforme alle Specifiche Tecniche concordate nella Conferma d'Ordine in caso di reclamo da parte dell'Acquirente;
- "Ispezione" indica qualsiasi tipo di ispezione effettuata dall'Acquirente al fine di verificare la conformità del Prodotto alle Specifiche Tecniche concordate nella Conferma d'Ordine.

2. Fornitura di Prodotti e Condizioni

- 2.1 Il Venditore si impegna a fornire e l'Acquirente si impegna ad acquistare i Prodotti secondo i termini stabiliti nelle presenti Condizioni.
- 2.2 Le presenti Condizioni regolano qualsiasi Ordine effettuato dall'Acquirente come accettato ed integrato dalla Conferma d'Ordine effettuata per iscritto dal Venditore.

3. Ordini

- 3.1 L'Acquirente trasmette al Venditore un Ordine per una determinata quantità di Prodotti, indicando il prezzo e le Specifiche Tecniche richieste. Tutti gli Ordini devono essere accettati dal Venditore con la Conferma d'Ordine per iscritto.
- 3.2 Un preventivo del Venditore non costituisce offerta vendita del Prodotto a cui si fa riferimento nel preventivo. A meno che il Venditore non abbia accettato di fissare i prezzi per periodi di tempo specificati, tutte le quotazioni scadono 3 giorni lavorativi dopo l'emissione e possono essere ritirate o modificate dal Venditore in qualsiasi momento.
- 3.3 Le presenti Condizioni prevarranno in caso di difformità con qualsiasi Ordine.

4. Prezzo e pagamento

- 4.1 Il prezzo del Prodotto sarà quello indicato dal Venditore nella Conferma d'Ordine.
- 4.2 Salvo diverso accordo scritto del Venditore, il Venditore non è autorizzato a modificare il prezzo dei Prodotti concordato nella Conferma d'Ordine a meno che non dimostri un aumento del prezzo della materia prima superiore al 5% (cinque per cento).
- 4.3 Ferme restando le presenti Condizioni, i Prodotti forniti dal Venditore dovranno essere pagati secondo il termine indicato nella Conferma d'Ordine.
- 4.4 Salvo patto contrario, tutti i pagamenti devono essere effettuati tramite bonifico bancario in Euro.
- 4.5 Il Venditore può annullare gli Ordini successivi nel caso in cui l'Acquirente non rispetti i termini di pagamento per più di 20 (venti) giorni.

5. Consegna e rischi

- 5.1 I Prodotti saranno consegnati dal Venditore nel luogo e nelle date indicate nella Conferma d'Ordine.
- 5.2 Il Venditore non è obbligato a consegnare i Prodotti a meno che non sia stato effettuato il pagamento per la precedente consegna di Prodotti.
- 5.3 Il Venditore non sarà responsabile per eventuali perdite, danni o spese sostenute dall'Acquirente, o da qualsiasi altro soggetto, a causa di un ritardo nella consegna o nel ritiro dei Prodotti.

6. Passaggio della proprietà

- 6.1 Il Venditore manterrà la proprietà dei Prodotti fornito all'Acquirente fino al completo pagamento al Venditore del prezzo di acquisto dei Prodotti.
- 6.2 Fino a quando il titolo non viene trasferito all'Acquirente: (a) l'Acquirente possiederà i Prodotti unicamente come mandatario del Venditore; (b) l'Acquirente assicurerà i Prodotti contro tutti i rischi abituali fino all'intero valore di sostituzione e manterrà in custodia per il Venditore qualsiasi somma pagata dall'assicurazione ricevuta dall'Acquirente per i Prodotti; (c) l'Acquirente conserverà i Prodotti separatamente, chiaramente identificato come proprietà del

Venditore e in modo da consentirne l'identificazione e il riferimento incrociato a specifiche fatture ove ragionevolmente possibile; e (d) l'Acquirente non si impegnerà o consentirà che alcun vincolo, onere o altro gravame sorga sui Prodotti.

7. Garanzia

- 7.1 Il Venditore garantisce all'Acquirente che: (a) i Prodotti sono conformi alle normative indicate nell'Atto; (b) i Prodotti sono conformi alle Specifiche Tecniche indicate nella Conferma d'Ordine.
- 7.2 L'Acquirente garantisce che: (a) ha ricevuto informazioni adeguate in merito ai Prodotti per garantirne la sicurezza nell'uso e nello stoccaggio; e (b) assicurerà che i Prodotti siano stoccati e utilizzati correttamente.
- 7.3 L'Acquirente dovrà effettuare un'ispezione dei Prodotti alla consegna indicando sulla lettera di vettura e comunque su una specifica denuncia scritta da inviarsi via email al Venditore ogni difetto immediatamente riscontrabile derivante dallo stato dei Prodotti all'arrivo. In ogni caso l'Acquirente - non appena scoperto il difetto - dovrà darne specifica notizia scritta alla Venditrice entro 10 (dieci) giorni dalla scoperta.
- 7.4 Nel reclamo l'Acquirente dovrà includere il numero e la data della Conferma d'Ordine nonché le immagini e le descrizioni dei vizi. Le parti convengono che in caso di disaccordo sul difetto denunciato entrambe potranno sottoporre ad un ente terzo specializzato altamente qualificato la questione relativa alla non conformità dei Prodotti alle Specifiche Tecniche indicate nella Conferma d'Ordine. La valutazione tecnica del Laboratorio sarà vincolante per entrambe le parti.
- 7.5 L'Acquirente deve ottemperare a qualsiasi richiesta del Venditore in relazione alla restituzione dei Prodotti che si presume essere difettosa.
- 7.6 Se i Prodotti non sono conformi alla clausola 7.1(b), la responsabilità del Venditore nei confronti dell'Acquirente è limitata alla sostituzione del Prodotto difettoso a condizione che sia stato immagazzinato e utilizzato secondo le istruzioni del Venditore.
- 7.7 Nonostante qualsiasi altra disposizione delle presenti Condizioni, la massima responsabilità del Venditore nei confronti dell'Acquirente per violazione del contratto, negligenza o altro in relazione alle presenti Condizioni o ai Prodotti è limitata all'importo pagato o pagabile dall'Acquirente per i Prodotti da fornirsi in sostituzione dei Prodotti difettosi.
- 7.8 Nessuna delle parti sarà responsabile nei confronti dell'altra parte o di qualsiasi altro soggetto per danni diretti e/o indiretti e per danni derivanti da ogni perdita di utili, perdita di occasioni di affari o danno all'immagine.
- 7.9 Per quanto concerne l'imballaggio, in caso di packaging per private label con marchio dell'Acquirente, la quantità minima di imballaggi dovrà essere concordata per iscritto con l'Acquirente. In assenza il Venditore potrà stabilire una quantità massima di imballaggi. Il Venditore non è responsabile delle diciture scritte sugli imballaggi su istruzioni dell'Acquirente.
- 7.10 In caso di sospensione/interruzione della fornitura, i costi degli imballaggi sono a carico dell'Acquirente.

8. Informazioni riservate and Diritti di Proprietà Industriale

- 8.1 Nessuna delle parti può, senza il previo consenso scritto dell'altra parte: (a) divulgare Informazioni riservate a qualsiasi altro soggetto; o (b) utilizzare le Informazioni riservate per qualsiasi motivo diverso dal proseguimento del rapporto d'affari tra l'Acquirente e il Venditore, (c) salvo, ove richiesto dalla legge o dal regolamento di una borsa merci o dall'informazione dovuta alle autorità pubbliche finanziarie o altri consulenti aventi titolo.
- 8.2 Né il Venditore né l'Acquirente trasferiscono tramite le vendite alcun diritto, titolo o interesse relativo a diritti di proprietà industriale all'altra parte. A ciascuna parte è vietato utilizzare i diritti di proprietà industriale dell'altra parte (inclusi ma non limitati ai marchi) a meno che non sia autorizzato per iscritto dalla parte proprietaria.

9. Forza Maggiore

- 9.1 Il Venditore non sarà responsabile se il Venditore viene ritardato o impedito di consegnare i Prodotti, o di adempiere in altro modo a uno qualsiasi dei suoi obblighi contrattuali, a causa di qualsiasi causa o circostanza al di fuori del suo ragionevole controllo, inclusi eventi epidemici e/o pandemie, eventi naturali, tempeste, disastri naturali, atti di guerra o terrorismo, sabotaggio, atti di autorità governative o regolamentari, scioperi o altre controversie industriali, ordinanze del tribunale, guasto delle attrezzature o mancata consegna da parte dei fornitori del Venditore. Per effetto dell'evento, l'interessato avrà diritto alla sospensione o alla proroga dei termini entro i quali deve adempiere alle obbligazioni contrattuali, fermo restando che se la causa di forza maggiore si protrae per più di sessanta (60) giorni, il Venditore avrà il diritto di annullare qualsiasi ordine già in corso.

10. Miscellanea

- 10.1 Le presenti Condizioni, nonché l'Ordine e la Conferma d'Ordine effettuati dalle Parti, sono regolati dalla legge italiana.
- 10.2 Qualsiasi controversia derivante o connessa alle presenti Condizioni nonché all'Ordine e alla Conferma d'Ordine formulata dalle Parti sarà risolta mediante arbitrato ai sensi del Regolamento della Camera Arbitrale di Milano (il Regolamento), da un arbitro unico, nominato secondo il Regolamento. La sede dell'arbitrato sarà Milano, Italia. Nel caso in cui l'Acquirente abbia sede in Italia il Venditore si riserva il diritto di adire il Foro di Torino per qualunque controversia derivante o connessa alle presenti Condizioni.
- 10.3 Salvo quanto diversamente concordato per iscritto dalle parti, qualsiasi Accordo tra le parti, le presenti Condizioni, unitamente a qualsiasi Ordine accettato dal Venditore nella Conferma d'Ordine, costituiscono tutte le condizioni che regolano la vendita dei Prodotti dal Venditore all'Acquirente.
- 10.4 Nessuna delle parti può cedere tutti o alcuno dei propri diritti o obblighi ai sensi delle presenti Condizioni senza il previo consenso scritto dell'altra parte.



1.1 Definitions:

- “Act” means the Italian and U.E. Regulations concerning the technical standards and safety rules of the products;
- “Seller” means Idral S.r.l., having its seat in Via Isei 8/10, 28010 Gargallo (NO), Italy company who made and sell the products belonging to healthcare field as well as the product made on request and following the models indicated by the customers (hereinafter the “Products”);
- “Buyer” means any company which made the Order;
- “Conditions” means these terms and conditions;
- “Confidential Information” means any information which either party identifies as confidential but does not include information which is available in the public domain unless that information enters the public domain as a result of a breach of confidence by the other party being regulated in the present Conditions;
- “Intellectual Property Rights” means all intellectual property rights including current and future registered and unregistered rights in respect of copyright, trademarks, trade secrets, know-how, confidential information;
- “Order” means the document sent by the Buyer indicating the technical specifications of the Product requested to the Seller, the quantity, the price proposed from the Buyer to the Seller for the supply of the Products;
- “Order Confirmation” means the document sent by the Seller answering to the Buyer’s Order referring to the present Conditions, the technical specifications of the Products requested by the Buyer, the quantity of Products requested in the Order as well as the Price for the supply of the Products;
- “Technical Specifications” mean all the technical specifications relating to the type and quality of Products set out in its Order if accepted by the Seller in its Order Confirmation.
- “Delivery” means any shipment made by the Seller, during the year, in execution of the Order Confirmation following EXW Via Isei 8/10, 28010 Gargallo (NO), Italy, as defined by the Incoterms® ICC 2020 unless differently agreed in the order Confirmation;
- “Quality Certification” means the analysis made by an Italian high ranked laboratory in order to state that the Products is complying with the Technical Specifications agreed in the Order Confirmation in case of claim made by the Buyer;
- “Inspection” means any kind of inspection made by the Buyer in order to verify the compliance of the Products with the Technical Specifications agreed in the Order Confirmation.

2. Supply of Products and Conditions

- 2.1 The Seller agrees to supply and the Buyer agrees to purchase the Products on the terms and conditions set out in these Conditions.
- 2.2 These Conditions are regulating any Order made by the Buyer as accepted and integrated by the Order Confirmation made by the Seller in writing.

3. Orders

- 3.1 The Buyer shall submit an Order to the Seller for a definite quantity of Products indicating the price and the Technical Specifications required. All Orders must be accepted by the Seller with the Order Confirmation in writing.
- 3.2 A Seller quotation is not an offer to supply the Products referred to in the quotation. Unless the Seller has agreed to set price for specified periods of time, all quotations lapse 3 business days after issue and may be withdrawn or changed by the Seller at any time.
- 3.3 These Conditions will prevail to the extent of any legal inconsistency with any Order.

4. Price and payment

- 4.1 The price of Products will be as agreed in writing by the Seller in the Order Confirmation.
- 4.2 Unless otherwise agreed in writing by the Seller, the Seller is not allowed to change the price of Products agreed in the Order Confirmation unless it gives evidence of the increase of the raw material price for more than 5% (five per cent).
- 4.3 Subject to these Conditions, the Products supplied by the Seller must be paid following the term indicated in the Order Confirmation.
- 4.4 Unless otherwise agreed, all payments are to be made by bank transfer in Euros.
- 4.5 The Seller may cancel the Order in case the Buyer does not respect the terms of payment for more than 20 (twenty) days.

5. Delivery and risk

- 5.1 The Products will be delivered by the Seller to the place and on the dates set out in the Order Confirmation.
- 5.2 The Seller is not obliged to deliver Products unless the payment for the previous delivery of Products has been made.
- 5.3 The Seller shall not be liable for any losses, damages or expenses sustained by the Buyer, or any other party, due to a delay in delivery or collection of the Products.

6. Title

- 6.1 The Seller will retain the title of the Products supplied to the Buyer until the purchase price of the Products has been paid in full to the Seller.
- 6.2 Until the title passes to the Buyer: (a) the Buyer will hold the Products as agent for the Seller only; (b) the Buyer will insure the Products against all usual risks to full replacement value and hold any insurance monies received by the Buyer for Products on trust for the Seller; (c) the Buyer will store the Products separately, clearly identified as the Seller’s property and in a manner to enable them to be identified and cross-referenced to particular invoices where reasonably possible; and (d) the Buyer will not pledge or allow any lien, charge or other encumbrance to arise over the Products.

7. Warranties

- 7.1 The Seller warrants to the Buyer that: (a) the Products are complying with all Acts; (b) the Products comply with the Technical Specifications indicated in the Order Confirmation; and (c) it has all necessary licenses, consents and authorizations required to produce, package and supply the Products under these Conditions.
- 7.2 The Buyer warrants that: (a) it has received adequate information regarding the Products to ensure their safe use, handling and storage; and (b) it will ensure that the Products are properly used and stored.
- 7.3 The Buyer must make an Inspection of the Products on delivery and/or at Seller premises, indicating on the bill of lading and/or through a specific written claim to be sent by email to the Seller any defect of the product immediately found at the arrival. In any case the Buyer shall communicate the claim within 10 (ten) days from the defect discovery.
- 7.4 In its claim, the Buyer must include the Order Confirmation number and date as well as the pictures and descriptions of the defects. The parties concur that in case of a disagreement regarding the claim, both of them may submit the case to a specialized third party, to clarify the potential differences between the Products to the Technical Specifications indicated in the Order Confirmation. The technical evaluation of the Laboratory shall be binding for both parties.
- 7.5 The Buyer must comply with any request from the Seller in relation to the return of Products that are alleged to be defective.
- 7.6 If the Products do not comply with clause 7.1(b), the Seller’s liability to the Buyer is limited to replace the defective Products provided that it has been stored and packaged by the Seller directly or by the Buyer following the instruction of the Seller.
- 7.7 Despite any other provision of these Conditions, the maximum liability of the Seller to the Buyer for breach of contract, negligence or otherwise in connection with these Conditions of the Products is limited to the amount paid or payable by the Buyer for the Products to be supplied under these Conditions.
- 7.8 Neither party will be liable to the other party or any other person for indirect or consequential losses or damages and for any loss of profits, loss of business opportunity, costs and damage to reputation.
- 7.9 As far as the packaging for the private label sale is concerned, the minimum quantity of packaging and materials must be agreed in writing between the Seller and the Buyer. If not, the Seller shall fix a maximum quantity of packaging materials to be used. The Seller is not liable for the labels on the packaging which shall be made following the Buyers guidelines.
- 7.10 In case the Buyer hold on or cancel the Order, the packaging costs shall be at its own charge.

8. Confidential Information and Intellectual Property Rights

- 8.1 Neither party may, without the prior written consent of the other party: (a) disclose Confidential Information to any other person; or (b) use Confidential Information for any reason other than the furtherance of the business relationship between the Buyer and the Seller, (c) except where required by law or the rules of a stock exchange or disclosure to that party’s legal, financial or other advisers.
- 8.2 Neither the Seller nor the Buyer transfers any right, title or interest in any Intellectual Property Rights of the respective party to the other. Each party is prohibited from using the other party’s Intellectual Property Rights (including but not limited to trademarks) unless authorized in writing by the owning party.

9. Force Majeure

- 9.1 The Seller will not be liable if the Seller is delayed or prevented from delivering Products, or otherwise performing any of its contractual obligations, due to any cause or circumstance beyond its reasonable control including epidemic and/or pandemic events, acts of God, floods, storms, natural disasters, acts of war or terrorism, sabotage, acts of government or regulatory authority, strikes or other industrial disputes, court orders, breakdown of equipment or the failure by the Seller’s suppliers to deliver to the Seller. As a result of the event, the affected Party shall have the right to a suspension or an extension of the times within which he must fulfill his contract obligations, it remaining nevertheless understood, that if the unforeseen event extends for more than sixty (60) days, the Seller shall be entitled to cancel any order that is already in progress.

10. General

- 10.1 These Conditions as well as the Order and the Order Confirmation made by the Parties are governed by the Italian laws.
- 10.2 Any dispute arising out or related to these Conditions as well as the Order and the Order Confirmation made by the Parties shall be settled by arbitration under the Rules of the Chamber of Arbitration of Milan (the Rules), by a sole arbitrator, appointed in accordance with the Rules. Place of arbitration shall be Milan, Italy. Language Arbitration shall be English. In case the Buyer has its own seat in Italy, the Seller has the choice to made the claim to the Italian Court of Torino for any dispute arising of the present Conditions as well as the Order and the Order Confirmation made by the Parties.
- 10.3 Except as otherwise agreed in writing by the parties, any Agreement between the parties, these Conditions, together with any Order accepted by the Seller in the Order Confirmation, constitute all of the terms of the contract for the sale of the Products by the Seller to the Buyer.
- 10.4 Neither party may assign all or any of its rights or obligations under these Conditions without the prior written consent of the other party.



**Web, tutorial installazione
e manutenzione, f.a.q.**

**Web, installation
and maintenance tutorial, f.a.q.**

www.idral.it
www.idral.it/tutorial/
www.idral.it/f-a-q/



Social

www.linkedin.com/company/idral-spaw
www.facebook.com/Idralsparubinetteria/
www.youtube.com

800 912 524

**Assistenza clienti
e assistenza tecnica**

**Customer service
and technical assistance**



**Assistenza progettisti
e ufficio tecnico**

**Design assistance
and technical office**

tecnico@idral.it
+39 0322 912017

Tutte le immagini presenti su questo catalogo sono di proprietà di Idral SpA e sono inserite a solo scopo illustrativo. È vietata la copia e la riproduzione dei contenuti e delle immagini in qualsiasi forma.

Ci riserviamo il diritto di modificare le specifiche dei prodotti senza alcun preavviso al fine di migliorare gli stessi.

All images in this catalogue are the property of Idral SpA and are included for illustrative purposes only.

Copying and reproduction of the contents and images in any form is prohibited.

We reserve the right to change product specifications without prior notice in order to improve the products.



**Idral SPA via Isei 8/10
28010 Gargallo (NO) Italy
tel +39 0322 912017
info@idral.it | www.idral.it**

idral 
ITALIAN PARTNER FOR WATER SOLUTIONS

www.idral.it