



NOVELLINI



ÍNDICE



MAMPARAS PARA DUCHA / RESGUARDOS DE BANHEIRAS

021	OPERA	149	N180
035	KUADRA 2.0	159	YOUNG PLUS
053	ROSE	171	YOUNG
069	ZEPHYROS 2.0	211	GALA
095	LUNES	223	BRERA
125	STAR 2.0	233	FREE
143	RIVIERA		



ESPACIOS ABIERTOS / ESPAÇOS ABERTOS

249	H STYLE
253	H ART
275	KUADRA H FRAME COLLECTION
290	KUADRA H IN ART
297	GIADA H EDGE COLLECTION



MAMPARAS PARA BAÑERA / RESGUARDOS PARA BANHEIRA

312	KUADRA
313	YOUNG
316	AURORA



PLATOS DE DUCHA / BASES DE CHUVEIRO

329	NOVOSOLID
335	CUSTOM TOUCH
339	CUSTOM
343	OLYMPIC PLUS
345	OLYMPIC
347	VICTORY



DUCHAS Y COLUMNAS / BASES DE CHUVEIRO

350	F
351	Z
353	EASY
355	LINE
357	REVIF
358	VANITY



CABINAS DE HIDROMASAJE / CABINAS HIDROMASSAGEM

363	SKILL
371	GLAX 2
383	GLAX 1
395	EON
409	MEDIA GLASS
417	MEDIA
435	REVOLUTION



BAÑERAS / BANHEIRAS

465	INFINITIVE	527	IRIS
469	SHIP	531	CALYPSO
475	DIVINA	533	VOGUE
501	STILE	534	BABY
511	SENSE 2.0		
523	CALOS		



ACCESORIOS / ACESSÓRIOS

565	ACCESORIOS FRAME / EDGE
579	ACCESORIOS
586	TIRADORES
591	PERFILES / PERFIS
607	GRIFERIA



MINIPISCINAS OUTDOOR SPA

616	MOON
619	DIVINA SPA
635	VITA
643	COMPLEMENTOS

TARIFA DE PRECIOS (IVA no incluído en el precio)
TABELA DE PREÇOS (IVA não incluído no preço)

 **100% MADE IN ITALY**



ITALIAN PLANT NOVELLINI

Los valores familiares son la base y el timón de la Actividad emprendedora de la familia Novellini, generación tras generación. La pasión y el compromiso, la innovación y la creatividad, además de una responsable atención a las exigencias de los clientes, son los valores que busca Novellini.

El Grupo Novellini es el líder en Europa en la producción de mamparas de baño, cabinas y bañeras de hidromasaje, con fábricas en Italia y Francia, con filiales en los principales países europeos y representaciones en otros continentes.



1°

EL MAYOR PRODUCTOR EUROPEO



160.100.000

FACTURACIÓN TOTAL DEL GRUPO



50

PAÍSES ATENDIDOS EN EL MUNDO



737

EMPLEADOS



9.000

CLIENTES



15

TRAILERS DE EXPEDICIONES DIARIAS



10.000 M²

ALMACÉN INTELIGENTE



80.000

PRODUCTOS EN STOCK

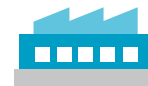

250.000 M²

DE PRODUCCIÓN INTEGRAL



1.000.000

DE ARTÍCULOS DE PRODUCCIÓN ANUAL



VERDE

ÉS ALGO MÁS QUE UN COLOR: ÉS RESPONSABILIDAD

Nuestro código ético en materia medioambiental: todos nuestros productos están realizados para satisfacer las más recientes normativas europeas en términos de calidad y seguridad ambientales.

La implantación de procesos productivos de bajo impacto ambiental, el control de las emisiones de sustancias tóxicas y el ahorro energético, son las respuestas a la problemática de un mundo en constante evolución.

Este conjunto de actividades ha permitido a Novellini ser citada en 2017 y 2019 en el informe GREEN ITALY, como la única empresa de nuestro sector que ha implementado en sus protocolos productivos procesos ecosostenibles y respetuosos con el medio ambiente.



NOVELLINI HA OBTENIDO RECIENTEMENTE LA CERTIFICACIÓN EPD PARA 9 GAMAS DE MAMPARAS Y ESPACIOS DE DUCHA.

EPD (Environmental Product Declaration) es una Declaración Ambiental de Producto que define el impacto ambiental del producto, de acuerdo con las normas internacionales ISO 14025 y EN 15804.

La EPD informa de los resultados calculados mediante el análisis del ciclo de vida del producto utilizando el método LCA (Life Cycle Assessment), evaluando el consumo de recursos (materiales, agua, energía) y el impacto en el medio ambiente circundante en las distintas fases del ciclo de vida, desde la extracción de las materias primas hasta su transporte, producción y eliminación del producto al final de su vida útil.

Lunes, Kuadra 2.0, Young, Opera, Kuadra H y Giada H están certificados con EPD para un enfoque consciente de la sostenibilidad. El certificado EPDItaly0346 puede consultarse en www.epditaly.it

Novellini también participó en una actividad sectorial, certificando las gamas Louvre, Zephyros y Kuadra H con EPD, como parte de una EPD sectorial media. El certificado EDP nº S-P-01811 puede consultarse en www.environdec.com



NOVELLINI



DESCUBRE
Y CONSULTA NUESTRA
NUEVA WEB B2B:
novellini.alugas.es

**CONSULTA STOCK, ESTADO DE PEDIDOS, SITUACIÓN DE ENVÍOS,
TRACKING DE ENTREGA, DESCARGA IMÁGENES DE PRODUCTOS,
ACCEDE AL SERVICIO POSTVENTA, GESTIONA RECAMBIOS Y MUCHO MÁS...**

Accede desde cualquier dispositivo.





PROMOSTOCK

DESCUBRE PROMOSTOCK 2023

La nueva tarifa Novellini en la que podrás encontrar todos los productos de máxima rotación con una garantía de entrega inmediata.







CONSULTA A TU DELEGADO

MAMPARAS DE BAÑO

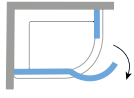
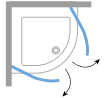
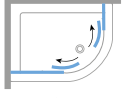
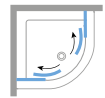
RESGUARDOS DE BANHO

ÍNDICE POR MODELO

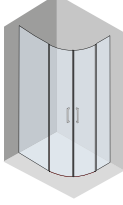
VETRO

		SEMICIRCULAR ABATIBLES SEMICIRCULAR ABATIVEIS			SEMICIRCOLARI - SCORREVOLI	
8mm	OPERA					
6/8mm	KUADRA 2.0					
6mm	ROSE				p. 65	p. 65
6mm	ZEPHYROS 2.0					p. 85
4/5/6mm	LUNES					p. 113
3/4/5mm	STAR 2.0					p. 129
3/4mm	RIVIERA					p. 146
8mm	N180					
8mm	YOUNG PLUS					
6mm	YOUNG	p. 198	p. 196,197	p. 199		
8mm	GALA					
6mm	BRERA	p. 229				
3/6mm	FREE					

VETRO

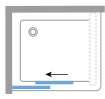
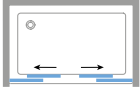
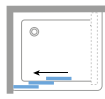
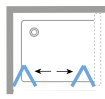
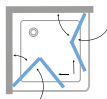
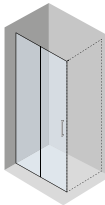
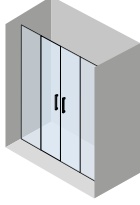
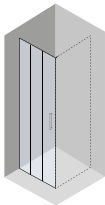
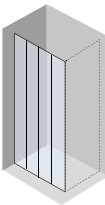
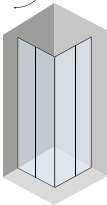

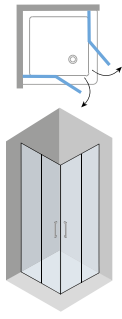
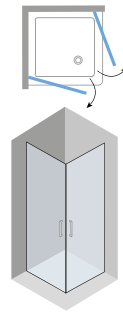
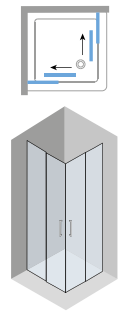
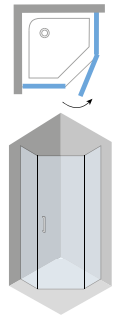
		PUERTAS CORREDERAS PORTAS DE CORRER			PUERTAS PLEGABLES PORTAS DESDOBRAVELS	
						
						
8mm	OPERA	p. 22,24,26	p. 28			
6/8mm	KUADRA 2.0	p. 36,38	p. 40			
6mm	ROSE	p. 54,56,58,59		p. 60,64		
6mm	ZEPHYROS 2.0	p. 70,72,	p. 74	p. 83	p. 81,82	
4/5/6mm	LUNES	p. 100,102	p. 112	p. 108,110	p. 107	
3/4/5mm	STAR 2.0	p. 128		p. 130	p. 133	
3/4mm	RIVIERA	p. 144		p. 146	p. 145	
8mm	N180					
8mm	YOUNG PLUS					
6mm	YOUNG				p. 188,190	p. 192,200,202
8mm	GALA					
6mm	BRERA					
3/6mm	FREE					p. 240,241,242

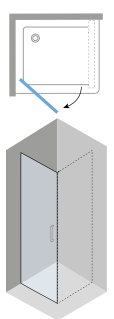
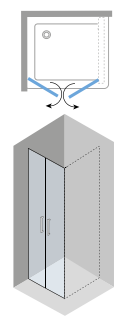
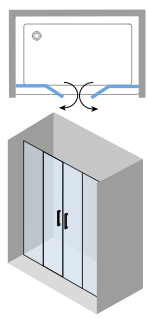
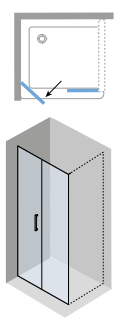
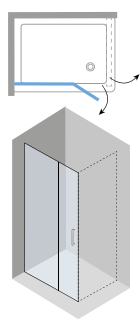
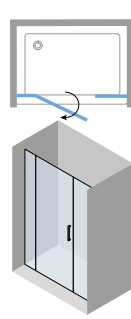
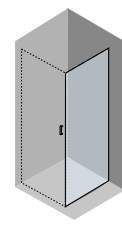
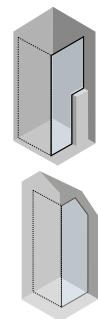
ANGULAR ABATIBLES ANGULAR ABATIVEIS		ANGULAR CORREDERAS ANGULAR DE CORRER		PENTAGONO - BATTENTI	
					
		p. 30			
		p. 44			
		p. 62			
		p. 76,78			
		p. 96,98		p. 114	
		p. 126			
		p. 144			
	p. 166				
p. 194	p. 196				
		p. 228			
p. 239	p. 234				

PUERTAS ABATIBLES PORTAS ABATIVEIS						FIJOS FIXOS	FIJOS ESPECIALES FIXOS ESPECIAIS
							
p. 46	p. 50		p. 42			p. 36,48	
						p. 66	
p. 84	p. 80					p. 86	p. 81-91
p. 104	p. 106		p. 112			p. 115,116,117	p. 118-122
p. 131	p. 132					p. 134,135	p. 136-140
p. 145						p. 147	
p. 152,154			p. 150				
p. 162,164			p. 160				
p. 182,184	p. 180	p. 178		p. 176	p. 172	p. 172,176,184	p. 204-206
				p. 212,214,216,218		p. 216	
				p. 224,226		p. 226	
p. 236,237	p. 238			p. 235		p. 236	

CABINAS

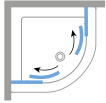
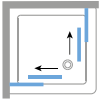
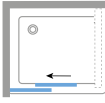
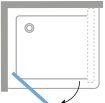
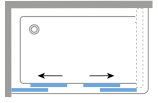
ÍNDICE POR MODELO

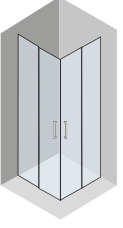
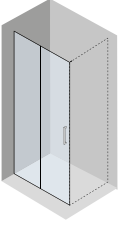
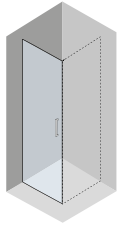
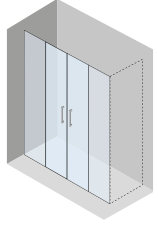
		SEMICIRCULAR	ANGULAR	PUERTA - PORTA		
CRISTAL						
						
8mm	SKILL		p. 366	p. 368		p. 364
5/6mm	GLAX 1	p. 390	p. 386,392	p. 384,393	p. 388	
5/6mm	GLAX 2	p. 378	p. 374,380	p. 372,381	p. 376	
6mm	EON	p. 408	p. 400	p. 396,398	p. 402,404	
3/4mm	MEDIA GLASS		p. 414,415	p. 410	p. 412	
3mm	MEDIA	p. 422	p. 420	p. 418	p. 419	

BAÑERAS / BANHEIRAS

ÍNDICE POR MODELO

	BAÑERA ANGULAR BANHEIRA ANGULAR	BAÑERA RECTANGULAR BANHEIRA RECTANGULAR	BAÑERA EXENTA BANHEIRA EXENTA	BAÑERA PARA EMPOTRAR BANHEIRA PARA EMBUTIR
				
INFINITIVE	p. 466		p. 466	
SHIP	p. 470		p. 470	
DIVINA DUAL		p. 476	p. 476	p. 476
DIVINA	p. 476,484,488,502	p. 492,496	p. 480,481	p. ,481,496
STILE	p. 502		p. 510	p. 502,510
SENSE DUAL		p. 512	p. 512	p. 512
SENSE 3 - 4 2.0		p. 516,518	p. 516,518	p. 516,518
CALOS		p. 524		p. 524
IRIS		p. 528		
CALYPSO		p. 530		
VOGUE	p. 532			p. 532
BABY				p. 534



N180 - MAMPARAS PARA DUCHA / RESGUARDOS DE BANHEIRAS

Color perfil / Cor perfil: Oro rosa satinado
Cristal templado / Vidro temperado: transparente



HD FRAME - *ESPACIOS ABIERTOS / ESPAÇOS ABERTOS*

Color perfil / *Cor perfil*: Bronce Satinado
Cristal templado / *Vidro temperado*: Transparente



HP ART - ESPACIOS ABIERTOS / ESPAÇOS ABERTOS

Color perfil / Cor perfil: Oro satinado
Cristal templado / Vidro temperado: Flute



HP ART - ESPACIOS ABIERTOS / ESPAÇOS ABERTOS

Color perfil / Cor perfil: Bronce Satinado
Cristal templado / Vidro temperado: Flute



MOON - MINIPISCINAS OUTDOOR SPA

Panel Arcilla - Painei Argila : Polvo





VITA - MINIPISCINAS OUTDOOR SPA

Paneles arcilla - *Painéis argila: Polvo*



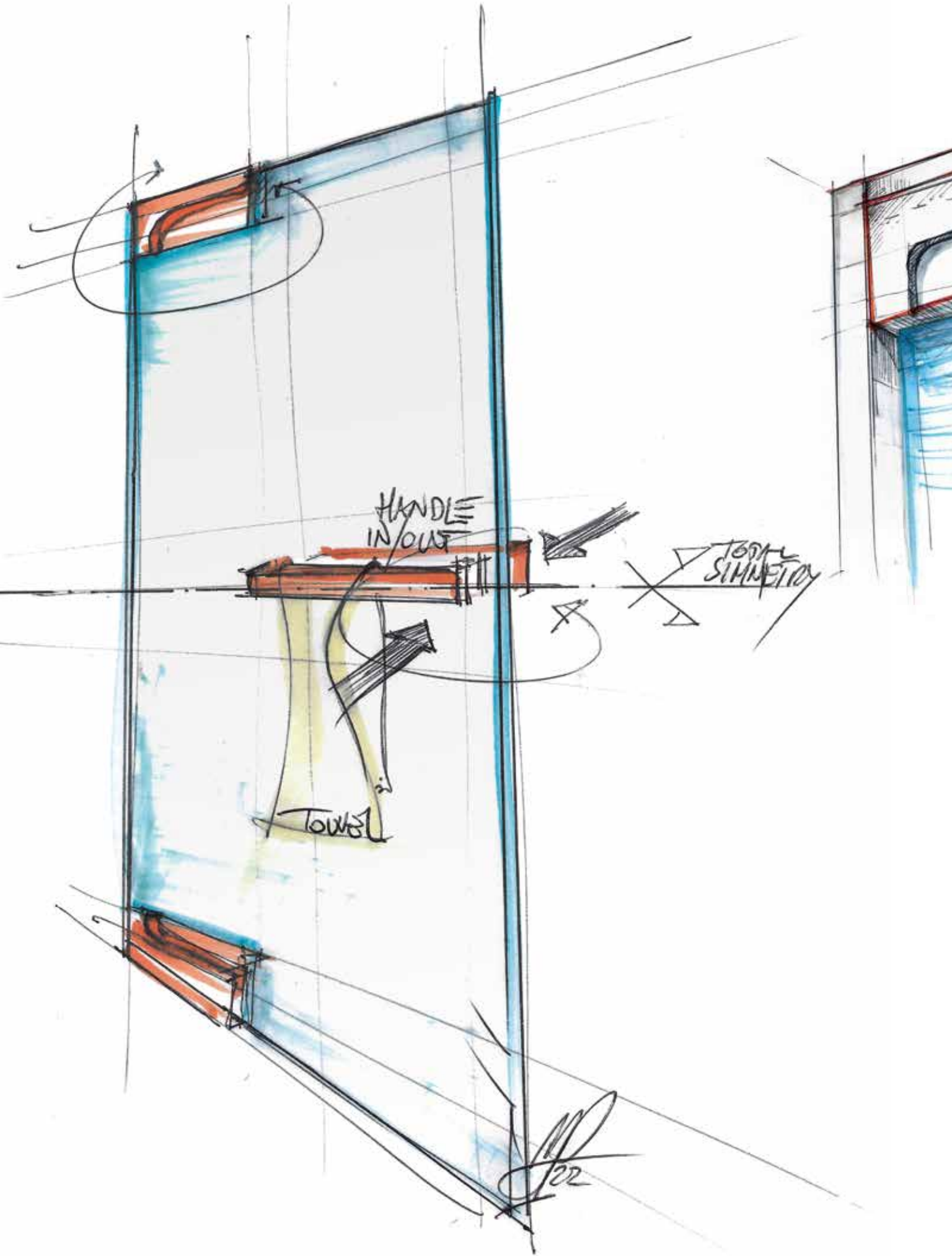

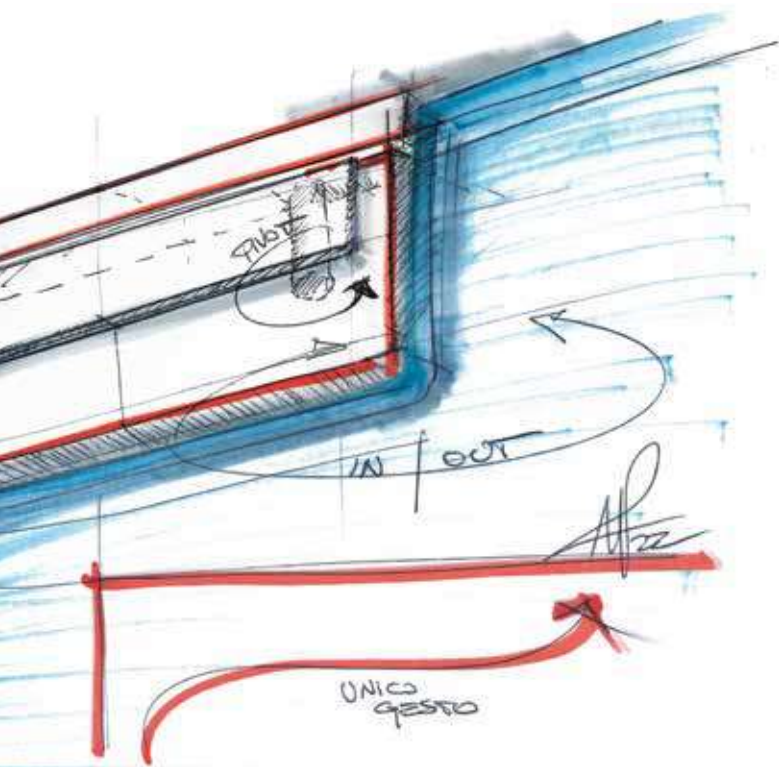

MAMPARAS RESGUARDOS

UNA SOLUCIÓN IDEAL
PARA CADA DESEO,
PARA CADA NIVEL DE
EXIGENCIA Y PARA
CADA GUSTO.

UMA SOLUÇÃO IDEAL
PARA CADA DESEJO,
PARA CADA NÍVEL DE
DEMANDA E PARA
CADA GOSTO.

La síntesis entre comodidad y estilo en un objeto de diseño perfeccionado con las últimas innovaciones tecnológicas, que garantiza un rendimiento estable y seguro a largo plazo y decenas de miles de opciones de personalización.

Cuando se elige una mampara Novellini se conquista un espacio de baño de diseño, pero además fácil de instalar, usar y de mantener en perfecto estado.

La amplia gama de acabados, colores para los perfiles y cristales permite aplicar ese toque personal y exclusivo..

A síntese entre conforto e estilo em um objeto de design aperfeiçoado com as mais recentes inovações tecnológicas, o que garante um desempenho estável e seguro de longo prazo e dezenas de milhares de opções de personalização. Ao escolher um resguardo Novellini, um espaço de design do banho é garantido, mas também fácil de instalar, usar e manter em perfeitas condições.

A ampla gama de acabamentos, cores para os perfis e cristais permite aplicar o toque certo de cada pessoa.

OPERA

DÉJATE ENVOLVER. ES ARTE DISEÑADO PARA TI.
DEIXA-TE ACOLHER. É ARTE PROJETADO PARA VOCÊ.



◀ Soft-closing de doble dirección en apertura y cierre; deslizamiento con cojinetes de esfera.

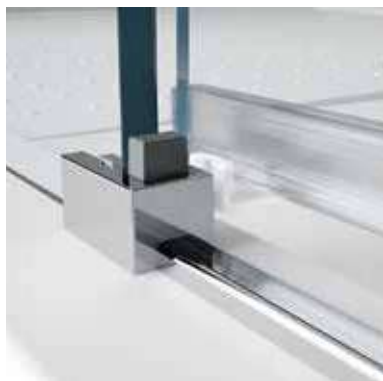

◀ Sistema de liberación de puertas para una fácil limpieza.
Sistema de liberação das portas para uma fácil limpeza.



◀ Nuevo sistema de unión entre frontal y fijo lateral para el modelo PH+FH



Tecnología y estética se funden en esta serie para aportar una mezcla de elegancia y comodidad de uso. El tirador integrado en el cristal regala una placentera y cómoda sensación al tacto, mientras que la liberación de puertas facilita las tareas de limpieza y mantenimiento. El cristal, con 8 mm de espesor y tratamiento Crystal Clear, puede ser transparente o con una delicada serigrafía.

A tecnologia e a estética caracterizam esta série e combinam detalhes de elegância e conforto. As formas são essenciais, a estrutura é sólida, os volumes são regulares. O puxador colocado em ambos os lados proporcionam uma sensação agradável e confortável aveludada ao toque, enquanto o sistema de liberação da porta deslizante garante fácil limpeza e manutenção. O vidro, com oito milímetros de espessura e fiável com o tratamento anti-gota Crystal Clear, pode ser escolhido de forma transparente ou enriquecido por uma impressão de serigrafia refinada.

TRATAMIENTOS / TRATAMENTOS





CONSULTA LA POSIBILIDAD DE FABRICAR LAS MEDIDAS QUE NO ENCUENTRES EN LA TARIFA

OPERA

OPERA 2PH



200 cm



8 mm



3 cm



Soft closing
/ opening



MAMPARA DE 2 HOJAS: 1 CORREDERA + 1 FIJA
RESGUARDO DE 2 FOLHAS: 1 DE CORRER + 1 FIXA

Medidas			Código	Derecha Direita	Izquierda Esquerda	Selección Cristales Seleção Vidros		Selección de perfiles Seleção de perfis			
Medidas extensibilidad Medidas extensibilidade	Fijo frontal Fixo frontal	Entrada				1	51	U	B	K	H
A	F1	*		D-	S-	Transparente	Ser. Ravenna	Blanco mate Branco mate	Silver Abrillantado	Cromo	Negro mate
97↔100	51	37	OPE2PH97	D-	S-	+ 40 €		1.137 €	1.196 €	1.327 €	1.327 €
100↔103	52,5	38,5	OPE2PH100	D-	S-			1.227 €	1.290 €	1.433 €	1.433 €
117↔120	61	47	OPE2PH117	D-	S-			1.319 €	1.386 €	1.539 €	1.539 €
120↔123	62,5	48,5	OPE2PH120	D-	S-			1.391 €	1.462 €	1.622 €	1.622 €
137↔140	71	57	OPE2PH137	D-	S-			1.461 €	1.532 €	1.703 €	1.703 €
140↔143	72,5	58,5	OPE2PH140	D-	S-			1.505 €	1.582 €	1.754 €	1.754 €
147↔150	76	62	OPE2PH147	D-	S-			1.551 €	1.627 €	1.806 €	1.806 €
150↔153	77,5	63,5	OPE2PH150	D-	S-			1.572 €	1.651 €	1.834 €	1.834 €
157↔160	81	67	OPE2PH157	D-	S-			1.595 €	1.675 €	1.860 €	1.860 €
160↔163	82,5	68,5	OPE2PH160	D-	S-			1.641 €	1.721 €	1.911 €	1.911 €
167↔170	86	72	OPE2PH167	D-	S-			1.685 €	1.769 €	1.965 €	1.965 €
170↔173	87,5	73,5	OPE2PH170	D-	S-			1.732 €	1.820 €	2.021 €	2.021 €
177↔180	91	77	OPE2PH177	D-	S-			1.780 €	1.869 €	2.074 €	2.074 €
180↔183	92,5	78,5	OPE2PH180	D-	S-			1.825 €	1.916 €	2.127 €	2.127 €
197↔200	101	87	OPE2PH197	D-	S-			1.870 €	1.964 €	2.178 €	2.178 €
200↔203	102,5	88,5	OPE2PH200	D-	S-			1.915 €	2.011 €	2.233 €	2.233 €

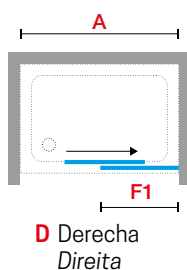
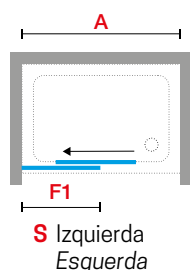
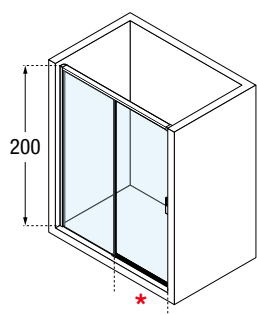

CRISTAL TEMPLADO / VIDRO TEMPERADO

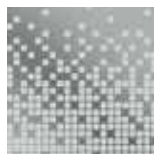

Transparente
cod. 1



Ser. Ravenna
cod. 51

COLORES PERFILES / CORES PERFÍS

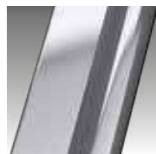
Blanco mate
Branco mate
cod. U



Silver
Abrillantado
cod. B



Cromo
cod. K



Negro mate
cod. H

OPERA PH+FH



MAMPARA DE 2 HOJAS: 1 CORREDERA + 1 FIJA + PANEL FIJO LATERAL SIN PERFIL ANGULAR
ANGULAR DE DUAS PORTS DE CORRER + DOS FIXOS

Medidas				Código	Derecha Direita	Izquierda Esquerda	Selección Cristales Seleção Vidros		Selección de perfiles Seleção de perfis			
Medidas extensibilidad Medidas extensibilidade	Medidas extensibilidad para platos a ras de suelo	Fijo frontal Fixo frontal	Entrada		D-	S-	1	51	U	B	K	H
A	G	F1	*				Transparente	Ser. Ravenna	Blanco mate Branco mate	Silver Abrillatado	Cromo	Negro mate
PUERTA / PORTA												
97↔99	95,9↔97,9	48,5	37	OPEPH97	D-	S-			977 €	1.026 €	1.140 €	1.140 €
99↔101	97,9↔99,9	49,5	38	OPEPH99	D-	S-			1.005 €	1.057 €	1.173 €	1.173 €
105↔107	103,9↔105,9	52,5	41	OPEPH105	D-	S-			1.032 €	1.084 €	1.205 €	1.205 €
107↔109	105,9↔107,9	53,5	42	OPEPH107	D-	S-			1.055 €	1.108 €	1.232 €	1.232 €
109↔111	107,9↔109,9	54,5	43	OPEPH109	D-	S-			1.081 €	1.137 €	1.264 €	1.264 €
115↔117	113,9↔115,9	57,5	46	OPEPH115	D-	S-			1.111 €	1.166 €	1.296 €	1.296 €
117↔119	115,9↔117,9	58,5	47	OPEPH117	D-	S-			1.131 €	1.189 €	1.319 €	1.319 €
119↔121	117,9↔119,9	59,5	48	OPEPH119	D-	S-			1.153 €	1.211 €	1.345 €	1.345 €
125↔127	123,9↔125,9	62,5	51	OPEPH125	D-	S-			1.174 €	1.234 €	1.370 €	1.370 €
127↔129	125,9↔127,9	63,5	52	OPEPH127	D-	S-			1.196 €	1.256 €	1.394 €	1.394 €
129↔131	127,9↔129,9	64,5	53	OPEPH129	D-	S-			1.217 €	1.277 €	1.419 €	1.419 €
135↔137	133,9↔135,9	67,5	56	OPEPH135	D-	S-			1.238 €	1.301 €	1.444 €	1.444 €
137↔139	135,9↔137,9	68,5	57	OPEPH137	D-	S-			1.251 €	1.314 €	1.462 €	1.462 €
139↔141	137,9↔139,9	69,5	58	OPEPH139	D-	S-			1.280 €	1.345 €	1.492 €	1.492 €
142↔144	140,9↔142,9	71	59,5	OPEPH142	D-	S-			1.295 €	1.360 €	1.509 €	1.509 €
145↔147	143,9↔145,9	72,5	61	OPEPH145	D-	S-			1.308 €	1.376 €	1.525 €	1.525 €
147↔149	145,9↔147,9	73,5	62	OPEPH147	D-	S-		+ 40 €	1.329 €	1.396 €	1.551 €	1.551 €
149↔151	147,9↔149,9	74,5	63	OPEPH149	D-	S-			1.350 €	1.419 €	1.574 €	1.574 €
152↔154	150,9↔152,9	76	64,5	OPEPH152	D-	S-			1.361 €	1.430 €	1.588 €	1.588 €
155↔157	153,9↔155,9	77,5	66	OPEPH155	D-	S-			1.372 €	1.441 €	1.601 €	1.601 €
157↔159	155,9↔157,9	78,5	67	OPEPH157	D-	S-			1.393 €	1.465 €	1.625 €	1.625 €
159↔161	157,9↔159,9	79,5	68	OPEPH159	D-	S-			1.414 €	1.484 €	1.648 €	1.648 €
162↔164	160,9↔162,9	81	69,5	OPEPH162	D-	S-			1.425 €	1.497 €	1.662 €	1.662 €
165↔167	163,9↔165,9	82,5	71	OPEPH165	D-	S-			1.435 €	1.508 €	1.674 €	1.674 €
167↔169	165,9↔167,9	83,5	72	OPEPH167	D-	S-			1.458 €	1.530 €	1.700 €	1.700 €
169↔171	167,9↔169,9	84,5	73	OPEPH169	D-	S-			1.478 €	1.553 €	1.723 €	1.723 €
175↔177	173,9↔175,9	87,5	76	OPEPH175	D-	S-			1.499 €	1.573 €	1.748 €	1.748 €
177↔179	175,9↔177,9	88,5	77	OPEPH177	D-	S-			1.526 €	1.604 €	1.781 €	1.781 €
179↔181	177,9↔179,9	89,5	78	OPEPH179	D-	S-			1.590 €	1.672 €	1.855 €	1.855 €
195↔197	193,9↔195,9	97,5	86	OPEPH195	D-	S-			1.611 €	1.693 €	1.879 €	1.879 €
197↔199	195,9↔197,9	98,5	87	OPEPH197	D-	S-			1.632 €	1.715 €	1.905 €	1.905 €
199↔201	197,9↔199,9	99,5	88	OPEPH199	D-	S-			1.654 €	1.738 €	1.929 €	1.929 €
FIJO PANEL / FIXO PAINEL												
					FD	FS						
67↔69	65,9↔67,9	-	-	OPEFH67	D-	S-			449 €	472 €	524 €	524 €
69↔71	67,9↔69,9	-	-	OPEFH69	D-	S-			476 €	500 €	555 €	555 €
73↔75	71,9↔73,9	-	-	OPEFH73	D-	S-			495 €	522 €	578 €	578 €
75↔77	73,9↔75,9	-	-	OPEFH75	D-	S-			514 €	541 €	602 €	602 €
77↔79	75,9↔77,9	-	-	OPEFH77	D-	S-			541 €	570 €	633 €	633 €
79↔81	77,9↔79,9	-	-	OPEFH79	D-	S-			555 €	583 €	650 €	650 €
85↔87	83,9↔85,9	-	-	OPEFH85	D-	S-			582 €	613 €	678 €	678 €
87↔89	85,9↔87,9	-	-	OPEFH87	D-	S-			594 €	623 €	693 €	693 €
89↔91	87,9↔89,9	-	-	OPEFH89	D-	S-		+ 40 €	622 €	654 €	724 €	724 €
95↔97	93,9↔95,9	-	-	OPEFH95	D-	S-			633 €	666 €	740 €	740 €
97↔99	95,9↔97,9	-	-	OPEFH97	D-	S-			659 €	693 €	769 €	769 €
99↔101	97,9↔99,9	-	-	OPEFH99	D-	S-			673 €	708 €	787 €	787 €
105↔107	103,9↔105,9	-	-	OPEFH105	D-	S-			710 €	746 €	830 €	830 €
107↔109	105,9↔107,9	-	-	OPEFH107	D-	S-			730 €	766 €	851 €	851 €
115↔117	113,9↔115,9	-	-	OPEFH115	D-	S-			747 €	787 €	873 €	873 €
117↔119	115,9↔117,9	-	-	OPEFH117	D-	S-			773 €	813 €	903 €	903 €
119↔121	117,9↔119,9	-	-	OPEFH119	D-	S-			800 €	841 €	933 €	933 €
H = 200 L 53↔119				ESPECIAL OPEFHSP					964 €	1.011 €	1.120 €	1.120 €

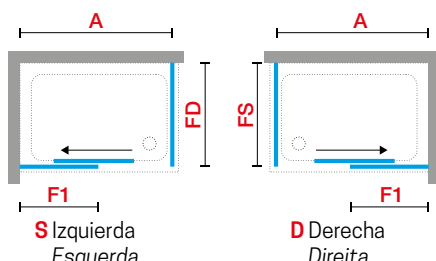
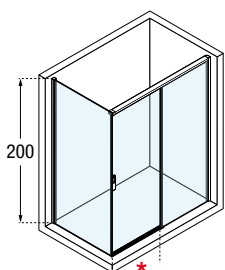

IMPORTANTE!
INDICAR EN PEDIDO
SI EL PLATO ES
SOBREELEVADO O A
RAS DE SUELO
INDICAR NA
ENCOMENDA SE
A BASE E SOBRE
ELEVADO O A NIVEL
DO CHÃO

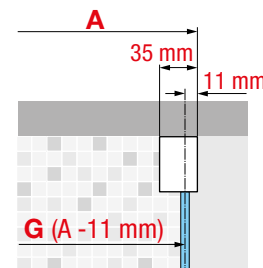

CRISTAL TEMPLADO / VIDRO TEMPERADO

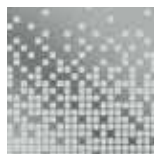

Transparente
cod. 1



Ser. Ravenna
cod. 51

COLORES PERFILES / CORES PERFÍS

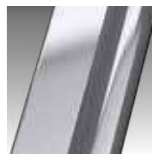
Blanco mate
Branco mate
cod. U



Silver
Abrillantado
cod. B



Cromo
cod. K



Negro mate
cod. H

OPERA 2P



PUERTA DE DOS HOJAS: UNA CORREDERA + UNA FIJA
RESGUARDO DE DUAS FOLHAS: UNA DE CORRER + UNA FIXA

Medidas				Código	Derecha Direita	Izquierda Esquerda	Selección Cristales Seleção Vidros		Selección de perfiles Seleção de perfis			
Medidas extensibilidad Medidas extensibilidade	Medidas extensibilidad para platos a ras de suelo	Fijo frontal Fixo frontal	Entrada		D-	S-	1	51	U	B	K	H
A	G	F1	*				Transparente	Ser. Ravenna	Blanco mate Branco mate	Silver Abrillantado	Cromo	Negro mate
PUERTA / PORTA												
97↔101	95,9↔99,9	48,5	37	OPE2P97	D-	S-						
107↔111	105,9↔109,9	53,5	42	OPE2P107	D-	S-						
117↔121	115,9↔119,9	58,5	47	OPE2P117	D-	S-						
137↔141	135,9↔139,9	68,5	57	OPE2P137	D-	S-						
147↔151	145,9↔149,9	73,5	62	OPE2P147	D-	S-						
157↔161	155,9↔159,9	78,5	67	OPE2P157	D-	S-						
167↔171	165,9↔169,9	83,5	72	OPE2P167	D-	S-						
177↔181	175,9↔179,9	88,5	77	OPE2P177	D-	S-						
FIJO PANEL / FIXO PAINEL												
F												
67↔69	65,9↔67,9			OPEF67-	-	-						
69↔71	67,9↔69,9			OPEF69-	-	-						
73↔75	71,9↔73,9			OPEF73-	-	-						
75↔77	73,9↔75,9			OPEF75-	-	-						
77↔79	75,9↔77,9			OPEF77-	-	-						
79↔81	77,9↔79,9			OPEF79-	-	-						
85↔87	83,9↔85,9			OPEF85-	-	-						
87↔89	85,9↔87,9			OPEF87-	-	-						
89↔91	87,9↔89,9			OPEF89-	-	-						
95↔97	93,9↔95,9			OPEF95-	-	-						
97↔99	95,9↔97,9			OPEF97-	-	-						
99↔101	97,9↔99,9			OPEF99-	-	-						
105↔107	103,9↔105,9			OPEF105-	-	-						
107↔109	105,9↔107,9			OPEF107-	-	-						
115↔117	113,9↔115,9			OPEF115-	-	-						
117↔119	115,9↔117,9			OPEF117-	-	-						
119↔121	117,9↔119,9			OPEF119-	-	-						
H = 200 L 67↔119			ESPECIAL	OPEFSP	-	-						
									1.065 €	1.120 €	1.243 €	1.243 €

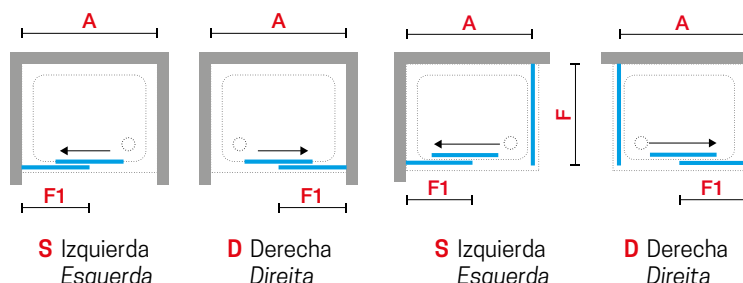
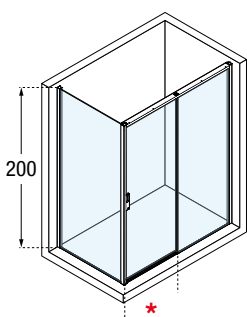

¡IMPORTANTE!
INDICAR EN PEDIDO
SI EL PLATO ES
SOBREELEVADO O A
RAS DE SUELO
INDICAR NA
ENCOMENDA SE
A BASE E SOBRE
ELEVADO O A NIVEL
DO CHÃO

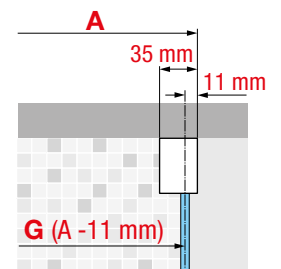

CRISTAL TEMPLADO / VIDRO TEMPERADO

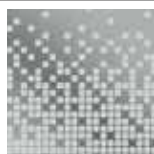
 Transparente
cod. 1

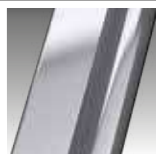
 Ser. Ravenna
cod. 51
COLORES PERFILES / CORES PERFÍS

 Blanco mate
 Branco mate
cod. U

 Silver
 Abridantado
cod. B

 Cromo
cod. K

 Negro mate
cod. H

OPERA 2A



FRONTAL DE DOS HOJAS CORREDERAS + DOS FIJOS RESGUARDO DE DUAS FOLHAS DE CORRER + DOS FIXOS

Medidas				Código	Selección Cristales Seleção Vidros		Selección de perfiles Seleção de perfis			
Medidas extensibilidad Medidas extensibilidade	Medidas extensibilidad para platos a ras de suelo	Fijo frontal Fijo frontal	Entrada		1	51	U	B	K	H
A	G	F1	*		Transparente	Ser. Ravenna	Blanco mate Branco mate	Silver Abrillantado	Cromo	Negro mate
PUERTA / PORTA										
117↔121	115,9↔119,9	31	45	OPE2A117-			1.431 €	1.504 €	1.668 €	1.668 €
121↔125	119,9↔123,9	32	47	OPE2A121-			1.431 €	1.504 €	1.668 €	1.668 €
125↔129	123,9↔127,9	33	49	OPE2A125-			1.547 €	1.625 €	1.804 €	1.804 €
129↔133	127,9↔131,9	34	51	OPE2A129-			1.547 €	1.625 €	1.804 €	1.804 €
133↔137	131,9↔135,9	35	53	OPE2A133-			1.547 €	1.625 €	1.804 €	1.804 €
137↔141	135,9↔139,9	36	52	OPE2A137-			1.664 €	1.748 €	1.940 €	1.940 €
141↔145	139,9↔143,9	37	54	OPE2A141-			1.664 €	1.748 €	1.940 €	1.940 €
145↔149	143,9↔147,9	38	56	OPE2A145-			1.664 €	1.748 €	1.940 €	1.940 €
149↔153	147,9↔151,9	39	58	OPE2A149-		+ 80 €	1.721 €	1.807 €	2.008 €	2.008 €
153↔157	151,9↔155,9	40	60	OPE2A153-			1.721 €	1.807 €	2.008 €	2.008 €
157↔161	155,9↔159,9	41	62	OPE2A157-			1.721 €	1.807 €	2.008 €	2.008 €
161↔165	159,9↔163,9	42	64	OPE2A161-			1.781 €	1.870 €	2.075 €	2.075 €
165↔169	163,9↔167,9	43	66	OPE2A165-			1.781 €	1.870 €	2.075 €	2.075 €
169↔173	167,9↔171,9	44	68	OPE2A169-			1.781 €	1.870 €	2.075 €	2.075 €
173↔177	171,9↔175,9	45	70	OPE2A173-			1.841 €	1.933 €	2.149 €	2.149 €
177↔181	175,9↔179,9	46	72	OPE2A177-			1.841 €	1.933 €	2.149 €	2.149 €
197↔201	195,9↔199,9	51	82	OPE2A197-			1.902 €	1.997 €	2.218 €	2.218 €
FIJO PANEL / FIXO PAINEL										
				F						
67↔69	65,9↔67,9			OPEF67-			500 €	525 €	583 €	583 €
69↔71	67,9↔69,9			OPEF69-			530 €	557 €	619 €	619 €
73↔75	71,9↔73,9			OPEF73-			551 €	580 €	644 €	644 €
75↔77	73,9↔75,9			OPEF75-			572 €	602 €	668 €	668 €
77↔79	75,9↔77,9			OPEF77-			602 €	633 €	704 €	704 €
79↔81	77,9↔79,9			OPEF79-			618 €	650 €	720 €	720 €
85↔87	83,9↔85,9			OPEF85-			647 €	678 €	755 €	755 €
87↔89	85,9↔87,9			OPEF87-			660 €	694 €	771 €	771 €
89↔91	87,9↔89,9			OPEF89-		+ 40 €	692 €	725 €	806 €	806 €
95↔97	93,9↔95,9			OPEF95-			704 €	740 €	822 €	822 €
97↔99	95,9↔97,9			OPEF97-			734 €	769 €	853 €	853 €
99↔101	97,9↔99,9			OPEF99-			749 €	788 €	875 €	875 €
105↔107	103,9↔105,9			OPEF105-			790 €	831 €	922 €	922 €
107↔109	105,9↔107,9			OPEF107-			810 €	851 €	946 €	946 €
115↔117	113,9↔115,9			OPEF115-			831 €	873 €	969 €	969 €
117↔119	115,9↔117,9			OPEF117-			859 €	903 €	1.004 €	1.004 €
119↔121	117,9↔119,9			OPEF119-			888 €	933 €	1.037 €	1.037 €
H = 200 L 67↔119			ESPECIAL	OPEFSP		-	1.065 €	1.120 €	1.243 €	1.243 €

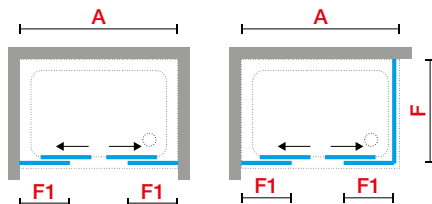
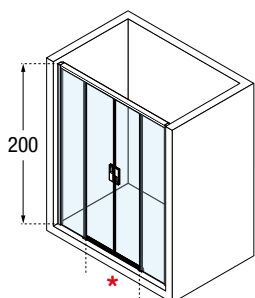

IMPORTANTE!
INDICAR EN PEDIDO SI EL PLATO ES SOBREELEVADO O A RAS DE SUELO
INDICAR NA ENCOMENDA SE A BASE E SOBRE ELEVADO O A NIVEL DO CHÃO

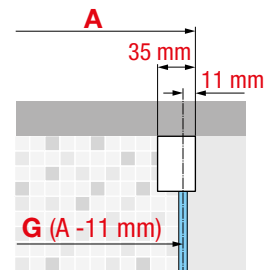

CRISTAL TEMPLADO / VIDRO TEMPERADO

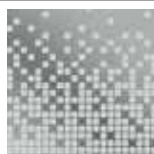

Transparente
cod. 1



Ser. Ravenna
cod. 51

COLORES PERFILES / CORES PERFÍS

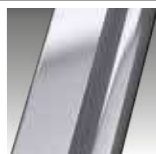
Blanco mate
Branco mate
cod. U



Silver
Abrillantado
cod. B



Cromo
cod. K



Negro mate
cod. H

OPERA A



200 cm

8 mm

2 cm

Soft closing / opening

ANGULAR DE DOS PUERTAS CORREDERAS + DOS FIJOS ANGULAR DE DUAS PORTS DE CORRER + DOS FIXOS

Medidas				Código	Derecha Direita	Izquierda Esquerda	Selección Cristales Seleção Vidros		Selección de perfiles Seleção de perfis				
Medidas extensibilidad Medidas extensibilidade	Medidas extensibilidad para platos a ras de suelo	Fijo frontal Fixo frontal	Entrada				1	51	U	B	K	H	
A	G	F1	*				Transparente	Ser. Ravenna	Blanco mate Branco mate	Silver Abrillantado	Cromo	Negro mate	
67↔69	65,9↔67,9	33,5	32	OPEA67L	D-	S-							
69↔71	67,9↔69,9	34,5	34	OPEA69L	D-	S-							
75↔77	73,9↔75,9	37,5	38	OPEA75L	D-	S-							
77↔79	75,9↔77,9	38,5	39	OPEA77L	D-	S-							
79↔81	77,9↔79,9	39,5	41	OPEA79L	D-	S-							
85↔87	83,9↔85,9	42,5	45	OPEA85L	D-	S-							
87↔89	85,9↔87,9	43,5	46	OPEA87L	D-	S-							
89↔91	87,9↔89,9	44,5	48	OPEA89L	D-	S-							
95↔97	93,9↔95,9	47,5	52	OPEA95L	D-	S-							
97↔99	95,9↔97,9	48,5	53	OPEA97L	D-	S-							
99↔101	97,9↔99,9	49,5	55	OPEA99L	D-	S-							
115↔117	113,9↔115,9	65,5	58	OPEA115L	D-	S-							
117↔119	115,9↔117,9	66,5	60	OPEA117L	D-	S-							
119↔121	117,9↔119,9	67,5	62	OPEA119L	D-	S-							
								+ 40 €		681 €	716 €	795 €	795 €
										681 €	716 €	795 €	795 €
										709 €	746 €	829 €	829 €
										709 €	746 €	829 €	829 €
										709 €	746 €	829 €	829 €
										741 €	779 €	864 €	864 €
										741 €	779 €	864 €	864 €
										741 €	779 €	864 €	864 €
										769 €	808 €	898 €	898 €
										769 €	808 €	898 €	898 €
										798 €	840 €	933 €	933 €
										885 €	932 €	1.034 €	1.034 €
										930 €	977 €	1.083 €	1.083 €
										930 €	977 €	1.083 €	1.083 €

PARA COMPONER UN ÁNGULO PEDIR 2 LATERALES FORMAR UM ÂNGULO PEDINDO DOIS LATERAIS

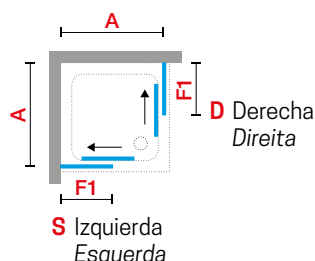
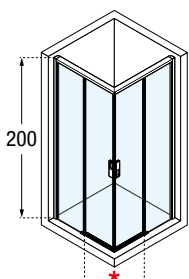

¡IMPORTANTE!
INDICAR EN PEDIDO SI EL PLATO ES SOBREELEVADO O A RAS DE SUELO
INDICAR NA ENCOMENDA SE A BASE E SOBRE ELEVADO O A NIVEL DO CHÃO

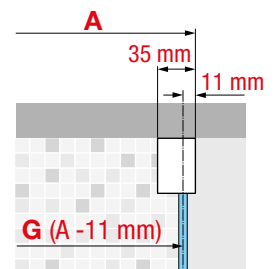

030

Construcción del código:
Construção do código

Código

+ Izquierda / Derecha
+ Esquerda / Direita

+ Cristales
+ Vidros

+ Perfiles
+ Perfis

= Código completo del producto
= Código completo do produto

CRISTAL TEMPLADO / VIDRO TEMPERADO

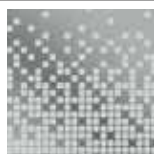

Transparente
cod. 1



Ser. Ravenna
cod. 51

COLORES PERFILES / CORES PERFÍS

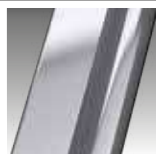
Blanco mate
Branco mate
cod. U



Silver
Abrillantado
cod. B



Cromo
cod. K



Negro mate
cod. H

DATOS TÉCNICOS / DADOS TÉCNICOS

COLORES PERFILES / CORES PERFÍS



Blanco Mate
Branco Mate
cod. U



Silver
Abrillantado
cod. B



Cromo
cod. K



Negro mate
cod. H

CRISTAL TEMPLADO / VIDRO TEMPERADO 8 mm (Según norma Europea UNE EN 14428)



Transparente
cod. 1



SERIGRAFIA

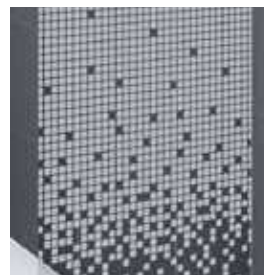

Ravenna
cod. 51

TIRADOR / PUXADOR



Tirador metálico
blanco, negro o cromo
Puxador metálico
branco, negro o cromo

MEDIDAS QUE OCUPAN LOS PERFILES EN LA PARED / ESPAÇO QUE OCUPAN OS PERFÍS NA PAREDE

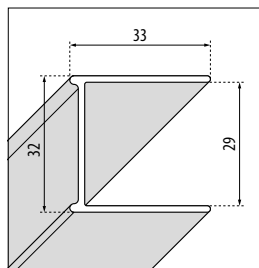

A PARED

por Opera PH - 2P - A - 2PH

Altura	Color perfil Cor perfil	Código
1999	Blanco / Branco	P01BXMOST-U
	Silver / Abrillantado	P01BXMOST-B
	Cromo	P01BXMOST-K
	Negro mate	P01BXMOST-H

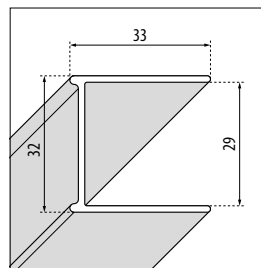

A PARED

por Opera FH

Altura	Color perfil Cor perfil	Código
2002	Blanco / Branco	P01BXFHST-U
	Silver / Abrillantado	P01BXFHST-B
	Cromo	P01BXFHST-K
	Negro mate	P01BXMOST-H

TOMA DE MEDIDAS

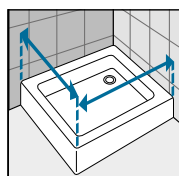

Tomar las medidas desde la pared hasta el borde externo del plato de ducha.
Medir a distância desde a parede até o rebordo externo da base de chuveiro.

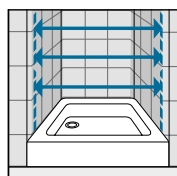

Tomar medidas de pared a pared, medir la parte baja, la central y la superior. Cursar el pedido con la medida más pequeña.
Medir a distância entre paredes, tem que tirar três medidas (inferior, superior e central) e utilizar a inferior. Encomendar pedido da medida mais pequena.



KUADRA 2.0

MINIMALISMO
GEOMÉTRICO Y SENSACIÓN
DE BIENESTAR.

MINIMALISMO GEOMÉTRICO
E SENSATÕES BEM-ESTAR.



◀ Sistema de deslizamiento mediante rodamientos con cojinetes de esfera.
Sistema de deslizamento de rolamentos de esfera.



◀ Sistema oculto de fijación a pared con compensación de desnivel.



◀ Nuevo sistema de unión entre frontal y panel fijo lateral en el modelo PH+FH



TRATAMIENTOS / TRATAMENTOS



CONFIGURA ESTA SERIE EN
[HTTP://WWW.NOVELLINI.COM/KUADRA20](http://www.novellini.com/kuadra20)



CONSULTA LA POSIBILIDAD DE FABRICAR LAS MEDIDAS QUE NO ENCUENTRES EN LA TARIFA

KUADRA 2.0

KUADRA 2.0 PH+FH



MAMPARA DE 2 HOJAS: 1 CORREDERA + 1 FIJA + PANEL FIJO LATERAL SIN PERFIL ANGULAR

RESGUARDO DE 2 FOLHIAS: 1 DE CORRER + 1 FIJA + PAINEL FIXO LATERAL

Medidas				Código	Derecha	Izquierda	Selección Cristales		Selección de perfiles				
Medidas extensibilidad	Medidas extensibilidad	Fijo frontal	Entrada		Direita	Esquerda	Seleção Vidros	1	56	U	B	K	H
Medidas extensibilidad	Medidas para platos a ras de suelo	Medidas Fijo frontal	*		D-	S-	Transparente	Ser. Rose 1	Blanco mate	Silver	Cromo	Negro mate	Inox satinado

PUERTA / PORTA														
107↔109	106↔108	52	45	K2PH107	D-	S-			930 €	1.025 €	1.127 €	1.127 €	1.352 €	
109↔111	108↔110	54	45	K2PH109	D-	S-			949 €	1.044 €	1.154 €	1.154 €	1.385 €	
117↔119	116↔118	57	50	K2PH117	D-	S-			970 €	1.073 €	1.181 €	1.181 €	1.417 €	
119↔121	118↔120	59	50	K2PH119	D-	S-			990 €	1.092 €	1.202 €	1.202 €	1.443 €	
127↔129	126↔128	62	55	K2PH127	D-	S-			1.011 €	1.113 €	1.229 €	1.229 €	1.474 €	
129↔131	128↔130	64	55	K2PH129	D-	S-			1.031 €	1.142 €	1.256 €	1.256 €	1.507 €	
137↔139	136↔138	67	60	K2PH137	D-	S-			1.053 €	1.161 €	1.277 €	1.277 €	1.533 €	
139↔141	138↔140	69	60	K2PH139	D-	S-			1.073 €	1.181 €	1.304 €	1.304 €	1.565 €	
147↔149	146↔148	72	65	K2PH147	D-	S-	+ 40 €		1.092 €	1.202 €	1.325 €	1.325 €	1.590 €	
149↔151	148↔150	74	65	K2PH149	D-	S-			1.120 €	1.237 €	1.365 €	1.365 €	1.638 €	
157↔159	156↔158	77	70	K2PH157	D-	S-			1.142 €	1.256 €	1.386 €	1.386 €	1.663 €	
159↔161	158↔160	79	70	K2PH159	D-	S-			1.154 €	1.270 €	1.399 €	1.399 €	1.679 €	
167↔169	166↔168	82	75	K2PH167	D-	S-			1.174 €	1.297 €	1.428 €	1.428 €	1.713 €	
169↔171	168↔170	84	75	K2PH169	D-	S-			1.202 €	1.325 €	1.462 €	1.462 €	1.754 €	
177↔179	176↔178	87	80	K2PH177	D-	S-			1.229 €	1.352 €	1.488 €	1.488 €	1.786 €	
179↔181	178↔180	89	80	K2PH179	D-	S-			1.256 €	1.386 €	1.530 €	1.530 €	1.835 €	
H 140↔220														
L 107↔200		ESPECIAL		K2PHSP			-		1.511 €	1.663 €	1.836 €	1.836 €	2.203 €	

FIJO PANEL / FIXO PAINEL														
67↔69	66↔68	-	-	K2FH67-	-	-			424 €	472 €	519 €	519 €	623 €	
69↔71	68↔70	-	-	K2FH69-	-	-			424 €	472 €	519 €	519 €	623 €	
71↔73	70↔72	-	-	K2FH71-	-	-			424 €	472 €	519 €	519 €	623 €	
72↔74	71↔73	-	-	K2FH72-	-	-			444 €	492 €	546 €	546 €	655 €	
74↔76	73↔75	-	-	K2FH74-	-	-			444 €	492 €	546 €	546 €	655 €	
76↔78	75↔77	-	-	K2FH76-	-	-			444 €	492 €	546 €	546 €	655 €	
77↔79	76↔78	-	-	K2FH77-	-	-			465 €	513 €	567 €	567 €	681 €	
79↔81	78↔80	-	-	K2FH79-	-	-			465 €	513 €	567 €	567 €	681 €	
81↔83	80↔82	-	-	K2FH81-	-	-			465 €	513 €	567 €	567 €	681 €	
85↔87	84↔86	-	-	K2FH85-	-	-			492 €	546 €	602 €	602 €	722 €	
87↔89	86↔88	-	-	K2FH87-	-	-			492 €	546 €	602 €	602 €	722 €	
89↔91	88↔90	-	-	K2FH89-	-	-			492 €	546 €	602 €	602 €	722 €	
91↔93	90↔92	-	-	K2FH91-	-	-	+ 40 €		513 €	567 €	629 €	629 €	754 €	
95↔97	94↔96	-	-	K2FH95-	-	-			513 €	567 €	629 €	629 €	754 €	
97↔99	96↔98	-	-	K2FH97-	-	-			533 €	587 €	650 €	650 €	779 €	
99↔101	98↔100	-	-	K2FH99-	-	-			533 €	587 €	650 €	650 €	779 €	
101↔103	100↔102	-	-	K2FH101-	-	-			533 €	587 €	650 €	650 €	779 €	
105↔107	104↔106	-	-	K2FH105-	-	-			561 €	622 €	691 €	691 €	829 €	
107↔109	106↔108	-	-	K2FH107-	-	-			561 €	622 €	691 €	691 €	829 €	
109↔111	108↔110	-	-	K2FH109-	-	-			561 €	622 €	691 €	691 €	829 €	
111↔113	110↔112	-	-	K2FH111-	-	-			581 €	643 €	710 €	710 €	852 €	
115↔117	114↔116	-	-	K2FH115-	-	-			581 €	643 €	710 €	710 €	852 €	
117↔119	116↔118	-	-	K2FH117-	-	-			608 €	670 €	739 €	739 €	886 €	
119↔121	118↔120	-	-	K2FH119-	-	-			608 €	670 €	739 €	739 €	886 €	
121↔123	120↔122	-	-	K2FH121-	-	-			608 €	670 €	739 €	739 €	886 €	
H 140↔220														
L 65↔123		ESPECIAL		K2FHSP	-	-	-		729 €	802 €	888 €	888 €	1.065 €	

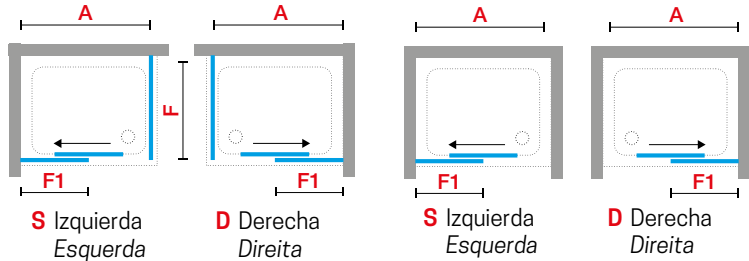
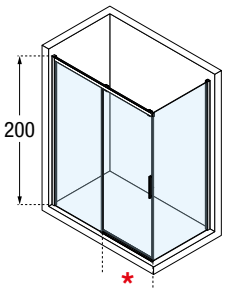

IMPORTANTE!
INDICAR EN PEDIDO SI EL PLATO ES SOBREELEVADO O A RAS DE SUELO
INDICAR NA ENCOMENDA SE A BASE E SOBRE ELEVADO O A NIVEL DO CHÃO

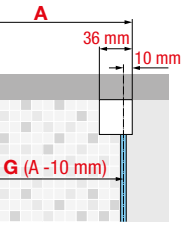



OPTIONAL

KIT DE MONTAJE A AÑADIR para versión entre paredes

Color Cores	Version	Código	Precio Preço
Blanco mate Branco mate	Derecha Direita	K2PHPND-U	104 €
Cromo	Derecha Direita	K2PHPND-K	110 €
Negro mate	Derecha Direita	K2PHPND-H	117 €
Inox satinado	Derecha Direita	K2PHPND-Z	155 €
Blanco mate Branco mate	Izquierda Esquerda	K2PHPNS-U	104 €
Cromo	Izquierda Esquerda	K2PHPNS-K	110 €
Negro mate	Izquierda Esquerda	K2PHPNS-H	117 €
Inox satinado	Izquierda Esquerda	K2PHPNS-Z	155 €

CRISTAL TEMPLADO / VIDRO TEMPERADO



Transparente
cod 1



Ser. Rose 1
cod 56

COLORES PERFILES / CORES PERFÍS



Blanco Mate
Branco Mate
cod. U

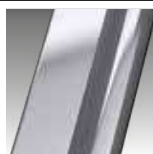

Silver
Abrillantado
cod. B



Cromo
cod. K



Negro mate
cod. H



Inox satinado
cod Z

KUADRA 2.0 2PH



MAMPARA DE 2 HOJAS: 1 CORREDERA + 1 FIJA + PANEL FIJO LATERAL
RESGUARDO DE 2 FOLHAS: 1 DE CORRER + 1 FIXA + PAINEL FIXO LATERAL

Medidas				Código	Derecha	Izquierda	Selección Cristales		Selección de perfiles				
Medidas extensibilidad	Medidas extensibilidad para platos a ras de suelo	Fijo frontal	Entrada		Dereita	Esquerda	Seleção Vidros	1	56	U	B	K	H
A	G	F1	*		D-	S-	Transparente	Ser. Rose 1	Blanco mate	Silver	Cromo	Negro mate	Inox satinado
97↔101	96↔100	47	40	K22PH97	D-	S-			Branco mate	Abrillantado			
107↔111	106↔110	52	45	K22PH107	D-	S-			1.044 €	1.154 €	1.270 €	1.270 €	1.523 €
117↔121	116↔120	57	50	K22PH117	D-	S-			1.092 €	1.202 €	1.325 €	1.325 €	1.590 €
127↔131	126↔130	62	55	K22PH127	D-	S-			1.142 €	1.256 €	1.386 €	1.386 €	1.663 €
137↔141	136↔140	67	60	K22PH137	D-	S-			1.189 €	1.311 €	1.447 €	1.447 €	1.736 €
147↔151	146↔150	72	65	K22PH147	D-	S-			1.237 €	1.365 €	1.502 €	1.502 €	1.802 €
157↔161	156↔160	77	70	K22PH157	D-	S-			1.285 €	1.414 €	1.557 €	1.557 €	1.869 €
167↔171	166↔170	82	75	K22PH167	D-	S-			1.332 €	1.468 €	1.619 €	1.619 €	1.942 €
177↔181	176↔180	87	80	K22PH177	D-	S-			1.386 €	1.530 €	1.688 €	1.688 €	2.025 €
187↔191	186↔190	97	80	K22PH187	D-	S-			1.441 €	1.590 €	1.754 €	1.754 €	2.105 €
H 140±220 L 97↔200		ESPECIAL		K22PHSP	-	-			1.495 €	1.646 €	1.816 €	1.816 €	2.178 €
									1.796 €	1.975 €	2.187 €	2.187 €	2.624 €

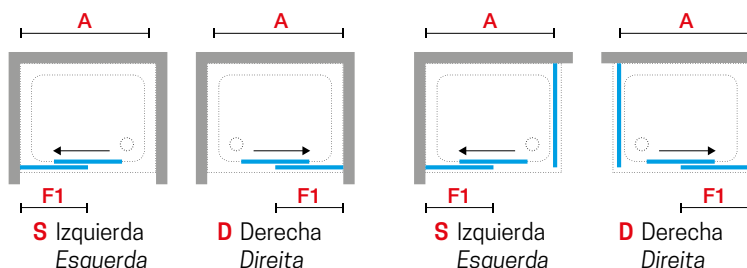
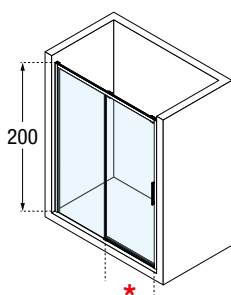

¡IMPORTANTE!
INDICAR EN PEDIDO SI EL PLATO ES SOBREELEVADO O A RAS DE SUELO
INDICAR NA ENCOMENDA SE A BASE E SOBRE ELEVADO O A NIVEL DO CHÃO

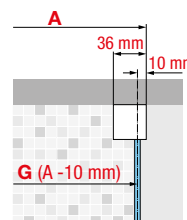



CRISTAL TEMPLADO / VIDRO TEMPERADO



Transparente
cod 1



Ser. Rose 1
cod 56

COLORES PERFILES / CORES PERFÍS



Blanco Mate
Branco Mate
cod. U

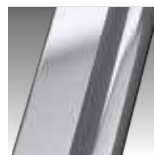

Silver
Abrillantado
cod. B



Cromo
cod. K



Negro mate
cod. H



Inox satinado
cod Z

KUADRA 2.0 2AH

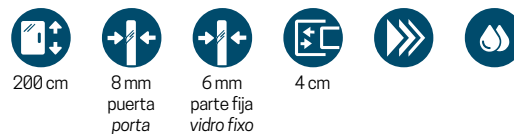

FRONTAL DE DOS HOJAS CORREDERAS + DOS FIJOS

Para instalar entre paredes o con fijo lateral KUADRA 2.0 F

RESGUARDO DE DUAS FOLHAS DE CORRER + DOS FIXOS

Para instalar entre paredes ou com fijo lateral KUADRA 2.0 F

Medidas				Código	Selección Cristales Seleção Vidros		Selección de perfiles Seleção de perfis				
Medidas extensibilidad Medidas extensibilidade	Selección Cristales Seleção Vidros	Fijo frontal Fixo frontal	Entrada		1	56	U	B	K	H	Z
A	G	F1	*		Transparente	Ser. Rose 1	Blanco mate Branco mate	Silver Abrillantado	Cromo	Negro mate	Inox satinado
137↔141	136↔140	33	56	K22AH137-			1.545 €	1.706 €	1.879 €	1.879 €	2.255 €
147↔151	146↔150	36,5	60	K22AH147-			1.594 €	1.753 €	1.935 €	1.935 €	2.321 €
157↔161	156↔160	38,5	66	K22AH157-			1.642 €	1.809 €	1.991 €	1.991 €	2.388 €
167↔171	166↔170	41,5	70	K22AH167-	+ 40 €	+ 40 €	1.691 €	1.865 €	2.053 €	2.053 €	2.463 €
177↔181	176↔180	43,5	76	K22AH177-			1.741 €	1.913 €	2.108 €	2.108 €	2.530 €
187↔191	186↔190	46,5	80	K22AH187-			1.796 €	1.976 €	2.178 €	2.178 €	2.614 €
197↔201	196↔200	48,5	86	K22AH197-			1.852 €	2.039 €	2.247 €	2.247 €	2.697 €

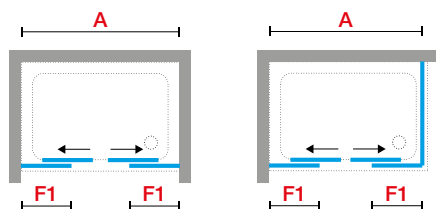
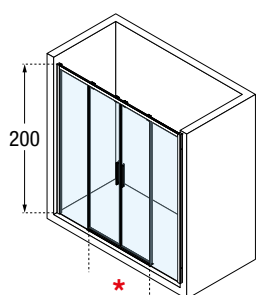

IMPORTANT!
INDICAR EN PEDIDO
SI EL PLATO ES
SOBREELEVADO O A
RAS DE SUELO

INDICAR NA
ENCOMENDA SE
A BASE E SOBRE
ELEVADO O A NIVEL
DO CHÃO

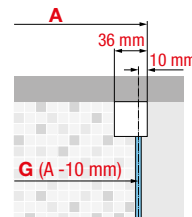



CRISTAL TEMPLADO / VIDRO TEMPERADO



Transparente
cod 1



Ser. Rose 1
cod 56

COLORES PERFILES / CORES PERFÍS



Blanco Mate
Branco Mate
cod. U

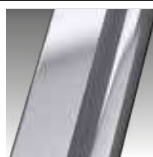

Silver
Abrillantado
cod. B



Cromo
cod. K



Negro mate
cod. H



Inox satinado
cod Z

KUADRA 2.0 G+F EN LÍNEA EM LINHA



MAMPARA DE UNA PUERTA ABATIBLE + FIJO EN LÍNEA

PARA INSTALAR ENTRE PAREDES O CON FIJO LATERAL KUADRA 2.0 F

RESGUARDO DE UNA PORTA ABATÍVELS + FIXO EM LINHA

PARA INSTALAR ENTRE PARADES OU COM FIXO LATERAL KUADRA 2.0 F

Medidas					Código	Selección Cristales Seleção Vidros		Selección de perfiles Seleção de perfis				
Medidas extensibilidad Medidas extensibilidade	Medidas extensibilidad para platos a ras de suelo	Fijo frontal Fixo frontal	Entrada	Espacio de apertura Espaço de abertura		1	56	U	B	K	H	Z
A	G	F1	*	B		Transparente	Ser. Rose 1	Blanco mate Branco mate	Silver Abrilantado	Cromo	Negro mate	Inox satinado
97↔101	96↔100	31	51	52	K2GFL97-	+ 40 €		1.202 €	1.325 €	1.462 €	1.462 €	1.754 €
107↔111	106↔110	31	61	62	K2GFL107-			1.256 €	1.386 €	1.530 €	1.530 €	1.835 €
113↔117	112↔116	38	61	62	K2GFL113-			1.285 €	1.414 €	1.557 €	1.557 €	1.869 €
117↔121	116↔120	41	61	62	K2GFL117-			1.311 €	1.447 €	1.598 €	1.598 €	1.918 €
127↔131	126↔130	51	61	62	K2GFL127-			1.365 €	1.502 €	1.653 €	1.653 €	1.983 €
137↔141	136↔140	51	68	69	K2GFL137-			1.420 €	1.564 €	1.720 €	1.720 €	2.064 €
147↔151	146↔150	61	68	69	K2GFL147-			1.476 €	1.625 €	1.789 €	1.789 €	2.147 €
153↔157	152↔156	68	68	69	K2GFL153-			1.502 €	1.653 €	1.823 €	1.823 €	2.188 €
157↔161	156↔160	71	68	69	K2GFL157-			1.530 €	1.688 €	1.857 €	1.857 €	2.228 €
163↔167	162↔166	68	78	79	K2GFL163-			1.557 €	1.714 €	1.891 €	1.891 €	2.269 €
167↔171	166↔170	71	78	79	K2GFL167-			1.584 €	1.748 €	1.926 €	1.926 €	2.311 €
177↔181	176↔180	81	78	79	K2GFL177-			1.638 €	1.802 €	1.986 €	1.986 €	2.384 €

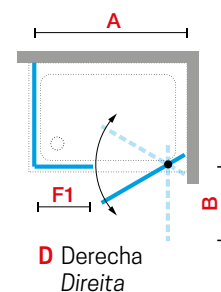
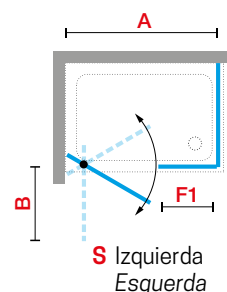
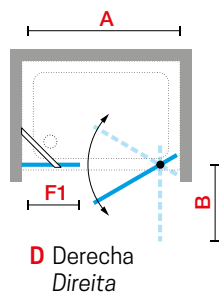
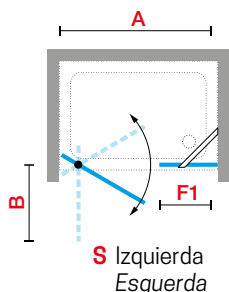
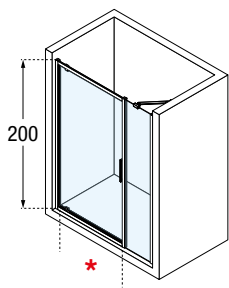

IMPORTANTE!
INDICAR EN PEDIDO
SI EL PLATO ES
SOBRELEVADO O A
RAS DE SUELO

INDICAR NA
ENCOMENDA SE
A BASE E SOBRE
ELEVADO O A NIVEL
DO CHÃO

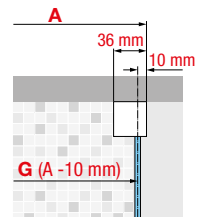



CRISTAL TEMPLADO / VIDRO TEMPERADO



Transparente
cod 1



Ser. Rose 1
cod 56

COLORES PERFILES / CORES PERFÍS



Blanco Mate
Branco Mate
cod. U

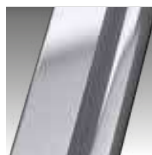

Silver
Abrillantado
cod. B



Cromo
cod. K



Negro mate
cod. H



Inox satinado
cod Z

KUADRA 2.0 AH



FRONTAL DE DOS HOJAS CORREDERAS + DOS FIJOS
RESGUARDO DE DUAS FOLHAS DE CORRER + DOS FIXOS

Medidas				Código	Derecha Direita	Izquierda Esquerda	Selección Cristales Seleção Vidros		Selección de perfiles Seleção de perfis				
Medidas extensibilidad Medidas extensibilidade	Medidas extensibilidad para platos a ras de suelo	Fijo frontal Fixo frontal	Entrada		D-	S-	1	56	U	B	K	H	Z
A	G	F1	*				Transparente	Ser. Rose 1	Blanco mate Branco mate	Silver Abrillantado	Cromo	Negro mate	Inox satinado
67↔69	66↔68	31,5	36	K2AH67L	D-	S-			628 €	689 €	760 €	760 €	912 €
69↔71	68↔70	33,5	37,5	K2AH69L	D-	S-			628 €	689 €	760 €	760 €	912 €
72↔74	71↔73	34,5	40	K2AH72L	D-	S-			640 €	710 €	788 €	788 €	944 €
74↔76	73↔75	36	41,5	K2AH74L	D-	S-			640 €	710 €	788 €	788 €	944 €
77↔79	76↔78	36,5	44	K2AH77L	D-	S-			668 €	739 €	815 €	815 €	978 €
79↔81	78↔80	38,5	45,5	K2AH79L	D-	S-			668 €	739 €	815 €	815 €	978 €
87↔89	86↔88	41,5	50	K2AH87L	D-	S-			696 €	766 €	843 €	843 €	1.011 €
89↔91	88↔90	43,5	51,5	K2AH89L	D-	S-			696 €	766 €	843 €	843 €	1.011 €
97↔99	96↔98	46,5	57	K2AH97L	D-	S-			731 €	808 €	890 €	890 €	1.068 €
99↔101	98↔100	48,5	58,5	K2AH99L	D-	S-			731 €	808 €	890 €	890 €	1.068 €
107↔109	106↔108	51,5	64	K2AH107L	D-	S-			766 €	843 €	933 €	933 €	1.119 €
109↔111	108↔110	53,5	65,5	K2AH109L	D-	S-			794 €	878 €	968 €	968 €	1.161 €
117↔119	116↔118	56,6	71	K2AH117L	D-	S-			822 €	905 €	995 €	995 €	1.195 €
119↔121	118↔120	58,5	72,5	K2AH119L	D-	S-			822 €	905 €	995 €	995 €	1.195 €

PARA COMPONER UN ÁNGULO PEDIR 2 LATERALES
FORMAR UM ÂNGULO PEDINDO DOIS LATERAIS

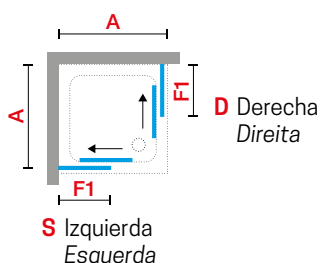
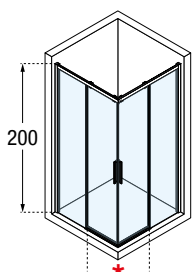

¡IMPORTANTE!
INDICAR EN PEDIDO SI EL PLATO ES SOBREELEVADO O A RAS DE SUELO
INDICAR NA ENCOMENDA SE A BASE E SOBRE ELEVADO O A NIVEL DO CHÃO

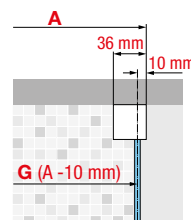



CRISTAL TEMPLADO / VIDRO TEMPERADO



Transparente
cod 1



Ser. Rose 1
cod 56

COLORES PERFILES / CORES PERFÍS



Blanco Mate
Branco Mate
cod. U

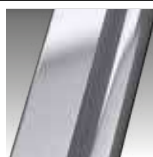

Silver
Abrillantado
cod. B



Cromo
cod. K



Negro mate
cod. H



Inox satinado
cod Z

KUADRA 2.0 G



MAMPARA DE DUCHA ABATIBLE DE UNA HOJA Para instalar entre paredes o con fijo lateral KUADRA 2.0 F

RESGUARDO DE DUCHE DE ABRIR DE UMA FOLHA Para instalar entre paredes ou com fixo lateral KUADRA 2.0 F

Medidas			Código	Selección Cristales Seleção Vidros		Selección de perfiles Seleção de perfis				
Medidas extensibilidad Medidas extensibilidade	Entrada	Espacio de apertura Espaço de abertura		1	56	U	B	K	H	Z
A	*	B		Transparente	Ser. Rose 1	Blanco mate Branco mate	Silver Abrilantado	Cromo	Negro mate	Inox satinado
67↔71	51	52	K2G67-			882 €	970 €	1.073 €	1.073 €	1.287 €
72↔76	56	57	K2G72-			888 €	977 €	1.079 €	1.079 €	1.294 €
77↔81	61	62	K2G77-		+ 40 €	895 €	990 €	1.092 €	1.092 €	1.310 €
87↔91	68	69	K2G87-			908 €	1.005 €	1.107 €	1.107 €	1.328 €
97↔101	78	79	K2G97-			922 €	1.018 €	1.120 €	1.120 €	1.344 €

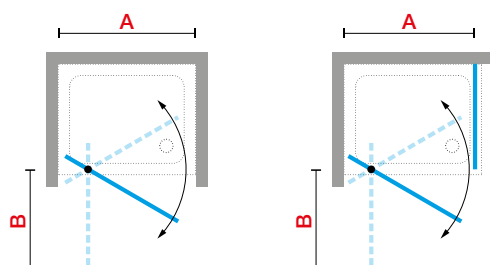
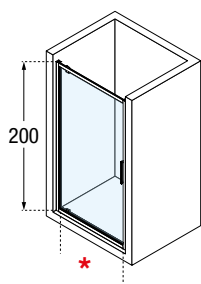



CRISTAL TEMPLADO / VIDRO TEMPERADO



Transparente
cod 1



Ser. Rose 1
cod 56

COLORES PERFILES / CORES PERFÍS



Blanco Mate
Branco Mate
cod. U

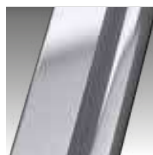

Silver
Abrillantado
cod. B



Cromo
cod. K



Negro mate
cod. H



Inox satinado
cod Z

KUADRA 2.0 F



PANEL FIJO
PAINEL FIXO

Medidas		Código	Selección Cristales Seleção Vidros		Selección de perfiles Seleção de perfis				
Medidas extensibilidad Medidas extensibilidade	Medidas extensibilidad para platos a ras de suelo		1	56	U	B	K	H	Z
A	G		Transparente	Ser. Rose 1	Blanco mate Branco mate	Silver Abrilantado	Cromo	Negro mate	Inox satinado
67↔69	66↔68	K2F67-			459 €	507 €	561 €	561 €	673 €
69↔71	68↔70	K2F69-			459 €	507 €	561 €	561 €	673 €
71↔73	70↔72	K2F71-			459 €	507 €	561 €	561 €	673 €
72↔74	71↔73	K2F72-			485 €	540 €	596 €	596 €	714 €
74↔76	73↔75	K2F74-			485 €	540 €	596 €	596 €	714 €
76↔78	75↔77	K2F76-			485 €	540 €	596 €	596 €	714 €
77↔79	76↔78	K2F77-			513 €	567 €	629 €	629 €	754 €
79↔81	78↔80	K2F79-			513 €	567 €	629 €	629 €	754 €
81↔83	80↔82	K2F81-			513 €	567 €	629 €	629 €	754 €
85↔87	84↔86	K2F85-			540 €	596 €	656 €	656 €	788 €
87↔89	86↔88	K2F87-			540 €	596 €	656 €	656 €	788 €
89↔91	88↔90	K2F89-			540 €	596 €	656 €	656 €	788 €
91↔93	90↔92	K2F91-		+ 40 €	567 €	629 €	697 €	697 €	836 €
95↔97	94↔96	K2F95-			567 €	629 €	697 €	697 €	836 €
97↔99	96↔98	K2F97-			567 €	629 €	697 €	697 €	836 €
99↔101	98↔100	K2F99-			596 €	656 €	724 €	724 €	868 €
101↔103	100↔102	K2F101-			596 €	656 €	724 €	724 €	868 €
105↔107	104↔106	K2F105-			596 €	656 €	724 €	724 €	868 €
107↔109	106↔108	K2F107-			622 €	691 €	765 €	765 €	918 €
109↔111	108↔110	K2F109-			622 €	691 €	765 €	765 €	918 €
111↔113	110↔112	K2F111-			622 €	691 €	765 €	765 €	918 €
115↔117	114↔116	K2F115-			635 €	704 €	779 €	779 €	935 €
117↔119	116↔118	K2F117-			635 €	704 €	779 €	779 €	935 €
119↔121	118↔120	K2F119-			663 €	731 €	806 €	806 €	967 €
121↔123	120↔122	K2F121-			663 €	731 €	806 €	806 €	967 €
H 140↔220 L 20↔121 SPECIAL		K2FSP		-	795 €	882 €	968 €	968 €	1.161 €

PARA MEDIDAS Y RECORTES ESPECIALES, POR FAVOR CONSULTA A TU DELEGADO O AL SERVICIO DE ATENCIÓN COMERCIAL

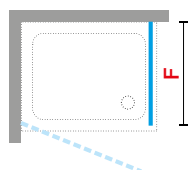
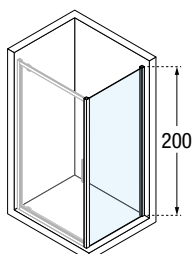

¡IMPORTANTE!
INDICAR EN PEDIDO
SI EL PLATO ES
SOBREELEVADO O A
RAS DE SUELO
INDICAR NA
ENCOMENDA SE
A BASE E SOBRE
ELEVADO O A NIVEL
DO CHÃO

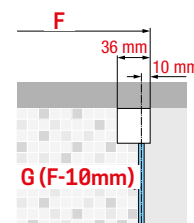



CRISTAL TEMPLADO / VIDRO TEMPERADO



Transparente
cod. 1



Ser. Rose 1
cod. 56

COLORES PERFILES / CORES PERFÍS



Blanco Mate
Branco Mate
cod. U

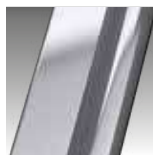

Silver
Abrillantado
cod. B



Cromo
cod. K



Negro mate
cod. H



Inox satinado
cod. Z

KUADRA 2.0 2B



200 cm



6 mm



4 cm



MAMPARA DE DOS HOJAS ABATIBLES Para instalar entre paredes o con fijo lateral KUADRA 2.0 F
RESGUARDO DE DUAS FOLHAS ABATÍVEIS Para instalar entre paredes ou com fixo lateral KUADRA 2.0 F



CRISTAL TEMPLADO VIDRO TEMPERADO



Transparente
cod 1



Ser. Rose 1
cod 56

COLORES PERFILES CORES PERFÍS



Blanco
Branco Mate
cod U



Silver
Abrillantado
cod B



Cromo
cod K



Negro mate
cod H



Inox satinado
cod Z

Medidas			Código	Selección Cristales Seleção Vidros		Selección de perfiles Seleção de perfis				
Medidas extensibilidad Medidas extensibilidade	Entrada	Espacio de apertura Espaço de abertura		1	56	U	B	K	H	Z
A	*	B		Transparente	Ser. Rose 1	Blanco mate Branco mate	Silver Abrillantado	Cromo	Negro mate	Inox satinado
67↔71	49	25	K22B67-			942 €	1.038 €	1.148 €	1.148 €	1.377 €
72↔76	54	28	K22B72-			977 €	1.079 €	1.189 €	1.189 €	1.427 €
77↔81	59	30	K22B77-		+ 40 €	1.011 €	1.113 €	1.229 €	1.229 €	1.474 €
87↔91	63	32	K22B87-			1.044 €	1.154 €	1.270 €	1.270 €	1.523 €
97↔101	73	37	K22B97-			1.079 €	1.189 €	1.311 €	1.311 €	1.428 €

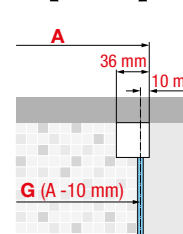
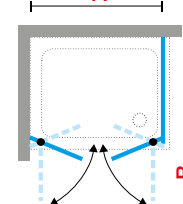
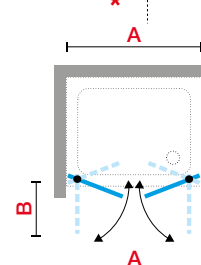
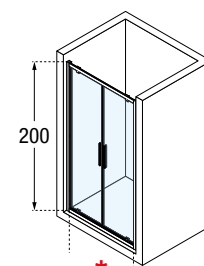

IMPORTANT!
INDICAR EN PEDIDO
SI EL PLATO ES
SOBREELEVADO O A
RAS DE SUELO
INDICAR NA
ENCOMENDA SE
A BASE E SOBRE
ELEVADO O A NIVEL
DO CHÃO

DATOS TÉCNICOS / DADOS TÉCNICOS

COLORES PERFILES / CORES PERFÍS



Blanco mate
Branco mate
cod. U

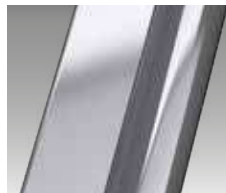

Silver/ Abrillantado
cod. B



Cromo
cod. K



Negro mate
cod. H



Inox satinado
cod. Z

CRISTAL TEMPLADO / VIDRO TEMPERADO 8 mm (Según norma Europea UNE EN 14428)



Transparente
cod. 1



SERIGRAFIA



Ser. Rose 1
cod. 56

TIRADOR / PUXADOR



Tirador Metálico /
Puxador de metal

MEDIDAS QUE OCUPAN LOS PERFILES EN LA PARED / ESPAÇO QUE OCUPAN OS PERFÍS NA PAREDE

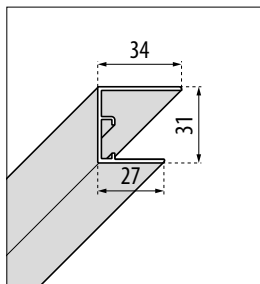

A PARED
para todos los modelos

Altura	Color perfil Cor perfil	Código
2000	Blanco / Branco	P01BWMOST-U
	Silver / Abrillantado	P01BWMOST-B
	Cromo	P01BWMOST-H
	Negro mate	P01BWMOST-K
	Inox satinado	P01BWMOST-Z

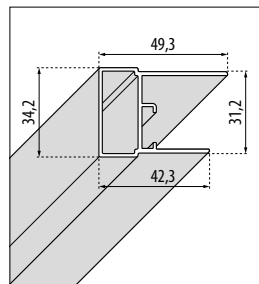

A PARED
para todos los modelos

Altura	Color perfil Cor perfil	Código
2000	Blanco / Branco	P05BWMOST-U
	Silver / Abrillantado	P05BWMOST-B
	Cromo	P05BWMOST-H
	Negro mate	P05BWMOST-K
	Inox satinado	P05BWMOST-Z

TOMA DE MEDIDAS

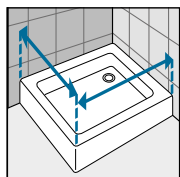

Tomar las medidas desde la pared hasta el borde externo del plato de ducha.
Medir a distância desde a parede até o rebordo externo da base de chuveiro.

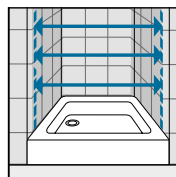

Tomar medidas de pared a pared, medir la parte baja, la central y la superior. Cursar el pedido con la medida más pequeña.
Medir a distância entre paredes, tem que tirar três medidas (inferior, superior e central) e utilizar a inferior. Encomendar pedido da medida mais pequena.

ROSE

SOLUCIONES PARA
GRANDES ESPACIOS
Y GRAN VERSATILIDAD.

SOLUÇÕES PARA GRANDES
ESPAÇOS E GRANDE
VERSATILIDADE.



◀ Tirador de cristal
Puxador em cristal



◀ Técnica y funcional
Tecnica e funcional



◀ ROSE EVO
Nuevo sistema de liberación
de puertas para una fácil
limpieza.
Para modelos A-2P-PH-2A
*Novo sistema de liberação
das portas para uma fácil
limpeza.
Para modelos A-2P-PH-2A*



TRATAMIENTOS / TRATAMENTOS





ROSE

ROSE PH+FH



MAMPARA DE 2 HOJAS: 1 CORREDERA + 1 FIJA + PANEL FIJO LATERAL SIN PERFIL ANGULAR
RESGUARDO DE 2 FOLHAS: 1 DE CORRER + 1 FIXA + PAINEL FIXO LATERAL

Medidas					Código	Derecha Direita	Izquierda Esquerda	Selección Cristales Seleção Vidros				Selección de perfiles Seleção de perfis		
Medidas extensibilidad Medidas extensibilidade con fijo com fijo	Medidas extensibilidad para platos a ras de suelo	entre paredes entre paredes	Fijo frontal Fijo frontal	Entrada		D-	S-	1	4	56	57	D	B	K
A	G	A1	F1	*				Transpa- rente	Satinado Fosco	Ser. Rose 1	Ser. Rose 2	Blanco Branco	Silver Abrillantado	Cromo
PUERTA / PORTA														
117↔120	115,6↔118,6	115↔118	62	47	ROSEPH117	D-	S-					813 €	895 €	985 €
120↔123	118,6↔121,6	118↔121	65	47	ROSEPH120	D-	S-					813 €	895 €	985 €
123↔126	121,6↔124,6	121↔124	68	47	ROSEPH123	D-	S-					813 €	895 €	985 €
126↔129	124,6↔127,6	124↔127	71	47	ROSEPH126	D-	S-					813 €	895 €	985 €
127↔130	125,6↔128,6	125↔128	67	52	ROSEPH127	D-	S-					813 €	895 €	985 €
129↔132	127,6↔130,6	127↔130	69	52	ROSEPH129	D-	S-					813 €	895 €	985 €
132↔135	130,6↔133,6	130↔133	72	52	ROSEPH132	D-	S-					813 €	895 €	985 €
135↔138	133,6↔136,6	133↔136	75	52	ROSEPH135	D-	S-					813 €	895 €	985 €
137↔140	135,6↔138,6	135↔138	72	57	ROSEPH137	D-	S-					901 €	991 €	1.092 €
138↔141	136,6↔139,6	136↔139	73	57	ROSEPH138	D-	S-					901 €	991 €	1.092 €
141↔144	139,6↔142,6	139↔142	76	57	ROSEPH141	D-	S-					901 €	991 €	1.092 €
144↔147	142,6↔145,6	142↔145	79	57	ROSEPH144	D-	S-					901 €	991 €	1.092 €
147↔150	145,6↔148,6	145↔148	77	62	ROSEPH147	D-	S-	+ 40 €	+ 40 €	+ 40 €		901 €	991 €	1.092 €
150↔153	148,6↔151,6	148↔151	80	62	ROSEPH150	D-	S-					901 €	991 €	1.092 €
153↔156	151,6↔154,6	151↔154	83	62	ROSEPH153	D-	S-					901 €	991 €	1.092 €
156↔159	154,6↔157,6	154↔157	86	62	ROSEPH156	D-	S-					901 €	991 €	1.092 €
157↔160	155,6↔158,6	155↔158	82	67	ROSEPH157	D-	S-					947 €	1.041 €	1.147 €
159↔162	157,6↔160,6	157↔160	84	67	ROSEPH159	D-	S-					947 €	1.041 €	1.147 €
162↔165	160,6↔163,6	160↔163	87	67	ROSEPH162	D-	S-					947 €	1.041 €	1.147 €
165↔168	163,6↔166,6	163↔166	90	67	ROSEPH165	D-	S-					947 €	1.041 €	1.147 €
167↔170	165,6↔168,6	165↔168	92	67	ROSEPH167	D-	S-					947 €	1.041 €	1.147 €
171↔174	169,6↔172,6	169↔172	96	67	ROSEPH171	D-	S-					991 €	1.092 €	1.202 €
174↔177	172,6↔175,6	172↔175	99	67	ROSEPH174	D-	S-					991 €	1.092 €	1.202 €
177↔180	175,6↔178,6	175↔178	102	67	ROSEPH177	D-	S-					991 €	1.092 €	1.202 €

OPCIONAL - KIT DE CIERRE CON PERFIL MAGNETICO PARA VERSION ENTRE PAREDES:														
F	G	A1	F1	*	Código	D-	S-	1	4	56	57	D	B	K
								Transpa- rente	Satinado Fosco	Ser. Rose 1	Ser. Rose 2	Blanco Branco	Silver Abrillantado	Cromo
					KROSPHPN-			-	-	-	-	94 €	101 €	108 €

PANEL FIJO LATERAL SIN PERFIL ANGULAR REVERSIBLE / PAINEL FIXO LATERAL SEM PERFIL ANGULAR REVERSÍVEL														
F	G	A1	F1	*	Código	D-	S-	1	4	56	57	D	B	K
								Transpa- rente	Satinado Fosco	Ser. Rose 1	Ser. Rose 2	Blanco Branco	Silver Abrillantado	Cromo
68↔71	66,6↔69,6	-	-	-	ROSEFH68-	-	-					317 €	348 €	381 €
71↔74	69,6↔72,6	-	-	-	ROSEFH71-	-	-					317 €	348 €	381 €
74↔77	72,6↔75,6	-	-	-	ROSEFH74-	-	-					333 €	363 €	396 €
76↔79	74,6↔77,6	-	-	-	ROSEFH76-	-	-					333 €	363 €	396 €
78↔81	76,6↔79,6	-	-	-	ROSEFH78-	-	-	+ 40 €				333 €	363 €	396 €
88↔91	86,6↔89,6	-	-	-	ROSEFH88-	-	-					348 €	381 €	417 €
98↔101	96,6↔99,6	-	-	-	ROSEFH98-	-	-					363 €	396 €	434 €
108↔111	106,6↔109,6	-	-	-	ROSEFH108-	-	-					379 €	416 €	453 €
118↔121	116,6↔119,6	-	-	-	ROSEFH118-	-	-					395 €	432 €	472 €

PANEL FIJO LATERAL SIN PERFIL ANGULAR SERIGRAFIA NO REVERSIBLE / PAINEL FIXO LATERAL SEM PERFIL ANGULAR SERIGRAFIADO NON REVERSÍVEL														
F	G	A1	F1	*	Código	D-	S-	1	4	56	57	D	B	K
								Transpa- rente	Satinado Fosco	Ser. Rose 1	Ser. Rose 2	Blanco Branco	Silver Abrillantado	Cromo
68↔71	66,6↔69,6	-	-	-	ROSEFH68	D-	S-					317 €	348 €	381 €
71↔74	69,6↔72,6	-	-	-	ROSEFH71	D-	S-					317 €	348 €	381 €
74↔77	72,6↔75,6	-	-	-	ROSEFH74	D-	S-					333 €	363 €	396 €
76↔79	74,6↔77,6	-	-	-	ROSEFH76	D-	S-					333 €	363 €	396 €
78↔81	76,6↔79,6	-	-	-	ROSEFH78	D-	S-			+ 40 €	+ 40 €	333 €	363 €	396 €
88↔91	86,6↔89,6	-	-	-	ROSEFH88	D-	S-					348 €	381 €	417 €
98↔101	96,6↔99,6	-	-	-	ROSEFH98	D-	S-					363 €	396 €	434 €
108↔111	106,6↔109,6	-	-	-	ROSEFH108	D-	S-					379 €	416 €	453 €
118↔121	116,6↔119,6	-	-	-	ROSEFH118	D-	S-					395 €	432 €	472 €

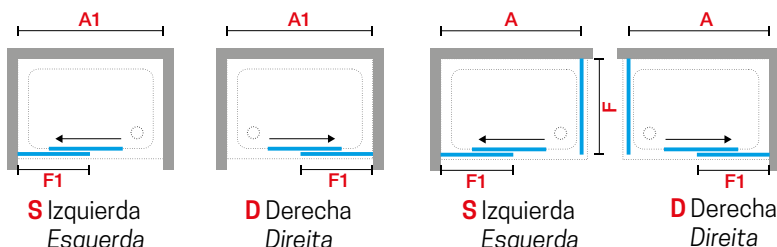
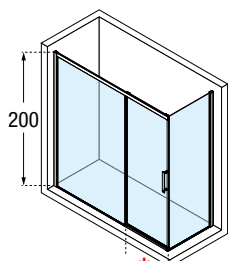

¡IMPORTANTE!
INDICAR EN PEDIDO
SI EL PLATO ES
SOBREELEVADO O A
RAS DE SUELO
INDICAR NA
ENCOMENDA SE A BASE
E SOBRE ELEVADO O A
NIVEL DO CHÃO

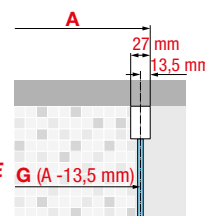



NUEVO SISTEMA DE SUJECIÓN
AL CRISTAL

CRISTAL TEMPLADO / VIDRO TEMPERADO



Transparente
cod 1



Satinado
Fosco
cod 4



Ser. Rose 1
cod 56



Ser. Rose 2
cod 57

COLORES PERFILES / CORES PERFÍS



Blanco
Branco
cod. D

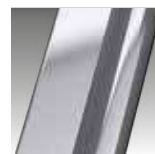

Silver
Abrillantado
cod. B



Cromo
cod. K

ROSE 2P



PUERTA DE DOS HOJAS: UNA CORREDERA + UNA FIJA /Para instalar entre paredes o con fijo lateral ROSE F

RESGUARDO DE DUAS FOLHIAS: UNA DE CORRER + UNA FIXA /Para instalar entre paredes ou com fixo lateral ROSE F

Medidas				Código	Derecha Direita	Izquierda Esquerda	Selección Cristales Seleção Vidros				Selección de perfiles Seleção de perfis		
Medidas extensibilidad Medidas extensibilidade	Medidas extensibilidad para platos a ras de suelo	Fijo frontal Fixo frontal	Entrada		D-	S-	1	4	56	57	D	B	K
A	G	F1	*				Transparente	Satinado Fosco	Ser. Rose 1	Ser. Rose 2	Blanco Branco	Silver Abrrilantado	Cromo
96↔102	94,6↔100,6	44	37,5	ROSE2P96	D-	S-					933 €	1.026 €	1.128 €
114↔120	112,6↔118,6	53	46	ROSE2P114	D-	S-					933 €	1.026 €	1.128 €
116↔122	114,6↔120,6	54	47	ROSE2P116	D-	S-					933 €	1.026 €	1.128 €
121↔127	119,6↔125,6	57	49,5	ROSE2P121	D-	S-					962 €	1.059 €	1.164 €
126↔132	124,6↔130,6	59	52	ROSE2P126	D-	S-					962 €	1.059 €	1.164 €
131↔137	129,6↔135,6	61	54,5	ROSE2P131	D-	S-					991 €	1.092 €	1.202 €
136↔142	134,6↔140,6	64	57	ROSE2P136	D-	S-					991 €	1.092 €	1.202 €
141↔147	139,6↔145,6	66	59,5	ROSE2P141	D-	S-					1.023 €	1.126 €	1.239 €
146↔152	144,6↔150,6	69	62	ROSE2P146	D-	S-					1.023 €	1.126 €	1.239 €
151↔157	149,6↔155,6	74	62	ROSE2P151	D-	S-		+ 40 €	+ 40 €	+ 40 €	1.053 €	1.158 €	1.272 €
156↔162	154,6↔160,6	79	62	ROSE2P156	D-	S-					1.053 €	1.158 €	1.272 €
161↔167	159,6↔165,6	84	62	ROSE2P161	D-	S-					1.081 €	1.191 €	1.311 €
166↔172	164,6↔170,6	89	62	ROSE2P166	D-	S-					1.081 €	1.191 €	1.311 €
171↔177	169,6↔175,6	94	62	ROSE2P171	D-	S-					1.112 €	1.223 €	1.346 €
176↔182	174,6↔180,6	99	62	ROSE2P176	D-	S-					1.112 €	1.223 €	1.346 €
181↔187	179,6↔185,6	104	62	ROSE2P181	D-	S-					1.143 €	1.256 €	1.382 €
186↔192	184,6↔190,6	109	62	ROSE2P186	D-	S-					1.143 €	1.256 €	1.382 €
191↔197	189,6↔195,6	114	62	ROSE2P191	D-	S-					1.158 €	1.272 €	1.399 €
196↔202	194,6↔200,6	119	62	ROSE2P196	D-	S-					1.158 €	1.272 €	1.399 €

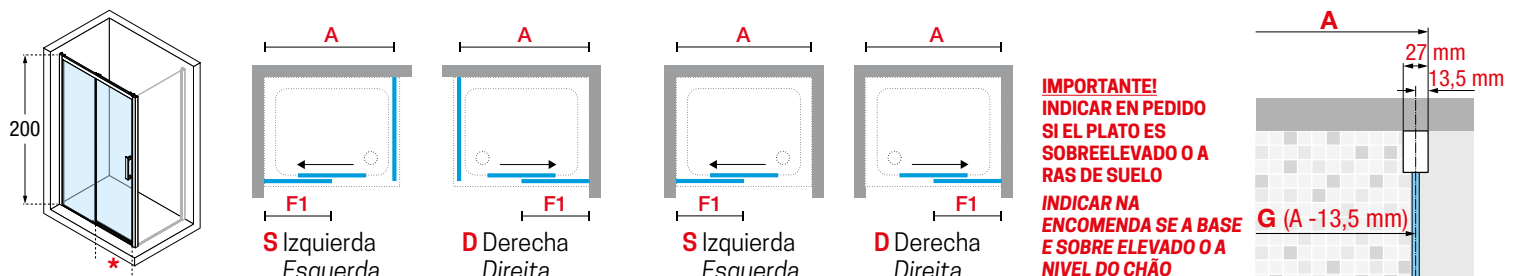

056 Construcción del código: **Código** + **Izquierda / Derecha** + **Cristales** + **Perfiles** = Código completo del producto
 Construção do código: **Código** + **Esquerda / Direita** + **Vidros** + **Perfis** = Código completo do produto

CRISTAL TEMPLADO / VIDRO TEMPERADO

Transparente
cod 1

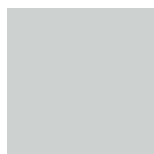

Satinado
Fosco
cod 4



Ser. Rose 1
cod 56



Ser. Rose 2
cod 57

COLORES PERFILES / CORES PERFÍS

Blanco
Branco
cod. D

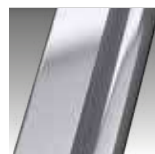

Silver
Abbrillatado
cod. B



Cromo
cod. K

ROSE PHB

MAMPARA DE 2 HOJAS: 1 CORREDERA + 1 FIJA + BARRA DE SUJECIÓN LATERAL
RESGUARDO DE 2 FOLHAS: 1 DE CORRER + 1 FIXA + BARRA DE FIXAÇÃO



200 cm



6 mm
puerta
porta



8 mm
fijo
fixo



3 cm



CRISTAL TEMPLADO VIDRO TEMPERADO



Transparente
cod 1



Satinado
Fosco
cod 4



Ser. Rose 1
cod 56



Ser. Rose 2
cod 57

COLORES PERFILES CORES PERFÍS



Blanco
Branco
cod. D



Silver
Abrillantado
cod. B



Cromo
cod K

Medidas		Código	Derecha Direita	Izquierda Esquerda	Selección Cristales Seleção Vidros				Selección de perfiles Seleção de perfis		
Medidas extensibilidad Medidas extensibilidade	Fijo frontal Fixo frontal		D-	S-	1	4	56	57	D	B	K
A	F1				Transparente	Satinado Fosco	Ser. Rose 1	Ser. Rose 2	Blanco Branco	Silver Abrillantado	Cromo
117↔120	63	ROSEPHB117	D-	S-					864 €	942 €	1.027 €
127↔130	68	ROSEPHB127	D-	S-					864 €	942 €	1.027 €
137↔140	73	ROSEPHB137	D-	S-					954 €	1.041 €	1.136 €
147↔150	78	ROSEPHB147	D-	S-	+ 40 €	+ 40 €	+ 40 €		954 €	1.041 €	1.136 €
157↔160	83	ROSEPHB157	D-	S-					999 €	1.089 €	1.189 €
167↔170	93	ROSEPHB167	D-	S-					999 €	1.089 €	1.189 €
177↔180	103	ROSEPHB177	D-	S-					1.043 €	1.140 €	1.242 €

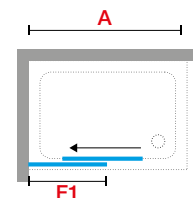
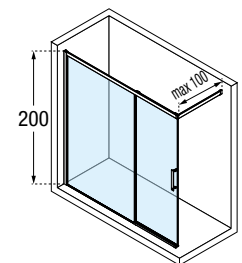

S Izquierda
Esquerda

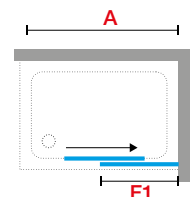

D Derecha
Direita

¡IMPORTANTE!
INDICAR EN PEDIDO SI EL PLATO ES SOBREELEVADO O A RAS DE SUELO
INDICAR NA ENCOMENDA SE A BASE E SOBRE ELEVADO O A NIVEL DO CHÃO

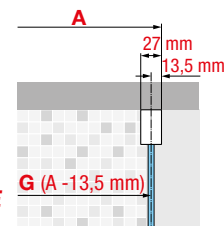

ROSE 2M



200 cm



6 mm



6 cm



MAMPARA DE DOS HOJAS CORREDERAS / Para instalar entre paredes o con fijo lateral ROSE F

RESGUARDO DE DUAS FOLHAS DE CORRER / Para instalar entre paredes ou com fixo lateral ROSE F



CRISTAL TEMPLADO VIDRO TEMPERADO



Transparente
cod 1



Satinado
Fosco
cod 4



Ser. Rose 1
cod 56



Ser. Rose 2
cod 57

COLORES PERFILES CORES PERFIS



Blanco
Branco
cod. D



Silver
Abrillantado
cod. B



Cromo
cod K

Medidas		Código	Selección Cristales Seleção Vidros				Selección de perfiles Seleção de perfis		
Medidas extensibilidad Medidas extensibilidade	Entrada		1	4	56	57	D	B	K
A	*		Transparente	Satinado Fosco	Ser. Rose 1	Ser. Rose 2	Blanco Branco	Silver Brillantado	Cromo
116↔122	43	ROSE2M116-					991 €	1.092 €	1.202 €
126↔132	48	ROSE2M126-					991 €	1.092 €	1.202 €
136↔142	53	ROSE2M136-					1.053 €	1.158 €	1.272 €
146↔152	58	ROSE2M146-		+ 40 €	+ 40 €	+ 40 €	1.053 €	1.158 €	1.272 €
156↔162	63	ROSE2M156-					1.112 €	1.223 €	1.346 €
166↔172	68	ROSE2M166-					1.112 €	1.223 €	1.346 €
176↔182	73	ROSE2M176-					1.173 €	1.290 €	1.420 €

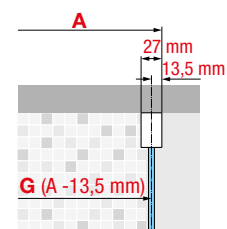
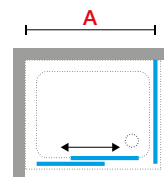
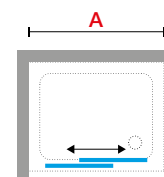
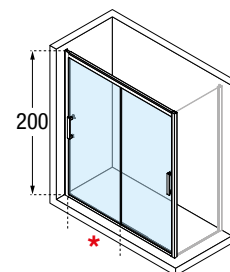

¡IMPORTANTE!
INDICAR EN PEDIDO SI EL PLATO ES SOBREELEVADO O A RAS DE SUELO
INDICAR NA ENCOMENDA SE A BASE E SOBRE ELEVADO O A NIVEL DO CHÃO

Construcción del código:
Construção do código

Código

+

Cristales
Vidros

+

Perfiles
Perfis

=

Código completo del producto
Código completo do produto

ROSE 3PH+FH



MAMPARA DE TRES HOJAS, 2 CORREDERAS + 1 FIJA
RESGUARDO DE TRES FOLHAS, 2 CORRER + 1 FIXA

Medidas				Código	Derecha Direita	Izquierda Esquerda	Selección Cristales Seleção Vidros				Selección de perfiles Seleção de perfis		
Medidas extensibilidad Medidas extensibilidade	Medidas extensibilidad para platos a ras de suelo	Entre paredes	Entrada		D-	S-	1	4	56	57	D	B	K
A	G	B	*				Transparente	Satinado Fosco	Ser. Rose 1	Ser. Rose 2	Blanco Branco	Silver Abrillantado	Cromo
80-83	78,6↔81,6	78↔81	41	ROSE3PH78	D-	S-					819 €	901 €	996 €
83-86	81,6↔84,6	81↔84	43	ROSE3PH81	D-	S-					819 €	901 €	996 €
86-89	84,6↔87,6	84↔87	45	ROSE3PH84	D-	S-					868 €	956 €	1.053 €
89-92	87,6↔90,6	87↔90	47	ROSE3PH87	D-	S-					868 €	956 €	1.053 €
92-95	90,6↔93,6	90↔93	49	ROSE3PH90	D-	S-					868 €	956 €	1.053 €
95-98	93,6↔96,6	93↔96	51	ROSE3PH93	D-	S-					895 €	990 €	1.092 €
98-101	96,6↔99,6	96↔99	53	ROSE3PH96	D-	S-					895 €	990 €	1.092 €
101-104	99,6↔102,6	99↔102	55	ROSE3PH99	D-	S-					895 €	990 €	1.092 €
104-107	102,6↔105,6	102↔105	57	ROSE3PH102	D-	S-					936 €	1.031 €	1.133 €
107-110	105,6↔108,6	105↔108	59	ROSE3PH105	D-	S-					936 €	1.031 €	1.133 €
110-113	108,6↔111,6	108↔111	61	ROSE3PH108	D-	S-					936 €	1.031 €	1.133 €
113-116	111,6↔114,6	111↔114	63	ROSE3PH111	D-	S-	+ 40 €	+ 40 €	+ 40 €		964 €	1.065 €	1.174 €
116-119	114,6↔117,6	114↔117	65	ROSE3PH114	D-	S-					964 €	1.065 €	1.174 €
119-122	117,6↔120,6	117↔120	67	ROSE3PH117	D-	S-					1.005 €	1.107 €	1.222 €
122-125	120,6↔123,6	120↔123	69	ROSE3PH120	D-	S-					1.005 €	1.107 €	1.222 €
125-128	123,6↔126,6	123↔126	71	ROSE3PH123	D-	S-					1.005 €	1.107 €	1.222 €
128-131	126,6↔129,6	126↔129	73	ROSE3PH126	D-	S-					1.044 €	1.154 €	1.270 €
129-132	127,6↔130,6	127↔130	74	ROSE3PH127	D-	S-					1.044 €	1.154 €	1.270 €
131-134	129,6↔132,6	129↔132	75	ROSE3PH129	D-	S-					1.044 €	1.154 €	1.270 €
134-137	132,6↔135,6	132↔135	77	ROSE3PH132	D-	S-					1.079 €	1.189 €	1.311 €
137-140	135,6↔138,6	135↔138	79	ROSE3PH135	D-	S-					1.079 €	1.189 €	1.311 €
139-142	137,6↔140,6	137↔140	81	ROSE3PH137	D-	S-					1.120 €	1.237 €	1.359 €
140-143	138,6↔141,6	138↔141	81	ROSE3PH138	D-	S-					1.120 €	1.237 €	1.359 €
					D-	S-	1	4	56	57	D	B	K

Medidas				Código	Derecha Direita	Izquierda Esquerda	Selección Cristales Seleção Vidros				Selección de perfiles Seleção de perfis		
Medidas extensibilidad Medidas extensibilidade	Medidas extensibilidad para platos a ras de suelo	Entre paredes	Entrada		D-	S-	1	4	56	57	D	B	K
F							Transparente	Satinado Fosco	Ser. Rose 1	Ser. Rose 2	Blanco Branco	Silver Abrillantado	Cromo
PANEL FIJO LATERAL SIN PERFIL ANGULAR REVERSIBLE / PAINEL FIXO LATERAL SEM PERFIL ANGULAR REVERSÍVEL													
68↔71	66,6↔69,6	-	-	ROSEFH68-	-	-					317 €	348 €	381 €
71↔74	69,6↔72,6	-	-	ROSEFH71-	-	-					317 €	348 €	381 €
74↔77	72,6↔75,6	-	-	ROSEFH74-	-	-					333 €	363 €	396 €
76↔79	74,6↔77,6	-	-	ROSEFH76-	-	-					333 €	363 €	396 €
78↔81	76,6↔79,6	-	-	ROSEFH78-	-	-	+ 40 €	-	-		333 €	363 €	396 €
88↔91	86,6↔89,6	-	-	ROSEFH88-	-	-					348 €	381 €	417 €
98↔101	96,6↔99,6	-	-	ROSEFH98-	-	-					363 €	396 €	434 €
108↔111	106,6↔109,6	-	-	ROSEFH108-	-	-					379 €	416 €	453 €
118↔121	116,6↔119,6	-	-	ROSEFH118-	-	-					395 €	432 €	472 €

Medidas				Código	Derecha Direita	Izquierda Esquerda	Selección Cristales Seleção Vidros				Selección de perfiles Seleção de perfis		
Medidas extensibilidad Medidas extensibilidade	Medidas extensibilidad para platos a ras de suelo	Entre paredes	Entrada		D-	S-	1	4	56	57	D	B	K
F							Transparente	Satinado Fosco	Ser. Rose 1	Ser. Rose 2	Blanco Branco	Silver Abrillantado	Cromo
PANEL FIJO LATERAL SIN PERFIL ANGULAR SERIGRAFIA NO REVERSIBLE / PAINEL FIXO LATERAL SEM PERFIL ANGULAR SERIGRAFIADO NON REVERSÍVEL													
68↔71	66,6↔69,6	-	-	ROSEFH68	D-	S-					317 €	348 €	381 €
71↔74	69,6↔72,6	-	-	ROSEFH71	D-	S-					317 €	348 €	381 €
74↔77	72,6↔75,6	-	-	ROSEFH74	D-	S-					333 €	363 €	396 €
76↔79	74,6↔77,6	-	-	ROSEFH76	D-	S-					333 €	363 €	396 €
78↔81	76,6↔79,6	-	-	ROSEFH78	D-	S-	-	-	+ 40 €	+ 40 €	333 €	363 €	396 €
88↔91	86,6↔89,6	-	-	ROSEFH88	D-	S-					348 €	381 €	417 €
98↔101	96,6↔99,6	-	-	ROSEFH98	D-	S-					363 €	396 €	434 €
108↔111	106,6↔109,6	-	-	ROSEFH108	D-	S-					379 €	416 €	453 €
118↔121	116,6↔119,6	-	-	ROSEFH118	D-	S-					395 €	432 €	472 €

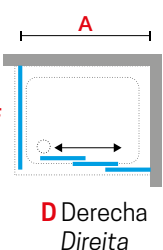
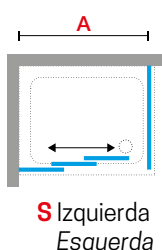
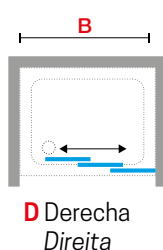
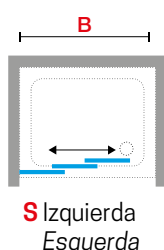
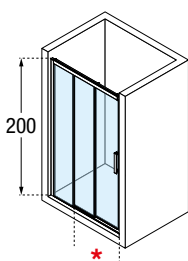

¡IMPORTANTE!
INDICAR EN PEDIDO
SI EL PLATO ES
SOBREELEVADO O A
RAS DE SUELO
INDICAR NA
ENCOMENDA SE A BASE
E SOBRE ELEVADO O A
NIVEL DO CHÃO

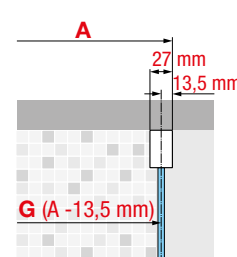



CRISTAL TEMPLADO / VIDRO TEMPERADO



Transparente
cod 1



Satinado
Fosco
cod 4



Ser. Rose 1
cod 56



Ser. Rose 2
cod 57

COLORES PERFILES / CORES PERFÍS



Blanco
Branco
cod. D

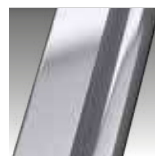

Silver
Abbrillatado
cod. B



Cromo
cod. K

ROSE A



MAMPARA ANGULAR DE DOS PUERTAS CORREDERAS + DOS FIJOS RESGUARDO ANGULAR DE DUAS PORTS DE CORRER + DOS FIXOS

Medidas				Código	Derecha Direita	Izquierda Esquerda	Selección Cristales Seleção Vidros				Selección de perfiles Seleção de perfis		
Medidas extensibilidad Medidas extensibilidade	Medidas extensibilidad para platos a ras de suelo	Fijo frontal Fixo frontal	Entrada		D-	S-	1	4	56	57	D	B	K
A	G	F1	*				Transparente	Satinado Fosco	Ser. Rose 1	Ser. Rose 2	Blanco Branco	Silver Abrrillantado	Cromo
67↔70	65,6↔68,6	30	34	ROSEA68L	D-	S-					543 €	591 €	646 €
70↔73	68,6↔71,6	31	36	ROSEA71L	D-	S-					543 €	591 €	646 €
72↔75	70,6↔73,6	32	37,5	ROSEA73L	D-	S-					559 €	610 €	665 €
74↔77	72,6↔75,6	33	39	ROSEA75L	D-	S-					559 €	610 €	665 €
77↔80	75,6↔78,6	35	41	ROSEA78L	D-	S-					572 €	624 €	681 €
80↔83	78,6↔81,6	36	43	ROSEA81L	D-	S-					572 €	624 €	681 €
82↔85	80,6↔83,6	37	44,5	ROSEA83L	D-	S-					572 €	624 €	681 €
84↔87	82,6↔85,6	38	46	ROSEA85L	D-	S-					572 €	624 €	681 €
87↔90	85,6↔88,6	40	48	ROSEA88L	D-	S-					587 €	641 €	700 €
90↔93	88,6↔91,6	41	50	ROSEA91L	D-	S-					587 €	641 €	700 €
92↔95	90,6↔93,6	42	51,5	ROSEA93L	D-	S-					602 €	657 €	716 €
94↔97	92,6↔95,6	43	53	ROSEA95L	D-	S-		+ 40 €	+ 40 €	+ 40 €	602 €	657 €	716 €
97↔100	95,6↔98,6	45	55	ROSEA98L	D-	S-					618 €	673 €	736 €
100↔103	98,6↔101,6	46	57	ROSEA101L	D-	S-					618 €	673 €	736 €
102↔105	100,6↔103,6	48	57	ROSEA103L	D-	S-					631 €	691 €	752 €
104↔107	102,6↔105,6	50	57	ROSEA105L	D-	S-					631 €	691 €	752 €
107↔110	105,6↔108,6	53	57	ROSEA108L	D-	S-					647 €	707 €	771 €
110↔113	108,6↔111,6	56	57	ROSEA111L	D-	S-					647 €	707 €	771 €
112↔115	110,6↔113,6	58	57	ROSEA113L	D-	S-					663 €	723 €	789 €
114↔117	112,6↔115,6	60	57	ROSEA115L	D-	S-					663 €	723 €	789 €
117↔120	115,6↔118,6	63	57	ROSEA118L	D-	S-					676 €	740 €	805 €
127↔130	125,6↔128,6	73	57	ROSEA128L	D-	S-					708 €	772 €	842 €
137↔140	135,6↔138,6	83	57	ROSEA138L	D-	S-					739 €	803 €	878 €

PARA COMPONER UN ÁNGULO PEDIR 2 LATERALES FORMAR UM ÂNGULO PEDINDO DOIS LATERAIS

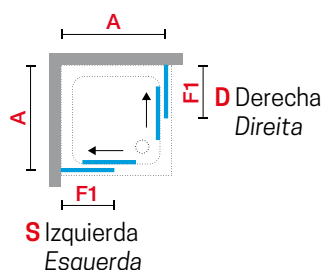
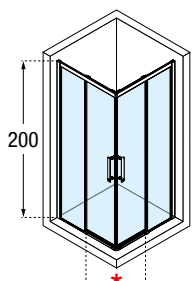

¡IMPORTANTE!
INDICAR EN PEDIDO SI EL PLATO ES SOBREELEVADO O A RAS DE SUELO
INDICAR NA ENCOMENDA SE A BASE E SOBRE ELEVADO O A NIVEL DO CHÃO

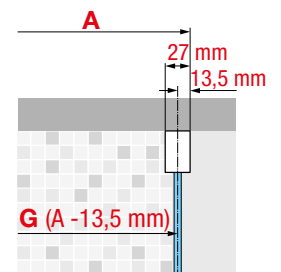



CRISTAL TEMPLADO / VIDRO TEMPERADO



Transparente
cod 1



Satinado
Fosco
cod 4



Ser. Rose 1
cod 56



Ser. Rose 2
cod 57

COLORES PERFILES / CORES PERFÍS



Blanco
Branco
cod. D

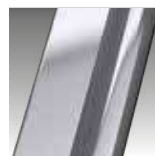

Silver
Abbrillatado
cod. B



Cromo
cod. K

ROSE 3P



200 cm



6 mm



6 cm



MAMPARA DE TRES HOJAS CORREDERAS / Para instalar entre paredes o con fijo lateral ROSE F
RESGUARDO DE TRES FOLHAS DE CORRER / Para instalar entre paredes ou com fixo lateral ROSE F



CRISTAL TEMPLADO VIDRO TEMPERADO



Transparente
cod 1

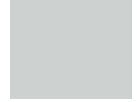

Satinado
Fosco
cod 4



Ser. Rose 1
cod 56



Ser. Rose 2
cod 57

COLORES PERFILES CORES PERFÍS



Blanco
Branco
cod. D



Silver
Abrillantado
cod. B



Cromo
cod K

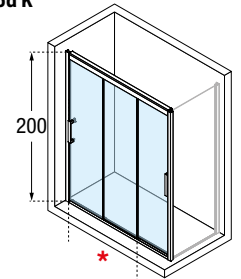

Medidas		Código	Selección Cristales Seleção Vidros				Selección de perfiles Seleção de perfis		
Medidas extensibilidad Medidas extensibilidade	Entrada		1	4	56	57	D	B	K
A	*		Transparente	Satinado Fosco	Ser. Rose 1	Ser. Rose 2	Blanco Branco	Silver Brillantado	Cromo
76↔82	36	ROSE3P76-					858 €	943 €	1.038 €
86↔92	34	ROSE3P86-					887 €	977 €	1.074 €
96↔102	40	ROSE3P96-					933 €	1.026 €	1.128 €
106↔112	47	ROSE3P106-					978 €	1.076 €	1.186 €
116↔122	54	ROSE3P116-					1.023 €	1.126 €	1.239 €
126↔132	60	ROSE3P126-		+ 40 €	+ 40 €	+ 40 €	1.067 €	1.174 €	1.291 €
136↔142	67	ROSE3P136-					1.112 €	1.223 €	1.346 €
146↔152	73	ROSE3P146-					1.143 €	1.256 €	1.382 €
156↔162	80	ROSE3P156-					1.187 €	1.306 €	1.436 €
166↔172	86	ROSE3P166-					1.233 €	1.356 €	1.491 €
176↔182	93	ROSE3P176-					1.277 €	1.405 €	1.547 €

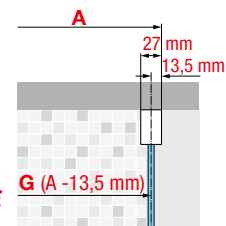
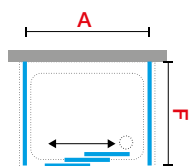
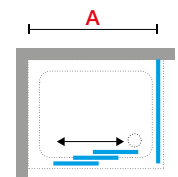
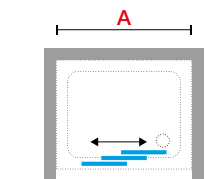

¡IMPORTANTE!
INDICAR EN PEDIDO SI EL PLATO ES SOBREELEVADO O A RAS DE SUELO
INDICAR NA ENCOMENDA SE A BASE E SOBRE ELEVADO O A NIVEL DO CHÃO



200 cm



6 mm



3 cm



MAMPARA SEMICIRCULAR DE DOS PUERTAS CORREDERAS + DOS FIJOS
RESGUARDO PARA BASE SEMICIRCULAR COMPUESTO POR DUAS PORTAS DE CORRER



CRISTAL TEMPLADO
VIDRO TEMPERADO



Transparente
cod 1



Satinado
 Fosco
cod 4



Ser. Rose 1
cod 56



Ser. Rose 2
cod 57

COLORES PERFILES
CORES PERFIS



Blanco
 Branco
cod. D



Silver
 Abrrillantado
cod. B



Cromo
cod K

Medidas					Código	Derecha Direita	Izquierda Esquerda	Selección Cristales Seleção Vidros				Selección de perfiles Seleção de perfis		
Medidas extensibilidad Medidas extensibilidade	Medidas extensibilidad para platos a ras de suelo	Medidas extensibilidad Medidas extensibilidade	Fijo frontal Fijo frontal	Entrada				1	4	56	57	D	B	K
A	G	B	F1	F2	*									
76,5↔79,5	75,1↔78,1	-	23	-	38	ROSER80-	-	-				1.352 €	1.487 €	1.637 €
86,5↔89,5	85,1↔88,1	-	33	-	51	ROSER90-	-	-	+ 80 €	+ 80 €	+ 80 €	1.429 €	1.571 €	1.728 €
96,5↔99,5	95,1↔98,1	-	43	-	51	ROSER100-	-	-				1.486 €	1.636 €	1.800 €
VERSIÓN ASIMÉTRICA / VERSÃO ASSIMÉTRICA														
76,5↔79,5	75,1↔78,1	96↔99,5	23	43	44	ROSER80100	D-	S-				1.428 €	1.569 €	1.726 €
76,5↔79,5	75,1↔78,1	116,5↔119,5	23	63	44	ROSER80120	D-	S-	+ 80 €	+ 80 €	+ 80 €	1.487 €	1.637 €	1.801 €
86,5↔89,5	85,1↔88,1	96↔99,5	33	43	51	ROSER90100	D-	S-				1.458 €	1.603 €	1.763 €
86,5↔89,5	85,1↔88,1	116,5↔119,5	33	63	51	ROSER90120	D-	S-				1.519 €	1.672 €	1.839 €

VERSIÓN ASIMÉTRICA SÓLO PARA INSTALACIONES A RAS DE SUELO
VERSÃO ASSIMÉTRICA SÓ PARA INSTALAÇÕES AO NÍVEL DO CHÃO

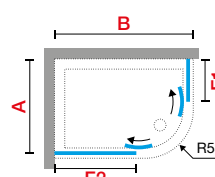
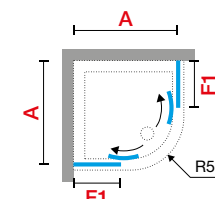
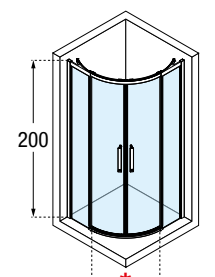

S Izquierda
 Esquerda

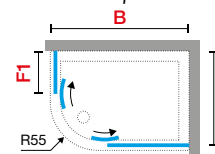

D Derecha
 Direita

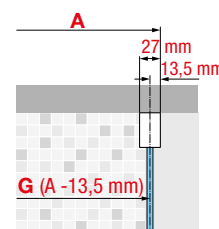

¡IMPORTANTE!
INDICAR EN PEDIDO SI EL PLATO ES SOBREELEVADO O A RAS DE SUELO
INDICAR NA ENCOMENDA SE A BASE É SOBRE ELEVADO O A NÍVEL DO CHÃO

Construcción del código:
 Construção do código

Código

+ Izquierda / Derecha
 Esquerda / Direita

+ Cristales
 Vidros

+ Perfiles
 Perfis

= Código completo del producto
 Código completo do produto

ROSE F

PANEL FIJO
PAINEL FIXO



200 cm



6 mm



3 cm



CRISTAL TEMPLADO VIDRO TEMPERADO



Transparente
cod 1



Satinado
Fosco
cod 4



Ser. Rose 1
cod 56



Ser. Rose 2
cod 57

COLORES PERFILES CORES PERFÍS



Blanco
Branco
cod. D



Silver
Abrillantado
cod. B



Cromo
cod K

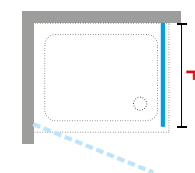
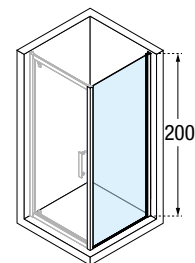

Medidas		Código	Selección Cristales Seleção Vidros				Selección de perfiles Seleção de perfis		
Medidas extensibilidad Medidas extensibilidade	Medidas extensibilidad para platos a ras de suelo		1	4	56	57	D	B	K
F	G		Transparente	Satinado Fosco	Ser. Rose 1	Ser. Rose 2	Blanco Branco	Silver Brillantado	Cromo
66↔69	64,6↔67,6	ROSEF66-					392 €	432 €	476 €
68↔71	66,6↔69,6	ROSEF68-					392 €	432 €	476 €
71↔74	69,6↔72,6	ROSEF71-					408 €	449 €	495 €
73↔76	71,6↔74,6	ROSEF73-					408 €	449 €	495 €
75↔78	73,6↔76,6	ROSEF75-					423 €	465 €	512 €
78↔81	76,6↔79,6	ROSEF78-					423 €	465 €	512 €
81↔84	79,6↔82,6	ROSEF81-					423 €	465 €	512 €
83↔86	81,6↔84,6	ROSEF83-		+ 40 €	+ 40 €	+ 40 €	423 €	465 €	512 €
85↔88	83,6↔86,6	ROSEF85-					437 €	480 €	529 €
88↔91	86,6↔89,6	ROSEF88-					437 €	480 €	529 €
91↔94	89,6↔92,6	ROSEF91-					437 €	480 €	529 €
93↔96	91,6↔94,6	ROSEF93-					437 €	480 €	529 €
95↔98	93,6↔96,6	ROSEF95-					453 €	497 €	549 €
98↔101	96,6↔99,6	ROSEF98-					453 €	497 €	549 €
108↔111	106,6↔109,6	ROSEF108-					470 €	516 €	569 €
118↔121	116,6↔119,6	ROSEF118-					485 €	533 €	588 €

PARA MEDIDAS Y RECORTES ESPECIALES, POR FAVOR CONSULTA A TU DELEGADO O AL SERVICIO DE ATENCIÓN COMERCIAL

PARA LAS SOLUCIONES CON DOS PANELES FIJOS LATERALES, UTILIZAR SIEMPRE 2 BARRAS DE SUJECIÓN EN ÁNGULO

PARA AS SOLUÇÕES COM DOIS PAINÉIS FIXOS LATERAIS, UTILIZAR SEMPRE 2 BARRAS DE SUJEIÇÃO EM ÂNGULO

IMPORTANTE!
INDICAR EN PEDIDO SI EL PLATO ES SOBREELEVADO O A RAS DE SUELO
INDICAR NA ENCOMENDA SE A BASE É SOBRE ELEVADO O A NÍVEL DO CHÃO

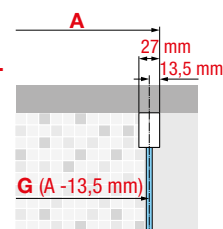

DATOS TÉCNICOS / DADOS TÉCNICOS

COLORES PERFILES / CORES PERFÍS



Blanco
Branco
cod. D



Silver
Abrillantado
cod. B



Cromo
cod. K



CRISTAL TEMPLADO / VIDRO TEMPERADO 6 mm (Según norma Europea UNE EN 14428)



Transparente
cod. 1



Satinado
Fosco
cod. 4

SERIGRAFIA



Rose 1
cod. 56



Rose 2
cod. 57

TIRADOR / PUXADOR

OPCIONAL



Tirador de cristal
Puxador em vidro
Distancia entre
agujeros 256 mm



Tirador cromo
Puxador cromo



Tirador cromo
Puxador cromo



Tirador cromo
Puxador cromo



Tirador cromo
Puxador cromo

Código	Precio Preço
R40MACNF1-K	76 €

Código	Precio Preço
R40MAGIN1-K	69 €

Código	Precio Preço
R40EIMAGIN1-K	120 €

Código	Precio Preço
R40EIMACNF1-K	126 €

Para otros tiradores consultar (pág. 586)

MEDIDAS QUE OCUPAN LOS PERFILES EN LA PARED / ESPAÇO QUE OCUPAN OS PERFÍS NA PAREDE

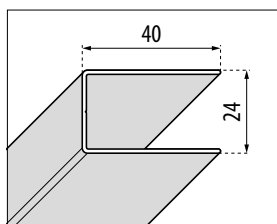

A PARED
R - PH+F - A - 3PH

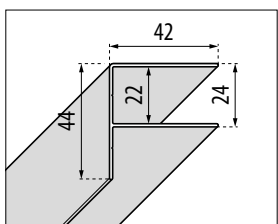

A PARED
2A - B - 3P - G - S - 2M - 2P

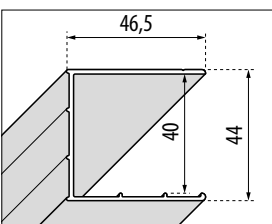

A PARED
PHB

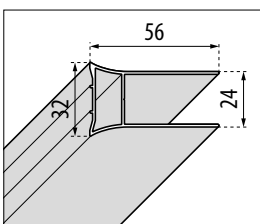

COMPENSADORES
R - PH+F - A - 3PH

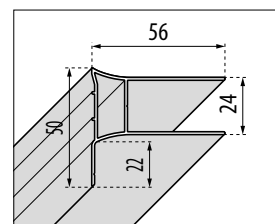

COMPENSADORES
2A - B - 3P - G - S - 2M - 2P

Color perfil Cores perfil	Código
Blanco / Branco	P01BEAST-A
Silver / Brillantado	P01BEAST-B
Cromo	P01BEAST-K

Color perfil Cores perfil	Código
Blanco / Branco	P01BEGST-A
Silver / Brillantado	P01BEGST-B
Cromo	P01BEGST-K

Color perfil Cores perfil	Código
Blanco / Branco	P01KUM01ST-A
Silver / Brillantado	P01KUM01ST-B
Cromo	P01KUM01ST-K

Color perfil Cores perfil	Código
Blanco / Branco	P05ROSST-A
Silver / Brillantado	P05ROSST-B
Cromo	P05ROSST-K

Color perfil Cores perfil	Código
Blanco / Branco	P05ROSCST-A
Silver / Brillantado	P05ROSCST-B
Cromo	P05ROSCST-K

TOMA DE MEDIDAS

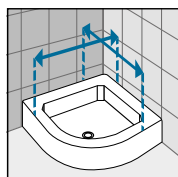
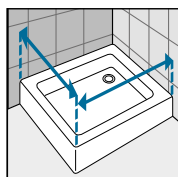

Tomar las medidas desde la pared hasta el borde externo del plato de ducha.

Medir a distância desde a parede até o rebordo externo da base de chuveiro.

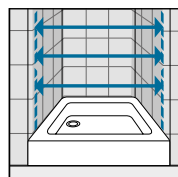

Tomar medidas de pared a pared, medir la parte baja, la central y la superior. Cursar el pedido con la medida más pequeña.

Medir a distância entre paredes, tem que tirar três medidas (inferior, superior e central) e utilizar a inferior. Encomendar pedido da medida mais pequena.

ZEPHYROS 2.0

INFINITAS COMPOSICIONES
DE BIENESTAR.

INFINITAS COMPOSIÇÕES
DE BEM-ESTAR



◀ Tirador nuevo
Puxador novo



◀ Reversible. Dispositivo de
desbloqueo de puerta
(excepto modelos PH / AH)
*Reversível. Dispositivo de
libertação de portas
(excepto para os modelos
PH / AH)*



◀ Nuevo sistema de liberación
de puerta incluido (para
modelos PH / AH)
*Nuevo sistema de extração
das portas incluído (para
modelos PH/AH)*



TRATAMIENTOS / TRATAMENTOS





ZEPHYROS 2.0

ZEPHYROS 2.0 PH+FH



200 cm



6 mm



3 cm



puerta
porta



Fijo
Fixo



MAMPARA DE 2 HOJAS: 1 CORREDERA + 1 FIJA + PANEL FIJO LATERAL SIN PERFIL ANGULAR
ANGULAR DE DUAS PORTS DE CORRER + DOS FIXOS

Medidas			Código	Derecha	Izquierda	Selección Cristales				Selección de perfiles			
Medidas extensibilidad	Fijo frontal	Entrada		Dereita	Esquerda	1	4	11	91	U	B	K	H
Medidas extensibilidad	Medidas Fijo frontal			D-	S-	Transparente	Satinado Fosco	Niva	Serigrafía Strip	Blanco mate Branco mate	Silver Abrillantado	Cromo	Negro mate
A	F1	*											
PUERTA / PORTA													
96↔99	48	39	ZEP2PH96	D-	S-					782 €	880 €	978 €	978 €
114↔117	57	48	ZEP2PH114	D-	S-					875 €	972 €	1.070 €	1.070 €
116↔119	58	49	ZEP2PH116	D-	S-					875 €	972 €	1.070 €	1.070 €
126↔129	63	54	ZEP2PH126	D-	S-					936 €	1.036 €	1.132 €	1.132 €
136↔139	68	59	ZEP2PH136	D-	S-	+ 40 €	+ 40 €	+ 40 €		956 €	1.053 €	1.150 €	1.150 €
146↔149	73	64	ZEP2PH146	D-	S-					984 €	1.081 €	1.180 €	1.180 €
156↔159	78	69	ZEP2PH156	D-	S-					1.032 €	1.129 €	1.227 €	1.227 €
166↔169	83	74	ZEP2PH166	D-	S-					1.049 €	1.148 €	1.246 €	1.246 €
H 160↕200 L 96↔166	ESPECIAL		ZEP2PHSP			+ 40 €	+ 40 €	-		1.255 €	1.376 €	1.513 €	1.513 €

FIJO PANEL REVERSIBLE / FIXO PAINEL REVERSÍVEL													
FH													
Medidas extensibilidad	Medidas Fijo frontal	Entrada	Código	Derecha	Izquierda	1	4	11	91	U	B	K	H
Medidas extensibilidad	Medidas Fijo frontal			D-	S-	Transparente	Satinado Fosco	Niva	Serigrafía Strip	Blanco mate Branco mate	Silver Abrillantado	Cromo	Negro mate
A	F1	*											
67↔70	-	-	ZEP2FH67-	-	-					360 €	392 €	423 €	423 €
73↔76	-	-	ZEP2FH73-	-	-					360 €	392 €	423 €	423 €
77↔80	-	-	ZEP2FH77-	-	-	+ 40 €	+ 40 €	+ 40 €		376 €	406 €	437 €	437 €
87↔90	-	-	ZEP2FH87-	-	-					392 €	423 €	453 €	453 €
97↔100	-	-	ZEP2FH97-	-	-					407 €	438 €	469 €	469 €
117↔120	-	-	ZEP2FH117-	-	-					407 €	438 €	469 €	469 €
H 160↕200 L 20↔117	ESPECIAL		ZEP2FHSP			+ 40 €	+ 40 €	-		474 €	533 €	590 €	590 €

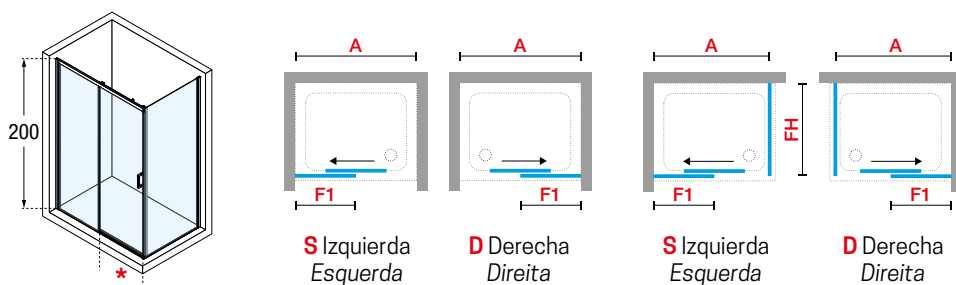

070

Construcción del código:
Construção do código

Código

+ **Izquierda / Derecha**
Esquerda / Direita

+ **Cristales**
Vidros

+ **Perfiles**
Perfis

= **Código completo del producto**
Código completo do produto

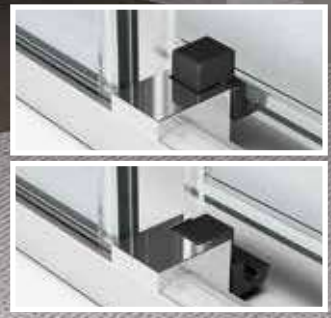

SISTEMA DE LIBERACIÓN DE PUERTA INCLUIDO
SISTEMA DE EXTRAÇÃO DAS PORTAS INCLUIDO

CRISTAL TEMPLADO / VIDRO TEMPERADO



Transparente
cod 1

Satinado
Fosco
cod 4

Niva
cod 11

Strip
cod 91

COLORES PERFILES / CORES PERFÍS

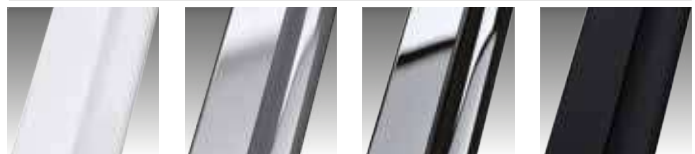

Blanco Mate
Branco Mate
cod. U

Silver
Abrillantado
cod. B

Cromo
cod. K

Negro mate
cod. H

ZEPHYROS 2.0 2P



PUERTA DE DOS HOJAS: UNA CORREDERA + UNA FIJA
RESGUARDO DE DUAS FOLHAS: UNA DE CORRER + UNA FIXA

Medidas			Código	Selección Cristales Seleção Vidros				Selección de perfiles Seleção de perfis			
Medidas extensibilidad Medidas extensibilidade	Fijo frontal Fixo frontal	Entrada		1	4	11	91	U	B	K	H
A	F1	*		Transparente	Satinado Fosco	Niva	Serigrafía Strip	Blanco mate Branco mate	Silver Abrillantado	Cromo	Negro mate
96↔102	44	37	ZEP22P96-					744 €	837 €	931 €	931 €
114↔120	53	46	ZEP22P114-					832 €	925 €	1.018 €	1.018 €
116↔122	54	47	ZEP22P116-					832 €	925 €	1.018 €	1.018 €
126↔132	59	52	ZEP22P126-					890 €	985 €	1.078 €	1.078 €
136↔142	64	57	ZEP22P136-		+ 40 €	+ 40 €	+ 40 €	909 €	1.002 €	1.095 €	1.095 €
146↔152	69	62	ZEP22P146-					936 €	1.030 €	1.123 €	1.123 €
156↔162	74	67	ZEP22P156-					983 €	1.075 €	1.168 €	1.168 €
166↔172	79	72	ZEP22P166-					1.000 €	1.092 €	1.186 €	1.186 €
H 160↔200 L 96↔166	ESPECIAL		ZEP22PSP		+ 40 €	+ 40 €	-	1.195 €	1.309 €	1.439 €	1.439 €

SE PUEDE PEDIR UN FIJO LATERAL PARA CUBRIR 3 LADOS
PODE-SE PEDIR UM FIXO LATERAL PARA COMPLETAR 3 LADOS

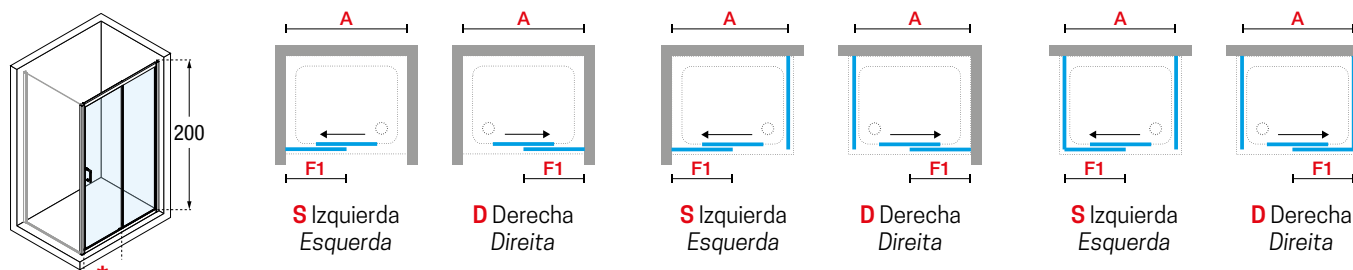



DISPOSITIVO DE DESBLOQUEO
DE PUERTA INSTALADO
PUERTA REVERSIBLE

DISPOSITIVO DE LIBERTAÇÃO DE
PORTAS MONTADO
PORTA REVERSÍVEL



CRISTAL TEMPLADO / VIDRO TEMPERADO



Transparente
cod 1

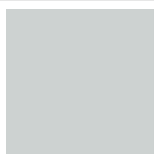

Satinado
Fosco
cod 4



Niva
cod 11



Strip
cod 91

COLORES PERFILES / CORES PERFÍS



Blanco Mate
Branco Mate
cod. U



Silver
Abrillantado
cod. B



Cromo
cod. K



Negro mate
cod. H

ZEPHYROS 2.0 2A



FRONTAL DE DOS HOJAS CORREDERAS + DOS FIJOS
RESGUARDO DE DUAS FOLHAS DE CORRER + DOS FIXOS

Medidas			Código	Selección Cristales Seleção Vidros				Selección de perfiles Seleção de perfis			
Medidas extensibilidad Medidas extensibilidade	Fijo frontal Fixo frontal	Entrada		1	4	11	91	U	B	K	H
A	F1	*		Transparente	Satinado Fosco	Niva	Serigrafia Strip	Blanco mate Branco mate	Silver Abrillantado	Cromo	Negro mate
67↔70	30	34	ZEP2A67L-	+ 40 €	+ 40 €	+ 40 €		421 €	471 €	522 €	492 €
72↔75	33	37	ZEP2A72L-				421 €	471 €	522 €	492 €	
74↔77	34	39	ZEP2A74L-				421 €	471 €	522 €	492 €	
77↔80	35	41	ZEP2A77L-				449 €	500 €	550 €	519 €	
82↔85	38	44	ZEP2A82L-				449 €	500 €	550 €	519 €	
87↔90	40	48	ZEP2A87L-				449 €	500 €	550 €	519 €	
92↔95	43	51	ZEP2A92L-				495 €	544 €	594 €	560 €	
97↔100	45	55	ZEP2A97L-				495 €	544 €	594 €	560 €	
102↔105	48	59	ZEP2A102L-				506 €	555 €	606 €	572 €	
107↔110	50	62	ZEP2A107L-				506 €	555 €	606 €	572 €	
112↔115	53	66	ZEP2A112L-				517 €	567 €	618 €	583 €	
117↔120	55	69	ZEP2A117L-				517 €	567 €	618 €	583 €	

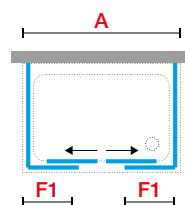
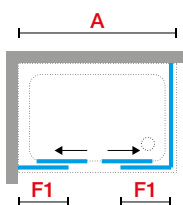
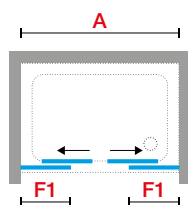
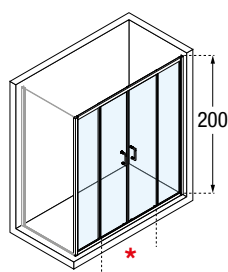



DISPOSITIVO DE DESBLOQUEO DE PUERTA INCLUIDO
DISPOSITIVO DE LIBERTAÇÃO DE PORTAS INCLUIDO

CRISTAL TEMPLADO / VIDRO TEMPERADO



Transparente
cod 1

Satinado
Fosco
cod 4

Niva
cod 11

Strip
cod 91

COLORES PERFILES / CORES PERFÍS

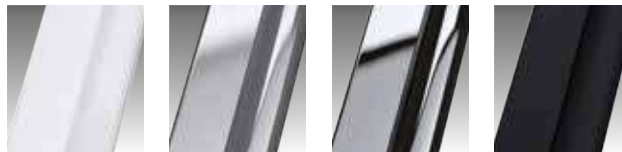

Blanco Mate
Branco Mate
cod. U

Silver
Abrillantado
cod. B

Cromo
cod. K

Negro mate
cod. H

ZEPHYROS 2.0 AH



MAMPARA ANGULAR DE DOS PUERTAS CORREDAS + DOS FIJOS
RESGUARDO ANGULAR DE DUAS PORTAS DE CORRER + DOS FIXOS

Medidas			Código	Derecha Direita	Izquierda Esquerda	Selección Cristales Seleção Vidros				Selección de perfiles Seleção de perfis			
Medidas extensibilidad Medidas extensibilidade	Fijo frontal Fixo frontal	Entrada		D-	S-	1	4	11	91	U	B	K	H
A	F1	*				Transparente	Satinado Fosco	Niva	Serigrafia Strip	Blanco mate Branco mate	Silver Abrillantado	Cromo	Negro mate
67↔70	30	34	ZEP2AH67L	D-	S-	+ 40 €	+ 40 €	+ 40 €		442 €	495 €	548 €	548 €
72↔75	33	37	ZEP2AH72L	D-	S-					442 €	495 €	548 €	548 €
74↔77	34	39	ZEP2AH74L	D-	S-					442 €	495 €	548 €	548 €
77↔80	35	41	ZEP2AH77L	D-	S-					472 €	525 €	578 €	578 €
82↔85	38	44	ZEP2AH82L	D-	S-					472 €	525 €	578 €	578 €
87↔90	40	48	ZEP2AH87L	D-	S-					472 €	525 €	578 €	578 €
92↔95	43	51	ZEP2AH92L	D-	S-					519 €	571 €	624 €	624 €
97↔100	45	55	ZEP2AH97L	D-	S-					519 €	571 €	624 €	624 €
102↔105	48	59	ZEP2AH102L	D-	S-					532 €	583 €	636 €	636 €
107↔110	50	62	ZEP2AH107L	D-	S-					532 €	583 €	636 €	636 €
112↔115	53	66	ZEP2AH112L	D-	S-	544 €	597 €	650 €	650 €				
117↔120	55	69	ZEP2AH117L	D-	S-	544 €	597 €	650 €	650 €				

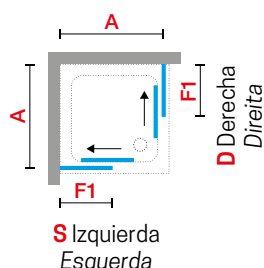
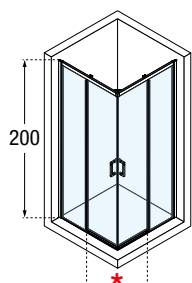

076



Construcción del código:
Construção do código

Código

+ **Izquierda / Derecha
Esquerda / Direita**

+ **Cristales
Vidros**

+ **Perfiles
Perfis**

= **Código completo del producto
Código completo do produto**



DISPOSITIVO DE DESBLOQUEO DE PUERTA INCLUIDO
DISPOSITIVO DE LIBERTAÇÃO DE PORTAS INCLUIDO

CRISTAL TEMPLADO / VIDRO TEMPERADO



Transparente
cod 1

Satinado
Fosco
cod 4

Niva
cod 11

Strip
cod 91

COLORES PERFILES / CORES PERFÍIS

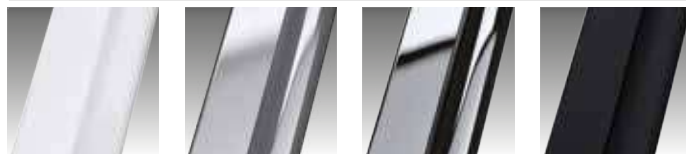

Blanco Mate
Branco Mate
cod. U

Silver
Abrillantado
cod. B

Cromo
cod. K

Negro mate
cod. H

ZEPHYROS 2.0 A



MAMPARA ANGULAR DE DOS PUERTAS CORREDERAS + DOS FIJOS
RESGUARDO ANGULAR DE DUAS PORTS DE CORRER + DOS FIXOS

Medidas			Código	Selección Cristales Seleção Vidros				Selección de perfiles Seleção de perfis			
Medidas extensibilidad Medidas extensibilidade	Fijo frontal Fixo frontal	Entrada		1	4	11	91	U	B	K	H
A	F1	*		Transparente	Satinado Fosco	Niva	Serigrafía Strip	Blanco mate Branco mate	Silver Abrillantado	Cromo	Negro mate
67↔70	30	34	ZEP2A67L-	+ 40 €	+ 40 €	+ 40 €		421 €	471 €	522 €	492 €
72↔75	33	37	ZEP2A72L-				421 €	471 €	522 €	492 €	
74↔77	34	39	ZEP2A74L-				421 €	471 €	522 €	492 €	
77↔80	35	41	ZEP2A77L-				449 €	500 €	550 €	519 €	
82↔85	38	44	ZEP2A82L-				449 €	500 €	550 €	519 €	
87↔90	40	48	ZEP2A87L-				449 €	500 €	550 €	519 €	
92↔95	43	51	ZEP2A92L-				495 €	544 €	594 €	560 €	
97↔100	45	55	ZEP2A97L-				495 €	544 €	594 €	560 €	
102↔105	48	59	ZEP2A102L-				506 €	555 €	606 €	572 €	
107↔110	50	62	ZEP2A107L-				506 €	555 €	606 €	572 €	
112↔115	53	66	ZEP2A112L-				517 €	567 €	618 €	583 €	
117↔120	55	69	ZEP2A117L-				517 €	567 €	618 €	583 €	

PARA COMPONER UN ÁNGULO PEDIR 2 LATERALES
FORMAR UM ÂNGULO PEDINDO DOIS LATERAIS

SE PUEDE PEDIR UN FIJO LATERAL PARA CUBRIR 3 LADOS
PODE-SE PEDIR UM FIXO LATERAL PARA COMPLETAR 3 LADOS

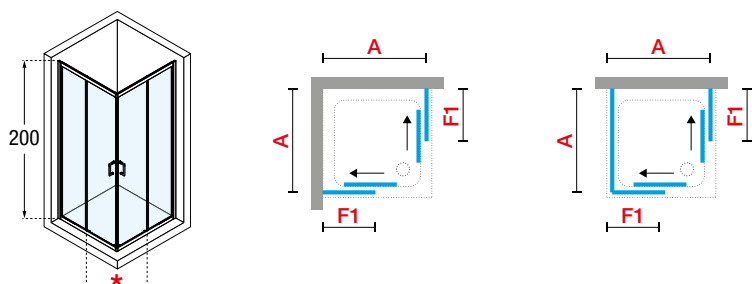

078



Construcción del código:
 Construção do código

Código

+

**Cristales
Vidros**

+

**Perfiles
Perfis**

=

Código completo del producto
 Código completo do produto



SISTEMA DE LIBERACIÓN DE PUERTA INCLUIDO
SISTEMA DE EXTRAÇÃO DAS PORTAS INCLUIDO

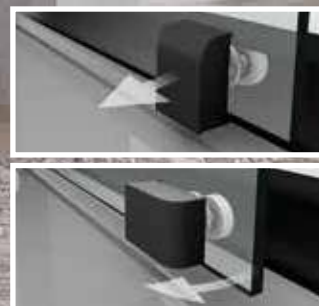

CRISTAL TEMPLADO / VIDRO TEMPERADO



Transparente
cod 1

Satinado
Fosco
cod 4

Niva
cod 11

Strip
cod 91

COLORES PERFILES / CORES PERFÍS

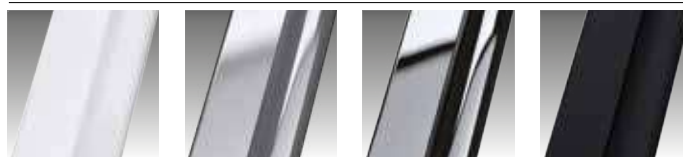

Blanco Mate
Branco Mate
cod. U

Silver
Abrillantado
cod. B

Cromo
cod. K

Negro mate
cod. H

ZEPHYROS 2.0 2B

MAMPARA DE DUCHA DE DOS HOJAS ABATIBLES
RESGUARDO DE DUCHE DE DUAS FOLHAS ABATIVELIS



200 cm



6 mm



6 cm



CRISTAL TEMPLADO VIDRO TEMPERADO



Transparente
cod 1



Satinado
Fosco
cod 4



Niva
cod 11



Ser.Strip
cod 91

COLORES PERFILES CORES PERFÍS



Blanco
Branco
cod. U



Silver
Abrillantado
cod. B



Cromo
cod K



Negro mate
cod H

Medidas			Código	Selección Cristales Seleção Vidros				Selección de perfiles Seleção de perfis			
Medidas extensibilidad Medidas extensibilidade	Espacio de apertura Espaço de abertura	Entrada		1	4	11	91	U	B	K	H
A	B	*		Transparente	Satinado Fosco	Niva	Serigrafía Strip	Blanco mate Branco mate	Silver Abrillantado	Cromo	Negro mate
66↔72	26	55	ZEP22B66-					654 €	726 €	802 €	802 €
72↔78	29	61	ZEP22B72-					683 €	758 €	834 €	834 €
76↔82	31	65	ZEP22B76-		+ 40 €	+ 40 €	+ 40 €	713 €	789 €	863 €	863 €
86↔92	36	75	ZEP22B86-					745 €	819 €	895 €	895 €
96↔102	41	85	ZEP22B96-					776 €	848 €	924 €	924 €

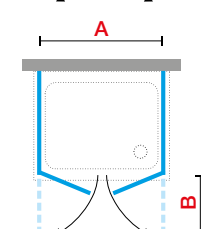
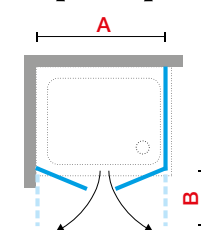
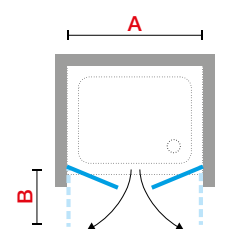
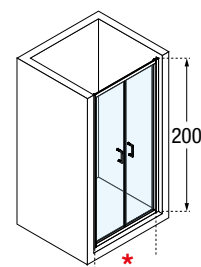

SE PUEDE PEDIR UN FIJO LATERAL PARA CUBRIR 3 LADOS
PODE-SE PEDIR UM FIXO LATERAL PARA COMPLETAR 3 LADOS

ZEPHYROS 2.0 S



200 cm



6 mm



6 cm



MAMPARA PLEGABLE DE DOS HOJAS
RESGUARDO DESDOBRÁVEL DE DUAS FOLHAS



BISAGRAS ATORNILLADAS

CRISTAL TEMPLADO VIDRO TEMPERADO



Transparente
cod 1



Satinado
Fosco
cod 4



Niva
cod 11



Ser.Strip
cod 91

COLORES PERFILES CORES PERFIS



Blanco
Branco
cod. U



Silver
Abrillantado
cod. B



Cromo
cod K



Negro mate
cod H

Medidas			Código	Selección Cristales Seleção Vidros				Selección de perfiles Seleção de perfis			
Medidas extensibilidad Medidas extensibilidade	Tamaño puerta	Entrada		1	4	11	91	U	B	K	H
A	B	*		Transparente	Satinado Fosco	Niva	Serigrafía Strip	Blanco mate Branco mate	Silver Abrillantado	Cromo	Negro mate
66↔72	31	46	ZEP2S66-					739 €	819 €	901 €	901 €
72↔78	34	52	ZEP2S72-					752 €	834 €	916 €	916 €
76↔82	36	56	ZEP2S76-	+ 40 €	+ 40 €	+ 40 €		783 €	864 €	947 €	947 €
86↔92	41	66	ZEP2S86-					797 €	879 €	961 €	961 €
96↔102	46	76	ZEP2S96-					829 €	909 €	991 €	991 €

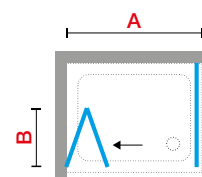
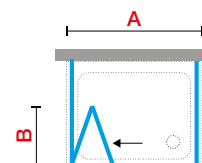
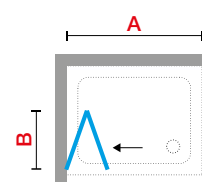
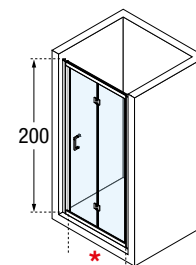

SE PUEDE PEDIR UN FIJO LATERAL PARA CUBRIR 3 LADOS
PODE-SE PEDIR UM FIXO LATERAL PARA COMPLETAR 3 LADOS

Construcción del código: **Código** + **Cristales Vidros** + **Perfiles Perfis** = Código completo del producto
Construção do código: **Código** + **Cristales Vidros** + **Perfiles Perfis** = Código completo do produto

ZEPHYROS 2.0 S IN OUT



200 cm



6 mm



6 cm



MAMPARA PLEGABLE DE DOS HOJAS CON APERTURA EXTERIOR DE SEGURIDAD
RESGUARDO DESDOBRÁVEL DE DUAS FOLHAS COM APERTURA EXTERIOR DE SEGURANÇA



CRISTAL TEMPLADO VIDRO TEMPERADO



Transparente
cod 1



Satinado
Fosco
cod 4



Niva
cod 11



Ser.Strip
cod 91

COLORES PERFILES CORES PERFÍS



Blanco
Branco
cod. U



Silver
Abrillantado
cod. B



Cromo
cod K



Negro mate
cod H

Medidas			Código	Selección Cristales Seleção Vidros				Selección de perfiles Seleção de perfis			
Medidas extensibilidad Medidas extensibilidade	Tamaño puerta	Entrada		1	4	11	91	U	B	K	H
A	B	*		Transpa- rente	Satinado Fosco	Niva	Serigrafía Strip	Blanco mate Branco mate	Silver Abrillantado	Cromo	Negro mate
66↔72	31	46	ZEP2S266-					782 €	867 €	951 €	951 €
72↔78	34	52	ZEP2S272-					795 €	880 €	965 €	965 €
76↔82	36	56	ZEP2S276-	+ 40 €	+ 40 €	+ 40 €		825 €	908 €	993 €	993 €
86↔92	41	66	ZEP2S286-					840 €	924 €	1.009 €	1.009 €
96↔102	46	76	ZEP2S296-					875 €	959 €	1.043 €	1.043 €

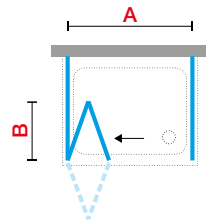
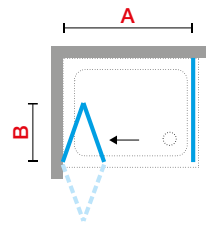
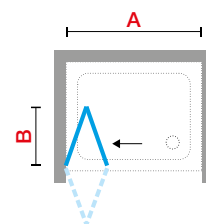
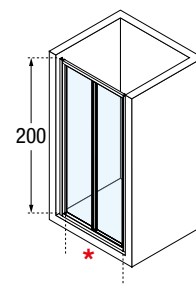

SE PUEDE PEDIR UN FIJO LATERAL PARA CUBRIR 3 LADOS
PODE-SE PEDIR UM FIXO LATERAL PARA COMPLETAR 3 LADOS



APERTURA DE EMERGENCIA.
ATENCIÓN: LA APERTURA HACIA EL EXTERIOR SÓLO DEBE CONSIDERARSE
UNA APERTURA DE EMERGENCIA

ABERTURA DE EMERGÊNCIA.
ATENÇÃO: A ABERTURA PARA O EXTERIOR SÓ DEVE SER CONSIDERADA
COMO UMA ABERTURA DE EMERGÊNCIA

ZEPHYROS 2.0 3P

MAMPARA DE TRES HOJAS CORREDERAS
RESGUARDO DE TRES FOLHAS DE CORRER



200 cm



6 mm



6 cm



CRISTAL TEMPLADO VIDRO TEMPERADO



Transparente
cod 1



Satinado
Fosco
cod 4



Niva
cod 11



Ser.Strip
cod 91

COLORES PERFILES CORES PERFÍS



Blanco
Branco
cod. U



Silver
Abrillantado
cod. B



Cromo
cod K



Negro mate
cod H

Medidas		Código	Selección Cristales Seleção Vidros				Selección de perfiles Seleção de perfis			
Medidas extensibilidad Medidas extensibilidade	Entrada		1	4	11	91	U	B	K	H
A	*		Transpa- rente	Satinado Fosco	Niva	Serigrafía Strip	Blanco mate Branco mate	Silver Abrillantado	Cromo	Negro mate
96↔102	41	ZEP23P96-					829 €	914 €	996 €	996 €
106↔112	48	ZEP23P106-					843 €	928 €	1.014 €	1.014 €
116↔122	54	ZEP23P116-		+ 40 €	+ 40 €	+ 40 €	873 €	958 €	1.042 €	1.042 €
126↔132	61	ZEP23P126-					904 €	989 €	1.074 €	1.074 €
136↔142	68	ZEP23P136-					937 €	1.022 €	1.107 €	1.107 €

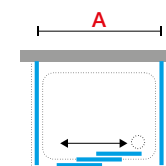
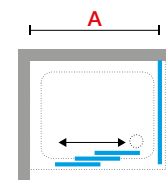
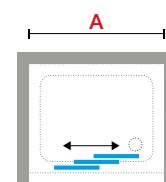
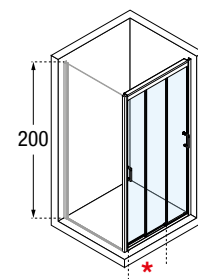

SE PUEDE PEDIR UN FIJO LATERAL PARA CUBRIR 3 LADOS
PODE-SE PEDIR UM FIXO LATERAL PARA COMPLETAR 3 LADOS

Construcción del código: Código + Cristales Vidros + Perfiles Perfis = Código completo del producto
Construção do código

ZEPHYROS 2.0 G

MAMPARA DE DUCHA ABATIBLE DE UNA HOJA
RESGUARDO DE DUCHE DE ABRIR DE UMA FOLHA



200 cm



6 mm



6 cm



VERSIÓN
SERIGRAFIA STRIPES

CRISTAL TEMPLADO VIDRO TEMPERADO



Transparente
cod 1



Satinado
Fosco
cod 4



Niva
cod 11



Ser.Strip
cod 91



Stripes
cod 82

COLORES PERFILES CORES PERFÍS



Blanco
Branco
cod. U



Silver
Abrillantado
cod. B



Cromo
cod K



Negro mate
cod H

Medidas			Código	Selección Cristales Seleção Vidros					Selección de perfiles Seleção de perfis			
Medidas extensibilidad Medidas extensibilidade	Espacio de apertura Espaço de abertura	Entrada		1	4	11	91	82	U	B	K	H
A	B	*		Transparente	Satinado Fosco	Niva	Serigrafía Strip	Stripes	Blanco mate Branco mate	Silver Abrillantado	Cromo	Negro mate
66↔72	54	54	ZEP2G66-						553 €	613 €	671 €	671 €
72↔78	60	60	ZEP2G72-						553 €	613 €	671 €	671 €
76↔82	64	64	ZEP2G76-	+ 40 €	+ 40 €	+ 40 €	+ 133 €		570 €	629 €	689 €	689 €
86↔92	74	74	ZEP2G86-						599 €	659 €	718 €	718 €
96↔102	84	84	ZEP2G96-						630 €	691 €	749 €	749 €
H 160†200 L 66↔96	SPECIAL		ZEP2GSP	+ 40 €	+ 40 €	-	-		734 €	800 €	883 €	883 €

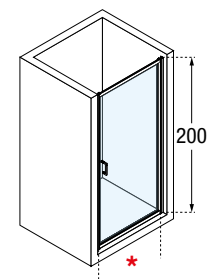

ZEPHYROS 2.0 F STRIPES

Medidas	Código	Selección Cristales Seleção Vidros	Selección de perfiles Seleção de perfis
Medidas extensibilidad Medidas extensibilidade		82	H
F		Stripes	Negro mate
66↔69	ZEP2FN66-		402 €
68↔71	ZEP2FN68-		402 €
73↔76	ZEP2FN73-		402 €
76↔79	ZEP2FN76-		416 €
78↔81	ZEP2FN78-		416 €
83↔86	ZEP2FN83-	+ 133 €	416 €
88↔91	ZEP2FN88-		429 €
93↔96	ZEP2FN93-		429 €
98↔101	ZEP2FN98-		445 €
118↔121	ZEP2FN118-		445 €

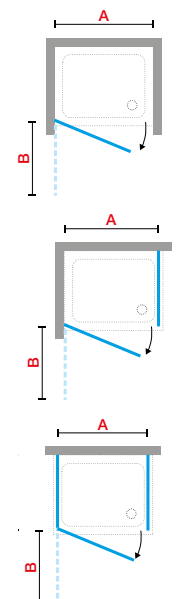

LA SERIGRAFIA "STRIPES" SÓLO SE PUEDE COMBINAR CON EL PERFIL NEGRO MATE PARA FIJACIONES EN OTROS ACABADOS, VÉASE ZEPHYROS 2.0 F (PÁGINA 086)

A IMPRESSÃO EM ECRÃ 'STRIPES' SÓ PODE SER COMBINADA COM PERFIL PRETO MATE PARA FIXAÇÕES EM OUTROS ACABAMENTOS VER ZEPHYROS 2.0 F (PÁGINA 086)

SE PUEDE PEDIR UN FIJO LATERAL PARA CUBRIR 3 LADOS / PODE-SE PEDIR UM FIXO LATERAL PARA COMPLETAR 3 LADOS

084 Construcción del código: Código + Cristales Vidros + Perfiles Perfis = Código completo del producto
Construção do código

ZEPHYROS 2.0 R



200 cm



6 mm



3 cm



MAMPARA SEMICIRCULAR DE DOS PUERTAS CORREDERAS + DOS FIJOS
RESGUARDO PARA BASE SEMICIRCULAR COMPUESTO POR DUAS PORTAS DE CORRER



DISPOSITIVO DE DESBLOQUEO DE PUERTA INCLUIDO
 DISPOSITIVO DE LIBERTAÇÃO DE PORTAS INCLUIDO

CRISTAL TEMPLADO VIDRO TEMPERADO



Transparente
cod 1



Satinado
Fosco
cod 4



Niva
cod 11



Ser.Strip
cod 91

COLORES PERFILES CORES PERFÍS



Blanco
Branco
cod. U



Silver
Abrillantado
cod. B



Cromo
cod K



Negro mate
cod H

Medidas			Código	Selección Cristales Seleção Vidros				Selección de perfiles Seleção de perfis			
Medidas extensibilidad Medidas extensibilidade	Fijo frontal Fijo frontal	Entrada		1	4	11	91	U	B	K	H
A	F1	*		Transparente	Satinado Fosco	Niva	Serigrafía Strip	Blanco mate Branco mate	Silver Abrillantado	Cromo	Negro mate
77,5↔80,5	24	42	ZEP2R80-					1.239 €	1.376 €	1.511 €	1.511 €
87,5↔90,5	34	52	ZEP2R90-	+ 80 €	+ 80 €	+ 80 €		1.314 €	1.450 €	1.587 €	1.587 €
97,5↔100,5	44	52	ZEP2R100-					1.391 €	1.525 €	1.662 €	1.662 €

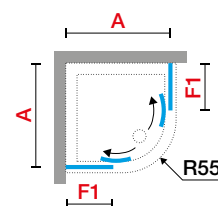
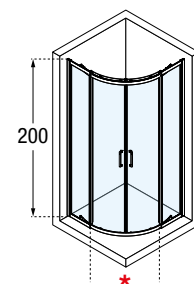

ZEPHYROS 2.0 F

PANEL FIJO
PAINEL FIXO



200 cm



6 mm



3 cm



CRISTAL TEMPLADO VIDRO TEMPERADO



Transparente
cod 1



Satinado
Fosco
cod 4



Niva
cod 11



Ser. Strip
cod 91

COLORES PERFILES CORES PERFÍS



Blanco
Branco
cod. U



Silver
Abrillantado
cod. B



Cromo
cod K



Negro mate
cod H

Medidas	Código	Selección Cristales Seleção Vidros				Selección de perfiles Seleção de perfis			
		1	4	11	91	U	B	K	H
F		Transparente	Satinado Fosco	Niva	Serigrafía Strip	Blanco mate Branco mate	Silver Abrillantado	Cromo	Negro mate
66↔69	ZEP2F66-					343 €	373 €	402 €	402 €
68↔71	ZEP2F68-					343 €	373 €	402 €	402 €
73↔76	ZEP2F73-					343 €	373 €	402 €	402 €
76↔79	ZEP2F76-					358 €	386 €	416 €	416 €
78↔81	ZEP2F78-					358 €	386 €	416 €	416 €
83↔86	ZEP2F83-		+ 40 €	+ 40 €	+ 40 €	358 €	386 €	416 €	416 €
88↔91	ZEP2F88-					373 €	402 €	429 €	429 €
93↔96	ZEP2F93-					373 €	402 €	429 €	429 €
98↔101	ZEP2F98-					387 €	417 €	445 €	445 €
118↔121	ZEP2F118-					387 €	417 €	445 €	445 €

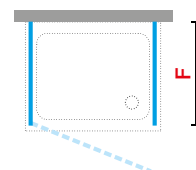
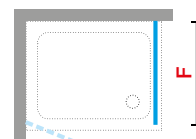
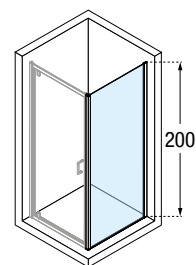

PARA LAS SOLUCIONES CON DOS PANELES FIJOS LATERALES, UTILIZAR SIEMPRE 2 BARRAS DE SUJECIÓN EN ÁNGULO
PARA AS SOLUÇÕES COM DOIS PAINÉIS FIXOS LATERAIS, UTILIZAR SEMPRE 2 BARRAS DE FIXAÇÃO EM ÂNGULO

ZEPHYROS 2.0 F SPECIAL 1

PANEL FIJO ESPECIAL
PAINEL FIXO ESPECIAL



CRISTAL TEMPLADO VIDRO TEMPERADO



Transparente
cod 1



Satinado
Fosco
cod 4



Niva
cod 11

COLORES PERFILES CORES PERFÍS



Blanco
Branco
cod. U



Silver
Abrillantado
cod. B



Cromo
cod K



Negro mate
cod H

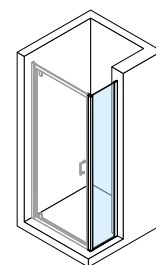

Medidas	Código	Selección Cristales Seleção Vidros			Selección de perfiles Seleção de perfis			
		1	4	11	U	B	K	H
Medidas extensibilidad Medidas extensibilidade		Transparente	Satinado Fosco	Niva	Blanco mate Branco mate	Silver Abrillantado	Cromo	Negro mate
A	ZEP2F1SP		+ 40 €	+ 40 €	451 €	507 €	561 €	561 €
H 150↕200 L 20↔118								

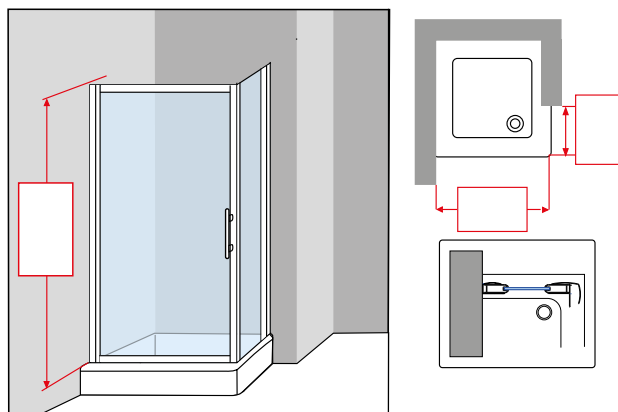

PARA MÁS OPCIONES DE PANELES FIJOS ESPECIALES, CONSULTAR LA TARIFA "ÁREA DE PROYECTOS"
PARA MAIS FIXOS ESPECIAIS, CONSULTAR A TARIFA "ÁREA DE PROYECTOS"

Construcción del código: **Código** + **Cristales Vidros** + **Perfiles Perfis** = Código completo del producto
Construção do código

ZEPHYROS 2.0 F SPECIAL 2

PANEL FIJO ESPECIAL
PAINEL FIXO ESPECIAL



6 mm



3 cm



CRISTAL TEMPLADO VIDRO TEMPERADO



Transparente
cod 1



Satinado
Fosco
cod 4



Niva
cod 11

COLORES PERFILES CORES PERFÍS



Blanco
Branco
cod. U



Silver
Abrillantado
cod. B



Cromo
cod K



Negro mate
cod H

Medidas	Código	Selección Cristales Seleção Vidros			Selección de perfiles Seleção de perfis			
		1	4	11	U	B	K	H
Medidas extensibilidad Medidas extensibilidade		Transparente	Satinado Fosco	Niva	Blanco mate Branco mate	Silver Abrillantado	Cromo	Negro mate
A								
H 155±200 L 60↔119	ZEP2F2SP	+ 40 €	+ 40 €	676 €	745 €	813 €	813 €	

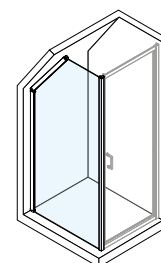

Izquierda
Esquerda

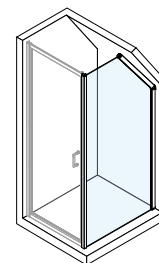

Derecha
Direita

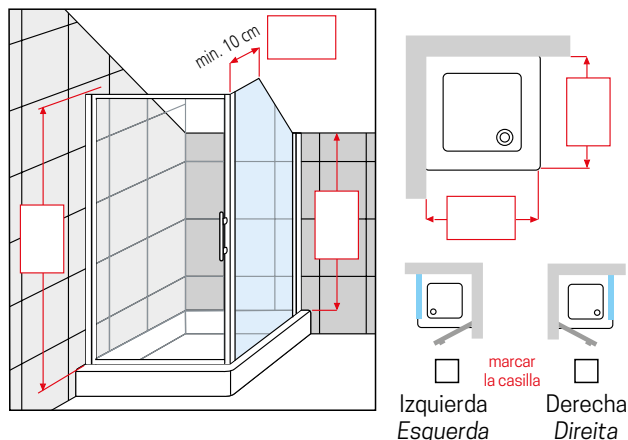

PARA MÁS OPCIONES DE PANELES FIJOS ESPECIALES, CONSULTAR LA TARIFA "AREA DE PROYECTOS"
PARA MAIS FIXOS ESPECIAIS, CONSULTAR A TARIFA "AREA DE PROYECTOS"

ZEPHYROS 2.0 F SPECIAL 3

PANEL FIJO ESPECIAL
PAINEL FIXO ESPECIAL



CRISTAL TEMPLADO VIDRO TEMPERADO



Transparente
cod 1



Satinado
Fosco
cod 4



Niva
cod 11

COLORES PERFILES CORES PERFÍS



Blanco
Branco
cod. U



Silver
Abrillantado
cod. B



Cromo
cod K



Negro mate
cod H

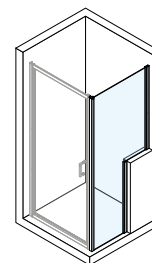

Medidas	Código	Selección Cristales Seleção Vidros			Selección de perfiles Seleção de perfis			
		1	4	11	U	B	K	H
Medidas extensibilidad Medidas extensibilidade								
A		Transparente	Satinado Fosco	Niva	Blanco mate Branco mate	Silver Abrillantado	Cromo	Negro mate
H 140±200 L 60↔99	ZEP2F3SP	+ 40 €	+ 40 €	718 €	761 €	843 €	925 €	

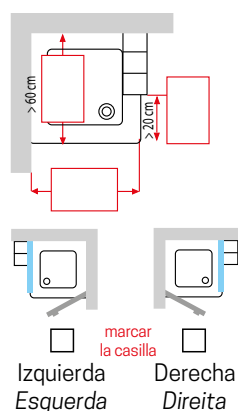
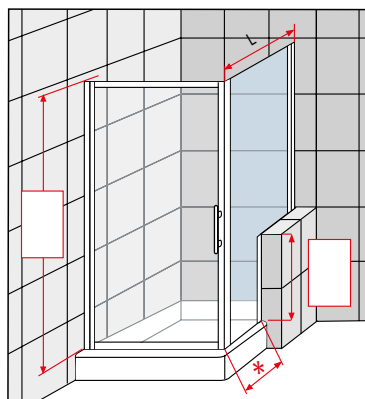

LA MEDIDA * DEBE SER SUPERIOR A 1/3 DE LA MEDIDA DE LUZ Y NO INFERIOR A 20 CM.

PARA MÁS OPCIONES DE PANELES FIJOS ESPECIALES, CONSULTAR LA TARIFA "ÁREA DE PROYECTOS"
PARA MAIS FIXOS ESPECIAIS, CONSULTAR A TARIFA "ÁREA DE PROYECTOS"

Construcción del código: **Código** + **Cristales Vidros** + **Perfiles Perfis** = Código completo del producto
Construção do código: **Código** + **Cristales Vidros** + **Perfiles Perfis** = Código completo do produto

ZEPHYROS 2.0 F SPECIAL 4



6 mm



6 cm



PANEL FIJO ESPECIAL
PAINEL FIXO ESPECIAL



CRISTAL TEMPLADO VIDRO TEMPERADO



Transparente
cod 1



Satinado
Fosco
cod 4



Niva
cod 11

COLORES PERFILES CORES PERFÍS



Blanco
Branco
cod. U



Silver
Abrillantado
cod. B



Cromo
cod K



Negro mate
cod H

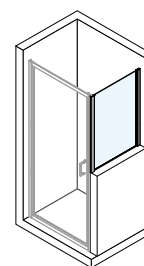

Medidas	Código	Selección Cristales Seleção Vidros			Selección de perfiles Seleção de perfis			
		1	4	11	U	B	K	H
Medidas extensibilidad Medidas extensibilidade		Transparente	Satinado Fosco	Niva	Blanco mate Branco mate	Silver Abrillantado	Cromo	Negro mate
A								
H 25↕200 L 20↔118	ZEP2F4SP	+ 40 €	+ 40 €	480 €	534 €	588 €	588 €	

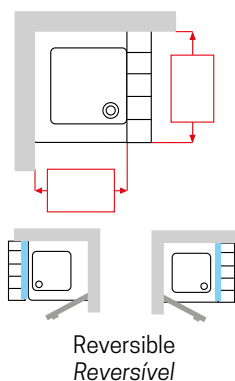
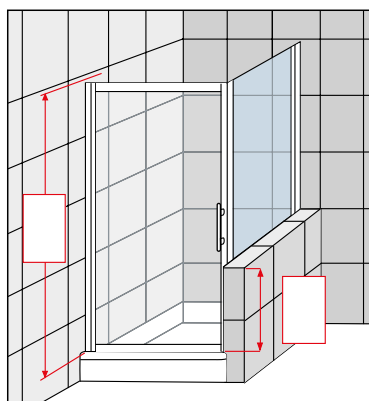

PARA MÁS OPCIONES DE PANELES FIJOS ESPECIALES, CONSULTAR LA TARIFA "AREA DE PROYECTOS"
PARA MAIS FIXOS ESPECIAIS, CONSULTAR A TARIFA "AREA DE PROYECTOS"

ZEPHYROS 2.0 F SPECIAL 5

PANELES FIJOS ESPECIALES
PAINÉLES FIXOS ESPECIAIS



6 mm



3 cm



FIJACIÓN EN LÍNEA
FIXAÇÃO EM LINHA



PAREDES DIVISORIAS



FIJACIÓN A PARED LATERAL
FIXAÇÃO A PAREDE LATERAL



EN LÍNEA SOBRE MURETE
EM LINHA SOBRE PAREDE

FIJACIÓN EN LÍNEA / FIXAÇÃO EM LINHA

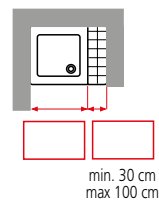
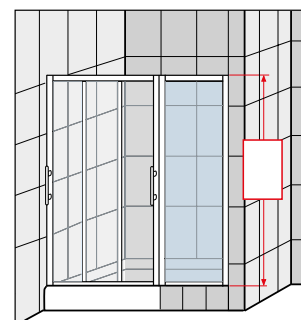

PAREDES DIVISORIAS

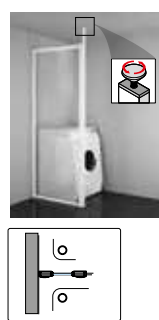
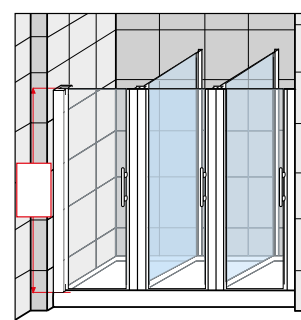

FIJO LATERAL / FIXO LATERAL

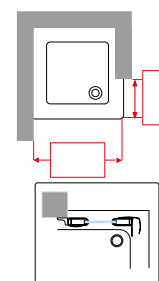
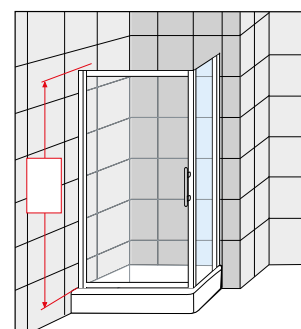

PERFIL CERRADO / PERFIL FECHADO

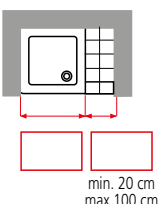
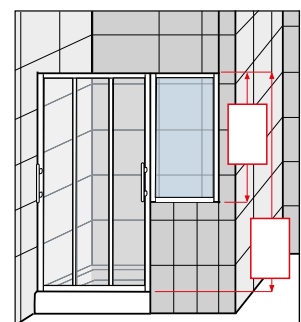

Medidas	Código	Selección Cristales Seleção Vidros			Selección de perfiles Seleção de perfis			
		1	4	11	U	B	K	H
Medidas extensibilidad Medidas extensibilidade								
A		Transparente	Satinado Fosco	Niva	Blanco mate Branco mate	Silver Abrilantado	Cromo	Negro mate

FIJACIÓN EN LÍNEA / FIXAÇÃO EM LINHA								
H 25↔60	ZEP2F5SP				480 €	555 €	630 €	630 €
H 60↔96	ZEP2F5SP				535 €	612 €	687 €	687 €
H 96↔160	ZEP2F5SP	+ 40 €	+ 40 €		578 €	654 €	728 €	728 €
H 160↔190	ZEP2F5SP				614 €	689 €	763 €	763 €
H 190↔200	ZEP2F5SP				649 €	723 €	798 €	798 €

FIJO LATERAL / FIXO LATERAL								
H 25↔60	ZEP2F5SP				514 €	588 €	665 €	665 €
H 60↔96	ZEP2F5SP				578 €	654 €	728 €	728 €
H 96↔160	ZEP2F5SP	+ 40 €	+ 40 €		614 €	689 €	763 €	763 €
H 160↔190	ZEP2F5SP				649 €	723 €	798 €	798 €
H 190↔200	ZEP2F5SP				691 €	765 €	841 €	841 €

FIJACIÓN A PARED LATERAL / FIXAÇÃO A PAREDE LATERAL								
H 25↔60	ZEP2F5SP				550 €	624 €	700 €	700 €
H 60↔96	ZEP2F5SP				614 €	689 €	763 €	763 €
H 96↔160	ZEP2F5SP	+ 40 €	+ 40 €		649 €	723 €	798 €	798 €
H 160↔190	ZEP2F5SP				691 €	765 €	841 €	841 €
H 190↔200	ZEP2F5SP				734 €	808 €	883 €	883 €

PARA MÁS OPCIONES DE PANELES FIJOS ESPECIALES, CONSULTAR LA TARIFA "ÁREA DE PROYECTOS"
PARA MAIS FIXOS ESPECIAIS, CONSULTAR A TARIFA "ÁREA DE PROYECTOS"

Construcción del código: Código + Cristales Vidros + Perfiles Perfis = Código completo del producto
Construção do código

DATOS TÉCNICOS / DADOS TÉCNICOS

COLORES PERFILES / CORES PERFÍS

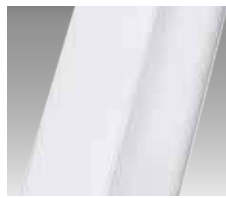

Blanco
Branco
cod. U

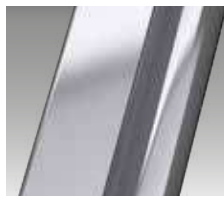

Silver
Abrillantado
cod. B



Cromo
cod. K



Negro mate
cod. H

TIRADOR / PUXADOR



Tirador
Puxador

CRISTAL / VIDRO 6 mm (European standards UNE EN 14428)



Transparente
cod. 1



Satinado
Fosco
cod. 4



Niva
cod. 11

SERIGRAFIA



Strip
cod. 91



Stripes
cod. 82
solo para modelo G - F

OPCIONAL



BARRA ESTABILIZADORA BARRA ESTABILIZADORA

Color Cores	Medidas	Código	Precio
Blanco mate Branco mate	25 cm	R80LOU250-U	76 €
Cromo		R80LOU250-K	76 €
Negro mate		R80LOU250-H	76 €
Blanco mate Branco mate	35 cm	R80LOU350-U	83 €
Cromo		R80LOU350-K	83 €
Negro mate		R80LOU350-H	83 €
Blanco mate Branco mate	45 cm	R80LOU450-U	90 €
Cromo		R80LOU450-K	90 €
Negro mate		R80LOU450-H	90 €

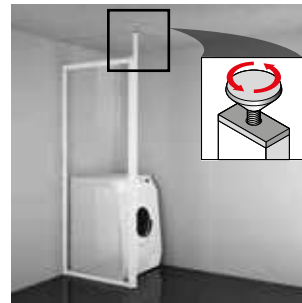

PERFIL AL TECHO PERFIL DO TELHADO

▪ Perfil especial para sujeción a techo del fijo ZEPHYRF5SP

Finitura	Misure	Codice	Prezzo
Bianco	H 180 ↓ 265	SPA3102	115 €
Silver	H 180 ↓ 265	SPA3102	128 €
Cromo	H 240	SPA31240ST-K	142 €

MEDIDAS QUE OCUPAN LOS PERFILES EN LA PARED / ESPAÇO QUE OCUPAN OS PERFÍS NA PAREDE

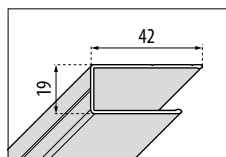

A PARED
A - R - F - AH - PH - FH

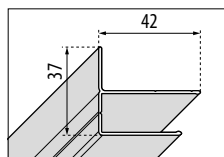

A PARED
2P - G - B - S2 - 3P - 2A

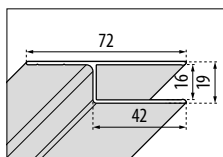

A PARED
montaje lateral en pared
todos los modelos

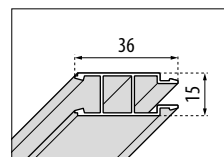

COMPENSADORES

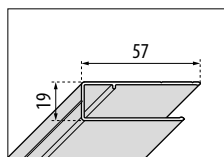

COMPENSADORES
A - R - F - AH - PH - FH

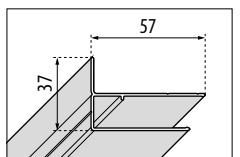

COMPENSADORES
2P - G - B - S2 - 3P - 2A

Colores perfil Cores perfil	Código
Blanco Branco	P01BHRAST2-U
Silver Silver	P01BHRAST2-B
Abrillantado Abrillantado	P01BHRAST2-K
Cromo Cromo	P01BHRAST2-K
Negro mate Negro mate	P01BHRAST2-H

Colores perfil Cores perfil	Código
Blanco Branco	P01BHMOST2-U
Silver Silver	P01BHMOST2-B
Abrillantado Abrillantado	P01BHMOST2-K
Cromo Cromo	P01BHMOST2-K
Negro mate Negro mate	P01BHMOST2-H

Colores perfil Cores perfil	Código
Blanco Branco	P01L215STL2-U
Silver Silver	P01L215STL2-B
Abrillantado Abrillantado	P01L215STL2-K
Cromo Cromo	P01L215STL2-K
Negro mate Negro mate	P01L215STL2-H

Colores perfil Cores perfil	Código
Blanco Branco	P05HAAST2-U
Silver Silver	P05HAAST2-B
Abrillantado Abrillantado	P05HAAST2-K
Cromo Cromo	P05HAAST2-K
Negro mate Negro mate	P05HAAST2-H

Colores perfil Cores perfil	Código
Blanco Branco	P05BHST2-U
Silver Silver	P05BHST2-B
Abrillantado Abrillantado	P05BHST2-K
Cromo Cromo	P05BHST2-K
Negro mate Negro mate	P05BHST2-H

Colores perfil Cores perfil	Código
Blanco Branco	P05BHCST2-U
Silver Silver	P05BHCST2-B
Abrillantado Abrillantado	P05BHCST2-K
Cromo Cromo	P05BHCST2-K
Negro mate Negro mate	P05BHCST2-H

TOMA DE MEDIDAS

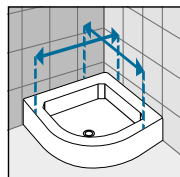
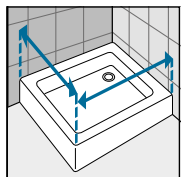

Tomar las medidas desde la pared hasta el borde externo del plato de ducha.
Medir a distância desde a parede até o rebordo externo da base de chuveiro.

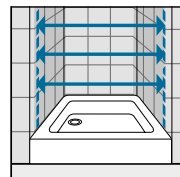

Tomar medidas de pared a pared, medir la parte baja, la central y la superior. Cursar el pedido con la medida más pequeña.
Medir a distância entre paredes, tem que tirar três medidas (inferior, superior e central) e utilizar a inferior. Encomendar pedido da medida mais pequena.





LUNES

IMAGINA CUÁNTAS
COMBINACIONES PUEDES
HACER. AÑADE UNA NUEVA.
IMAGINE QUANTAS
COMBINAÇÕES QUE VOCÊ PODE
FAZER. ADICIONAR UM NOVO.



◀
Tirador
Puxador



◀
Sistema de deslizamiento
silencioso mediante cojinetes
a esfera.
*Sistema de deslizamento
silencioso mediante
rolamentos de esfera*



◀
sistema de liberación de
puertas para una fácil
limpieza
*Sistema de liberação das
portas para uma fácil limpeza*



TRATAMIENTOS / TRATAMENTOS





LUNES

ANGULAR DE DOS PUERTAS CORREDERAS + DOS FIJOS ANGULAR DE DUAS PORTS DE CORRER + DOS FIXOS

Medidas			Código	Selección Cristales Seleção Vidros				Selección de perfiles Seleção de perfis			
Medidas extensibilidad Medidas extensibilidade	Fijo frontal Fixo frontal	Entrada		1	2	11	78	A	B	K	J
A	F1	*		Transparente	Aqua	Niva	Serigrafía Lunes 2.0	Blanco Branco	Silver Abrrilantado	Cromo	Plata Prata
66↔69	33	36	LUNA66L-					342 €	388 €	426 €	372 €
69↔72	34,5	38	LUNA69L-					342 €	388 €	426 €	372 €
72↔75	36	40	LUNA72L-					342 €	388 €	426 €	372 €
75↔78	37,5	42	LUNA75L-					342 €	388 €	426 €	372 €
78↔81	39	44	LUNA78L-					360 €	406 €	448 €	391 €
81↔84	40,5	46	LUNA81L-					360 €	406 €	448 €	391 €
84↔87	42	48	LUNA84L-					360 €	406 €	448 €	391 €
87↔90	43,5	50	LUNA87L-		+ 40 €	+ 40 €	+ 40 €	360 €	406 €	448 €	391 €
90↔93	45	53	LUNA90L-					400 €	445 €	490 €	428 €
93↔96	46,5	55	LUNA93L-					400 €	445 €	490 €	428 €
96↔99	48	57	LUNA96L-					400 €	445 €	490 €	428 €
99↔102	49,5	59	LUNA99L-					400 €	445 €	490 €	428 €
108↔111	54	65	LUNA108L-					438 €	483 €	533 €	464 €
111↔114	55,5	67	LUNA111L-					438 €	483 €	533 €	464 €
114↔117	57	69	LUNA114L-					478 €	524 €	577 €	501 €
117↔120	58,5	71	LUNA117L-					478 €	524 €	577 €	501 €
H 160↔200 L 63↔117	ESPECIAL		LUNALSP	+ 40 €	+ 40 €	-		633 €	701 €	771 €	672 €

**PARA COMPONER UN ÁNGULO PEDIR DOS LATERALES
FORMAR UM ÂNGULO PEDINDO DOIS LATERAIS**

**SE PUEDE PEDIR UN FIJO LATERAL PARA CUBRIR 3 LADOS PARA COMPONER UN ÁNGULO PEDIR 2 LATERALES
PODE-SE PEDIR UM FIXO LATERAL PARA COMPLETAR 3 LADOS FORMAR UM ÂNGULO PEDINDO DOIS LATERAIS**

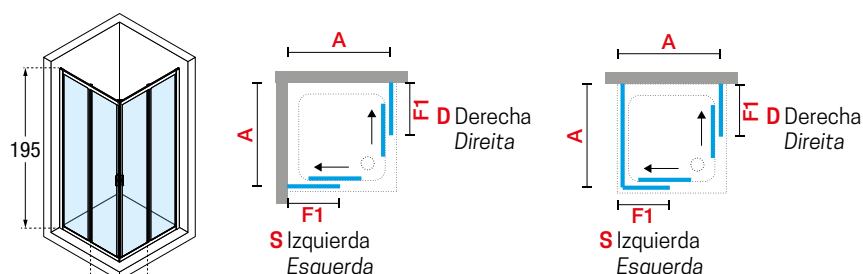

OPCIONAL

Color Cores	Código	Precio Preço
Blanco Branco	K07LUNM01-A	58 €
Gris Gris	K07LUNM01-G	58 €



CRISTAL TEMPLADO / VIDRO TEMPERADO

 Transparente
cod 1

 Aqua
cod 2

 Niva
cod 11

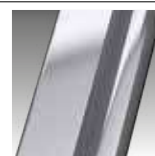
 Ser. Lunes 2.0
cod 78
COLORES PERFILES / CORES PERFÍS

 Blanco
 Branco
cod. A

 Silver
 Abbrillatado
cod. B

 Cromo
cod K

 Plata
 Prata
cod J

LUNES AH



195 cm



6 mm
puerta
porta



4 mm
fijo
fixo



3 cm



MAMPARA ANGULAR DE DOS PUERTAS CORREDAS + DOS FIJOS RESGUARDO ANGULAR DE DUAS PORTAS DE CORRER + DOS FIXOS

Medidas			Código	Derecha Direita	Izquierda Esquerda	Selección Cristales Seleção Vidros				Selección de perfiles Seleção de perfis			
Medidas extensibilidad Medidas extensibilidade	Fijo frontal Fixo frontal	Entrada		D-	S-	1	2	11	78	A	B	K	J
A	F1	*				Transpa- rente	Aqua	Niva	Serigrafia Lunes 2.0	Blanco Branco	Silver Abrillantado	Cromo	Plata Prata
66↔69	33	36	LUNAH66L	D-	S-					387 €	438 €	482 €	422 €
69↔72	34	38	LUNAH69L	D-	S-					387 €	438 €	482 €	422 €
72↔75	36	39	LUNAH72L	D-	S-					387 €	438 €	482 €	422 €
75↔78	37	41	LUNAH75L	D-	S-					387 €	438 €	482 €	422 €
78↔81	39	42	LUNAH78L	D-	S-					410 €	460 €	508 €	443 €
81↔84	40	44	LUNAH81L	D-	S-					410 €	460 €	508 €	443 €
84↔87	42	45	LUNAH84L	D-	S-					410 €	460 €	508 €	443 €
87↔90	43	47	LUNAH87L	D-	S-					410 €	460 €	508 €	443 €
90↔93	45	48	LUNAH90L	D-	S-					454 €	506 €	554 €	485 €
93↔96	46	50	LUNAH93L	D-	S-					454 €	506 €	554 €	485 €
96↔99	48	51	LUNAH96L	D-	S-					454 €	506 €	554 €	485 €
99↔102	49	53	LUNAH99L	D-	S-					454 €	506 €	554 €	485 €
102↔105	51	54	LUNAH102L	D-	S-		+ 40 €	+ 40 €	+ 40 €	496 €	548 €	602 €	525 €
105↔108	52	56	LUNAH105L	D-	S-					496 €	548 €	602 €	525 €
108↔111	54	57	LUNAH108L	D-	S-					496 €	548 €	602 €	525 €
111↔114	55	59	LUNAH111L	D-	S-					496 €	548 €	602 €	525 €
114↔117	57	60	LUNAH114L	D-	S-					540 €	591 €	651 €	569 €
117↔120	60	60	LUNAH117L	D-	S-					540 €	591 €	651 €	569 €
120↔123	63	60	LUNAH120L	D-	S-					540 €	591 €	651 €	569 €
123↔126	66	60	LUNAH123L	D-	S-					540 €	591 €	651 €	569 €
126↔129	69	60	LUNAH126L	D-	S-					598 €	650 €	714 €	625 €
129↔132	72	60	LUNAH129L	D-	S-					598 €	650 €	714 €	625 €
132↔135	75	60	LUNAH132L	D-	S-					641 €	693 €	763 €	665 €
135↔138	78	60	LUNAH135L	D-	S-					641 €	693 €	763 €	665 €
138↔141	81	60	LUNAH138L	D-	S-					687 €	737 €	810 €	708 €
H 160;200	ESPECIAL	Derecha Direita	LUNAHLDSP	-	-		+ 40 €	+ 40 €	-	716 €	793 €	872 €	761 €
		Izquierda Esquerda	LUNAHLSPP	-	-				-	716 €	793 €	872 €	761 €

PARA COMPONER UN ÁNGULO PEDIR 2 LATERALES FORMAR UM ÂNGULO PEDINDO DOIS LATERAIS

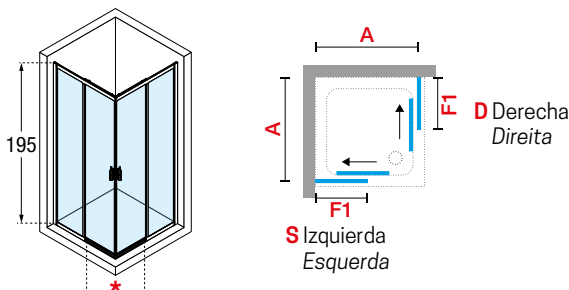

098

Construcción del código:
Construção do código

Código + **Izquierda / Derecha** + **Cristales** + **Perfiles** = Código completo del producto
Esquerda / Direita + **Vidros** + **Perfis** = Código completo do produto

CRISTAL TEMPLADO / VIDRO TEMPERADO

Transparente
cod 1



Aqua
cod 2



Niva
cod 11



Ser. Lunes 2.0
cod 78

COLORES PERFILES / CORES PERFÍS

Blanco
Branco
cod. A

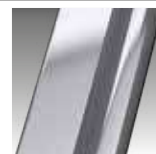

Silver
Abbrillatado
cod. B



Cromo
cod K



Plata
Prata
cod J

LUNES 2P



PUERTA DE DOS HOJAS: UNA CORREDERA + UNA FIJA

Para instalar entre paredes o con fijo lateral LUNES 2.0 FZ

RESGUARDO DE DUAS FOLHAS: UNA DE CORRER + UNA FIXA

Para instalar entre paredes ou com fixo lateral LUNES 2.0 FZ

Medidas			Código	Selección Cristales Seleção Vidros				Selección de perfiles Seleção de perfis			
Medidas extensibilidad Medidas extensibilidade	Fijo frontal Fixo frontal	Entrada		1	2	11	78	A	B	K	J
A	F1	*		Transparente	Aqua	Niva	Serigrafía Lunes 2.0	Blanco Branco	Silver Abrrillantado	Cromo	Plata Prata
96↔102	47	39	LUN2P96-					580 €	655 €	721 €	631 €
102↔108	50	42	LUN2P102-					580 €	655 €	721 €	631 €
108↔114	53	45	LUN2P108-					642 €	718 €	789 €	691 €
114↔120	56	48	LUN2P114-					642 €	718 €	789 €	691 €
120↔126	59	51	LUN2P120-					706 €	780 €	860 €	750 €
126↔132	62	54	LUN2P126-		+ 40 €	+ 40 €	+ 40 €	706 €	780 €	860 €	750 €
132↔138	65	57	LUN2P132-					774 €	844 €	929 €	812 €
138↔144	68	60	LUN2P138-					774 €	844 €	929 €	812 €
144↔150	71	63	LUN2P144-					841 €	911 €	1.003 €	876 €
150↔156	74	66	LUN2P150-					841 €	911 €	1.003 €	876 €
156↔162	77	69	LUN2P156-					841 €	911 €	1.003 €	876 €
H 160±200	ESPECIAL		LUN2PSP	+ 40 €	+ 40 €	-		1.076 €	1.168 €	1.285 €	1.121 €

OPCIONAL



KIT DE 2 RODAMIENTOS EXTRAÍBLES LUNES 2.0 2P
KIT DE 2 ROLAMENTOS EXTRAÍVEIS LUNES 2.0 2P

Color Cores	Código	Precio Preço
Blanco Branco	K07LUN2P1-A	37 €
Gris Gris	K07LUN2P1-G	37 €

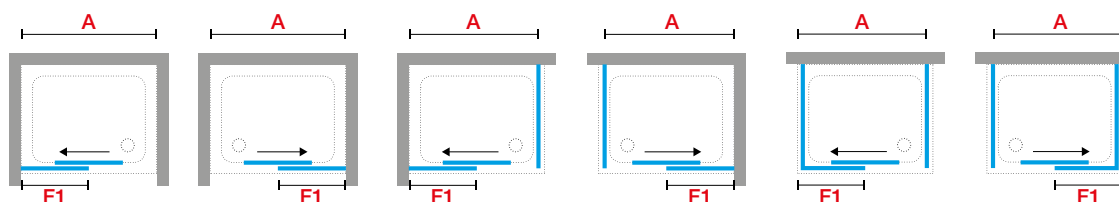
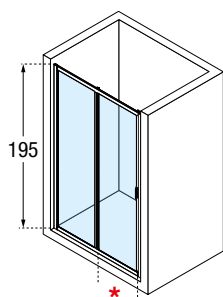

100



Construcción del código:
Construção do código

Código

+ Cristales
Vidros

+ Perfiles
Perfis

= Código completo del producto
Código completo do produto



CRISTAL TEMPLADO / VIDRO TEMPERADO

 Transparente
cod 1

 Aqua
cod 2

 Niva
cod 11

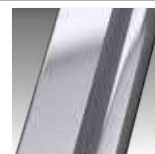
 Ser. Lunes 2.0
cod 78
COLORES PERFILES / CORES PERFÍS

 Blanco
 Branco
cod. A

 Silver
 Abrrillantado
cod. B

 Cromo
cod K

 Plata
 Prata
cod J

LUNES 2PH



MAMPARA DE 2 HOJAS: 1 CORREDERA + 1 FIJA

Para instalar entre paredes o con fijo lateral LUNES 2.0 FZ

RESGUARDO DE 2 FOLHAS: 1 DE CORRER + 1 FIXA

Para instalar entre paredes ou com fijo lateral LUNES 2.0 FZ

Medidas			Código	Derecha	Izquierda	Selección Cristales Seleção Vidros				Selección de perfiles Seleção de perfis			
Medidas extensibilidad	Fijo frontal	Entrada		Dereita	Esquerda	1	2	11	78	A	B	K	J
Medidas extensibilidad	Medidas extensibilidad	Medidas extensibilidad		D-	S-	Transparente	Aqua	Niva	Serigrafia Lunex 2.0	Blanco Branco	Silver Abrrilantado	Cromo	Plata Prata
A	F1	*											
96↔102	46	38	LUN2PH96	D-	S-					676 €	766 €	843 €	736 €
102↔108	49	41	LUN2PH102	D-	S-					676 €	766 €	843 €	736 €
108↔114	52	44	LUN2PH108	D-	S-					752 €	840 €	924 €	808 €
114↔120	55	47	LUN2PH114	D-	S-					752 €	840 €	924 €	808 €
120↔126	58	50	LUN2PH120	D-	S-					825 €	912 €	1.005 €	877 €
126↔132	61	53	LUN2PH126	D-	S-					825 €	912 €	1.005 €	877 €
132↔138	64	56	LUN2PH132	D-	S-					904 €	986 €	1.085 €	949 €
138↔144	67	59	LUN2PH138	D-	S-					904 €	986 €	1.085 €	949 €
144↔150	70	62	LUN2PH144	D-	S-					983 €	1.064 €	1.171 €	1.023 €
150↔156	76	62	LUN2PH150	D-	S-					983 €	1.064 €	1.171 €	1.023 €
156↔162	82	62	LUN2PH156	D-	S-					983 €	1.064 €	1.171 €	1.023 €
162↔168	85	65	LUN2PH162	D-	S-					1.060 €	1.145 €	1.260 €	1.101 €
168↔174	91	65	LUN2PH168	D-	S-					1.060 €	1.145 €	1.260 €	1.101 €
174↔180	97	65	LUN2PH174	D-	S-					1.060 €	1.145 €	1.260 €	1.101 €
H 160†200	ESPE- CIAL		LUN2PHDSP	-	-					1.256 €	1.364 €	1.500 €	1.309 €
			LUN2PHSSP	-	-					1.256 €	1.364 €	1.500 €	1.309 €

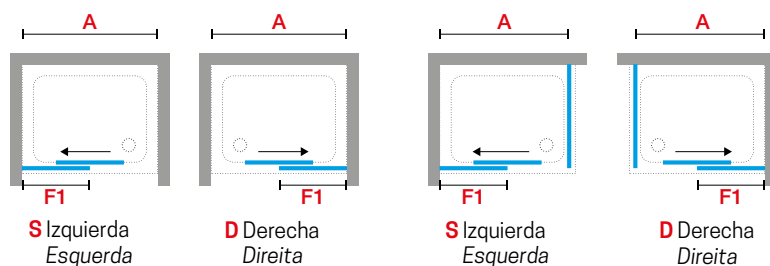
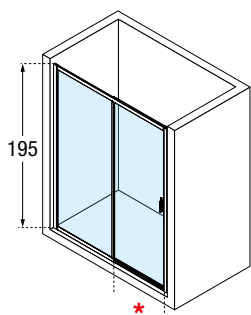



CRISTAL TEMPLADO / VIDRO TEMPERADO

 Transparente
cod 1

 Aqua
cod 2

 Niva
cod 11

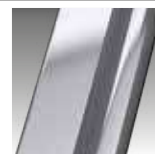
 Ser. Lunes 2.0
cod 78
COLORES PERFILES / CORES PERFÍS

 Blanco
 Branco
cod. A

 Silver
 Abrrillatado
cod. B

 Cromo
cod K

 Plata
 Prata
cod J

LUNES G



MAMPARA DE DUCHA ABATIBLE DE UNA HOJA, APERTURA IN OUT

Para instalar entre paredes o con fijo lateral LUNES 2.0 FZ

RESGUARDO DE DUCHE DE ABRIR DE UMA FOLHA, APERTURA IN OUT

Para instalar entre paredes ou com fixo lateral LUNES 2.0 FZ

Medidas			Código	Selección Cristales Seleção Vidros				Selección de perfiles Seleção de perfis			
Medidas extensibilidad Medidas extensibilidade	Entrada	Espacio de apertura Espaço de abertura		1	2	11	78	A	B	K	J
A	*	B		Transparente	Aqua	Niva	Serigrafía Lunes 2.0	Blanco Branco	Silver Abrillatado	Cromo	Plata Prata
60↔66	41	40	LUNG60-					459 €	507 €	555 €	487 €
66↔72	47	46	LUNG66-					459 €	507 €	555 €	487 €
72↔78	53	52	LUNG72-					459 €	507 €	555 €	487 €
78↔84	56	55	LUNG78-		+ 40 €	+ 40 €	+ 40 €	493 €	540 €	594 €	519 €
84↔90	62	61	LUNG84-					493 €	540 €	594 €	519 €
90↔96	68	67	LUNG90-					529 €	577 €	635 €	554 €
96↔102	74	73	LUNG96-					529 €	577 €	635 €	554 €
H 160†200		ESPECIAL	LUNGSP		+ 40 €	+ 40 €	-	672 €	746 €	822 €	718 €

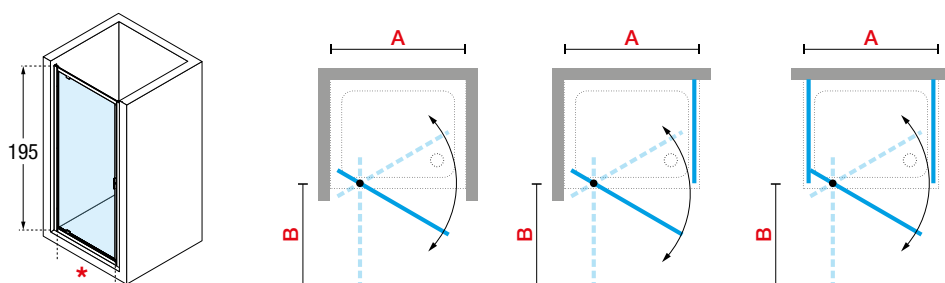



CRISTAL TEMPLADO / VIDRO TEMPERADO

 Transparente
cod 1

 Aqua
cod 2

 Niva
cod 11

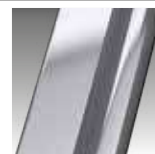
 Ser. Lunes 2.0
cod 78
COLORES PERFILES / CORES PERFÍS

 Blanco
 Branco
cod. A

 Silver
 Abrrillantado
cod. B

 Cromo
cod K

 Plata
 Prata
cod J

LUNES B



195 cm



5 mm



6 cm



MAMPARA DE DUCHA DE DOS HOJAS ABATIBLES Para instalar entre paredes o con fijo lateral LUNES 2.0 FZ

RESGUARDO DE DUCHE DE DUAS FOLHAS ABATIVEIS Para instalar entre paredes ou com fixo lateral LUNES 2.0 FZ



CRISTAL TEMPLADO VIDRO TEMPERADO



Transparente
cod 1



Aqua
cod 2



Niva
cod 11



Ser. Lunes 2.0
cod 78

COLORES PERFILES CORES PERFÍS



Blanco
Branco
cod. A

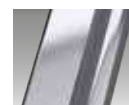

Silver
Abrillantado
cod. B



Cromo
cod K



Plata
Prata
cod J

Medidas			Código	Selección Cristales Seleção Vidros				Selección de perfiles Seleção de perfis			
Medidas extensibilidad Medidas extensibilidade	Entrada	Espacio de apertura Espaço de abertura		1	2	11	78	A	B	K	J
A	*	B		Transparente	Aqua	Niva	Serigrafia LUNES 2.0	Blanco Branco	Silver Brillantado	Cromo	Plata Prata
60↔66	40	19	LUNB60-					548 €	616 €	678 €	593 €
66↔72	46	22	LUNB66-					548 €	616 €	678 €	593 €
72↔78	52	25	LUNB72-					548 €	616 €	678 €	593 €
78↔84	50	24	LUNB78-					605 €	672 €	739 €	647 €
84↔90	56	27	LUNB84-					605 €	672 €	739 €	647 €
90↔96	62	30	LUNB90-		+ 40 €	+ 40 €	+ 40 €	605 €	672 €	739 €	647 €
96↔102	62	30	LUNB96-					668 €	734 €	807 €	706 €
102↔108	68	33	LUNB102-					668 €	734 €	807 €	706 €
108↔114	74	36	LUNB108-					668 €	734 €	807 €	706 €
114↔120	80	39	LUNB114-					668 €	734 €	807 €	706 €
H 158↔200		ESPECIAL	LUNBSP		+ 40 €	+ 40 €	-	748 €	844 €	929 €	812 €

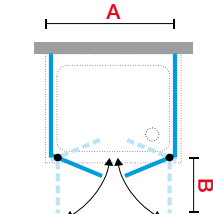
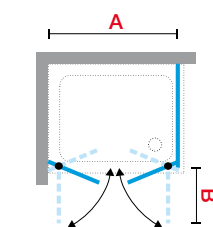
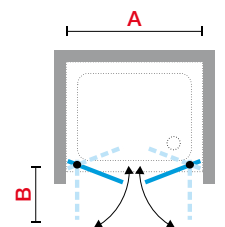
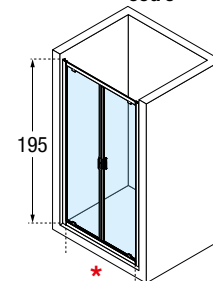

LUNES S



195 cm



4 mm



6 cm



6 cm



6 cm

MAMPARA PLEGABLE DE DOS HOJAS Para instalar entre paredes o con fijo lateral LUNES 2.0 FZ

RESGUARDO DESDOBRÁVEL DE DUAS FOLHAS Para instalar entre paredes ou com fixo lateral LUNES 2.0 FZ



CRISTAL TEMPLADO VIDRO TEMPERADO



Transparente
cod 1



Aqua
cod 2



Niva
cod 11



Ser. Lunes 2.0
cod 78

COLORES PERFILES CORES PERFIS



Blanco
Branco
cod. A



Silver
Abrilantado
cod. B



Cromo
cod K



Plata
Prata
cod J

Medidas				Código	Selección Cristales Seleção Vidros				Selección de perfiles Seleção de perfis			
Medidas extensibilidad Medidas extensibilidade	Entrada	Espacio de apertura Espaço de abertura			1	2	11	78	A	B	K	J
A	*	B	B1		Transpa- rente	Aqua	Niva	Serigrafia Lunes 2.0	Blanco Branco	Silver Abrilantado	Cromo	Plata Prata
60↔66	42	26	24	LUNS60-					623 €	704 €	704 €	677 €
66↔72	48	29	27	LUNS66-					623 €	704 €	704 €	677 €
72↔78	54	32	30	LUNS72-					623 €	704 €	704 €	677 €
78↔84	60	35	33	LUNS78-		+ 40 €	+ 40 €	+ 40 €	677 €	760 €	760 €	729 €
84↔90	66	38	36	LUNS84-					677 €	760 €	760 €	729 €
90↔96	72	41	39	LUNS90-					731 €	812 €	812 €	781 €
96↔102	78	44	42	LUNS96-					731 €	812 €	812 €	781 €
H 160↔200		ESPECIAL		LUNSSP		+ 40 €	+ 40 €	-	832 €	929 €	929 €	893 €

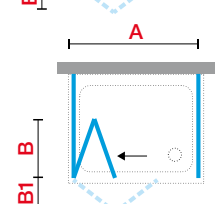
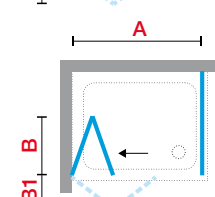
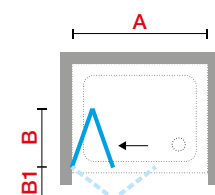
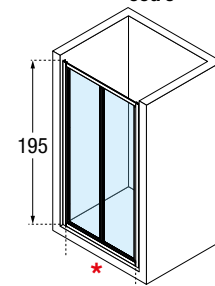

**APERTURA DE SEGURIDAD: LA APERTURA HACIA EL EXTERIOR SE CONSIDERA SÓLO COMO APERTURA DE EMERGENCIA.
ABERTURA DE SEGURANÇA: ABERTURA PARA O EXTERIOR É CONSIDERADA ÚNICA ABERTURA DE EMERGENCIA.**

Construcción del código:
Construção do código

Código

+

Cristales
Vidros

+

Perfiles
Perfis

=

Código completo del producto
Código completo do produto

LUNES 3P



195 cm



4 mm



6 cm



MAMPARA DE TRES HOJAS CORREDERAS Para instalar entre paredes o con fijo lateral LUNES 2.0 FZ

RESGUARDO DE TRES FOLHAS DE CORRER Para instalar entre paredes ou com fixo lateral LUNES 2.0 FZ

Medidas		Código	Selección Cristales Seleção Vidros				Selección de perfiles Seleção de perfis			
Medidas extensibilidad Medidas extensibilidade	Entrada		1	2	11	78	A	B	K	J
A	*		Transparente	Aqua	Niva	Serigrafía Lunes 2.0	Blanco Branco	Silver Abrillantado	Cromo	Plata Prata
78↔84	37	LUN3P78-					632 €	719 €	791 €	690 €
84↔90	41	LUN3P84-					699 €	785 €	865 €	754 €
90↔96	45	LUN3P90-					699 €	785 €	865 €	754 €
96↔102	49	LUN3P96-					699 €	785 €	865 €	754 €
102↔108	53	LUN3P102-					766 €	852 €	937 €	820 €
108↔114	57	LUN3P108-		+ 40 €	+ 40 €	+ 40 €	766 €	852 €	937 €	820 €
114↔120	61	LUN3P114-					766 €	852 €	937 €	820 €
120↔126	65	LUN3P120-					840 €	919 €	1.012 €	883 €
126↔132	69	LUN3P126-					840 €	919 €	1.012 €	883 €
132↔138	73	LUN3P132-					840 €	919 €	1.012 €	883 €
138↔144	77	LUN3P138-					840 €	919 €	1.012 €	883 €
H 160↔200	ESPECIAL	LUN3PSP		+ 40 €	+ 40 €	-	987 €	1.108 €	1.217 €	1.064 €

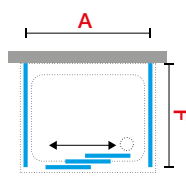
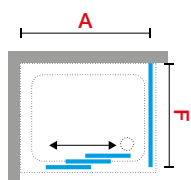
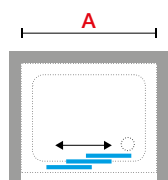
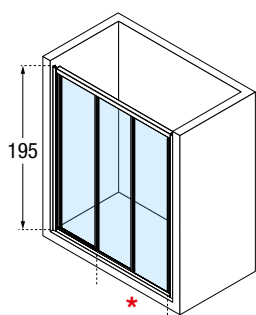

CRISTAL TEMPLADO / VIDRO TEMPERADO

Transparente
cod 1



Aqua
cod 2



Niva
cod 11



Ser. Lunes 2.0
cod 78

COLORES PERFILES / CORES PERFÍS

Blanco
Branco
cod. A

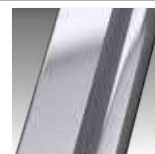

Silver
Abrillantado
cod. B



Cromo
cod K



Plata
Prata
cod J

LUNES 3PH



MAMPARA DE TRES HOJAS, 2 CORREDERAS + 1 FIJA
Para instalar entre paredes o con fijo lateral LUNES 2.0 FZ

RESGUARDO DE TRES FOLHAS, 2 CORRER + 1 FIXA
Para instalar entre paredes ou com fijo lateral LUNES 2.0 FZ



CRISTAL TEMPLADO VIDRO TEMPERADO



COLORES PERFILES CORES PERFÍS



Medidas			Código	Derecha Direita	Izquierda Esquerda	Selección Cristales Seleção Vidros				Selección de perfiles Seleção de perfis			
Medidas extensibilidad	Medidas	Entrada				1	2	11	78	A	B	K	J
A	F1	*				Transparente	Aqua	Niva	Serigrafía Lunes 2.0	Blanco Branco	Silver Abrillan- tado	Cromo	Plata Prata
78↔84	26,5	39	LUN3PH78	D-	S-					710€	809€	890€	755€
84↔90	28,5	43	LUN3PH84	D-	S-					787€	885€	973€	824€
90↔96	30,5	47	LUN3PH90	D-	S-					787€	885€	973€	824€
96↔102	32,5	51	LUN3PH96	D-	S-					787€	885€	973€	824€
102↔108	34,5	55	LUN3PH102	D-	S-					862€	959€	1.055€	895€
108↔114	36,5	59	LUN3PH108	D-	S-		+ 40 €	+ 40 €	+ 40 €	862€	959€	1.055€	895€
114↔120	38,5	63	LUN3PH114	D-	S-					862€	959€	1.055€	895€
120↔126	40,5	67	LUN3PH120	D-	S-					946€	1.036€	1.138€	964€
126↔132	42,5	71	LUN3PH126	D-	S-					946€	1.036€	1.138€	964€
132↔138	44,5	75	LUN3PH132	D-	S-					946€	1.036€	1.138€	964€
138↔144	46,5	79	LUN3PH138	D-	S-					946€	1.036€	1.138€	964€
H 160↑200	ESPECIAL		LUN3PHDSP	D	-				-	1.095 €	1.227 €	1.349 €	1.145 €
			LUN3PHSSP	S	-		+ 40 €	+ 40 €	-	1.095 €	1.227 €	1.349 €	1.145 €

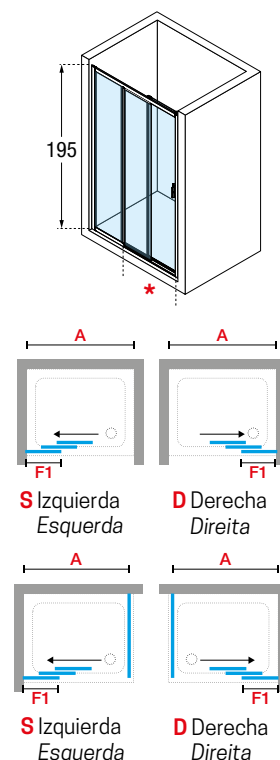

LUNES 2A



195 cm



4 mm



6 cm



FRONTAL DE DOS HOJAS CORREDERAS + DOS FIJOS

Para instalar entre paredes o con fijo lateral LUNES 2.0 FZ

RESGUARDO DE DUAS FOLHAS DE CORRER + DOS FIXOS

Para instalar entre paredes ou com fixo lateral LUNES 2.0 FZ



CRISTAL TEMPLADO VIDRO TEMPERADO



Transparente
cod 1



Aqua
cod 2



Niva
cod 11



Ser. Lunes 2.0
cod 78

COLORES PERFILES CORES PERFIS



Blanco
Branco
cod. A



Silver
Abrillantado
cod. B



Cromo
cod K



Plata
Prata
cod J

Medidas			Código	Selección Cristales Seleção Vidros				Selección de perfiles Seleção de perfis			
Medidas extensibilidad Medidas extensibilidade	Fijo frontal Fijo frontal	Entrada		1	2	11	78	A	B	K	J
A	F1	*		Transpa- rente	Aqua	Niva	Serigrafia Lunes 2.0	Blanco Branco	Silver Abrillantado	Cromo	Plata Prata
116↔122	31,5	48	LUN2A116-					933 €	1.049 €	1.154 €	1.009 €
122↔128	33	51	LUN2A122-					933 €	1.049 €	1.154 €	1.009 €
128↔134	34,5	54	LUN2A128-					933 €	1.049 €	1.154 €	1.009 €
134↔140	36	57	LUN2A134-					933 €	1.049 €	1.154 €	1.009 €
140↔146	37,5	60	LUN2A140-					1.006 €	1.123 €	1.190 €	1.076 €
146↔152	39	63	LUN2A146-	+ 80 €	+ 80 €	+ 80 €		1.006 €	1.123 €	1.190 €	1.076 €
152↔158	40,5	66	LUN2A152-					1.006 €	1.123 €	1.190 €	1.076 €
158↔164	42	69	LUN2A158-					1.006 €	1.123 €	1.190 €	1.076 €
164↔170	43,5	72	LUN2A164-					1.078 €	1.195 €	1.314 €	1.147 €
170↔176	45	75	LUN2A170-					1.078 €	1.195 €	1.314 €	1.147 €
176↔182	46,5	78	LUN2A176-					1.078 €	1.195 €	1.314 €	1.147 €

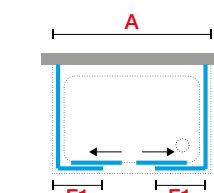
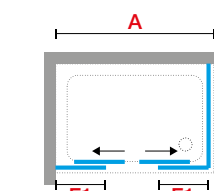
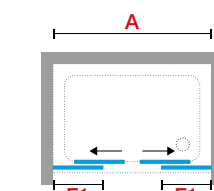
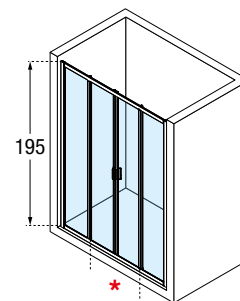

OPCIONAL



KIT DE 2 RODAMIENTOS EXTRAÍBLES LUNES 2.0 A-2A
KIT DE 2 ROLAMENTOS EXTRAÍVEIS LUNES 2.0 A-2A

Color Cores	Código	Precio Preço
Blanco Branco	K07LUNM01-A	58 €
Gris Gris	K07LUNM01-G	58 €

Construcción del código:
Construção do código

Código

+

Cristales
Vidros

+

Perfiles
Perfis

=

Código completo del producto
Código completo do produto

LUNES G+F EN LÍNEA/EM LINHA



195 cm



5 mm
puerta
porta



4 mm



6 cm



MAMPARA DE UNA HOJA ABATIBLE Y UNA FIJA EN LÍNEA

Para instalar entre paredes o con fijo lateral LUNES 2.0 FZ

RESGUARDO COMPOSTO POR UMA PORTA ABATÍVEL E FIXO EM LINHA

Para instalar entre paredes ou com fijo lateral LUNES 2.0 FZ



CRISTAL TEMPLADO VIDRO TEMPERADO



Transparente
cod 1



Aqua
cod 2



Niva
cod 11



Ser. Lunes 2.0
cod 78

COLORES PERFILES CORES PERFÍS



Blanco
Branco
cod. A



Silver
Abrillantado
cod. B



Cromo
cod K



Plata
Prata
cod J

Medidas				Código	Selección Cristales Seleção Vidros				Selección de perfiles Seleção de perfis			
Medidas extensibilidad Medidas extensibilidade	Fijo frontal Fixo frontal	Entrada	Espacio de apertura Espaço de abertura		1	2	11	78	A	B	K	J
A	F1	*	B		Transpa- rente	Aqua	Niva	Serigrafía Lunes 2.0	Blanco Branco	Silver Abrillantado	Cromo	Plata Prata
96↔102	34	41	46	LUNGF96-					753 €	845 €	928 €	810 €
102↔108	34	53	52	LUNGF102-					753 €	845 €	928 €	810 €
108↔114	34	56	55	LUNGF108-					753 €	845 €	928 €	810 €
114↔120	46	53	52	LUNGF114-					830 €	920 €	1.014 €	885 €
120↔126	46	56	55	LUNGF120-	+ 40 €	+ 40 €	+ 40 €		830 €	920 €	1.014 €	885 €
126↔132	46	62	61	LUNGF126-					830 €	920 €	1.014 €	885 €
132↔138	58	56	55	LUNGF132-					906 €	1.007 €	1.107 €	969 €
138↔144	58	62	61	LUNGF138-					906 €	1.007 €	1.107 €	969 €
144↔150	58	68	67	LUNGF144-					906 €	1.007 €	1.107 €	969 €

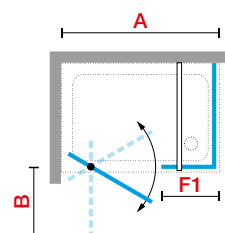
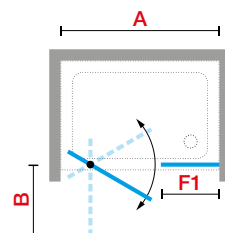
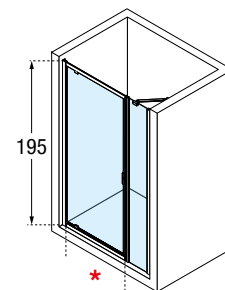

OPCIONAL



BARRA DE SUJECIÓN 150 CM

pedir en el caso de instalar con fijo lateral

Color/Cores	Código	Precio / Preço
Blanco/Branco	R80SMAH15-A	110 €
Silver/Abrillantado	R80SMAH15-B	124 €
Cromo	R80SMAH15-K	137 €
Plata/Prata	R80SMAH15-J	116 €

LUNES R



195 cm



4 mm



3 cm



MAMPARA SEMICIRCULAR DE DOS PUERTAS CORREDERAS + DOS FIJOS
RESGUARDO PARA BASE SEMICIRCULAR COMPUESTO POR DUAS PORTAS DE CORRER



CRISTAL TEMPLADO VIDRO TEMPERADO



Transparente
cod 1



Aqua
cod 2



Niva
cod 11



Ser. Lunes 2.0
cod 78

COLORES PERFILES CORES PERFIS



Blanco
Branco
cod. A



Silver
Abrillantado
cod. B



Cromo
cod K



Plata
Prata
cod J

Medidas				Código	Selección Cristales Seleção Vidros				Selección de perfiles Seleção de perfis				
Medidas extensibilidad Medidas extensibilidade	Fijo frontal Fijo frontal	Entrada			1	2	11	78	A	B	K	J	
A	F1 F2	*	R		Transparente	Aqua	Niva	Serigrafía Lunes 2.0	Blanco Branco	Silver Abrillantado	Cromo	Plata Prata	
VERSIÓN SIMÉTRICA				VERSÃO SIMÉTRICA									
72↔75	33 -	41	40	LUNR75-					1.097 €	1.227 €	1.349 €	1.179 €	
77↔80	23 -	40	55	LUNR80-	+ 80 €	+ 80 €	+ 80 €		1.097 €	1.227 €	1.349 €	1.179 €	
87↔90	33 -	56	55	LUNR90-					1.097 €	1.227 €	1.349 €	1.179 €	
97↔100	43 -	56	55	LUNR100-					1.097 €	1.227 €	1.349 €	1.179 €	
VERSIÓN ASIMÉTRICA				VERSÃO ASSIMÉTRICA									
72↔75 x 87↔90	22 42	46	45,8	LUNR7590-					1.097 €	1.227 €	1.349 €	1.179 €	
77↔80 x 87↔90	23 33	48	55	LUNR8090-					1.097 €	1.227 €	1.349 €	1.179 €	
77↔80 x 97↔100	23 43	48	55	LUNR80100-					1.097 €	1.227 €	1.349 €	1.179 €	
77↔80 x 117↔120	23 63	48	55	LUNR80120-	+ 80 €	+ 80 €	+ 80 €		1.097 €	1.227 €	1.349 €	1.179 €	
87↔90 x 117↔120	33 63	56	55	LUNR90120-					1.097 €	1.227 €	1.349 €	1.179 €	
* 67↔70 x 87↔90	30 50	40	38	LUNR7090W-					1.097 €	1.227 €	1.349 €	1.179 €	
* 77↔80 x 97↔100	40 60	40	38	LUNR80100W-					1.097 €	1.227 €	1.349 €	1.179 €	
* 77↔80 x 117↔120	40 80	40	38	LUNR80120W-					1.097 €	1.227 €	1.349 €	1.179 €	

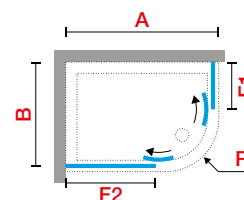
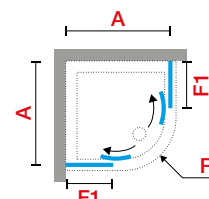
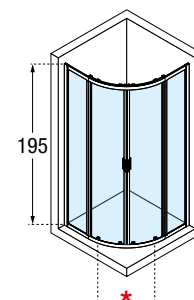

OPCIONAL

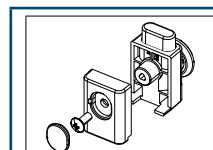

KIT DE 4 RODAMIENTOS EXTRAIBLES LUNES 2.0 R
 KIT DE 4 ROLAMENTOS EXTRAÍVEIS LUNES 2.0 R

Color / Cores	Código	Precio / Preço
Blanco / Branco	K07LUNR01-A	79 €
Gris / Gris	K07LUNR01-G	79 €

*** PARA PLATO DE DUCHA SWIM
 PARA BASE DE CHUVEIRO SWIM**

Construcción del código:
 Construção do código

Código + **Cristales Vidros** + **Perfiles Perfis** = Código completo del producto
 Código completo do produto

LUNES PENTAGONO G

MAMPARA PENTAGONAL DE UNA PUERTA GIRATORIA
TRANSPORTE PENTAGONAL DE UMA PORTA GIRATÓRIA



195 cm



5 mm
puerta
porta



4 mm
fijo
fixo



3 cm



CRISTAL TEMPLADO VIDRO TEMPERADO



Transparente
cod 1



Aqua
cod 2



Niva
cod 11



Ser. Lunes 2.0
cod 78

COLORES PERFILES CORES PERFÍS



Blanco
Branco
cod. A



Silver
Abrillantado
cod. B



Cromo
cod K



Plata
Prata
cod J

Medidas					Código	Selección Cristales Seleção Vidros				Selección de perfiles Seleção de perfis			
Medidas extensibilidad Medidas extensibilidade	Fijo frontal Fijo frontal	Entrada				1	2	11	78	A	B	K	J
A	F1 F2	*	B			Transparente	Aqua	Niva	Serigrafía Lunes 2.0	Blanco Branco	Silver Brillantado	Cromo	Plata Prata
88,5↔91,5	40 40	47	46	LUNPG90-						1.012 €	1.131 €	1.246 €	1.087 €
98,5↔101,5	50 50	47	46	LUNPG100-						1.012 €	1.131 €	1.246 €	1.087 €
88,5↔91,5 x 118,5↔121,5	70 40	47	46	LUNPG120-		+ 40 €	+ 40 €	+ 40 €		1.163 €	1.277 €	1.408 €	1.229 €
88,5↔91,5 x 138,5↔141,5	90 40	47	46	LUNPG140-						1.163 €	1.277 €	1.408 €	1.229 €

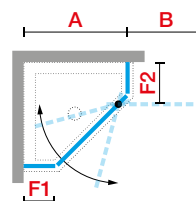
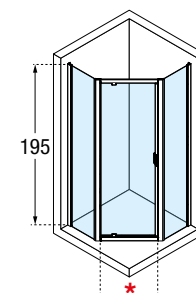

LUNES F

PANEL FIJO
PAINEL FIXO



195 cm



4 mm



6 cm



CRISTAL TEMPLADO VIDRO TEMPERADO



Transparente
cod 1



Aqua
cod 2



Niva
cod 11



Ser. Lunes 2.0
cod 78

COLORES PERFILES CORES PERFIS



Blanco
Branco
cod. A



Silver
Abrillantado
cod. B



Cromo
cod K



Plata
Prata
cod J

Medidas	Código	Selección Cristales Seleção Vidros				Selección de perfiles Seleção de perfis			
		1	2	11	78	A	B	K	J
Medidas extensibilidad Medidas extensibilidade									
F		Transparente	Aqua	Niva	Serigrafía Lunes 2.0	Blanco Branco	Silver Abrillantado	Cromo	Plata Prata
66↔72	LUNF66-					302 €	341 €	377 €	330 €
72↔78	LUNF72-					302 €	341 €	377 €	330 €
78↔84	LUNF78-					302 €	341 €	377 €	330 €
84↔90	LUNF84-		+ 40 €	+ 40 €	+ 40 €	341 €	382 €	420 €	367 €
90↔96	LUNF90-					341 €	382 €	420 €	367 €
96↔102	LUNF96-					369 €	407 €	449 €	392 €

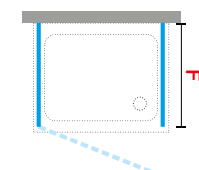
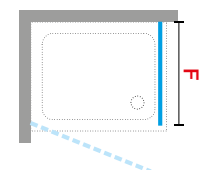
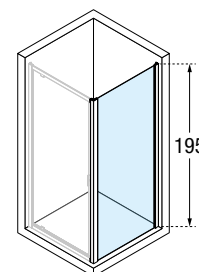

PARA LAS SOLUCIONES CON DOS PANELES FIJOS LATERALES, UTILIZAR SIEMPRE 2 BARRAS DE SUJECIÓN EN ÁNGULO
PARA AS SOLUÇÕES COM DOIS PAINÉIS FIXOS LATERAIS, UTILIZAR SEMPRE 2 BARRAS DE FIXAÇÃO EM ÂNGULO

Construcción del código:
Construção do código

Código

+

Cristales
Vidros

+

Perfiles
Perfis

=

Código completo del producto
Código completo do produto

LUNES FZ

PANEL FIJO
PAINEL FIXO



195 cm



6 mm



3 cm



CRISTAL TEMPLADO VIDRO TEMPERADO



Transparente
cod 1



Aqua
cod 2



Niva
cod 11



Ser. Lunes 2.0
cod 78

COLORES PERFILES CORES PERFÍS



Blanco
Branco
cod. A



Silver
Abrillantado
cod. B



Cromo
cod K



Plata
Prata
cod J

Medidas	Código	Selección Cristales Seleção Vidros				Selección de perfiles Seleção de perfis			
		1	2	11	78	A	B	K	J
Medidas extensibilidad Medidas extensibilidade									
F		Transparente	Aqua	Niva	Serigrafía Lunes 2.0	Blanco Branco	Silver Abrillantado	Cromo	Plata Prata
68↔71	LUNFZ68-					308 €	335 €	360 €	321 €
73↔76	LUNFZ73-					308 €	335 €	360 €	321 €
78↔81	LUNFZ78-					321 €	347 €	373 €	335 €
83↔86	LUNFZ83-		+ 40 €	+ 40 €	+ 40 €	321 €	347 €	373 €	335 €
88↔91	LUNFZ88-					335 €	360 €	386 €	349 €
93↔96	LUNFZ93-					335 €	360 €	386 €	349 €
98↔101	LUNFZ98-					348 €	374 €	401 €	363 €
H 160†200 L 23↔118 SPECIAL	LUNFZSP		+ 40 €	+ 40 €	-	405 €	455 €	504 €	422 €

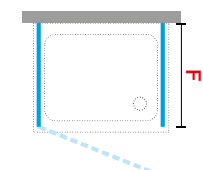
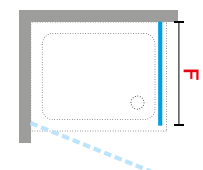
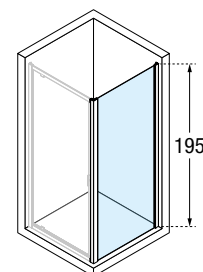

PARA LAS SOLUCIONES CON DOS PANELES FIJOS LATERALES, UTILIZAR SIEMPRE 2 BARRAS DE SUJECIÓN EN ÁNGULO
PARA AS SOLUÇÕES COM DOIS PAINÉIS FIXOS LATERAIS, UTILIZAR SEMPRE 2 BARRAS DE FIXAÇÃO EM ÂNGULO



LUNES F (SÓLO PERFILES)



195 cm



COLORES PERFILES CORES PERFÍS



Blanco
Branco
cod. A



Silver
Abrillantado
cod. B



Cromo
cod K



Plata
Prata
cod J

Medidas	Código	Selección de perfiles Seleção de perfis			
		A Blanco Branco	B Silver Abrillantado	K Cromo	J Plata Prata
FIJACIÓN A PARED FRONTAL / FIXAÇÃO A PAREDE					
4↔6,7	LUNF46ST-	92 €	106 €	118 €	102 €
6,8↔9,1	LUNF69ST-	131 €	153 €	166 €	147 €
9,2↔11,4	LUNF911ST-	146 €	164 €	181 €	158 €
11,5↔16	LUNF1116ST-	158 €	177 €	197 €	172 €
16,1↔20	LUNF1620ST-	177 €	197 €	217 €	191 €
FIJACIÓN A PARED LATERAL / FIXAÇÃO A PAREDE LATERAL					
4↔6,7	LUNF46STL-	119 €	131 €	146 €	127 €
6,8↔9,1	LUNF69STL-	164 €	186 €	204 €	177 €
9,2↔11,4	LUNF911STL-	172 €	192 €	211 €	184 €
11,5↔16	LUNF1116STL-	192 €	211 €	232 €	204 €
16,1↔20	LUNF1620STL-	205 €	224 €	246 €	214 €

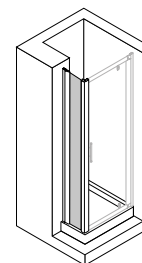

A

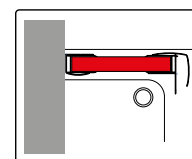

B

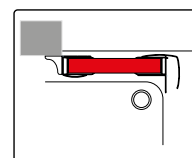

Construcción del código:
Construção do código

Código

+

Cristales
Vidros

+

Perfiles
Perfis

=

Código completo del producto
Código completo do produto

LUNES F SPECIAL 1



195 cm



4 mm



6 cm



PANEL FIJO ESPECIAL
PAINEL FIXO ESPECIAL



CRISTAL TEMPLADO VIDRO TEMPERADO



Transparente
cod 1



Aqua
cod 2



Niva
cod 11

COLORES PERFILES CORES PERFÍS



Blanco
Branco
cod. A



Silver
Abrillantado
cod. B



Cromo
cod K



Plata
Prata
cod J

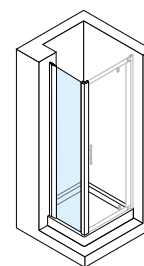

Medidas	Código	Selección Cristales Seleção Vidros			Selección de perfiles Seleção de perfis			
		1	2	11	A	B	K	J
		Transparente	Aqua	Niva	Blanco Branco	Silver Abrillantado	Cromo	Plata Prata
L 20↔39,9	LUNFSP				418 €	471 €	518 €	453 €
L 40↔65,9	LUNFSP		+ 40 €		436 €	490 €	540 €	472 €
L 66↔79,9	LUNFSP			+ 40 €	458 €	511 €	563 €	491 €
L 80↔100	LUNFSP				478 €	530 €	585 €	510 €
H 63↔200								

PARA MÁS OPCIONES DE PANELES FIJOS ESPECIALES, CONSULTAR LA TARIFA "AREA DE PROYECTOS"
PARA MAIS FIXOS ESPECIAIS, CONSULTAR A TARIFA "AREA DE PROYECTOS"

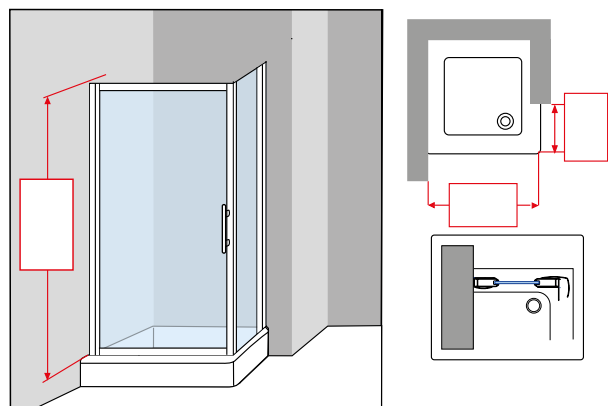

FIJOS DE ANCHO ESPECIAL. ALTURA DE 63 A 200 CM (ESPECIFICAR EN EL PEDIDO LA MEDIDA EXACTA)
FIXOS DE LARGURA ESPECIAL. ALTURA DE 63 A 200 CM (ESPECIFICAR NO PEDIDO A MEDIDA EXACTA)

LUNES F SPECIAL 2



195 cm



4 mm



6 cm



PANEL FIJO
PAINEL FIXO



CRISTAL TEMPLADO VIDRO TEMPERADO



Transparente
cod 1



Aqua
cod 2



Niva
cod 11

COLORES PERFILES CORES PERFIS



Blanco
Branco
cod. A



Silver
Abrillantado
cod. B



Cromo
cod K



Plata
Prata
cod J

Medidas	Código	Selección Cristales Seleção Vidros			Selección de perfiles Seleção de perfis			
		1	2	11	A	B	K	J
		Transparente	Aqua	Niva	Blanco Branco	Silver Abrillantado	Cromo	Plata Prata
L 30↔39,9	LUNF2SP				570 €	637 €	703 €	613 €
L 40↔65,9	LUNF2SP		+ 40 €	+ 40 €	625 €	700 €	769 €	672 €
L 66↔89,9	LUNF2SP				679 €	759 €	835 €	729 €
L 90↔100	LUNF2SP				712 €	798 €	880 €	766 €
H 93↑200								

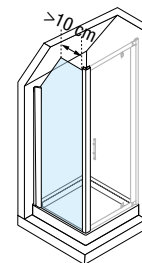

S Izquierda
Esquerda

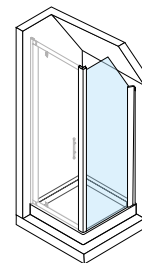

D Derecha
Direita

PARA MÁS OPCIONES DE PANELES FIJOS ESPECIALES, CONSULTAR LA TARIFA "AREA DE PROYECTOS"
PARA MAIS FIXOS ESPECIAIS, CONSULTAR A TARIFA "AREA DE PROYECTOS"

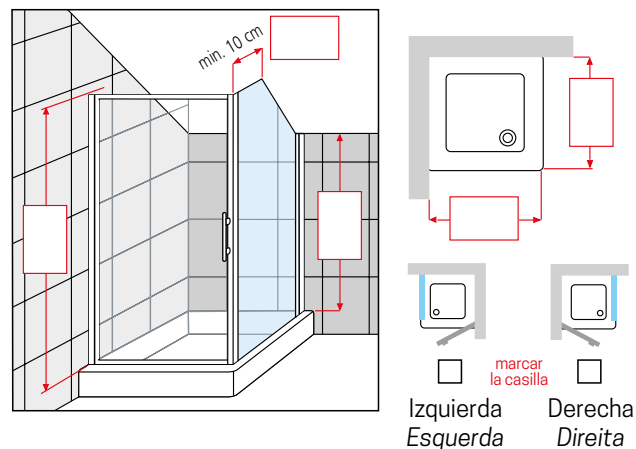

FIJOS DE ANCHO ESPECIAL. ALTURA DE 93 A 200 CM (ESPECIFICAR EN EL PEDIDO LA MEDIDA EXACTA)
FIXOS DE LARGURA ESPECIAL. ALTURA DE 93 A 200 CM (ESPECIFICAR NO PEDIDO A MEDIDA EXACTA)

Construcción del código: **Código** + **Cristales Vidros** + **Perfiles Perfis** = Código completo del producto
Construção do código

LUNES F SPECIAL 3

PANEL FIJO
PAINEL FIXO



CRISTAL TEMPLADO VIDRO TEMPERADO



Transparente
cod 1

Aqua
cod 2



Niva
cod 11

COLORES PERFILES CORES PERFÍS



Blanco
Branco
cod. A



Silver
Abrillantado
cod. B



Cromo
cod K



Plata
Prata
cod J

Medidas	Código	Selección Cristales Seleção Vidros			Selección de perfiles Seleção de perfis			
		1	2	11	A	B	K	J
L 67↔89,9	LUNF3SP	Transparente	Aqua	Niva	Blanco Branco	Silver Abrillantado	Cromo	Plata Prata
L 90↔110	LUNF3SP		+ 40 €	+ 40 €	700 €	780 €	859 €	749 €
H 110†200					726 €	806 €	887 €	774 €

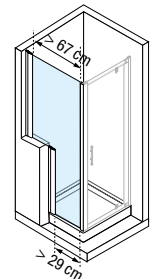

S Izquierda
Esquerda

PARA MÁS OPCIONES DE PANELES FIJOS ESPECIALES, CONSULTAR LA TARIFA "AREA DE PROYECTOS"
PARA MAIS FIXOS ESPECIAIS, CONSULTAR A TARIFA "AREA DE PROYECTOS"

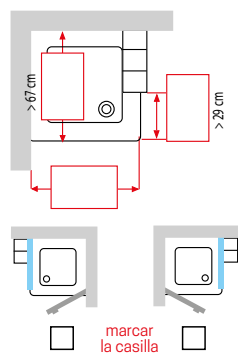
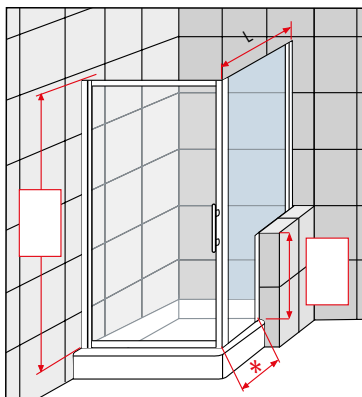

Izquierda
Esquerda

Derecha
Direita

LA MEDIDA * DEBE SER SUPERIOR A 1/3 DE LA MEDIDA DE LUZ Y NO INFERIOR A 20 CM

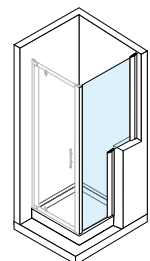

D Derecha
Direita

FIJOS DE ANCHO ESPECIAL. ALTURA DE 110 A 200 CM (ESPECIFICAR EN EL PEDIDO LA MEDIDA EXACTA)
FIXOS DE LARGURA ESPECIAL. ALTURA DE 110 A 200 CM (ESPECIFICAR NO PEDIDO A MEDIDA EXACTA)

LUNES F SPECIAL 4



195 cm



4 mm



6 cm



PANEL FIJO
PAINEL FIXO



CRISTAL TEMPLADO VIDRO TEMPERADO



Transparente
cod 1



Aqua
cod 2



Niva
cod 11

COLORES PERFILES CORES PERFIS



Blanco
Branco
cod. A



Silver
Abrillantado
cod. B



Cromo
cod K



Plata
Prata
cod J

Medidas	Código	Selección Cristales Seleção Vidros			Selección de perfiles Seleção de perfis			
		1	2	11	A	B	K	J
		Transparente	Aqua	Niva	Blanco Branco	Silver Abrillantado	Cromo	Plata Prata
L 20↔39,9	LUNF4SP				411 €	463 €	510 €	444 €
L 40↔65,9	LUNF4SP		+ 40 €	+ 40 €	444 €	498 €	548 €	478 €
L 66↔89,9	LUNF4SP				483 €	546 €	601 €	525 €
L 90↔102	LUNF4SP				525 €	585 €	643 €	561 €

H 25↔195

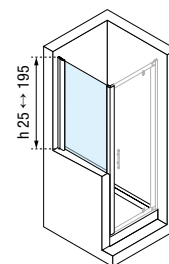

PARA MÁS OPCIONES DE PANELES FIJOS ESPECIALES, CONSULTAR LA TARIFA "AREA DE PROYECTOS"
PARA MAIS FIXOS ESPECIAIS, CONSULTAR A TARIFA "AREA DE PROYECTOS"

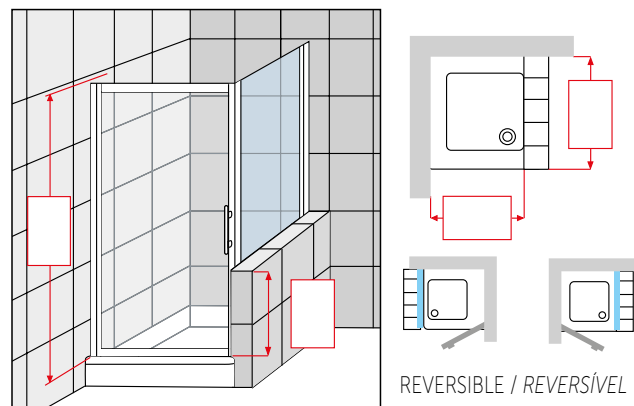

FIJOS DE ANCHO ESPECIAL. ALTURA DE 25 A 190 CM (ESPECIFICAR EN EL PEDIDO LA MEDIDA EXACTA)
FIXOS DE LARGURA ESPECIAL. ALTURA DE 25 A 190 CM (ESPECIFICAR NO PEDIDO A MEDIDA EXACTA)

Construcción del código: **Código** + **Cristales Vidros** + **Perfiles Perfis** = Código completo del producto
Construção do código

LUNES F SPECIAL 5



PANEL FIJO ESPECIAL
PAINEL FIXO ESPECIAL



FIJACIÓN EN LÍNEA
FIXAÇÃO EM LINHA



PAREDES DIVISORIAS



FIJACIÓN A PARED LATERAL
FIXAÇÃO A PAREDE



EN LÍNEA SOBRE MURETE
EM LINHA SOBRE PAREDE

FIJACIÓN EN LÍNEA / FIXAÇÃO EM LINHA

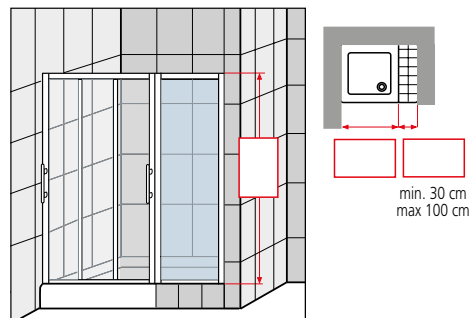

PAREDES DIVISORIAS

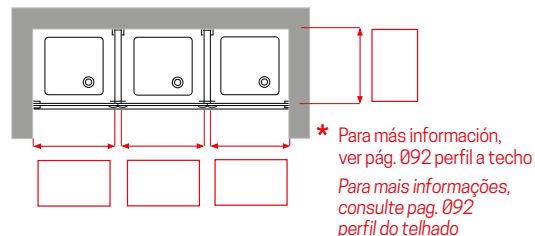
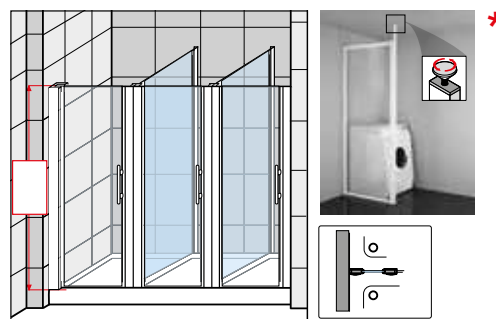

* Para más información, ver pág. 092 perfil a techo
Para mais informações, consulte pag. 092 perfil do telhado

FIJACIÓN A PARED LATERAL / FIXAÇÃO A PAREDE

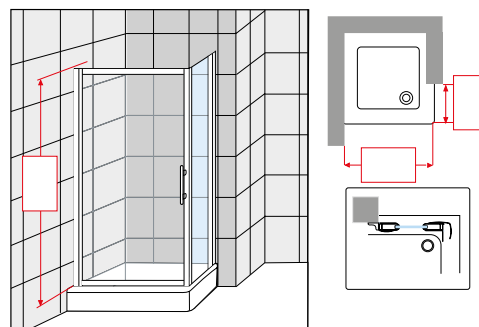

EN LÍNEA SOBRE MURETE / EM LINHA SOBRE PAREDE

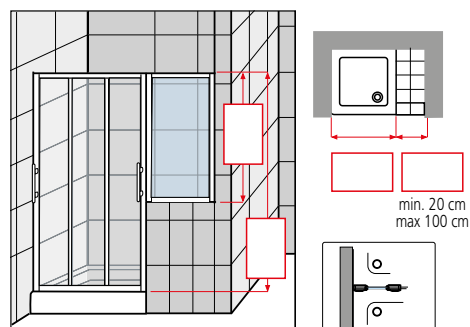

Medidas	Código	Selección Cristales Seleção Vidros			Selección de perfiles Seleção de perfis			
		1	2	11	A	B	K	J
		Transparente	Aqua	Niva	Blanco Branco	Silver Abrrilantado	Cromo	Plata Prata

FIJACIÓN EN LÍNEA / FIXAÇÃO EM LINHA

H 25↔59,9	LUNF5SP				418 €	471 €	518 €	453 €
H 60↔95,9	LUNF5SP				471 €	525 €	578 €	504 €
H 96↔159,9	LUNF5SP	+ 40 €	+ 40 €		504 €	570 €	630 €	549 €
H 160↔189,9	LUNF5SP				537 €	604 €	665 €	582 €
H 190↔200	LUNF5SP				570 €	637 €	703 €	613 €

FIJO LATERAL / FIXO LATERAL

H 25↔59,9	LUNF5SP				452 €	511 €	563 €	491 €
H 60↔95,9	LUNF5SP				504 €	564 €	622 €	542 €
H 96↔159,9	LUNF5SP	+ 40 €	+ 40 €		537 €	604 €	665 €	582 €
H 160↔189,9	LUNF5SP				570 €	637 €	703 €	613 €
H 190↔200	LUNF5SP				604 €	671 €	739 €	644 €

FIJACIÓN A PARED LATERAL / FIXAÇÃO A PAREDE LATERAL

H 25↔59,9	LUNF5SP				483 €	546 €	601 €	525 €
H 60↔95,9	LUNF5SP				537 €	598 €	659 €	576 €
H 96↔159,9	LUNF5SP	+ 40 €	+ 40 €		570 €	637 €	703 €	613 €
H 160↔189,9	LUNF5SP				604 €	671 €	739 €	644 €
H 190↔200	LUNF5SP				644 €	712 €	785 €	684 €

FIJOS DE ALTURA ESPECIAL. ANCHO DE 20 A 100 CM (ESPECIFICAR EN EL PEDIDO LA MEDIDA EXACTA)
FIXOS DE ALTURA ESPECIAL. LARGURA DE 20 A 100 CM (ESPECIFICAR NO PEDIDO A MEDIDA EXACTA)

DATOS TÉCNICOS / DADOS TÉCNICOS

COLORES PERFILES / CORES PERFÍS



Blanco
Branco
cod. D



Silver
Abrillantado
cod. B



Cromo
cod. K



Plata
Prata
cod. J

CRISTAL TEMPLADO / VIDRO TEMPERADO 6 mm (Según norma Europea UNE EN 14428)



Transparente
cod. 1



Niva
cod. 11



Aqua
cod. 2



Lunes 2.0
cod. 78



Tirador cromo / Blanco
Puxador cromo / Branco

SERIGRAFIA

TIRADOR / PUXADOR

MEDIDAS QUE OCUPAN LOS PERFILES EN LA PARED / ESPAÇO QUE OCUPAN OS PERFÍS NA PAREDE

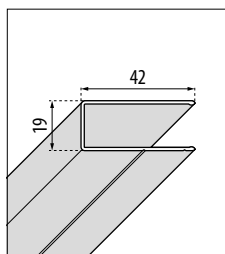

A PARED
R - 2A - 2P - 2PH
A - AH - 3PH

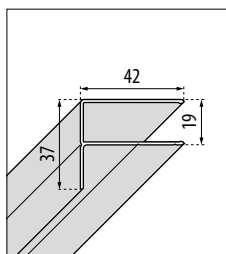

A PARED
G+FL - 3P - S - B - G

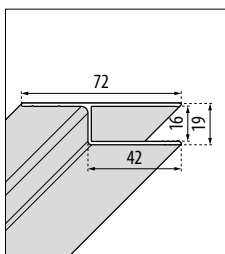

A PARED
perfil de la pared lateral
todos los modelos

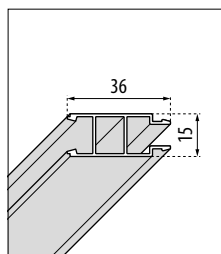

COMPENSADORES
R - 2A - G+FL + 3P +
3PH - G - B - S - 2P -
2PH - A - AH

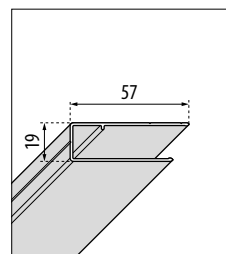

COMPENSADORES
R - 2A - 2P - 2PH
A - AH - 3PH

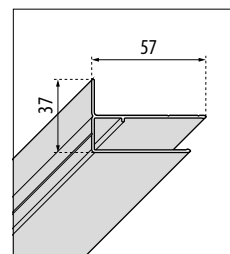

COMPENSADORES
G+FL - 3P - S - B - G

Color / Cores	Código	Color / Cores	Código	Color / Cores	Código	Color / Cores	Código	Color / Cores	Código	Color / Cores	Código
Blanco Branco	P01BJMOST-A	Blanco Branco	P01BJGBST-A	Blanco Branco	P01L215STL-A	Blanco Branco	P05HAAST3-A	Blanco Branco	P05BHST-A	Blanco Branco	P05BHCST-A
Silver Abrillantado	P01BJMOST-B	Silver Abrillantado	P01BJGBST-B	Silver Abrillantado	P01L215STL-B	Silver Abrillantado	P05HAAST3-B	Silver Abrillantado	P05BHST-B	Silver Abrillantado	P05BHCST-B
Cromo	P01BJMOST-K	Cromo	P01BJGBST-K	Cromo	P01L215STL-K	Cromo	P05HAAST3-K	Cromo	P05BHST-K	Cromo	P05BHCST-K
Plata Prata	P01BJMOST-J	Plata Prata	P01BJGBST-J	Plata Prata	P01L215STL-J	Plata Prata	P05HAAST3-J	Plata Prata	P05BHST-J	Plata Prata	P05BHCST-J

TOMA DE MEDIDAS

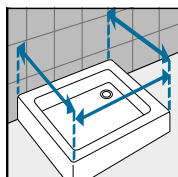
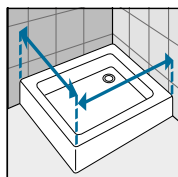

Tomar las medidas desde la pared hasta el borde externo del plato de ducha.
Medir a distância desde a parede até o rebordo externo da base de chuveiro.

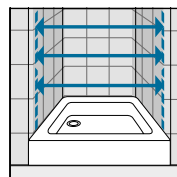
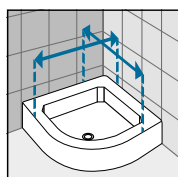

Tomar medidas de pared a pared, medir la parte baja, la central y la superior. Cursar el pedido con la medida más pequeña.
Medir a distância entre paredes, tem que tirar três medidas (inferior, superior e central) e utilizar a inferior. Encomendar pedido da medida mais pequena.

STAR 2.0

APTO PARA CUALQUIER SOLUCIÓN.
AHORA CON MAYOR ALTURA.



DISPONIBLE A PARTIR DE ABRIL 2023
DISPONÍVEL A PARTIR DE ABRIL 2023



◀ Perfil tirador para evitar obstáculos externos
Perfil puxador de manuseamento para evitar obstáculos externos



◀ **NEWS 2023**
Altura 195 cm



◀ La mayor profundidad de alcance del mundo Novellini
A mais ampla profundidade de alcance no mundo Novellini



La mampara de ducha versátil en soluciones estéticas. Adaptable a cualquier solución de baño gracias a las innumerables posibilidades de instalación, Star se convierte en la protagonista del cuidado personal. La amplia gama de acabados le permite adaptar el modelo a sus deseos y realizar un proyecto de baño funcional y de buen gusto.

O versátil recinto de duche em soluções estéticas. Confortável a qualquer solução de casa de banho graças às inúmeras possibilidades de instalação, a Star torna-se a protagonista do autocuidado. A vasta gama de acabamentos permite-lhe adaptar o modelo aos seus desejos e realizar um projecto de casa de banho de bom gosto e funcional.



STAR 2.0

STAR 2.0 A



MAMPARA ANGULAR DE DOS PUERTAS CORREDERAS + DOS FIJOS
RESGUARDO ANGULAR DE DUAS PORTS DE CORRER + DOS FIXOS

Medidas			Código	Selección Cristales Seleção Vidros			Selección de perfiles Seleção de perfis		Selección acrílico Seleção acrílico	Selección de perfiles Seleção de perfis	
Medidas extensibilidad Medidas extensibilidade	Fijo frontal Fixo frontal	Entrada		1	11	38	A	B	43	A	B
A	F1	*		Transparente	Niva	Serigrafía Punto	Blanco Branco	Silver Abrillatado	circular	Blanco Branco	Silver Abrillatado
66↔72	33	35	STA2A66L-				296 €	329 €		276 €	307 €
72↔78	36	39	STA2A72L-				302 €	334 €		281 €	313 €
78↔84	39	43	STA2A78L-				310 €	345 €		286 €	318 €
84↔90	42	48	STA2A84L-		+ 40 €	+ 40 €	316 €	350 €		292 €	323 €
90↔96	45	52	STA2A90L-				339 €	376 €		313 €	345 €
96↔102	48	56	STA2A96L-				369 €	408 €		345 €	382 €
114↔120	57	69	STA2A114L-				391 €	435 €		360 €	398 €
LATERAL DE ALTURA ESPECIAL											
H 140↔200			STA2ALS	+ 40 €	-		490 €	541 €		451 €	498 €

PARA COMPONER UN ÁNGULO PEDIR 2 LATERALES
FORMAR UM ÂNGULO PEDINDO DOIS LATERAIS

SE PUEDE PEDIR UN FIJO LATERAL PARA CUBRIR 3 LADOS
PODE-SE PEDIR UM FIXO LATERAL PARA COMPLETAR 3 LADOS

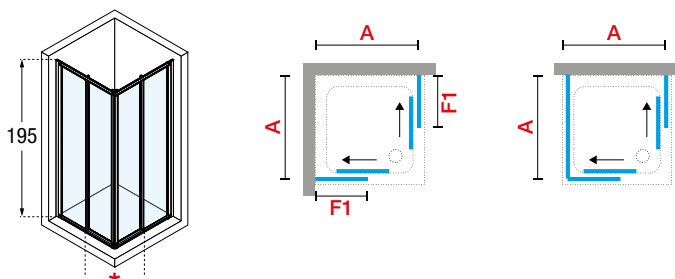



CRISTAL TEMPLADO / VIDRO TEMPERADO



Transparente
cod 1



Niva
cod 11

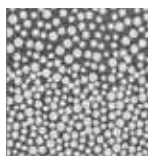

Ser. Punto
cod 38



Circular
cod 43

COLORES PERFILES / CORES PERFÍS



Blanco
Branco
cod. A

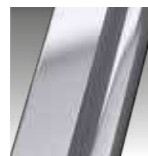

Silver
Abrillantado
cod. B

STAR 2.0 2P



195 cm



3 mm



6 cm



PUERTA DE DOS HOJAS: UNA CORREDERA + UNA FIJA Para instalar entre paredes o con fijo lateral STAR F

RESGUARDO DE DUAS FOLHIAS: UNA DE CORRER + UNA FIXA Para instalar entre paredes ou com fixo lateral STAR F



CRISTAL TEMPLADO VIDRO TEMPERADO



Transparente
cod 1



Niva
cod 11

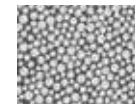

Ser. Punto
cod 38



Circular
cod 43

COLORES PERFILES CORES PERFÍS



Blanco
Branco
cod. A



Silver
Abrillantado
cod. B

Medidas			Código	Selección Cristales Seleção Vidros			Selección de perfiles Seleção de perfis		selección acrílico Seleção acrílico	Selección de perfiles Seleção de perfis	
Medidas extensibilidad Medidas extensibilidade	Fijo frontal Fixo frontal	Entrada		1	11	38	A	B		A	B
A	F1	*		Transparente	Niva	Serigrafía Punto	Blanco Branco	Silver Abrillantado	circular	Blanco Branco	Silver Abrillantado
96↔102	47	39	STA22P96-				532 €	588 €		493 €	546 €
102↔108	50	42	STA22P102-				554 €	615 €		514 €	567 €
108↔114	53	45	STA22P108-				577 €	636 €		535 €	594 €
114↔120	56	48	STA22P114-				598 €	663 €		551 €	610 €
120↔126	59	51	STA22P120-				620 €	684 €		572 €	631 €
126↔132	62	54	STA22P126-				651 €	721 €		599 €	663 €
132↔138	65	57	STA22P132-				671 €	742 €		620 €	684 €
138↔144	68	60	STA22P138-				694 €	769 €		641 €	710 €
144↔150	71	63	STA22P144-				714 €	790 €		663 €	731 €
150↔156	74	66	STA22P150-				737 €	811 €		678 €	747 €
156↔162	77	69	STA22P156-				760 €	837 €		700 €	774 €
PUERTA DE ALTURA ESPECIAL											
H 140↔200			STA22P2SP	+ 40 €	-		951 €	1.049 €		875 €	965 €

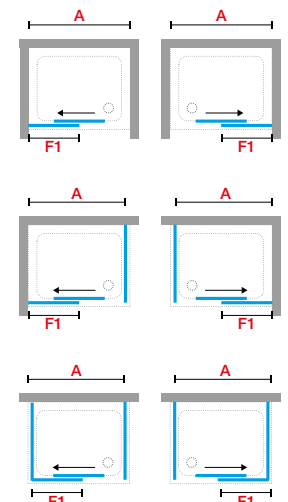
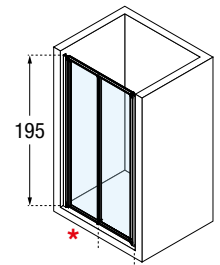

SE PUEDE PEDIR UN FIJO LATERAL PARA CUBRIR 3 LADOS
PODE-SE PEDIR UM FIXO LATERAL PARA COMPLETAR 3 LADOS

STAR 2.0 R



195 cm



3 mm



3 cm



MAMPARA SEMICIRCULAR DE DOS PUERTAS CORREDERAS + DOS FIJOS
RESGUARDO PARA BASE SEMICIRCULAR COMPUESTO POR DUAS PORTAS DE CORRER



CRISTAL TEMPLADO VIDRO TEMPERADO



Transparente
cod 1



Niva
cod 11

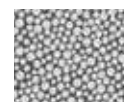

Ser. Punto
cod 38



Circular
cod 43

COLORES PERFILES CORES PERFIS



Blanco
Branco
cod. A



Silver
Abrilantado
cod. B

Medidas			Código	Selección Cristales Seleção Vidros			Selección de perfiles Seleção de perfis		selección acrílico Seleção acrílico	Selección de perfiles Seleção de perfis	
Medidas extensibilidad Medidas extensibilidade	Fijo frontal Fijo frontal	Entrada		1	11	38	A	B	43	A	B
A	F1	*		Transpa- rente	Niva	Serigrafía Punto	Blanco Branco	Silver Abrilantado	circular	Blanco Branco	Silver Abrilantado
78,5↔81,5 x 78,5↔81,5	24	40	STA2R80-				869 €	959 €		800 €	885 €
88,5↔91,5 x 88,5↔91,5	34	54	STA2R90-	+ 80 €	+ 80 €		914 €	1.007 €		843 €	928 €
98,5↔101,5 x 98,5↔101,5	44	54	STA2R100-				943 €	1.039 €		869 €	959 €

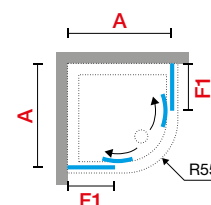
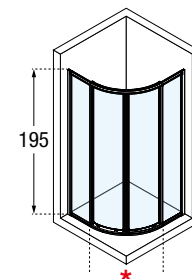

**PUERTA EXTRAÍBLE PARA
FACILITAR
LA LIMPIEZA**

Construcción del código: **Código** + **Cristales/acrílico** + **Perfiles** = Código completo del producto
 Construção do código: **Código** + **Vidros/acrílico** + **Perfis** = Código completo do produto

STAR 2.0 3P



195 cm



3 mm



6 cm



MAMPARA DE TRES HOJAS CORREDERAS Para instalar entre paredes o con fijo lateral STAR F
RESGUARDO DE TRES FOLHAS DE CORRER Para instalar entre paredes ou com fixo lateral STAR F



CRISTAL TEMPLADO VIDRO TEMPERADO



Transparente
cod 1



Niva
cod 11

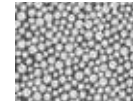

Ser. Punto
cod 38



Circular
cod 43

COLORES PERFILES CORES PERFÍS



Blanco
Branco
cod. A



Silver
Abrillantado
cod. B

Medidas		Código	Selección Cristales Seleção Vidros			Selección de perfiles Seleção de perfis		selección acrílico Seleção acrílico	Selección de perfiles Seleção de perfis	
Medidas extensibilidad Medidas extensibilidade	Entrada		1	11	38	A	B		43	A
A	*		Transpa- rente	Niva	Serigrafía Punto	Blanco Branco	Silver Abrillantado	circular	Blanco Branco	Silver Abrillantado
78↔84	43	STA23P78-				615 €	678 €		567 €	625 €
84↔90	47	STA23P84-				636 €	700 €		588 €	652 €
90↔96	51	STA23P90-				657 €	726 €		610 €	673 €
96↔102	55	STA23P96-		+ 40 €	+ 40 €	678 €	747 €		625 €	689 €
102↔108	59	STA23P102-				721 €	795 €		668 €	737 €
108↔114	63	STA23P108-				753 €	832 €		694 €	769 €
114↔120	67	STA23P114-				784 €	864 €		726 €	800 €
PUERTA DE ALTURA ESPECIAL										
H 140↔200 L 66↔114		STA23PSP	+ 40 €	-		965 €	1.065 €		912 €	1.007 €

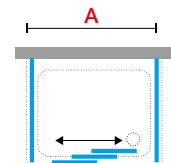
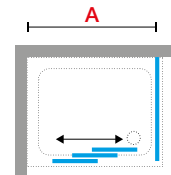
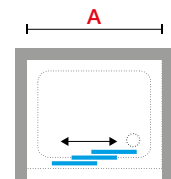
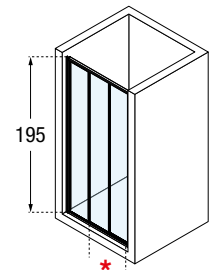

SE PUEDE PEDIR UN FIJO LATERAL PARA CUBRIR 3 LADOS
PODE-SE PEDIR UM FIXO LATERAL PARA COMPLETAR 3 LADOS

STAR 2.0 G



195 cm



3 mm



6 cm



MAMPARA DE DUCHA ABATIBLE DE UNA HOJA Para instalar entre paredes o con fijo lateral STAR F

RESGUARDO DE DUCHE DE ABRIR DE UMA FOLHA Para instalar entre paredes ou com fixo lateral STAR F



CRISTAL TEMPLADO VIDRO TEMPERADO



Transparente
cod 1



Niva
cod 11

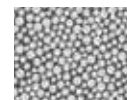

Ser. Punto
cod 38



Circular
cod 43

COLORES PERFILES CORES PERFIS



Blanco
Branco
cod. A



Silver
Abrilantado
cod. B

Medidas			Código	Selección Cristales Seleção Vidros			Selección de perfiles Seleção de perfis		selección acrílico Seleção acrílico	Selección de perfiles Seleção de perfis	
Medidas extensibilidad Medidas extensibilidade	Entrada	Espacio de apertura Espaço de abertura		1	11	38	A	B	43	A	B
A	*	B		Transparente	Niva	Serigrafia Punto	Blanco Branco	Silver Brillantado	circular	Blanco Branco	Silver Brillantado
66↔72	45	45	STA2G66-				378 €	419 €		350 €	387 €
72↔78	51	51	STA2G72-				391 €	435 €		360 €	398 €
78↔84	52	52	STA2G78-		+ 40 €	+ 40 €	408 €	451 €		376 €	419 €
84↔90	58	58	STA2G84-				422 €	466 €		392 €	435 €
PUERTA DE ALTURA ESPECIAL											
H 140↑200		ESPECIAL	STA2GSP		+ 40 €	-	528 €	583 €		493 €	546 €

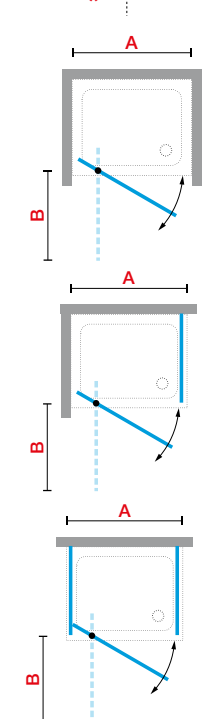
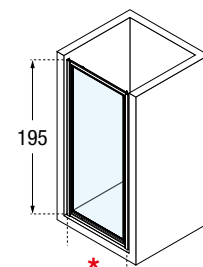

SE PUEDE PEDIR UN FIJO LATERAL PARA CUBRIR 3 LADOS
PODE-SE PEDIR UM FIXO LATERAL PARA COMPLETAR 3 LADOS

Construcción del código: Código + Cristales/acrílico + Perfiles Perfis = Código completo del producto
Construção do código: Código + Vidros/acrílico + Perfis = Código completo do produto

STAR 2.0 B



MAMPARA DE DOS HOJAS ABATIBLES Para instalar entre paredes o con fijo lateral STAR F

RESGUARDO DE DUCHE DE DUAS FOLHAS ABATIVEIS Para instalar entre paredes ou com fixo lateral STAR F



CRISTAL TEMPLADO VIDRO TEMPERADO



Transparente
cod 1



Niva
cod 11

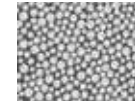

Ser. Punto
cod 38



Circular
cod 43

COLORES PERFILES CORES PERFÍS



Blanco
Branco
cod. A



Silver
Abrillantado
cod. B

Medidas					Código	Selección Cristales Seleção Vidros			Selección de perfiles Seleção de perfis		selección acrílico Seleção acrílico	Selección de perfiles Seleção de perfis			
Medidas extensibilidad Medidas extensibilidade	Entrada		Espacio de apertura Espaço de abertura			1	11	38	A	B	43	A	B		
	crystal vidro	Acrílico			Transparente									Niva	Serigrafía Punto
A	*		B												
66↔72	49	44	20	22	STA2B66-				500 €	551 €		461 €	509 €		
72↔78	55	50	23	25	STA2B72-				516 €	572 €		477 €	525 €		
78↔84	61	56	26	28	STA2B78-				532 €	588 €		493 €	546 €		
84↔90	67	62	29	31	STA2B84-				561 €	620 €		519 €	572 €		
90↔96	73	68	32	34	STA2B90-				578 €	636 €		535 €	594 €		
96↔102	79	74	35	37	STA2B96-				607 €	673 €		562 €	620 €		
PUERTA DE ALTURA ESPECIAL															
H 140↔200			SPECIAL		STA2BSP				+ 40 €	-		760 €	837 €	705 €	779 €

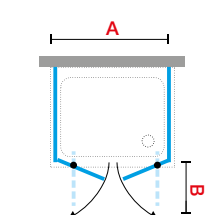
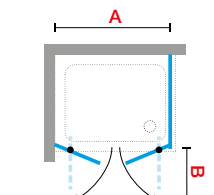
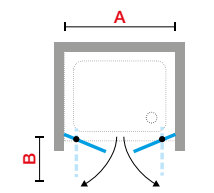
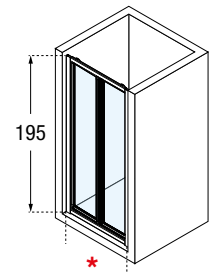

STAR 2.0 S



MAMPARA PLEGABLE DE DOS HOJAS Para instalar entre paredes o con fijo lateral STAR F

RESGUARDO DESDOBRÁVEL DE DUAS FOLHAS Para instalar entre paredes ou com fixo lateral STAR F



CRISTAL TEMPLADO VIDRO TEMPERADO



Transparente
cod 1



Niva
cod 11

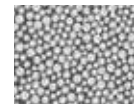

Ser. Punto
cod 38



Circular
cod 43

COLORES PERFILES CORES PERFIS



Blanco
Branco
cod. A



Silver
Abrilantado
cod. B

Medidas			Código	Selección Cristales Seleção Vidros			Selección de perfiles Seleção de perfis		selección acrílico Seleção acrílico	Selección de perfiles Seleção de perfis	
Medidas extensibilidad Medidas extensibilidade	Entrada	Espacio de apertura Espaço de abertura		1	11	38	A	B	43	A	B
A	*	B		Transpa- rente	Niva	Serigrafia Punto	Blanco Branco	Silver Abrilantado	circular	Blanco Branco	Silver Abrilantado
66↔72	46	31-29	STA2S66-				532 €	588 €		493 €	546 €
72↔78	52	34-32	STA2S72-				577 €	636 €		535 €	594 €
78↔84	58	37-35	STA2S78-				620 €	684 €		572 €	631 €
84↔90	64	40-38	STA2S84-		+ 40 €	+ 40 €	665 €	731 €		615 €	678 €
90↔96	70	42-40	STA2S90-				694 €	769 €		641 €	710 €
96↔102	76	45-43	STA2S96-				724 €	800 €		668 €	737 €
PUERTA DE ALTURA ESPECIAL											
H 140↑200	ESPECIAL		STA2SSP	+ 40 €	-		905 €	996 €		790 €	869 €

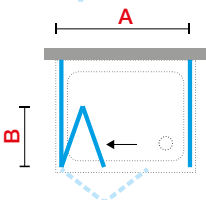
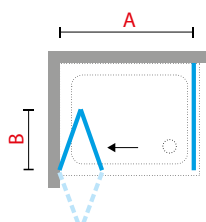
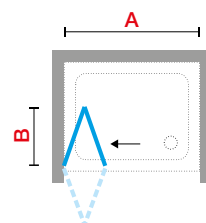
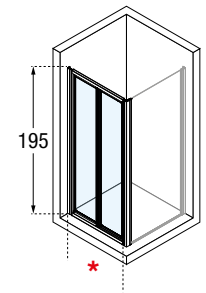

SE PUEDE PEDIR UN FIJO LATERAL PARA CUBRIR 3 LADOS
PODE-SE PEDIR UM FIXO LATERAL PARA COMPLETAR 3 LADOS



**APERTURA DE SEGURIDAD: LA APERTURA HACIA EL EXTERIOR
SE CONSIDERA SÓLO COMO APERTURA DE EMERGENCIA.**
**ABERTURA DE SEGURANÇA: ABERTURA PARA O EXTERIOR
É CONSIDERADA ÚNICA ABERTURA DE EMERGÊNCIA.**

Construcción del código: **Código** + **Cristales/acrílico** + **Perfiles** = Código completo del producto
Construção do código: **Código** + **Vidros/acrílico** + **Perfis** = Código completo do produto

STAR 2.0 F

PANEL FIJO
PAINEL FIXO



CRISTAL TEMPLADO VIDRO TEMPERADO



COLORES PERFILES CORES PERFÍS



Medidas	Código	Selección Cristales Seleção Vidros			Selección de perfiles Seleção de perfis		selección acrílico Seleção acrílico	Selección de perfiles Seleção de perfis	
		1	11	38	A	B		43	A
Medidas extensibilidad Medidas extensibilidade									
F		Transparente	Niva	Serigrafía Punto	Blanco Branco	Silver Abrillantado	circular	Blanco Branco	Silver Abrillantado
66↔72	STA2F66-				281 €	313 €		260 €	286 €
72↔78	STA2F72-				297 €	329 €		276 €	307 €
78↔84	STA2F78-				312 €	345 €		292 €	323 €
84↔90	STA2F84-		+ 40 €	+ 40 €	326 €	360 €		302 €	334 €
90↔96	STA2F90-				356 €	392 €		329 €	366 €
96↔102	STA2F96-				386 €	429 €		355 €	392 €

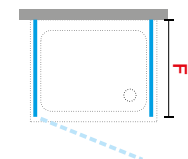
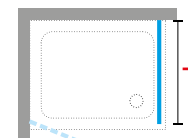
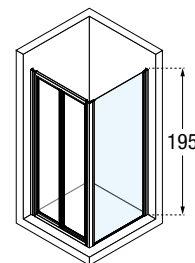

PANEL FIJO EN METACRILATO CON PERFIL SUPERIOR E INFERIOR. PARA SOLUCIÓN CON DOS PANELES FIJOS LATERALES, UTILIZAR SIEMPRE 2 BARRAS ESTABILIZADORAS EN ÁNGULO.

STAR 2.0 F (SÓLO PERFILES)

ALTURA 1950 mm



6 cm



COLORES PERFILES CORES PERFÍS



Blanco
Branco
cod. A



Silver
Abrillantado
cod. B

Medidas	Código	Selección de perfiles Seleção de perfis	
		A	B
Medidas extensibilidad Medidas extensibilidade		Blanco Branco	Silver Abrillantado
FIJACIÓN FRONTAL / FIXAÇÃO FRONTAL			
4↔6,7	STA2F46ST-	92 €	106 €
6,8↔9,1	STA2F69ST-	131 €	153 €
9,2↔11,4	STA2F911ST-	146 €	164 €
11,5↔16	STA2F1116ST-	158 €	177 €
16,1↔20	STA2F1620ST-	177 €	197 €
B FIJACIÓN LATERAL / FIXAÇÃO LATERAL			
4↔6,7	STA2F46STL-	119 €	131 €
6,8↔9,1	STA2F69STL-	164 €	186 €
9,2↔11,4	STA2F911STL-	172 €	192 €
11,5↔16	STA2F1116STL-	192 €	211 €
16,1↔20	STA2F1620STL-	205 €	224 €

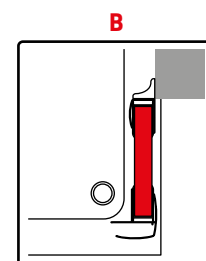
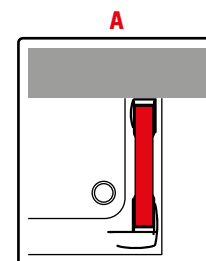
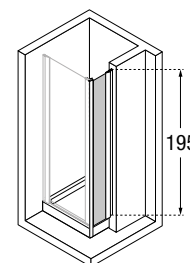

STAR 2.0 F SPECIAL 1

PANEL FIJO ESPECIAL
PAINEL FIXO ESPECIAL



4 mm



3 mm
acrílico



6 cm



CRISTAL TEMPLADO VIDRO TEMPERADO



Transparente
cod 1



Niva
cod 11



Circular
cod 43

COLORES PERFILES CORES PERFÍS



Blanco
Branco
cod. A



Silver
Abrillantado
cod. B

Medidas	Código	Selección Cristales Seleção Vidros		Selección de perfiles Seleção de perfis		selección acrílico Seleção acrílico	Selección de perfiles Seleção de perfis	
		1	11	A	B	43	A	B
		Transparente	Niva	Blanco Branco	Silver Abrillantado	circular	Blanco Branco	Silver Abrillantado
L 20↔65,9	STA2F1SP			439 €	488 €		408 €	451 €
L 66↔89,9	STA2F1SP		+ 40 €	509 €	562 €		472 €	519 €
L 90↔96	STA2F1SP			544 €	599 €		504 €	557 €

H 80↔200

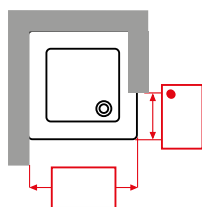
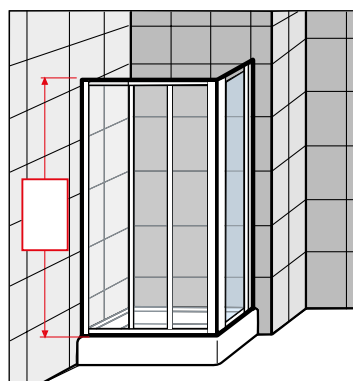
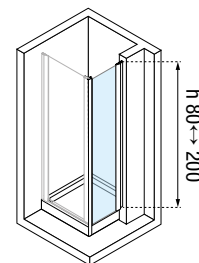

NO SE SUMINISTRA EL PERFIL DE FIJACIÓN A PARED

PARA MÁS OPCIONES DE PANELES FIJOS ESPECIALES, CONSULTAR LA TARIFA "ÁREA DE PROYECTOS"

PARA MAIS FIXOS ESPECIAIS, CONSULTAR A TARIFA "ÁREA DE PROYECTOS"

FIJOS DE ANCHO ESPECIAL. ALTURA DE 80 A 200 CM (ESPECIFICAR EN EL PEDIDO LA MEDIDA EXACTA)

FIXOS DE LARGURA ESPECIAL. ALTURA DE 80 A 200 CM (ESPECIFICAR NO PEDIDO A MEDIDA EXACTA)



STAR 2.0 F SPECIAL 2



195 cm



4 mm



3 mm
acrílico



PANEL FIJO ESPECIAL
PAINEL FIXO ESPECIAL



CRISTAL TEMPLADO VIDRO TEMPERADO



Transparente
cod 1



Niva
cod 11



Circular
cod 43

COLORES PERFILES CORES PERFIS



Blanco
Branco
cod. A



Silver
Abrillantado
cod. B

Medidas	Código	Selección Cristales Seleção Vidros		Selección de perfiles Seleção de perfis		selección acrílico Seleção acrílico	Selección de perfiles Seleção de perfis	
		1	11	A	B		43	A
L 30↔65,9	STA2F2SP	Transparente	Niva	Blanco Branco	Silver Abrillantado	circular	Blanco Branco	Silver Abrillantado
L 66↔89,9	STA2F2SP		+ 40 €	613 €	678 €		567 €	625 €
L 90↔102	STA2F2SP			643 €	710 €		594 €	657 €
H 90‡200				660 €	731 €		610 €	673 €

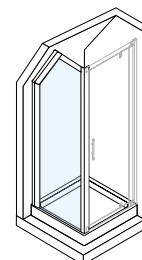

S Izquierda
Esquerda

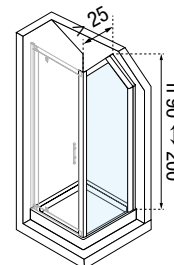

D Derecha
Direita

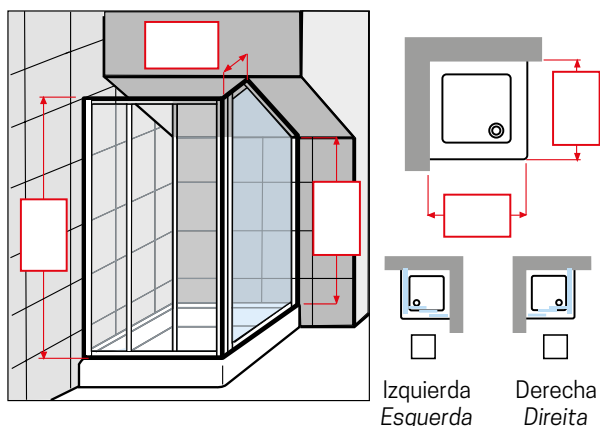

PARA MÁS OPCIONES DE PANELES FIJOS ESPECIALES, CONSULTAR LA TARIFA "ÁREA DE PROYECTOS"
PARA MAIS FIXOS ESPECIAIS, CONSULTAR A TARIFA "ÁREA DE PROYECTOS"
FIJOS DE ANCHO ESPECIAL. ALTURA DE 90 A 200 CM (ESPECIFICAR EN EL PEDIDO LA MEDIDA EXACTA)
FIXOS DE LARGURA ESPECIAL. ALTURA DE 90 A 200 CM (ESPECIFICAR NO PEDIDO A MEDIDA EXACTA)

Construcción del código: **Código** + **Cristales/acrílico** + **Perfiles** = Código completo del producto
Construção do código: **Código** + **Vidros/acrílico** + **Perfis** = Código completo do produto

STAR 2.0 F SPECIAL 3

PANEL FIJO ESPECIAL
PAINEL FIXO ESPECIAL



4 mm



3 mm
acrílico



CRISTAL TEMPLADO VIDRO TEMPERADO



Transparente
cod 1



Niva
cod 11



Circular
cod 43

COLORES PERFILES CORES PERFÍS



Blanco
Branco
cod. A



Silver
Abrillantado
cod. B

Medidas	Código	Selección Cristales Seleção Vidros		Selección de perfiles Seleção de perfis		selección acrílico Seleção acrílico	Selección de perfiles Seleção de perfis	
		1	11	A	B	43	A	B
		Transparente	Niva	Blanco Branco	Silver Abrillantado	43	Blanco Branco	Silver Abrillantado
L 45↔65,9	STA2F3SP			613 €	678 €		567 €	625 €
L 66↔89,9	STA2F3SP		+ 40 €	643 €	710 €		594 €	657 €
L 90↔102	STA2F3SP			659 €	726 €		610 €	673 €

H 100↔200

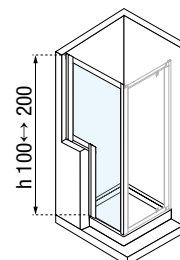

S Izquierda
Esquerda

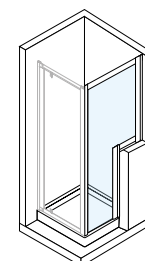

D Derecha
Direita

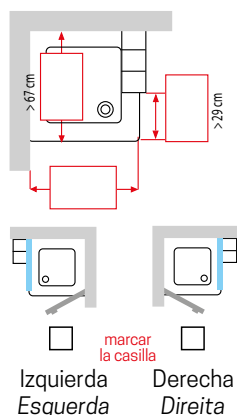
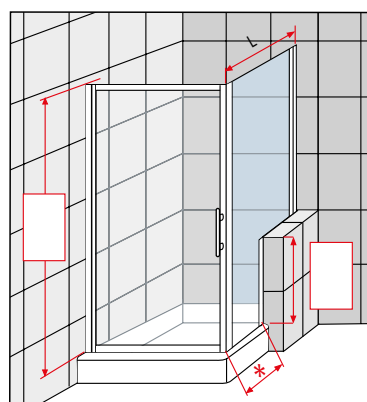

MEDIDA * DEBE SER SUPERIOR
A 1/3 DE LA MEDIDA DE LUZ Y NO
INFERIOR A 20 CM

PARA MÁS OPCIONES DE PANELES FIJOS ESPECIALES, CONSULTAR LA TARIFA "ÁREA DE PROYECTOS"

PARA MAIS FIXOS ESPECIAIS, CONSULTAR A TARIFA "ÁREA DE PROYECTOS"

FIJOS DE ANCHO ESPECIAL. ALTURA DE 100 A 200 CM (ESPECIFICAR EN EL PEDIDO LA MEDIDA EXACTA)

FIXOS DE LARGURA ESPECIAL. ALTURA DE 100 A 200 CM (ESPECIFICAR NO PEDIDO A MEDIDA EXACTA)



STAR 2.0 F SPECIAL 4



4 mm



3 mm
acrílico



6 cm



PANEL FIJO ESPECIAL
PAINEL FIXO ESPECIAL



CRISTAL TEMPLADO VIDRO TEMPERADO



Transparente
cod 1



Niva
cod 11



Circular
cod 43

COLORES PERFILES CORES PERFIS



Blanco
Branco
cod. A



Silver
Abrilantado
cod. B

Medidas	Código	Selección Cristales Seleção Vidros		Selección de perfiles Seleção de perfis		selección acrílico Seleção acrílico	Selección de perfiles Seleção de perfis	
		1	11	A	B		43	A
L 30↔65,9	STA2F4SP	Transparente	Niva	Blanco Branco	Silver Abrilantado	circular	Blanco Branco	Silver Abrilantado
L 66↔89,9	STA2F4SP		+ 40 €	454 €	504 €		419 €	461 €
L 90↔102	STA2F4SP			509 €	562 €		472 €	519 €
H 60↔195				516 €	572 €		477 €	525 €

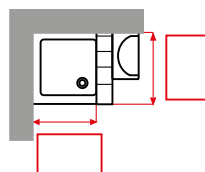
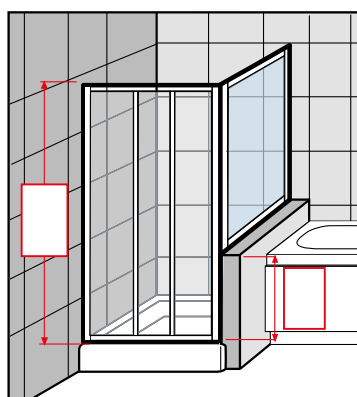
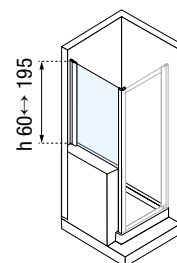

PARA MÁS OPCIONES DE PANELES FIJOS ESPECIALES, CONSULTAR LA TARIFA "ÁREA DE PROYECTOS"
PARA MAIS FIXOS ESPECIAIS, CONSULTAR A TARIFA "ÁREA DE PROYECTOS"
FIJOS DE ANCHO ESPECIAL. ALTURA DE 60 A 195 CM (ESPECIFICAR EN EL PEDIDO LA MEDIDA EXACTA)
FIXOS DE LARGURA ESPECIAL. ALTURA DE 60 A 195 CM (ESPECIFICAR NO PEDIDO A MEDIDA EXACTA)

Construcción del código: **Código** + **Cristales/acrílico** + **Perfiles** = Código completo del producto
Construção do código: **Código** + **Vidros/acrílico** + **Perfis** = Código completo do produto

STAR 2.0 F SPECIAL 5

PANELES FIJOS ESPECIALES
PAINÉLES FIXOS ESPECIAIS

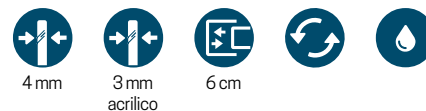

FIJACIÓN EN LÍNEA
FIXAÇÃO EM LINHA



PAREDES DIVISORIAS



FIJACIÓN A PARED LATERAL
FIXAÇÃO A PAREDE



EN LÍNEA SOBRE MURETE
EM LINHA SOBRE PAREDE

FIJACIÓN EN LÍNEA / FIXAÇÃO EM LINHA

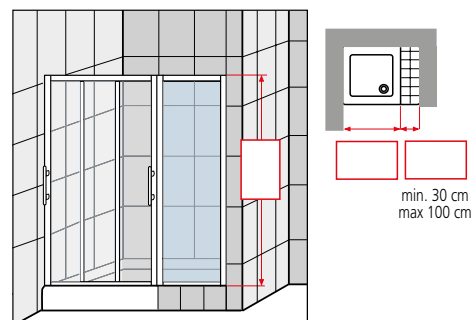

PAREDES DIVISORIAS

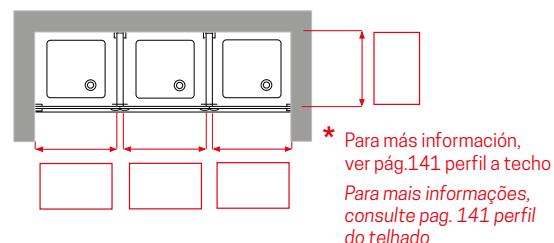
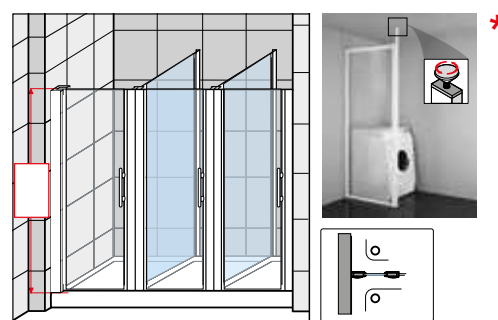

FIJACIÓN A PARED LATERAL / FIXAÇÃO A PAREDE

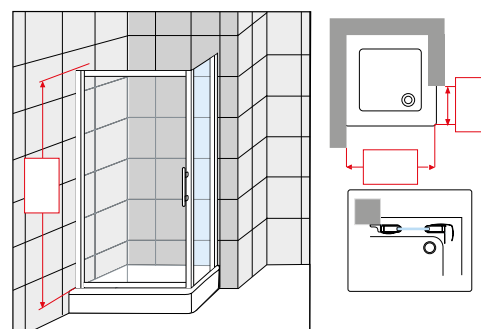

EN LÍNEA SOBRE MURETE / EM LINHA SOBRE PAREDE

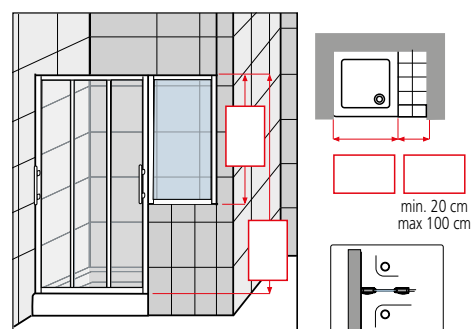

Medidas	Código	Selección Cristales Seleção Vidros		Selección de perfiles Seleção de perfis		selección acrílico Seleção acrílico	Selección de perfiles Seleção de perfis	
		1	11	A	B		A	B
		Transparente	Niva	Blanco Branco	Silver Abrillantado	circular	Blanco Branco	Silver Abrillantado

FIJACIÓN EN LÍNEA / FIXAÇÃO EM LINHA								
H 25	59,9	STA2F5SP			408 €	451 €	376 €	419 €
H 60	95,9	STA2F5SP			463 €	514 €	429 €	477 €
H 96	159,9	STA2F5SP	+ 40 €		492 €	546 €	456 €	504 €
H 160	189,9	STA2F5SP			523 €	578 €	482 €	535 €
H 190	200	STA2F5SP			562 €	620 €	519 €	572 €

FIJO LATERAL / FIXO LATERAL								
H 25	59,9	STA2F5SP			439 €	488 €	408 €	451 €
H 60	95,9	STA2F5SP			492 €	546 €	456 €	504 €
H 96	159,9	STA2F5SP	+ 40 €		523 €	578 €	482 €	535 €
H 160	189,9	STA2F5SP			562 €	620 €	519 €	572 €
H 190	200	STA2F5SP			590 €	652 €	546 €	604 €

FIJACIÓN A PARED LATERAL / FIXAÇÃO A PAREDE LATERAL								
H 25	59,9	STA2F5SP			470 €	519 €	435 €	482 €
H 60	95,9	STA2F5SP			523 €	578 €	482 €	535 €
H 96	159,9	STA2F5SP	+ 40 €		562 €	620 €	519 €	572 €
H 160	189,9	STA2F5SP			590 €	652 €	546 €	604 €
H 190	200	STA2F5SP			628 €	694 €	578 €	636 €

FIJOS DE ALTURA ESPECIAL. ANCHO DE 20 A 100 CM (ESPECIFICAR EN EL PEDIDO LA MEDIDA EXACTA)
FIXOS DE ALTURA ESPECIAL. LARGURA DE 20 A 100 CM (ESPECIFICAR NO PEDIDO A MEDIDA EXACTA)

DATOS TÉCNICOS / DADOS TÉCNICOS

COLORES PERFILES / CORES PERFÍS



Blanco
Branco
cod. D



Silver
Abrilantado
cod. B

CRISTAL TEMPLADO / VIDRO TEMPERADO 6 mm (Según norma Europea UNE EN 14428)

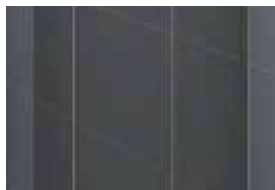

Transparente
cod. 1



Niva
cod. 11

SERIGRAFIA

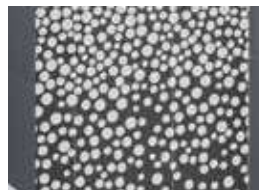

Punto
cod. 38

ACRILICO 3 mm



Circular
cod. 43

OPTIONAL

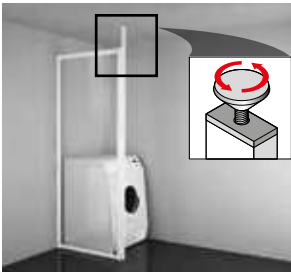

PERFIL A TECHO

- Perfil especial para fijación a techo para combinar al NSTARF5SP

Color Cores	Medidas	Código	Precio Preço
Blanco Branco	H 180 ↓ 265	SPA3102	122 €
Silver Abrilantado	H 180 ↓ 265	SPA3102	136 €

MEDIDAS QUE OCUPAN LOS PERFILES EN LA PARED / ESPAÇO QUE OCUPAN OS PERFÍS NA PAREDE

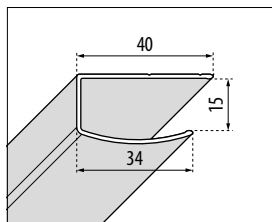

A PARED
A - R - 3A - F

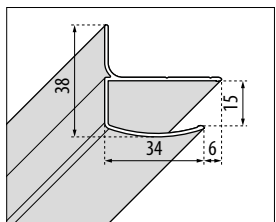

A PARED
2P - 3P - G - B - S - 2S

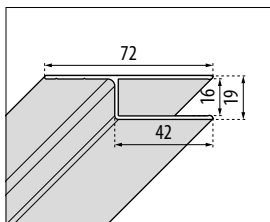

A PARED
todos los modelos

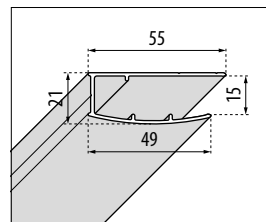

COMPENSADORES
todos los modelos

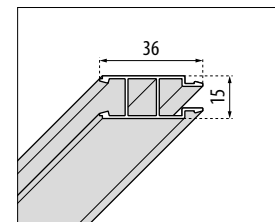

COMPENSADORES
para modelos A y 3A

Color / Cores	Código
Blanco/Branco	P01HAAST3-A
Silver/Abrilantado	P01HAAST3-B

Color / Cores	Código
Blanco/Branco	P01HAPCST3-A
Silver/Abrilantado	P01HAPCST3-B

Color / Cores	Código
Blanco/Branco	P01L215STL-A
Silver/Abrilantado	P01L215STL-B

Color / Cores	Código
Blanco/Branco	P01SACST3-A
Silver/Abrilantado	P01SACST3-B

Color / Cores	Código
Blanco/Branco	P05HAAST3-A
Silver/Abrilantado	P05HAAST3-B

TOMA DE MEDIDAS

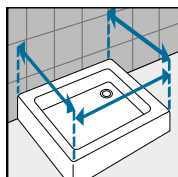
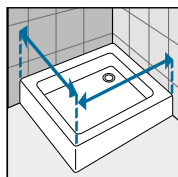

Tomar las medidas desde la pared hasta el borde externo del plato de ducha.

Medir a distância desde a parede até o rebordo externo da base de chuveiro.

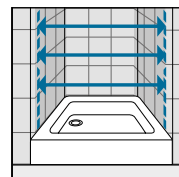
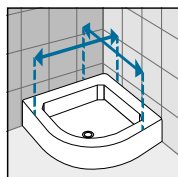

Tomar medidas de pared a pared, medir la parte baja, la central y la superior. Cursar el pedido con la medida más pequeña.

Medir a distância entre paredes, tem que tirar três medidas (inferior, superior e central) e utilizar a inferior. Encomendar pedido da medida mais pequena.

RIVIERA

SENCILLEZ Y VERSATILIDAD
DE USO.

SIMPLICIDADE E VERSATILIDADE
DE UTILIZAÇÃO.



◀
Altura 1900 mm



◀
Bogie deslizante con ruedas
Deslizador de bogie com
rodas



◀
Nuevo diseño esencial
Novo desenho essencial



Capaz de satisfacer las exigencias de espacio y confort gracias a sus numerosas configuraciones, la línea se caracteriza por la extrema fluidez de las puertas correderas, superiores a la media para un espesor de 3 mm; también es particular su altura, que alcanza los 190 cm y permite la combinación de importantes rociadores sin renunciar a la practicidad de uso. Disponible también como sobrepuerta con diferentes sistemas de apertura, transforma los ambientes más diversos con la facilidad de instalación en total estilo Novellini. Riviera 2.0 puede personalizarse en cristal transparente, Estampado C o con serigrafía Riviera; como alternativa, es posible montar la puerta en acrílico hielo.

Capaz de satisfazer as exigências de espaço e conforto graças às suas numerosas configurações, a linha caracteriza-se pela extrema fluidez das portas de correr, que estão acima da média para uma espessura de 3 mm; a sua altura é também particular, atingindo 190 cm e permitindo a combinação de chuveiros importantes sem sacrificar a praticidade de utilização. Também disponível como overtop com diferentes sistemas de abertura, transforma os mais diversos ambientes com a facilidade de instalação no estilo Novellini total. Riviera 2.0 pode ser personalizado em cristal transparente, Stampato C ou com serigrafia Riviera; alternativamente, é possível montar a porta em acrílico de gelo.



RIVIERA

RIVIERA A

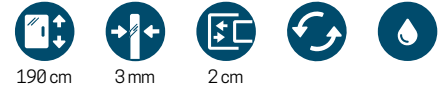

ANGULAR DE DOS PUERTAS CORREDERAS + DOS FIJOS
ANGULAR DE DUAS PORTS DE CORRER + DOS FIXOS

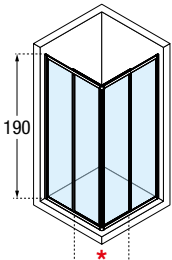

Medidas			Código	Selección Cristales Seleção Vidros			Selección de perfiles Seleção de perfis		selección acrílico Seleção acrílico	Selección de perfiles Seleção de perfis	
Medidas extensibilidad Medidas extensibilidade	Fijo frontal Fixo frontal	Entrada		1	6	55	A	B	20	A	B
A	F1	F2	*	Transparente	Estampado C	Serigrafía Riviera	Blanco Branco	Silver Abrrillatado	hielo	Blanco Branco	Silver Abrrillatado
62↔64	32	-	35				527 €	580 €		447 €	492 €
67↔69	34	-	40				540 €	596 €		461 €	508 €
77↔79	39	-	47				569 €	625 €		484 €	533 €
87↔89	44	-	54				597 €	656 €		509 €	560 €
97↔99	49	-	61				631 €	694 €		534 €	588 €
67↔69x87↔89	34	44	47				569 €	625 €		484 €	533 €
67↔69x97↔99	34	49	50				586 €	646 €		497 €	549 €
77↔79x97↔99	39	49	54				601 €	660 €		511 €	561 €

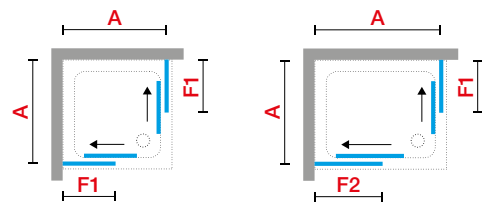

RIVIERA 2P



PUERTA DE DOS HOJAS: UNA CORREDERA + UNA FIJA Para instalar entre paredes o con fijo lateral RIVIERA F
RESGUARDO DE 2 FOLHAS: 1 DE CORRER + 1 FIXA Para instalar entre paredes ou com fijo lateral RIVIERA F

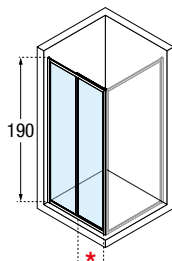

Medidas			Código	Selección Cristales Seleção Vidros			Selección de perfiles Seleção de perfis		selección acrílico Seleção acrílico	Selección de perfiles Seleção de perfis	
Medidas extensibilidad Medidas extensibilidade	Fijo frontal Fixo frontal	Entrada		1	6	55	A	B	20	A	B
A	F1	*		Transparente	Estampado C	Serigrafía Riviera	Blanco Branco	Silver Abrrillatado	hielo	Blanco Branco	Silver Abrrillatado
PUERTA / PORTA											
96↔100	48	41	RIV22P100-				498 €	550 €		426 €	469 €
116↔120	58	51	RIV22P120-				576 €	633 €		491 €	540 €

CRISTAL TEMPLADO VIDRO TEMPERADO



COLORES PERFILES CORES PERFÍS



RIVIERA G



MAMPARA DE DUCHA ABATIBLE DE UNA HOJA Para instalar entre paredes o con fijo lateral RIVIERA F

RESGUARDO DE DUCHE DE ABRIR DE UMA FOLHA Para instalar entre paredes ou com fixo lateral RIVIERA F



Medidas			Código	Selección Cristales Seleção Vidros			Selección de perfiles Seleção de perfis		selección acrílico Seleção acrílico	Selección de perfiles Seleção de perfis	
Medidas extensibilidad Medidas extensibilidade	Entrada	Espacio de apertura Espaço de abertura		1	6	55	A	B	20	A	B
A	*	B		Transparente	Estampado C	Serigrafía Riviera	Blanco Branco	Silver Abrillantado	hielo	Blanco Branco	Silver Abrillantado
68↔72	49	48	RIV2G70-				354 €	390 €		302 €	333 €
73↔77	54	53	RIV2G75-				363 €	400 €		310 €	341 €
78↔82	54	54	RIV2G80-	+ 40 €	+ 40 €		376 €	416 €		321 €	353 €
83↔87	59	59	RIV2G85-				382 €	422 €		326 €	359 €
88↔92	64	64	RIV2G90-				390 €	429 €		333 €	368 €

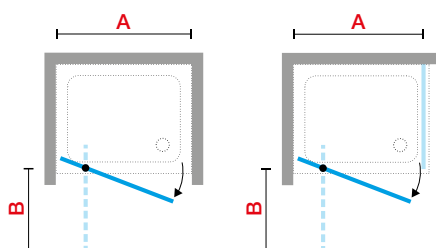
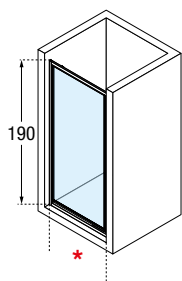

RIVIERA S



MAMPARA PLEGABLE DE DOS HOJAS Para instalar entre paredes o con fijo lateral RIVIERA F

RESGUARDO DESDOBRÁVEL DE DUAS FOLHAS Para instalar entre paredes ou com fixo lateral RIVIERA F



Medidas			Código	Selección Cristales Seleção Vidros			Selección de perfiles Seleção de perfis		selección acrílico Seleção acrílico	Selección de perfiles Seleção de perfis	
Medidas extensibilidad Medidas extensibilidade	Entrada	Espacio de apertura Espaço de abertura		1	6	55	A	B	20	A	B
A	*	B		Transparente	Estampado C	Serigrafía Riviera	Blanco Branco	Silver Abrillantado	hielo	Blanco Branco	Silver Abrillantado
66↔72	46	28	RIV2S70-				490 €	538 €		418 €	460 €
72↔78	52	31	RIV2S75-				517 €	570 €		440 €	487 €
78↔84	58	34	RIV2S80-	+ 40 €	+ 40 €		545 €	601 €		465 €	512 €
84↔90	64	37	RIV2S85-				575 €	631 €		490 €	538 €

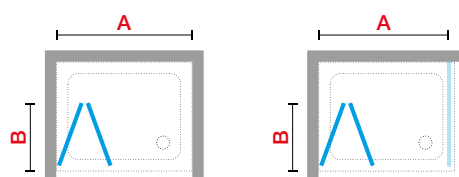
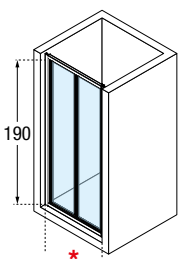

CRISTAL TEMPLADO VIDRO TEMPERADO



COLORES PERFILES CORES PERFIS



Construcción del código: **Código** + **Cristales/acrílico** + **Perfiles** = Código completo del producto
 Construção do código: **Código** + **Vidros/acrílico** + **Perfis** = Código completo do produto

RIVIERA 3P



MAMPARA DE TRES HOJAS CORREDERAS Para instalar entre paredes o con fijo lateral ved
RESGUARDO DE TRES FOLHAS DE CORRER Para instalar entre paredes ou com fijo lateral RIVIERA F



Medidas			Código	Selección Cristales Seleção Vidros			Selección de perfiles Seleção de perfis		selección acrílico Seleção acrílico	Selección de perfiles Seleção de perfis	
Medidas extensibilidad Medidas extensibilidade	Fijo frontal Fijo frontal	Entrada		1	6	55	A	B	20	A	B
A	F1	*		Transparente	Estampado C	Serigrafía Riviera	Blanco Branco	Silver Brillantado	hielo	Blanco Branco	Silver Brillantado
68↔72	236	37	RIV23P70-				496 €	545 €		423 €	465 €
73↔77	252	40	RIV23P75-				511 €	561 €		434 €	477 €
78↔82	268	43	RIV23P80-	+ 40 €	+ 40 €		524 €	577 €		447 €	492 €
83↔87	286	46	RIV23P85-				538 €	591 €		459 €	506 €
88↔92	302	49	RIV23P90-				553 €	608 €		471 €	518 €

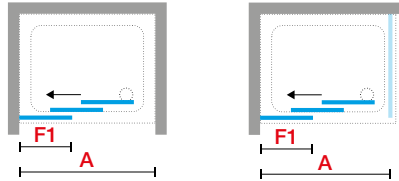
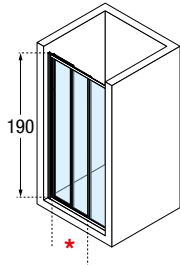

RIVIERA R



MAMPARA SEMICIRCULAR DE DOS PUERTAS CORREDERAS + DOS FIJOS
RESGUARDO PARA BASE SEMICIRCULAR COMPUESTO POR DUAS PORTAS DE CORRER



Medidas				Código	Selección Cristales Seleção Vidros		Selección de perfiles Seleção de perfis		selección acrílico Seleção acrílico	Selección de perfiles Seleção de perfis	
Medidas extensibilidad Medidas extensibilidade	Fijo frontal Fijo frontal	Entrada	Radio		1	6	A	B	20	A	B
A	F1	*	R		Transparente	Estampado C	Blanco Branco	Silver Brillantado	hielo	Blanco Branco	Silver Brillantado
78,5↔81,5	24	40	55	RIV2R80-			827 €	909 €		704 €	776 €
88,5↔91,5	34	54	55	RIV2R90-	+ 80 €		846 €	932 €		720 €	793 €

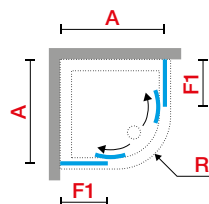
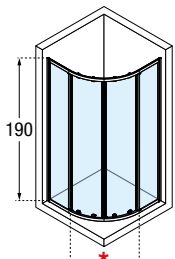

RIVIERA F



PANEL FIJO
PAINEL FIXO



Medidas	Código	Selección Cristales Seleção Vidros			Selección de perfiles Seleção de perfis		selección acrílico Seleção acrílico	Selección de perfiles Seleção de perfis	
		1	6	55	A	B		A	B
Medidas extensibilidad Medidas extensibilidade					Blanco Branco	Silver Brillantado	hielo	Blanco Branco	Silver Brillantado
F		Transparente	Estampado C	Serigrafía Riviera					
68↔72	RIV2F70-				249 €	273 €		212 €	233 €
73↔77	RIV2F75-				263 €	290 €		225 €	248 €
78↔82	RIV2F80-		+ 40 €	+ 40 €	278 €	305 €		236 €	260 €
83↔87	RIV2F85-				292 €	321 €		249 €	273 €
88↔92	RIV2F90-				305 €	337 €		260 €	288 €

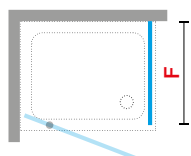
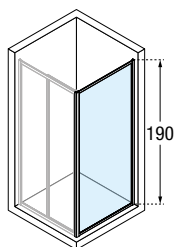

COLORES PERFILES CORES PERFÍS

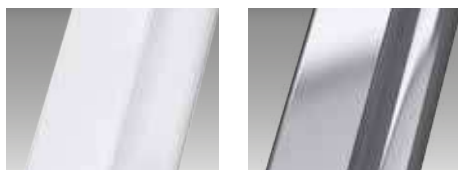

Blanco
cod. A

Silver
cod. B

CRISTAL TEMPLADO VIDRO TEMPERADO 3 mm

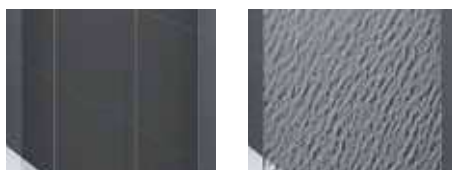

Transparente
cod. 1

Estampado C
cod. 6

SERIGRAFIA



Riviera
cod. 55

ACRILICO



Hielo
cod. 20

MEDIDAS QUE OCUPAN LOS PERFILES EN LA PARED / ESPAÇO QUE OCUPAN OS PERFÍS NA PAREDE

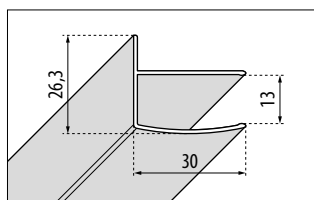

A PARED
RIVIERA A - G - 3P - 2P

Color / Cores	Código
Blanco/Branco	P01BC3MOST-A
Silver/Abrillantado	P01BC3MOST-B

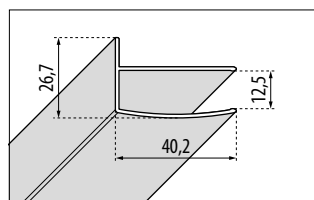

A PARED
RIVIERA S

Color / Cores	Código
Blanco/Branco	P01BC3SST-A
Silver/Abrillantado	P01BC3SST-B

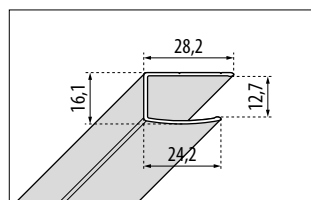

A PARED
RIVIERA R

Color / Cores	Código
Blanco/Branco	P01BCRST-A
Silver/Abrillantado	P01BCRST-B

TOMA DE MEDIDAS

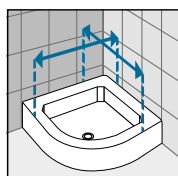
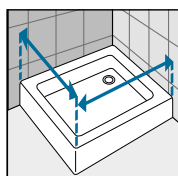

Tomar las medidas desde la pared hasta el borde externo del plato de ducha.
Medir a distância desde a parede até o rebordo externo da base de chuveiro.

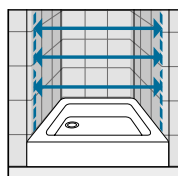

Tomar medidas de pared a pared, medir la parte baja, la central y la superior. Cursar el pedido con la medida más pequeña.
Medir a distância entre paredes, tem que tirar três medidas (inferior, superior e central) e utilizar a inferior. Encomendar pedido da medida mais pequena.

Construcción del código: **Código** + **Cristales/acrílico** + **Perfiles** = Código completo del producto
Construção do código: **Código** + **Vidros/acrílico** + **Perfis** = Código completo do produto

N180

BRILLO, ELEGANCIA
Y PERSONALIDAD
EN EL CUARTO DE BAÑO.

LUMINOSIDADE, ELEGÂNCIA
E PERSONALIDADE
NO AMBIENTE DA CASA DE BANHO.



◀ Bisagra de entrada/salida con bloqueo de apertura de 90° y mecanismo de cierre lento
Dobradiça de entrada/saída com fecho de abertura a 90° e mecanismo de fecho lento



◀ Tirador
Puxador



◀ Cierre con imanes ocultos
Fechamento com ímanes ocultos

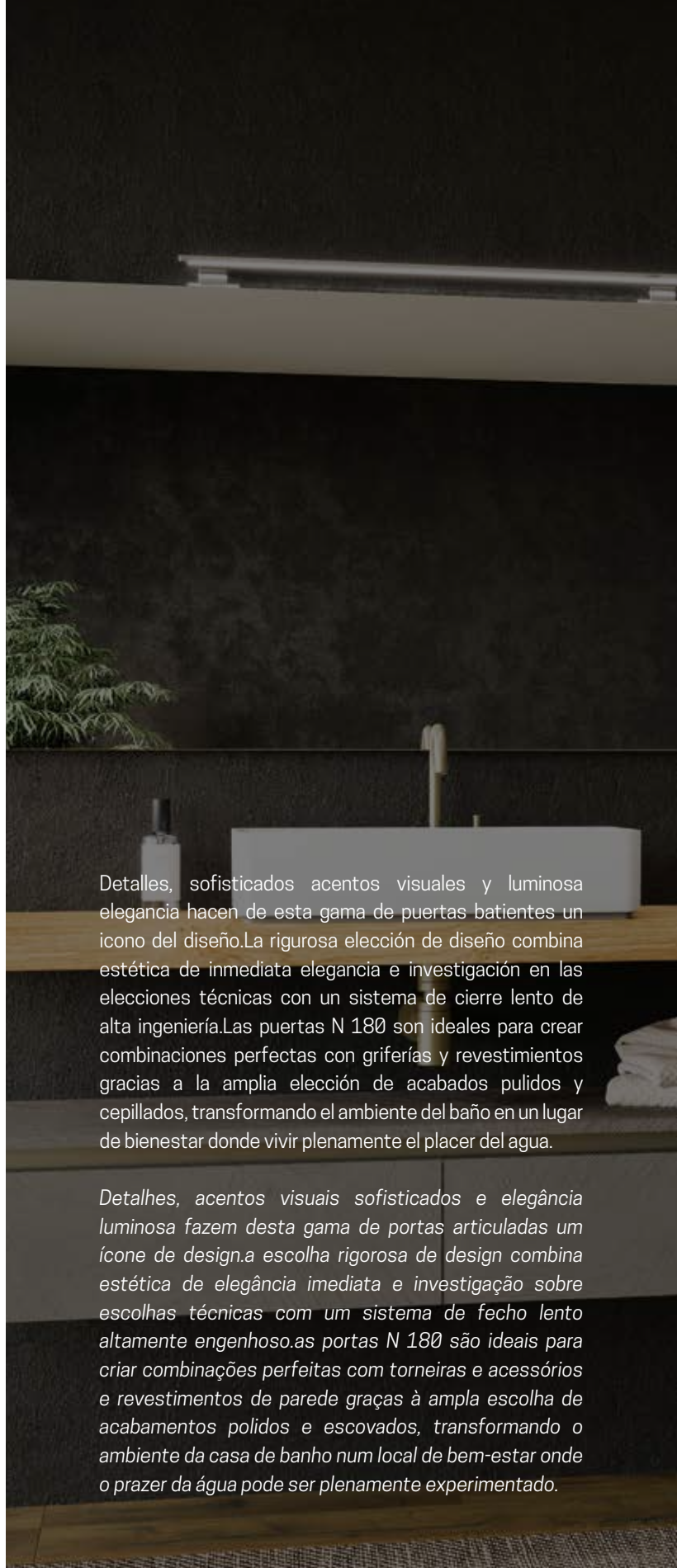

Detalles, sofisticados acentos visuales y luminosa elegancia hacen de esta gama de puertas batientes un icono del diseño. La rigurosa elección de diseño combina estética de inmediata elegancia e investigación en las elecciones técnicas con un sistema de cierre lento de alta ingeniería. Las puertas N 180 son ideales para crear combinaciones perfectas con griferías y revestimientos gracias a la amplia elección de acabados pulidos y cepillados, transformando el ambiente del baño en un lugar de bienestar donde vivir plenamente el placer del agua.

Detalhes, acentos visuais sofisticados e elegância luminosa fazem desta gama de portas articuladas um ícone de design. A escolha rigorosa de design combina estética de elegância imediata e investigação sobre escolhas técnicas com um sistema de fecho lento altamente engenhoso. As portas N 180 são ideais para criar combinações perfeitas com torneiras e acessórios e revestimentos de parede graças à ampla escolha de acabamentos polidos e escovados, transformando o ambiente da casa de banho num local de bem-estar onde o prazer da água pode ser plenamente experimentado.

TRATAMIENTOS / TRATAMENTOS





TRANSPARENTE / NOX SATINADO

N180

N180 G+F EN LÍNEA/EM LINHA



200 cm



8 mm



3 cm
puerta
porta



2 cm
fijo
fijo



Soft closing



MAMPARA DE UNA PUERTA ABATIBLE + FIJO EN LÍNEA RESGUARDO DE UNA PORTA ABATÍVELS + FIXO EM LINHA

Design Marco Pellici

Medidas					Código	Selección Cristales Seleção Vidros	Selección de perfiles Seleção de perfis						
Medidas extensibilidad Medidas extensibilidade con fijo com fijo	Medidas extensibilidad para platos a ras de suelo	Fijo panel en línea Fijo painel em linha	Entrada	Espacio de apertura Espaço de abertura			1	U	B	K	H	O M L	P R Q N Z
A	G	F1	*	B		Transparente	Blanco mate Branco mate	Silver Abrillantado	Cromo	Negro mate	Oro brillo Oro rosa brillo Cromo negro brillo	Oro satinado Oro rosa satinado Bronce satinado Cromo negro satinado Inox satinado	

FRONTAL PUERTA + FIJO EN LINEA / PORTA + FIXO EM LINHA											
97↔100	95,9↔98,9	21↔23	61	60	N180GFL98-	1.208 €	1.336 €	1.473 €	1.473 €	1.871 €	1.738 €
99↔102	97,9↔100,9	23↔25	61	60	N180GFL100-	1.208 €	1.336 €	1.473 €	1.473 €	1.871 €	1.738 €
117↔120	115,9↔118,9	21↔23	81	80	N180GFL118-	1.336 €	1.473 €	1.622 €	1.622 €	2.019 €	1.887 €
119↔122	117,9↔120,9	23↔25	81	80	N180GFL120-	1.336 €	1.473 €	1.622 €	1.622 €	2.019 €	1.887 €
137↔140	135,9↔138,9	41↔43	81	80	N180GFL138-	1.458 €	1.606 €	1.770 €	1.770 €	2.168 €	2.035 €
139↔142	137,9↔140,9	43↔45	81	80	N180GFL140-	1.458 €	1.606 €	1.770 €	1.770 €	2.168 €	2.035 €
157↔160	155,9↔158,9	61↔63	81	80	N180GFL158-	1.521 €	1.680 €	1.855 €	1.855 €	2.253 €	2.120 €
159↔162	157,9↔160,9	63↔65	81	80	N180GFL160-	1.521 €	1.680 €	1.855 €	1.855 €	2.253 €	2.120 €
177↔180	175,9↔178,9	81↔83	81	80	N180GFL178-	1.595 €	1.760 €	1.940 €	1.940 €	2.337 €	2.205 €
179↔182	177,9↔180,9	83↔85	81	80	N180GFL180-	1.595 €	1.760 €	1.940 €	1.940 €	2.337 €	2.205 €
H 200 L 100↔180					ESPECIAL N180GFLSP	2.016 €	2.226 €	2.455 €	2.455 €	2.852 €	2.720 €

PANEL FIJO LATERAL / PAINEL FIXO LATERAL											
F											
77,5↔79,5	76↔78				N180F80-	583 €	641 €	710 €	710 €	827 €	784 €
87,5↔89,5	86↔88				N180F90-	663 €	731 €	806 €	806 €	922 €	880 €
97,5↔99,5	96↔98				N180F100-	721 €	795 €	875 €	875 €	991 €	949 €
117,5↔119,5	116↔118				N180F120-	853 €	938 €	1.037 €	1.037 €	1.153 €	1.111 €
H 200 L 80↔120					ESPECIAL N180FSP	1.024 €	1.126 €	1.244 €	1.244 €	1.361 €	1.319 €

OPCIONAL

KIT BARRA EN "T" Para instalar con dos fijos en angulo / instalar com dois ângulos fijos											
	Código	Selección de perfiles / Seleção de perfis									
		U	B	K	H	O M L	P R Q N Z				
		Blanco mate Branco mate	Silver Abrillantado	Cromo	Negro mate	Oro brillo Oro rosa brillo Cromo negro brillo	Oro satinado Oro rosa satinado Bronce satinado Cromo negro satinado Inox satinado				
	R80BOORT150-	117 €	133 €	148 €	148 €	193 €	178 €				

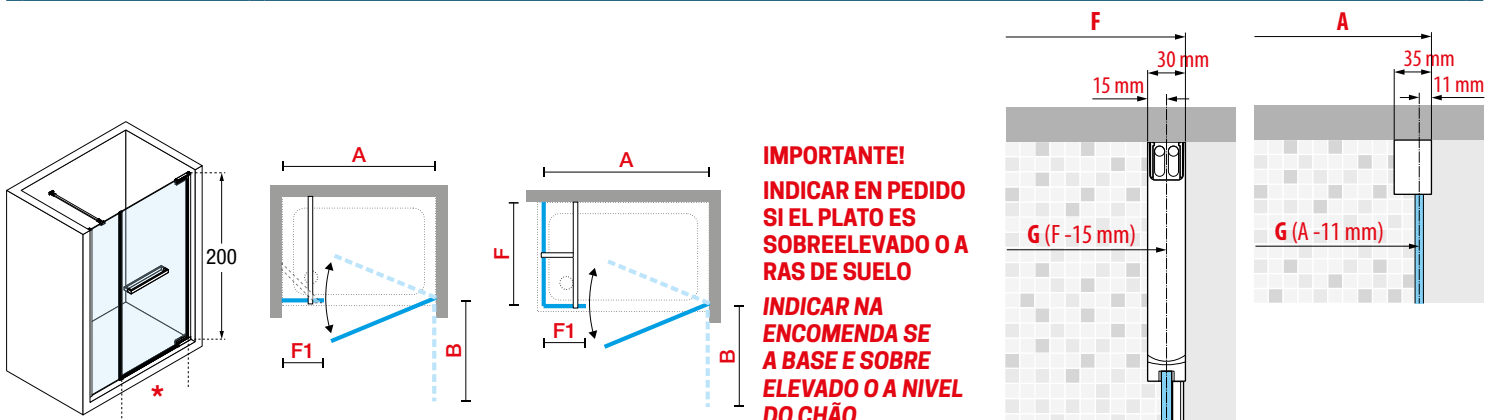



TRASPARENTE / BRONCE SATINADO

CRISTAL TEMPLADO / VIDRO TEMPERADO

Transparente
cod 1

COLORES PERFILES / CORES PERFÍS

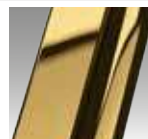
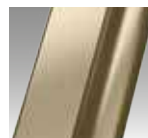
Blanco mate
Branco mate
cod USilver
Abrillantado
cod BCromo
cod KNegro mate
cod HOro brillo
cod OOro rosa brillo
cod MCromo negro
brillo
cod LOro satinado
cod POro rosa
satinado
cod RCromo negro
satinado
cod NBronce
satinado
cod QInox
satinado
cod Z

N180 1B



PUERTA DE UNA HOJA ABATIBLE RESGUADO PARA BASE COMPOSTO POR UNA PORTA ABATIVEL E

Design Marco Pellici

Medidas			Código	Selección Cristales Seleção Vidros	Selección de perfiles Seleção de perfis					
Medidas extensibilidad Medidas extensibilidade	Entrada	Espacio de apertura Espaço de abertura			1	U	B	K	H	O M L
A1	*	B		Transparente	Blanco mate Branco mate	Silver Abrrillatado	Cromo	Negro mate	Oro brillo Oro rosa brillo Cromo negro brillo	Oro satinado Oro rosa satinado Bronce satinado Cromo nero satinado Inox satinado
77,5↔79	60	59	N1801B79-		954 €	1.049 €	1.155 €	1.155 €	1.526 €	1.420 €
78,5↔80	61	60	N1801B80-		954 €	1.049 €	1.155 €	1.155 €	1.526 €	1.420 €
87,5↔89	70	69	N1801B89-		1.039 €	1.145 €	1.261 €	1.261 €	1.632 €	1.526 €
88,5↔90	71	70	N1801B90-		1.039 €	1.145 €	1.261 €	1.261 €	1.632 €	1.526 €
97,5↔99	80	79	N1801B99-		1.124 €	1.240 €	1.367 €	1.367 €	1.738 €	1.632 €
98,5↔100	81	80	N1801B100-		1.124 €	1.240 €	1.367 €	1.367 €	1.738 €	1.632 €
H 200 L 80↔100		ESPECIAL	N1801BSP		1.456 €	1.603 €	1.768 €	1.768 €	2.139 €	2.033 €

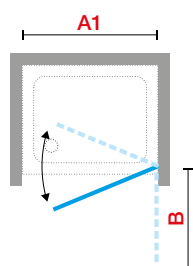
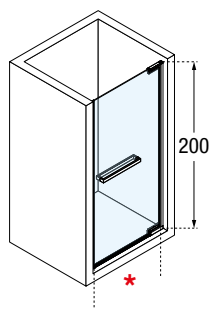



TRANSPARENTE / ORO ROSA SATINADO

CRISTAL TEMPLADO / VIDRO TEMPERADO



Transparente
cod 1

COLORES PERFILES / CORES PERFÍS



Blanco mate
Branco mate
cod U



Silver
Abrillantado
cod B



Cromo
cod K



Negro mate
cod H



Oro brillo
cod O



Oro rosa brillo
cod M



Cromo negro
brillo
cod. L



Oro satinado
cod. P



Oro rosa
satinado
cod. R



Cromo negro
satinado
cod. N

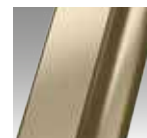

Bronce
satinado
cod. Q



Inox
satinado
cod. Z

N180 G+F



PUERTA DE UNA HOJA ABATIBLE + FIJO
PORTA DE UNA FOLHA ABATÍVEL + FIXO
 Design Marco Pellici

Medidas					Código	Selección Cristales Seleção Vidros	Selección de perfiles Seleção de perfis					
Medidas extensibilidad Medidas extensibilidade	Medidas extensibilidad para platos a ras de suelo	Panel fijo lateral Painel fixo lateral	Entrada	Espacio de apertura Espaço de abertura		1	U	B	K	H	O M L	P R Q N Z
A	G	F	*	B		Transparente	Blanco mate Branco mate	Silver Abrillantado	Cromo	Negro mate	Oro brillo Oro rosa brillo Cromo negro brillo	Oro satinado Oro rosa satinado Bronce satinado Cromo negro satinado Inox satinado

PUERTA / PORTA											
78↔79,5	76,9↔78,4		61	60	N180G80-	864 €	954 €	1.049 €	1.049 €	1.394 €	1.288 €
88↔89,5	86,9↔88,4		71	70	N180G90-	954 €	1.049 €	1.155 €	1.155 €	1.500 €	1.394 €
98↔99,5	96,9↔98,4		81	80	N180G100-	1.039 €	1.145 €	1.261 €	1.261 €	1.606 €	1.500 €
H 200 L 80↔100			ESPECIAL		N180GSP	1.348 €	1.488 €	1.641 €	1.641 €	1.985 €	1.879 €

FIJO PANEL / FIXO PAINEL											
	76,5↔78	78↔79,5	-	-	N180FG80-	578 €	636 €	700 €	700 €	753 €	726 €
	86,5↔88	88↔89,5	-	-	N180FG90-	599 €	663 €	731 €	731 €	784 €	758 €
	96,5↔98	98↔99,5	-	-	N180FG100-	631 €	694 €	763 €	763 €	816 €	790 €
	116,5↔118	118↔119,5	-	-	N180FG120-	678 €	747 €	827 €	827 €	880 €	853 €
H 200 L 80↔120			ESPECIAL		N180FGSP	814 €	897 €	992 €	992 €	1.045 €	1.019 €

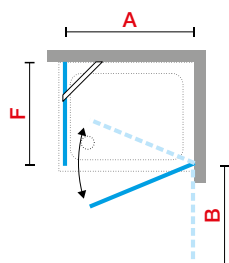
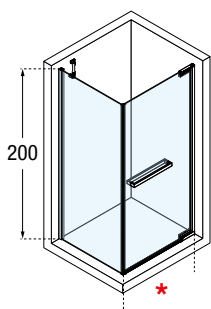

IMPORTANTE!
INDICAR EN PEDIDO SI EL PLATO ES SOBREELEVADO O A RAS DE SUELO
INDICAR NA ENCOMENDA SE A BASE E SOBRE ELEVADO O A NIVEL DO CHÃO

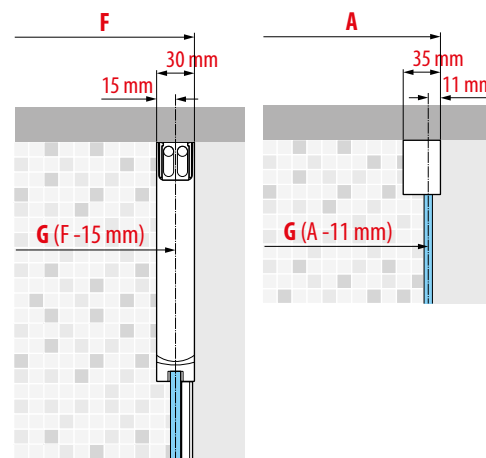



TRANSPARENTE / ORO BRILLO

CRISTAL TEMPLADO / VIDRO TEMPERADO

Transparente
cod. 1

COLORES PERFILES / CORES PERFÍS

Blanco mate
Branco mate
cod. USilver
Abrillantado
cod. BCromo
cod. KNegro mate
cod. HOro brillo
cod. OOro rosa brillo
cod. MCromo negro
brillo
cod. LOro satinado
cod. POro rosa
satinado
cod. RCromo negro
satinado
cod. NBronce
satinado
cod. QInox
satinado
cod. Z

DATOS TÉCNICOS / DADOS TÉCNICOS

COLORES PERFILES / CORES PERFÍS



Blanco mate
Branco mate
cod. U



Silver
Abrillantado
cod. B



Cromo
cod. K



Negro mate
cod. H

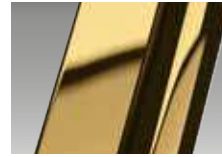

Oro
brillo
cod. O



Oro rosa
brillo
cod. M



Cromo
negro brillo
cod. L



Oro
satinado
cod. P

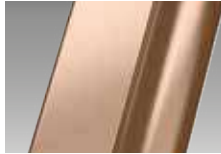

Oro rosa satinado
cod. R



Cromo negro
satinado
cod. N

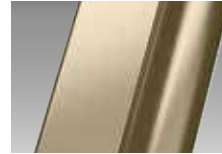

Bronce
satinado
cod. Q



Inox
satinado
cod. Z

CRISTAL TEMPLADO / VIDRO TEMPERADO 8 mm (Según norma Europea UNE EN 14428)



Transparente
cod. 1



MEDIDAS QUE OCUPAN LOS PERFILES EN LA PARED / ESPAÇO QUE OCUPAN OS PERFÍS NA PAREDE

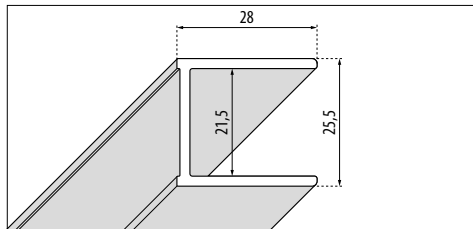

A PARED
N180 1B - G - GFL

Altura	Color perfil Cores perfil	Código	Precio Preço
1999	Blanco / Branco	P01DN1BGST-U	116 €
	Silver / Brillantado	P01DN1BGST-B	128 €
	Cromo	P01DN1BGST-K	141 €
	Negro mate	P01DN1BGST-H	141 €
	Inox satinado	P01DN1BGST-Z	170 €
	Oro brillo	P01DN1BGST-O	184 €
	Oro satinado	P01DN1BGST-P	170 €
	Bronzo satinado	P01DN1BGST-Q	170 €
	Cromo negro brillo	P01DN1BGST-L	184 €
	Cromo negro satinado	P01DN1BGST-N	170 €
	Oro rosa brillo	P01DN1BGST-M	184 €
	Oro rosa satinado	P01DN1BGST-R	170 €

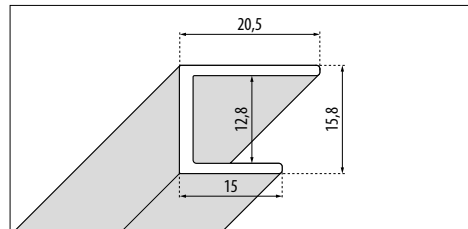

A PARED
N180 1B - lado del magneto

Altura	Color perfil Cores perfil	Código	Precio Preço
1998	Blanco / Branco	P04DN1BST-U	100 €
	Silver / Brillantado	P04DN1BST-B	110 €
	Cromo	P04DN1BST-K	121 €
	Negro mate	P04DN1BST-H	121 €
	Inox satinado	P04DN1BST-Z	146 €
	Oro brillo	P04DN1BST-O	158 €
	Oro satinado	P04DN1BST-P	146 €
	Bronzo satinado	P04DN1BST-Q	146 €
	Cromo negro brillo	P04DN1BST-L	158 €
	Cromo negro satinado	P04DN1BST-N	146 €
	Oro rosa brillo	P04DN1BST-M	158 €
	Oro rosa satinado	P04DN1BST-R	146 €

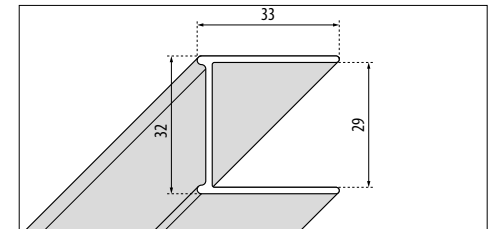

A PARED
N180 F lateral

Altura	Color perfil Cores perfil	Código	Precio Preço
1999	Blanco / Branco	P01BXMOST-U	122 €
	Silver / Brillantado	P01BXMOST-B	135 €
	Cromo	P01BXMOST-K	149 €
	Negro mate	P01BXMOST-H	149 €
	Inox satinado	P01BXMOST-Z	179 €
	Oro brillo	P01BXMOST-O	194 €
	Oro satinado	P01BXMOST-P	179 €
	Bronzo satinado	P01BXMOST-Q	179 €
	Cromo negro brillo	P01BXMOST-L	194 €
	Cromo negro satinado	P01BXMOST-N	179 €
	Oro rosa brillo	P01BXMOST-M	194 €
	Oro rosa satinado	P01BXMOST-R	179 €

TOMA DE MEDIDAS

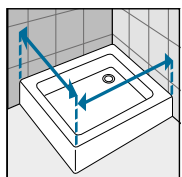

Tomar las medidas desde la pared hasta el borde externo del plato de ducha.
Medir a distância desde a parede até o rebordo externo da base de chuveiro.

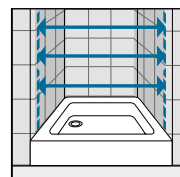

Tomar medidas de pared a pared, medir la parte baja, la central y la superior. Cursar el pedido con la medida más pequeña.
Medir a distância entre paredes, tem que tirar três medidas (inferior, superior e central) e utilizar a inferior. Encomendar pedido da medida mais pequena.



TRANSPARENTE / CROMO NEGRO BRILLO





YOUNG PLUS

EL ESPESOR DE LA
FIABILIDAD.
*A ESPESSURA DA
CONFIABILIDADE.*



◀
Perfileria con imán
Perfis com íman

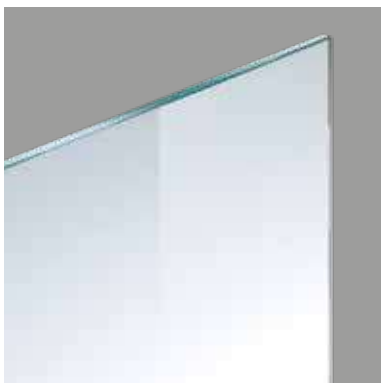

◀
Espesor del cristal 8 mm
Espessura do vidro 8 mm



◀
Bisagras de metal cromado
con sistema de auto-elevación
*Dobradiça de metal cromo com
sistema de auto elevação*



La excelencia para mamparas de 8 mm de espesor. La nueva Young Plus con la versión en 8 mm de cristal templado, proporciona una mayor estabilidad y seguridad. La transparencia del cristal se combina con el minimalismo de los nuevos perfiles de cierre magnético. La respuesta para quien desea lo mejor en su baño.

A excelência para resguardos de 8 mm de espessura. O novo Young Plus, com a versão de 8 mm de vidro temperado, proporciona maior estabilidade e segurança. A transparência do vidro é combinada com o minimalismo dos novos perfis magnéticos de fechamento. A resposta para quem deseja o melhor na sua casa de banho.

TRATAMIENTOS / TRATAMENTOS





YOUNG PLUS

YOUNG PLUS G+F EN LÍNEA/EM LINHA



MAMPARA DE UNA PUERTA ABATIBLE + FIJO EN LÍNEA
RESGUARDO DE UNA PORTA ABATÍVELS + FIXO EM LINHA

Medidas				Código	Derecha Direita	Izquierda Esquerda	Selección Cristales Seleção Vidros		Selección de perfiles Seleção de perfis				
Medidas extensibilidad Medidas extensibilidade	Fijo panel en línea Fixo painel em linha	Entrada	Espacio de apertura Espaço de abertura		D-	S-	1	44	U	B	K	H	Z
A	F1	*	B				Transparente	banda satinada	Blanco mate Branco mate	Silver Abrelantado	Cromo	Negro mate	Inox satinado
FRONTAL PUERTA + FIJO EN LINEA REVERSIBLE													
97-101	33	58	59	YPLUSGFL97-					905 €	978 €	978 €	1.173 €	1.107 €
103-107	33	64	65	YPLUSGFL103-					973 €	1.071 €	1.071 €	1.285 €	1.212 €
107↔111	33	68	69	YPLUSGFL107-					973 €	1.071 €	1.071 €	1.285 €	1.212 €
114↔118	40	68	69	YPLUSGFL114-					995 €	1.096 €	1.096 €	1.315 €	1.241 €
117↔121	43	68	69	YPLUSGFL117-					995 €	1.096 €	1.096 €	1.315 €	1.241 €
134↔138	50	78	79	YPLUSGFL134-					1.057 €	1.163 €	1.163 €	1.395 €	1.316 €
137↔141	53	78	79	YPLUSGFL137-	-	-		-	1.115 €	1.227 €	1.227 €	1.472 €	1.389 €
147↔151	63	78	79	YPLUSGFL147-					1.147 €	1.261 €	1.261 €	1.514 €	1.428 €
154↔158	70	78	79	YPLUSGFL154-					1.163 €	1.282 €	1.282 €	1.538 €	1.451 €
157↔161	63	88	89	YPLUSGFL157-					1.180 €	1.299 €	1.299 €	1.558 €	1.470 €
164↔168	70	88	89	YPLUSGFL164-					1.189 €	1.307 €	1.307 €	1.568 €	1.479 €
167↔171	73	88	89	YPLUSGFL167-					1.196 €	1.317 €	1.317 €	1.579 €	1.490 €
177↔181	83	88	89	YPLUSGFL177-					1.211 €	1.333 €	1.333 €	1.600 €	1.509 €
H 140↔220 L 70↔200		ESPECIAL		YPLUSGFLSP	-	-		-	1.678 €	1.847 €	1.847 €	2.215 €	2.090 €

FRONTAL PUERTA + FIJO EN LINEA NO REVERSIBLE													
							1	44	U	B	K	H	Z
97-101	33	58	59	YPLUSGFL97	D-	S-			837 €	905 €	978 €	978 €	1.173 €
103-107	33	64	65	YPLUSGFL103	D-	S-			884 €	973 €	1.071 €	1.071 €	1.285 €
107↔111	33	68	69	YPLUSGFL107	D-	S-			884 €	973 €	1.071 €	1.071 €	1.285 €
114↔118	40	68	69	YPLUSGFL114	D-	S-			904 €	995 €	1.096 €	1.096 €	1.315 €
117↔121	43	68	69	YPLUSGFL117	D-	S-			904 €	995 €	1.096 €	1.096 €	1.315 €
134↔138	50	78	79	YPLUSGFL134	D-	S-			959 €	1.057 €	1.163 €	1.163 €	1.395 €
137↔141	53	78	79	YPLUSGFL137	D-	S-	-	+ 40 €	1.014 €	1.115 €	1.227 €	1.227 €	1.472 €
147↔151	63	78	79	YPLUSGFL147	D-	S-			1.041 €	1.147 €	1.261 €	1.261 €	1.514 €
154↔158	70	78	79	YPLUSGFL154	D-	S-			1.057 €	1.163 €	1.282 €	1.282 €	1.538 €
157↔161	63	88	89	YPLUSGFL157	D-	S-			1.073 €	1.180 €	1.299 €	1.299 €	1.558 €
164↔168	70	88	89	YPLUSGFL164	D-	S-			1.080 €	1.189 €	1.307 €	1.307 €	1.568 €
167↔171	73	88	89	YPLUSGFL167	D-	S-			1.087 €	1.196 €	1.317 €	1.317 €	1.579 €
177↔181	83	88	89	YPLUSGFL177	D-	S-			1.101 €	1.211 €	1.333 €	1.333 €	1.600 €

BARRA DE SUJECIÓN A PARED DE 100 CM INCLUIDA

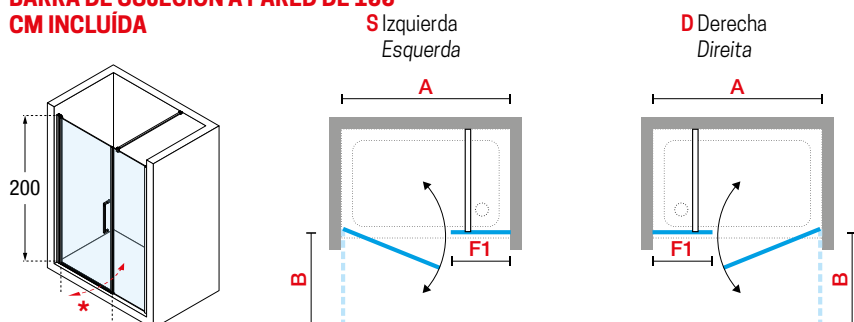

OPCIONAL

JUNTA HORIZONTAL INFERIOR PARA INSTALACIONES SIN KIT ESTANCO

Código	Precio / Preço
R55SPBOA01-TR	46 €



CRISTAL TEMPLADO / VIDRO TEMPERADO



Transparente
cod 1



Banda satinada
cod 44

COLORES PERFILES / CORES PERFÍS



Blanco
Branco
cod. D

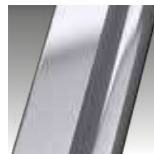

Silver
Abrillantado
cod. B



Cromo
cod. K



Negro mate
cod H



Inox satinado
cod Z

YOUNG PLUS 1B



MAMPARA DE UNA PUERTA ABATIBLE
RESGUARDO DE UMA FOLHA ABATÍVEL

Medidas			Código	Selección Cristales Seleção Vidros		Selección de perfiles Seleção de perfis				
Medidas extensibilidad Medidas extensibilidade	Entrada	Espacio de apertura Espaço de abertura		1	44	U	B	K	H	Z
Entre paredes				Transparente	banda satinada	Blanco mate Branco mate	Silver Abrilantado	Cromo	Negro mate	Inox satinado
A1	*	B								
77↔81	68	69	YPLUS1B77-			721 €	795 €	877 €	877 €	1.052 €
82↔86	73	74	YPLUS1B82-			737 €	810 €	893 €	893 €	1.071 €
87↔91	78	79	YPLUS1B87-		+ 40 €	750 €	827 €	908 €	908 €	1.090 €
92↔96	83	84	YPLUS1B92-			765 €	842 €	926 €	926 €	1.112 €
97↔101	88	89	YPLUS1B97-			779 €	856 €	942 €	942 €	1.131 €
H 140↔220 L 60↔120	ESPECIAL		YPLUS1BSP		-	989 €	1.089 €	1.198 €	1.198 €	1.437 €

OPCIONAL



JUNTA HORIZONTAL INFERIOR
 PARA INSTALACIONES SIN KIT
 ESTANCO

Código	Precio / Preço
R55SPBOM01-TR	46 €

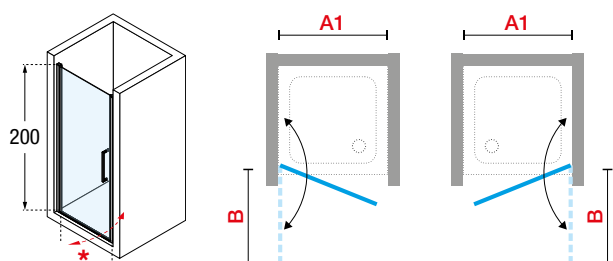



CRISTAL TEMPLADO / VIDRO TEMPERADO



Transparente
cod 1



Banda satinada
cod 44

COLORES PERFILES / CORES PERFÍS



Blanco
Branco
cod. D

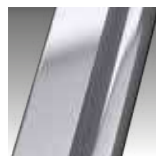

Silver
Abrillantado
cod. B



Cromo
cod. K



Negro mate
cod H



Inox satinado
cod Z

YOUNG PLUS G+F

PUERTA DE UNA HOJA ABATIBLE + FIJO
PORTA DE UNA FOLHA ABATÍVEL + FIXO



200 cm



8 mm



2 cm



Reversible
puerta
transparente



Non
reversible
fijo banda
satinada



Medidas				Código	Derecha	Izquierda	Selección Cristales		Selección de perfiles				
Medidas extensibilidad	Medidas extensibilidad	Entrada	Espacio de apertura		Direita	Esquerda	Selecção	Vidros	Selecção de perfis				
Medidas extensibilidad	Medidas para platos a ras de suelo				Espaço de abertura	D-	S-	1	44	U	B	K	H
A	G	*	B										
							Transparente	banda satinada	Blanco mate	Silver Abrillan-tado	Cromo	Negro mate	Inox satinado

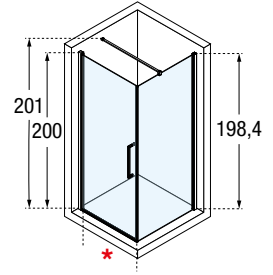

PUERTA REVERSIBLE / PORTA REVERSÍVEL													
76↔78	74,4↔76,4	67	68	YPLUSG76-					565€	622€	687€	687€	824€
77↔79	75,4↔77,4	68	69	YPLUSG77-					596€	654€	719€	719€	862€
79↔81	77,4↔79,4	70	71	YPLUSG79-					596€	654€	719€	719€	862€
81↔83	79,4↔81,4	72	73	YPLUSG81-					596€	654€	719€	719€	862€
83↔85	81,4↔83,4	74	75	YPLUSG83-					596€	654€	719€	719€	862€
85↔87	83,4↔85,4	76	77	YPLUSG85-					596€	654€	719€	719€	862€
87↔89	85,4↔87,4	78	79	YPLUSG87-					596€	654€	719€	719€	862€
89↔91	87,4↔89,4	80	81	YPLUSG89-	-	-		+ 40€	620€	686€	753€	753€	903€
91↔93	89,4↔91,4	82	83	YPLUSG91-					620€	686€	753€	753€	903€
93↔95	91,4↔93,4	84	85	YPLUSG93-					620€	686€	753€	753€	903€
95↔97	93,4↔95,4	86	87	YPLUSG95-					620€	686€	753€	753€	903€
97↔99	95,4↔97,4	88	89	YPLUSG97-					620€	686€	753€	753€	903€
99↔101	97,4↔99,4	90	91	YPLUSG99-					651€	716€	790€	790€	948€
101↔103	99,4↔101,4	92	93	YPLUSG101-					651€	716€	790€	790€	948€
103↔105	101,4↔103,4	94	95	YPLUSG103-					651€	716€	790€	790€	948€
H 140↑220			ESPECIAL	YPLUSGSP	-	-			810€	893€	983€	983€	1.179€
L 60↔120													

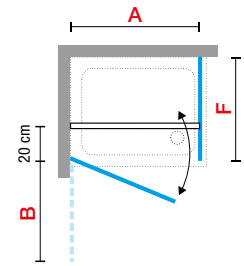

BARRA DE 150 CM. INCLUIDA

FIJO LATERAL REVERSIBLE / FIXO REVERSÍVEL													
67↔69	65,4↔67,4			YPLUSFG67-			1		527€	567€	615€	615€	738€
69↔71	67,4↔69,4			YPLUSFG69-					527€	567€	615€	615€	738€
76↔78	74,4↔76,4			YPLUSFG76-					541€	597€	655€	655€	785€
77↔79	75,4↔77,4			YPLUSFG77-					541€	597€	655€	655€	785€
79↔81	77,4↔79,4			YPLUSFG79-					541€	597€	655€	655€	785€
81↔83	79,4↔81,4			YPLUSFG81-					541€	597€	655€	655€	785€
83↔85	81,4↔83,4			YPLUSFG83-					571€	629€	693€	693€	832€
85↔87	83,4↔85,4			YPLUSFG85-					571€	629€	693€	693€	832€
87↔89	85,4↔87,4			YPLUSFG87-					571€	629€	693€	693€	832€
89↔91	87,4↔89,4			YPLUSFG89-	-	-			571€	629€	693€	693€	832€
91↔93	89,4↔91,4			YPLUSFG91-					571€	629€	693€	693€	832€
93↔95	91,4↔93,4			YPLUSFG93-					571€	629€	693€	693€	832€
95↔97	93,4↔95,4			YPLUSFG95-					571€	629€	693€	693€	832€
97↔99	95,4↔97,4			YPLUSFG97-					604€	665€	735€	735€	881€
99↔101	97,4↔99,4			YPLUSFG99-					604€	665€	735€	735€	881€
101↔103	99,4↔101,4			YPLUSFG101-					604€	665€	735€	735€	881€
103↔105	101,4↔103,4			YPLUSFG103-					604€	665€	735€	735€	881€
117↔119	115,4↔117,4			YPLUSFG117-					638€	689€	745€	745€	894€
119↔121	117,4↔119,4			YPLUSFG119-					638€	689€	745€	745€	894€
H 140↑220			ESPECIAL	YPLUSFGSP	-	-			787€	868€	956€	956€	1.147€
L 20↔120													

OPCIONAL



JUNTA HORIZONTAL INFERIOR
 PARA INSTALACIONES SIN KIT ESTANCO

Código	Precio Precio
R55SPBOM01-TR	46 €

FIJO LATERAL NO REVERSIBLE / FIXO NON REVERSÍVEL													
67↔69	65,4↔67,4			YPLUSFG67	D-	S-		44	527€	567€	615€	615€	738€
69↔71	67,4↔69,4			YPLUSFG69	D-	S-			527€	567€	615€	615€	738€
76↔78	74,4↔76,4			YPLUSFG76	D-	S-			541€	597€	655€	655€	785€
77↔79	75,4↔77,4			YPLUSFG77	D-	S-			541€	597€	655€	655€	785€
79↔81	77,4↔79,4			YPLUSFG79	D-	S-			541€	597€	655€	655€	785€
81↔83	79,4↔81,4			YPLUSFG81	D-	S-			541€	597€	655€	655€	785€
83↔85	81,4↔83,4			YPLUSFG83	D-	S-			571€	629€	693€	693€	832€
85↔87	83,4↔85,4			YPLUSFG85	D-	S-			571€	629€	693€	693€	832€
87↔89	85,4↔87,4			YPLUSFG87	D-	S-			571€	629€	693€	693€	832€
89↔91	87,4↔89,4			YPLUSFG89	D-	S-		+ 40€	571€	629€	693€	693€	832€
91↔93	89,4↔91,4			YPLUSFG91	D-	S-			571€	629€	693€	693€	832€
93↔95	91,4↔93,4			YPLUSFG93	D-	S-			571€	629€	693€	693€	832€
95↔97	93,4↔95,4			YPLUSFG95	D-	S-			571€	629€	693€	693€	832€
97↔99	95,4↔97,4			YPLUSFG97	D-	S-			604€	665€	735€	735€	881€
99↔101	97,4↔99,4			YPLUSFG99	D-	S-			604€	665€	735€	735€	881€
101↔103	99,4↔101,4			YPLUSFG101	D-	S-			604€	665€	735€	735€	881€
103↔105	101,4↔103,4			YPLUSFG103	D-	S-			604€	665€	735€	735€	881€
117↔119	115,4↔117,4			YPLUSFG117	D-	S-			638€	689€	745€	745€	894€
119↔121	117,4↔119,4			YPLUSFG119	D-	S-			638€	689€	745€	745€	894€

¡IMPORTANTE!
INDICAR EN PEDIDO SI EL PLATO ES SOBREELEVADO O A RAS DE SUELO
INDICAR EN ENCOMENDA SE A BASE E SOBRE ELEVADO O A NIVEL DO CHÃO

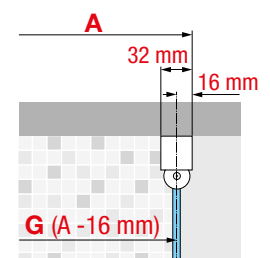



CRISTAL TEMPLADO / VIDRO TEMPERADO



Transparente
cod 1



Banda satinada
cod 44

COLORES PERFILES / CORES PERFÍS



Blanco
Branco
cod. D

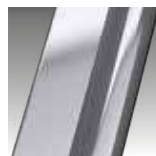

Silver
Abrillantado
cod. B



Cromo
cod. K



Negro mate
cod H



Inox satinado
cod Z

YOUNG PLUS 2G



ANGULAR DE DOS PUERTAS ABATIBLES
ANGULAR DE DUAS FOLHAS ABATÍVEIS

Medidas				Código	Selección Cristales Seleção Vidros		Selección de perfiles Seleção de perfis				
Medidas extensibilidad Medidas extensibilidade	Medidas extensibilidad para platos a ras de suelo	Entrada	Espacio de apertura Espaço de abertura		1	44	U	B	K	H	Z
A	G	*	B		Transparente	banda satinada	Blanco mate Branco mate	Silver Abrilhantado	Cromo	Negro mate	Inox satinado
76↔78	74,4↔76,4	96	68	YPLUS2G76L-							
77↔79	75,4↔77,4	97	69	YPLUS2G77L-							
79↔81	77,4↔79,4	100	71	YPLUS2G79L-							
81↔83	79,4↔81,4	103	73	YPLUS2G81L-							
83↔85	81,4↔83,4	106	75	YPLUS2G83L-							
85↔87	83,4↔85,4	108	77	YPLUS2G85L-							
87↔89	85,4↔87,4	111	79	YPLUS2G87L-							
89↔91	87,4↔89,4	114	81	YPLUS2G89L-							
91↔93	89,4↔91,4	117	83	YPLUS2G91L-							
93↔95	91,4↔93,4	120	85	YPLUS2G93L-							
95↔97	93,4↔95,4	123	87	YPLUS2G95L-							
97↔99	95,4↔97,4	125	89	YPLUS2G97L-							
99↔101	97,4↔99,4	128	91	YPLUS2G99L-							
101↔103	99,4↔101,4	131	93	YPLUS2G101L-							
103↔105	101,4↔103,4	134	95	YPLUS2G103L-							
H 140↔220 L 60↔120		ESPECIAL		YPLUS2GLSP	-		893 €	983 €	983 €	1.179 €	1.112 €

PARA COMPONER UN ÁNGULO PEDIR 2 LATERALES
FORMAR UM ÂNGULO PEDINDO DOIS LATERAIS

OPCIONAL



JUNTA HORIZONTAL INFERIOR
 PARA INSTALACIONES SIN KIT
 ESTANCO

Código	Precio / Preço
R55SPBOA01-TR	46 €

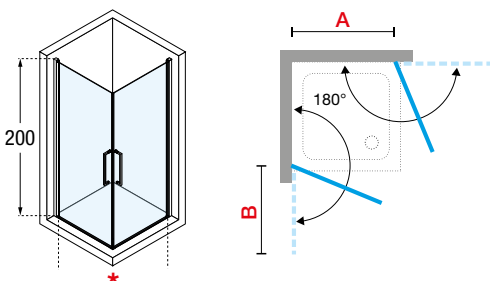

¡IMPORTANTE!
INDICAR EN PEDIDO
SI EL PLATO ES
SOBREELEVADO O A
RAS DE SUELO
INDICAR NA
ENCOMENDA SE
A BASE E SOBRE
ELEVADO O A NIVEL
DO CHÃO

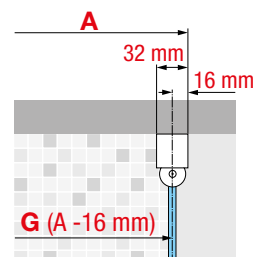



CRISTAL TEMPLADO / VIDRO TEMPERADO



Transparente
cod 1



Banda satinada
cod 44

COLORES PERFILES / CORES PERFÍS



Blanco
Branco
cod. D

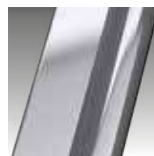

Silver
Abrillantado
cod. B



Cromo
cod. K



Negro mate
cod H



Inox satinado
cod Z

DATOS TÉCNICOS / DADOS TÉCNICOS

COLORES PERFILES / CORES PERFÍS

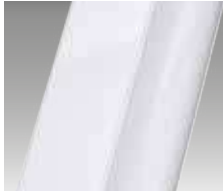

Blanco
Branco
cod. D



Silver
Abrillantado
cod. B



Cromo
cod. K 



Negro mate
cod. H



Inox
cod. Z

CRISTAL TEMPLADO / VIDRO TEMPERADO 8 mm (Según norma Europea UNE EN 14428)



Transparente
cod. 1 



Banda satinada
cod. 44

OPCIONAL



Tirador doble cromado / Puxador cromo

Color Cores	Código	Precio / Preço
Cromo	R40EIMAY21-K	93 €
Negro	R40EIMAY21-H	93 €

MEDIDAS QUE OCUPAN LOS PERFILES EN LA PARED / ESPAÇO QUE OCUPAN OS PERFÍS NA PAREDE

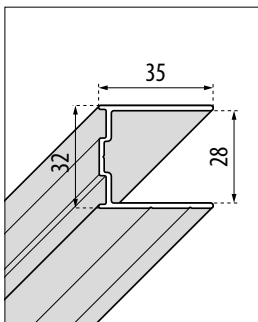

A PARED

Altura	Perfiles/Perfis	Código
1984	Blanco/Branco	P01BNMOBST-U
	Silver/Abrillantado	P01BNMOBST-B
	Cromo	P01BNMOBST-K
	Negro	P01BNMOBST-H
	Inox	P01BNMOBST-Z
2000	Blanco/Branco	P01BNMOAST-U
	Silver/Abrillantado	P01BNMOAST-B
	Cromo	P01BNMOAST-K
	Negro	P01BNMOAST-H
	Inox	P01BNMOAST-Z

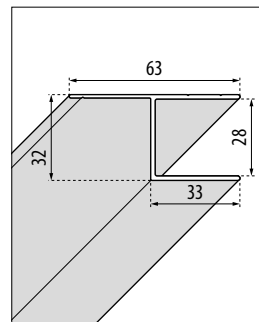

A PARED (OPCIONAL)

Altura	Perfiles/Perfis	Código
1984	Blanco/Branco	P01Y2MOBSTL-U
	Silver/Abrillantado	P01Y2MOBSTL-B
	Cromo	P01Y2MOBSTL-K
	Negro	P01Y2MOBSTL-H
	Inox	P01Y2MOBSTL-Z
2000	Blanco/Branco	P01Y2MOBSTL-U
	Silver/Abrillantado	P01Y2MOBSTL-B
	Cromo	P01Y2MOBSTL-K
	Negro	P01Y2MOBSTL-H
	Inox	P01Y2MOBSTL-Z

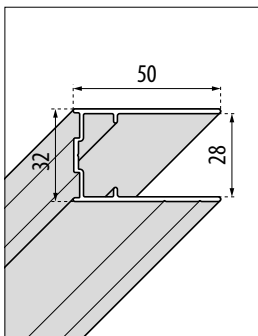

COMPENSADORES

en lugar del perfil de pared (+15mm)
em lugar do perfil parede (+15mm)

Altura	Perfiles/Perfis	Código
1984	Blanco/Branco	P05Y2ST-U
	Silver/Abrillantado	P05Y2ST-B
	Cromo	P05Y2ST-K
	Negro	P05Y2ST-H
	Inox	P05Y2ST-Z
2000	Blanco/Branco	P05Y2ST-U
	Silver/Abrillantado	P05Y2ST-B
	Cromo	P05Y2ST-K
	Negro	P05Y2ST-H
	Inox	P05Y2ST-Z

TOMA DE MEDIDAS

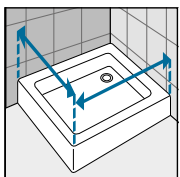

Tomar las medidas desde la pared hasta el borde externo del plato de ducha.

Medir a distância desde a parede até o rebordo externo da base de chuveiro.

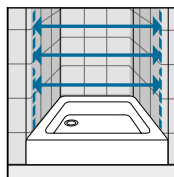

Tomar medidas de pared a pared, medir la parte baja, la central y la superior. Cursar el pedido con la medida más pequeña.

Medir a distância entre paredes, tem que tirar três medidas (inferior, superior e central) e utilizar a inferior. Encomendar pedido da medida mais pequena.



YOUNG

ESENCIAL, VERSÁTIL,
SIMPLE.

ESSENCIAL, VERSÁTIL
E SIMPLES



◀ Tirador metálico cromo
Puxador cromo



◀ Apertura interior - exterior



◀ Bisagras de metal con sistema de auto-elevación.
Dobradiça de metal cromo com sistema de auto elevação



TRATAMIENTOS / TRATAMENTOS





YOUNG

YOUNG G+F EN LÍNEA/EM LINHA



MAMPARA DE UNA PUERTA ABATIBLE + FIJO EN LÍNEA

ARA INSTALAR ENTRE PAREDES O CON FIJO LATERAL YOUNG F1B

RESGUARDO DE UNA PORTA ABATÍVELS + FIXO EM LINHA

PARA INSTALAR ENTRE PARADES OU COM FIXO LATERAL YOUNG F1B

Medidas						Código	Selección Cristales Seleção Vidros			Selección de perfiles Seleção de perfis			
Medidas extensibilidad Medidas extensibilidade con fijo com fixo	Medidas extensibilidad para platos a ras de suelo	Entre paredes	Fijo panel en línea Fixo painel em linha	Entrada	Espacio de apertura Espaço de abertura		1	2	4	U	B	K	H
A	G	A1	F1	*	B	Transparente	Aqua	Satinado Fosco	Blanco mate Branco mate	Silver Abrillantado	Cromo	Negro mate	
FRONTAL COMPUESTO POR PUERTA ABATIBLE + FIJO EN LINEA													
98↔102	96,4↔100,4	97↔101	32,5	58	59	Y2GFL97-				718 €	790 €	869 €	869 €
108↔112	106,4↔110,4	107↔111	42,5	58	59	Y2GFL107-				737 €	810 €	893 €	893 €
115↔119	113,4↔117,4	114↔118	39,5	68	69	Y2GFL114-				753 €	830 €	914 €	914 €
118↔122	116,4↔120,4	117↔121	42,5	68	69	Y2GFL117-				753 €	830 €	914 €	914 €
135↔139	133,4↔137,4	134↔138	49,5	78	79	Y2GFL134-				799 €	880 €	969 €	969 €
138↔142	136,4↔140,4	137↔141	52,5	78	79	Y2GFL137-		+ 40 €	+ 40 €	845 €	930 €	1.023 €	1.023 €
148↔152	146,4↔150,4	147↔151	52,5	88	89	Y2GFL147-				868 €	954 €	1.053 €	1.053 €
155↔159	153,4↔157,4	154↔158	59,5	88	89	Y2GFL154-				880 €	969 €	1.067 €	1.067 €
158↔162	156,4↔160,4	157↔161	62,5	88	89	Y2GFL157-				894 €	984 €	1.081 €	1.081 €
165↔169	163,4↔167,4	164↔168	69,5	88	89	Y2GFL164-				900 €	990 €	1.089 €	1.089 €
168↔172	166,4↔170,4	167↔171	72,5	88	89	Y2GFL167-				905 €	995 €	1.097 €	1.097 €
178↔182	176,4↔180,4	177↔181	82,5	88	89	Y2GFL177-				917 €	1.009 €	1.111 €	1.111 €
H 140↔220 L 97↔177						ESPECIAL Y2GFLSP	+ 40 €	+ 40 €		1.271 €	1.398 €	1.539 €	1.539 €

PANEL FIJO LATERAL OPCIONAL													
F													
57↔59	55,4↔57,4	-	-	-	-	Y2F1B57-				398 €	439 €	482 €	482 €
59↔61	57,4↔59,4	-	-	-	-	Y2F1B59-				398 €	439 €	482 €	482 €
65↔67	63,4↔65,4	-	-	-	-	Y2F1B65-				424 €	466 €	513 €	513 €
67↔69	65,4↔67,4	-	-	-	-	Y2F1B67-				424 €	466 €	513 €	513 €
69↔71	67,4↔69,4	-	-	-	-	Y2F1B69-				424 €	466 €	513 €	513 €
73↔75	71,4↔73,4	-	-	-	-	Y2F1B73-				451 €	496 €	545 €	545 €
75↔77	73,4↔75,4	-	-	-	-	Y2F1B75-				451 €	496 €	545 €	545 €
76↔78	74,4↔76,4	-	-	-	-	Y2F1B76-				451 €	496 €	545 €	545 €
77↔79	75,4↔77,4	-	-	-	-	Y2F1B77-				451 €	496 €	545 €	545 €
79↔81	77,4↔79,4	-	-	-	-	Y2F1B79-				451 €	496 €	545 €	545 €
81↔83	79,4↔81,4	-	-	-	-	Y2F1B81-		+ 40 €	+ 40 €	451 €	496 €	545 €	545 €
85↔87	83,4↔85,4	-	-	-	-	Y2F1B85-				476 €	524 €	577 €	577 €
87↔89	85,4↔87,4	-	-	-	-	Y2F1B87-				476 €	524 €	577 €	577 €
89↔91	87,4↔89,4	-	-	-	-	Y2F1B89-				476 €	524 €	577 €	577 €
91↔93	89,4↔91,4	-	-	-	-	Y2F1B91-				476 €	524 €	577 €	577 €
95↔97	93,4↔95,4	-	-	-	-	Y2F1B95-				476 €	524 €	577 €	577 €
97↔99	95,4↔97,4	-	-	-	-	Y2F1B97-				504 €	554 €	612 €	612 €
99↔101	97,4↔99,4	-	-	-	-	Y2F1B99-				504 €	554 €	612 €	612 €
101↔103	99,4↔101,4	-	-	-	-	Y2F1B101-				504 €	554 €	612 €	612 €
117↔119	115,4↔117,4	-	-	-	-	Y2F1B117-				504 €	554 €	612 €	612 €
119↔121	117,4↔119,4	-	-	-	-	Y2F1B119-				504 €	554 €	612 €	612 €
H 140↔220 L 20↔120						ESPECIAL Y2F1BSP	+ 40 €	+ 40 €		624 €	688 €	757 €	757 €

EL FIJO ESPECIAL SE DEBE PEDIR CON LA MISMA ALTURA DE LA PUERTA. / O FIXO ESPECIAL DEVE-SE PEDIR COM A MESMA ALTURA DA PORTA

BARRA DE SUJECIÓN A PARED DE 150 CM. INCLUIDA

CONSULTA OTRAS COMBINACIONES ENTRE PUERTAS Y FIJOS

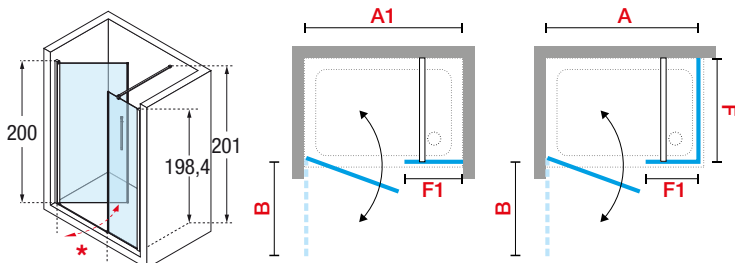

¡IMPORTANTE!
INDICAR EN PEDIDO SI EL PLATO ES SOBREELEVADO O A RAS DE SUELO
INDICAR NA ENCOMENDA SE A BASE E SOBRE ELEVADO O A NIVEL DO CHÃO

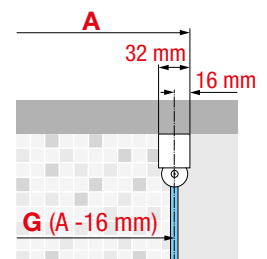



OPCIONAL

	JUNTA HORIZONTAL INFERIOR PARA INSTALACIONES SIN KIT ESTANCO	
	Código	Precio / Preço
	R55SPBOM01-TR	46 €

CRISTAL TEMPLADO / VIDRO TEMPERADO



Transparente
cod 1



Aqua
cod 2

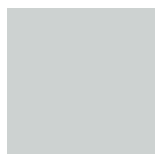

Satinado
Fosco
cod 4

COLORES PERFILES / CORES PERFÍS



Blanco mate
Branco mate
cod. U

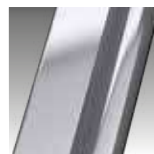

Silver
Abrillantado
cod. B



Cromo
cod K



Negro mate
cod H

YOUNG 2P+FL



200 cm



6 mm



4 cm
puerta
porta



2 cm
fijo
fijo



PUERTA DE UNA HOJA ABATIBLE Y FIJO + UN FIJO LATERAL

PARA INSTALAR ENTRE PAREDES O CON FIJO LATERAL YOUNG F1B

RESGUARDO PARA DUCHE COMPOSTO POR UMA PORTA ABATIBEL + 1 FIJO E PAIENL FIXO LATERAL

PARA INSTALAR ENTRE PARADES OU COM FIXO LATERAL YOUNG F1B

Medidas							Código	Selección Cristales Selecção Vidros			Selección de perfiles Selecção de perfis			
Medidas extensibilidad Medidas extensibilidade			Fijo panel en línea Fixo painel em linha	Entrada	Espacio de apertura Espaço de abertura			1	2	4	U	B	K	H
con fijo com fijo	para platos a ras de suelo	Entre paredes						Transparente	Aqua	Satinado Fosco	Blanco mate Branco mate	Silver Abrillantado	Cromo	Negro mate
A	G	A1	F1	F2	*	B								
FRONTAL COMPUESTO POR PUERTA + FIJO + FIJO EN LINEA														
138↔142	136,4↔140,4	137↔141	20↔22	54	60	61	Y22PFL137-				1.063 €	1.170 €	1.287 €	1.287 €
148↔152	156,4↔150,4	147↔151	20↔22	54	70	71	Y22PFL147-				1.091 €	1.201 €	1.322 €	1.322 €
158↔162	156,4↔160,4	157↔161	20↔22	64	70	71	Y22PFL157-				1.117 €	1.227 €	1.350 €	1.350 €
168↔172	166,4↔170,4	167↔171	20↔22	74	70	71	Y22PFL167-	+ 80 €	+ 80 €		1.145 €	1.258 €	1.383 €	1.383 €
178↔182	176,4↔180,4	177↔181	20↔22	84	70	71	Y22PFL177-				1.169 €	1.286 €	1.415 €	1.415 €
188↔192	186,4↔190,4	187↔191	40↔42	64	80	81	Y22PFL187-				1.203 €	1.325 €	1.458 €	1.458 €
198↔202	196,4↔200,4	197↔201	40↔42	74	80	81	Y22PFL197-				1.232 €	1.355 €	1.489 €	1.489 €
PANEL FIJO LATERAL OPCIONAL														
F														
57↔59	55,4↔57,4	-	-	-	-	-	Y2F1B57-				398 €	439 €	482 €	482 €
59↔61	57,4↔59,4	-	-	-	-	-	Y2F1B59-				398 €	439 €	482 €	482 €
65↔67	63,4↔65,4	-	-	-	-	-	Y2F1B65-				424 €	466 €	513 €	513 €
67↔69	65,4↔67,4	-	-	-	-	-	Y2F1B67-				424 €	466 €	513 €	513 €
69↔71	67,4↔69,4	-	-	-	-	-	Y2F1B69-				424 €	466 €	513 €	513 €
73↔75	71,4↔73,4	-	-	-	-	-	Y2F1B73-				451 €	496 €	545 €	545 €
75↔77	73,4↔75,4	-	-	-	-	-	Y2F1B75-				451 €	496 €	545 €	545 €
76↔78	74,4↔76,4	-	-	-	-	-	Y2F1B76-				451 €	496 €	545 €	545 €
77↔79	75,4↔77,4	-	-	-	-	-	Y2F1B77-				451 €	496 €	545 €	545 €
79↔81	77,4↔79,4	-	-	-	-	-	Y2F1B79-				451 €	496 €	545 €	545 €
81↔83	79,4↔81,4	-	-	-	-	-	Y2F1B81-	+ 40 €	+ 40 €		451 €	496 €	545 €	545 €
85↔87	83,4↔85,4	-	-	-	-	-	Y2F1B85-				476 €	524 €	577 €	577 €
87↔89	85,4↔87,4	-	-	-	-	-	Y2F1B87-				476 €	524 €	577 €	577 €
89↔91	87,4↔89,4	-	-	-	-	-	Y2F1B89-				476 €	524 €	577 €	577 €
91↔93	89,4↔91,4	-	-	-	-	-	Y2F1B91-				476 €	524 €	577 €	577 €
95↔97	93,4↔95,4	-	-	-	-	-	Y2F1B95-				476 €	524 €	577 €	577 €
97↔99	95,4↔97,4	-	-	-	-	-	Y2F1B97-				504 €	554 €	612 €	612 €
99↔101	97,4↔99,4	-	-	-	-	-	Y2F1B99-				504 €	554 €	612 €	612 €
101↔103	99,4↔101,4	-	-	-	-	-	Y2F1B101-				504 €	554 €	612 €	612 €
117↔119	115,4↔117,4	-	-	-	-	-	Y2F1B117-				504 €	554 €	612 €	612 €
119↔121	117,4↔119,4	-	-	-	-	-	Y2F1B119-				504 €	554 €	612 €	612 €
H 140↔220							Y2F1BSP	+ 40 €	+ 40 €		624 €	688 €	757 €	757 €
L 20↔120						ESPECIAL								

OPCIONAL



JUNTA HORIZONTAL INFERIOR
PARA INSTALACIONES SIN KIT
ESTANCO

Código	Precio / Preço
R55SPBOM01-TR	46 €

IMPORTANTE!
INDICAR EN PEDIDO
SI EL PLATO ES
SOBREELEVADO O A
RAS DE SUELO

INDICAR NA
ENCOMENDA SE
A BASE E SOBRE
ELEVADO O A NIVEL
DO CHÃO

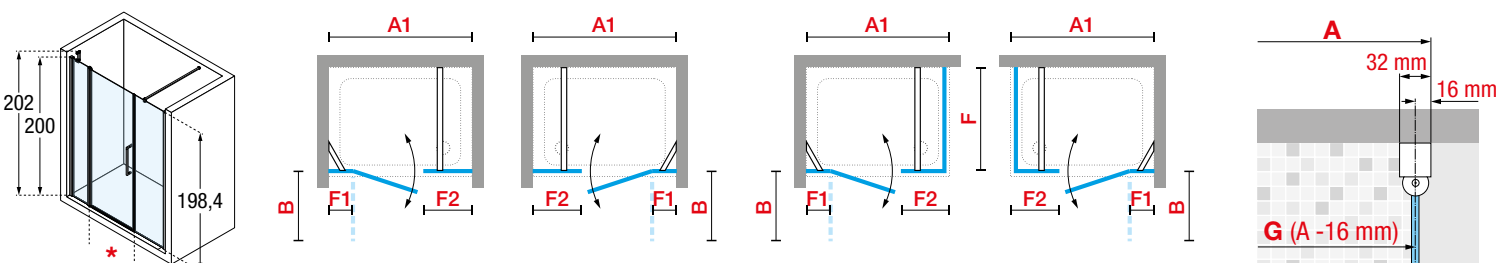

174 Construcción del código: **Código** + **Cristales Vidros** + **Perfiles Perfis** = Código completo del producto
 Construção do código **Código** + **Cristales Vidros** + **Perfiles Perfis** = Código completo do produto



CRISTAL TEMPLADO / VIDRO TEMPERADO



Transparente
cod 1



Aqua
cod 2

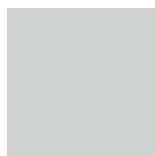

Satinado
Fosco
cod 4

COLORES PERFILES / CORES PERFÍS



Blanco mate
Branco mate
cod. U

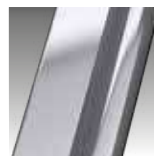

Silver
Abrillantado
cod. B



Cromo
cod K



Negro mate
cod H

YOUNG 2P+F



200 cm



6 mm



4 cm
puerta
porta



2 cm
fijo
fijo



PUERTA DE UNA HOJA ABATIBLE Y FIJO

PARA INSTALAR ENTRE PAREDES O CON FIJO LATERAL YOUNG F1B

RESGUARDO PARA DUCHE COMPOSTO POR UMA PORTA ABATIVEL + 1 FIXO

PARA INSTALAR ENTRE PAREDES OU COM FIJO LATERAL YOUNG F1B

Medidas						Código	Selección Cristales Seleção Vidros			Selección de perfiles Seleção de perfis				
Medidas extensibilidad Medidas extensibilidade			Fijo panel en línea Fixo painel em linha	Entrada	Espacio de apertura Espaço de abertura		1	2	4	U	B	K	H	
con fijo com fijo	para platos a ras de suelo	Entre paredes												
A	G	A1	F1	*	B		Transparente	Aqua	Satinado Fosco	Blanco mate Branco mate	Silver Abrillantado	Cromo	Negro mate	
PUERTA + FIJO EN LINEA														
78↔82	76,4↔80,4	77↔81	20↔22	51	51	Y22P77-				666 €	734 €	805 €	805 €	
88↔92	86,4↔90,4	87↔91	20↔22	61	61	Y22P87-				694 €	762 €	840 €	840 €	
98↔102	96,4↔100,4	97↔101	20↔22	71	71	Y22P97-				721 €	794 €	875 €	875 €	
108↔112	106,4↔110,4	107↔111	20↔22	81	81	Y22P107-	+ 40 €	+ 40 €		750 €	826 €	908 €	908 €	
118↔122	116,4↔120,4	117↔121	40↔42	71	71	Y22P117-				781 €	859 €	946 €	946 €	
138↔142	136,4↔140,4	137↔141	40↔42	91	91	Y22P137-				806 €	887 €	977 €	977 €	
H 140↔220						ESPECIAL Y22PSP	+ 40 €	+ 40 €		1.009 €	1.110 €	1.221 €	1.221 €	
L 78↔200														

PANEL FIJO LATERAL OPCIONAL														
F														
A	G	A1	F1	*	B		1	2	4	U	B	K	H	
57↔59	55,4↔57,4	-	-	-	-	Y2F1B57-				398 €	439 €	482 €	482 €	
59↔61	57,4↔59,4	-	-	-	-	Y2F1B59-				398 €	439 €	482 €	482 €	
65↔67	63,4↔65,4	-	-	-	-	Y2F1B65-				424 €	466 €	513 €	513 €	
67↔69	65,4↔67,4	-	-	-	-	Y2F1B67-				424 €	466 €	513 €	513 €	
69↔71	67,4↔69,4	-	-	-	-	Y2F1B69-				424 €	466 €	513 €	513 €	
73↔75	71,4↔73,4	-	-	-	-	Y2F1B73-				451 €	496 €	545 €	545 €	
75↔77	73,4↔75,4	-	-	-	-	Y2F1B75-				451 €	496 €	545 €	545 €	
76↔78	74,4↔76,4	-	-	-	-	Y2F1B76-				451 €	496 €	545 €	545 €	
77↔79	75,4↔77,4	-	-	-	-	Y2F1B77-				451 €	496 €	545 €	545 €	
79↔81	77,4↔79,4	-	-	-	-	Y2F1B79-				451 €	496 €	545 €	545 €	
81↔83	79,4↔81,4	-	-	-	-	Y2F1B81-	+ 40 €	+ 40 €		451 €	496 €	545 €	545 €	
85↔87	83,4↔85,4	-	-	-	-	Y2F1B85-				476 €	524 €	577 €	577 €	
87↔89	85,4↔87,4	-	-	-	-	Y2F1B87-				476 €	524 €	577 €	577 €	
89↔91	87,4↔89,4	-	-	-	-	Y2F1B89-				476 €	524 €	577 €	577 €	
91↔93	89,4↔91,4	-	-	-	-	Y2F1B91-				476 €	524 €	577 €	577 €	
95↔97	93,4↔95,4	-	-	-	-	Y2F1B95-				476 €	524 €	577 €	577 €	
97↔99	95,4↔97,4	-	-	-	-	Y2F1B97-				504 €	554 €	612 €	612 €	
99↔101	97,4↔99,4	-	-	-	-	Y2F1B99-				504 €	554 €	612 €	612 €	
101↔103	99,4↔101,4	-	-	-	-	Y2F1B101-				504 €	554 €	612 €	612 €	
117↔119	115,4↔117,4	-	-	-	-	Y2F1B117-				504 €	554 €	612 €	612 €	
119↔121	117,4↔119,4	-	-	-	-	Y2F1B119-				504 €	554 €	612 €	612 €	
H 140↔220						ESPECIAL Y2F1BSP	+ 40 €	+ 40 €		624 €	688 €	757 €	757 €	
L 20↔120														

**PARA ESTA SOLUCIÓN NO ES POSIBLE UTILIZAR EL KIT EN "T". UTILIZAR LAS BARRAS DE SUJECIÓN SUMINISTRADAS (VER IMAGEN A LA DERECHA).
PARA ESTA SOLUÇÃO SÓ SE PODE UTILIZAR A BARRA DE FIXAÇÃO INCLUÍDA (VER IMAGEM À DIREITA).**

OPCIONAL



KIT BARRA EN "T"
Para instalar con dos fijos en angulo
instalar com dois ângulos fijos

Color Cores	Código	Precio Preço
Blanco / Branco	R80Y22P15T-U	71 €
Silver / Abrillantado	R80Y22P15T-B	76 €
Cromo	R80Y22P15T-K	83 €
Negro mate	R80Y22P15T-H	83 €



JUNTA HORIZONTAL INFERIOR
PARA INSTALACIONES SIN KIT ESTANCO

Código	Precio / Preço
R55SPBOM01-TR	46 €

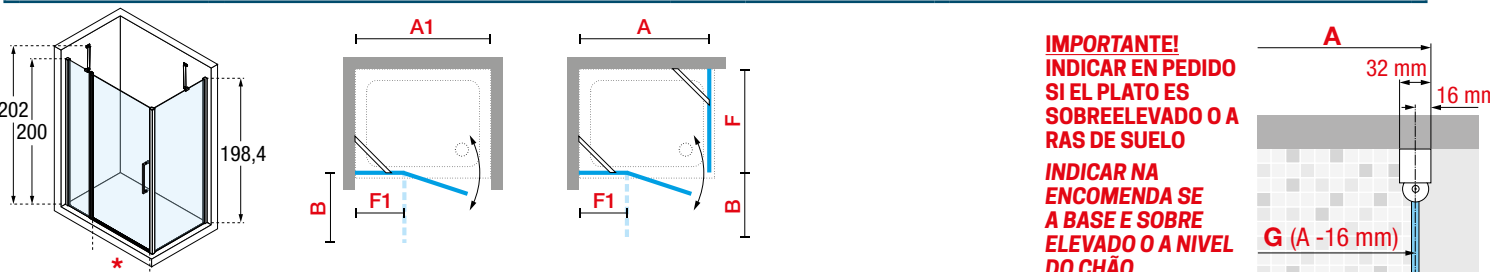

¡IMPORTANTE!
INDICAR EN PEDIDO SI EL PLATO ES SOBREELEVADO O A RAS DE SUELO
INDICAR NA ENCOMENDA SE A BASE E SOBRE ELEVADO O A NIVEL DO CHÃO



CRISTAL TEMPLADO / VIDRO TEMPERADO



Transparente
cod 1



Aqua
cod 2



Satinado
Fosco
cod 4

COLORES PERFILES / CORES PERFÍS



Blanco mate
Branco mate
cod. U

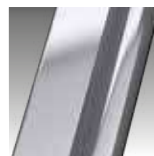

Silver
Abrillantado
cod. B



Cromo
cod K



Negro mate
cod H

YOUNG 2A



FRONTAL DE DOS PUERTAS ABATIBLES + DOS FIJOS

RESGUARDO PARA DUCHE COMPOSTA POR DUAS PORTAS CENTRAIS E DOS FIXOS

Medidas				Código	Selección Cristales Seleção Vidros			Selección de perfiles Seleção de perfis					
Medidas extensibilidad Medidas extensibilidade	fijo panel en línea Fixo painel em linha	Entrada	Espacio de apertura Espaço de abertura		1	2	4	U	B	K	H		
A	F1	*	B		Transparente	Aqua	Satinado Fosco	Blanco mate Branco mate	Silver Abrillantado	Cromo	Negro mate		
97↔101	25	43	22	Y22A97-				936 €	1.030 €	1.133 €	1.133 €		
117↔121	30	53	27	Y22A117-				936 €	1.030 €	1.133 €	1.133 €		
137↔141	36	61	31	Y22A137-				979 €	1.078 €	1.187 €	1.187 €		
147↔151	37	69	35	Y22A147-				+ 80 €	+ 80 €	979 €	1.078 €	1.187 €	1.187 €
157↔161	40	73	37	Y22A157-				1.034 €	1.140 €	1.254 €	1.254 €		
167↔171	43	77	39	Y22A167-				1.034 €	1.140 €	1.254 €	1.254 €		
177↔181	45	81	41	Y22A177-				1.078 €	1.187 €	1.306 €	1.306 €		

2 BARRAS ESTABILIZADORAS INCLUIDAS DE SERIE

OPCIONAL



JUNTA HORIZONTAL INFERIOR
PARA INSTALACIONES SIN KIT
ESTANCO

Código	Precio / Preço
R55SPB02A1-TR	27 €

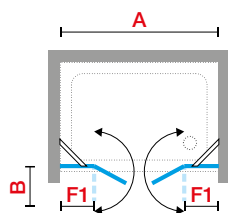
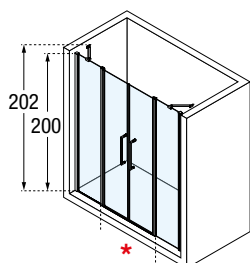

IMPORTANTE!
INDICAR EN PEDIDO
SI EL PLATO ES
SOBREELEVADO O A
RAS DE SUELO

**INDICAR NA
ENCOMENDA SE
A BASE E SOBRE
ELEVADO O A NIVEL
DO CHÃO**

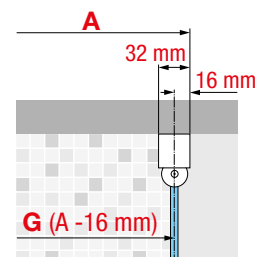



CRISTAL TEMPLADO / VIDRO TEMPERADO



Transparente
cod 1



Aqua
cod 2

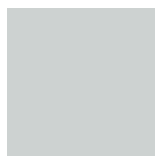

Satinado
Fosco
cod 4

COLORES PERFILES / CORES PERFÍS



Blanco mate
Branco mate
cod. U

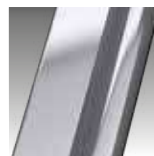

Silver
Abrillantado
cod. B



Cromo
cod K



Negro mate
cod H

YOUNG 2B



200 cm



6 mm



4 cm
puerta
porta



2 cm
fijo
fijo



MAMPARA DE DOS HOJAS ABATIBLES

PARA INSTALAR ENTRE PAREDES O CON FIJO LATERAL YOUNG F2B

RESGUARDO DE DUAS FOLHAS ABATÍVEIS

PARA INSTALAR ENTRE PAREDES OU COM FIJO LATERAL YOUNG F2B

Medidas						Código	Selección Cristales Seleção Vidros			Selección de perfiles Seleção de perfis			
Medidas extensibilidad Medidas extensibilidade con fijo com fijo	Medidas extensibilidad para platos a ras de suelo	Entre paredes	Panel fijo lateral Painel fixo lateral	Entrada	Espacio de apertura Espaço de abertura		1	2	4	U	B	K	H
A	G	A1	F	*	B		Transparente	Aqua	Satinado Fosco	Blanco mate Branco mate	Silver Abrillantado	Cromo	Negro mate
PUERTA / PORTA													
58↔62	56,4↔60,4	57↔61		45	23	Y22B57-				718 €	790 €	869 €	869 €
64↔68	62,4↔66,4	63↔67		51	26	Y22B63-				718 €	790 €	869 €	869 €
68↔72	66,4↔70,4	67↔71		55	28	Y22B67-				718 €	790 €	869 €	869 €
72↔76	70,4↔74,4	71↔75		59	30	Y22B71-				755 €	831 €	915 €	915 €
74↔78	72,4↔76,4	73↔77		61	31	Y22B73-				755 €	831 €	915 €	915 €
78↔82	76,4↔80,4	77↔81		65	33	Y22B77-				755 €	831 €	915 €	915 €
84↔88	82,4↔86,4	83↔87		71	36	Y22B83-				792 €	871 €	958 €	958 €
88↔92	86,4↔90,4	87↔91		75	38	Y22B87-				792 €	871 €	958 €	958 €
94↔98	92,4↔96,4	93↔97		81	41	Y22B93-				792 €	871 €	958 €	958 €
98↔102	96,4↔100,4	97↔101		85	43	Y22B97-		+ 40 €	+ 40 €	829 €	912 €	1.004 €	1.004 €
104↔108	102,4↔106,4	103↔107		91	46	Y22B103-				829 €	912 €	1.004 €	1.004 €
108↔112	106,4↔110,4	107↔111		95	48	Y22B107-				829 €	912 €	1.004 €	1.004 €
114↔118	112,4↔116,4	113↔117		101	51	Y22B113-				863 €	949 €	1.044 €	1.044 €
118↔122	116,4↔120,4	117↔121		105	53	Y22B117-				863 €	949 €	1.044 €	1.044 €
138↔142	136,4↔140,4	137↔141		125	63	Y22B137-				905 €	995 €	1.097 €	1.097 €
148↔152	146,4↔150,4	147↔151		135	68	Y22B147-				942 €	1.037 €	1.143 €	1.143 €
158↔162	156,4↔160,4	157↔161		145	73	Y22B157-				942 €	1.037 €	1.143 €	1.143 €
168↔172	166,4↔170,4	167↔171		155	78	Y22B167-				979 €	1.078 €	1.187 €	1.187 €
178↔182	176,4↔180,4	177↔181		165	83	Y22B177-				979 €	1.078 €	1.187 €	1.187 €
H 140†220						ESPECIAL Y22BSP		+ 40 €	+ 40 €	1.063 €	1.169 €	1.287 €	1.287 €
L 57↔177													

FIJO PANEL / FIJO PAINEL													
-	55,4↔57,4	-	57↔59	-	-	Y2F2B57-				398 €	439 €	482 €	482 €
-	57,4↔59,4	-	59↔61	-	-	Y2F2B59-				398 €	439 €	482 €	482 €
-	63,4↔65,4	-	65↔67	-	-	Y2F2B65-				424 €	466 €	513 €	513 €
-	65,4↔67,4	-	67↔69	-	-	Y2F2B67-				424 €	466 €	513 €	513 €
-	67,4↔69,4	-	69↔71	-	-	Y2F2B69-				424 €	466 €	513 €	513 €
-	71,4↔73,4	-	73↔75	-	-	Y2F2B73-				451 €	496 €	545 €	545 €
-	73,4↔75,4	-	75↔77	-	-	Y2F2B75-				451 €	496 €	545 €	545 €
-	74,4↔76,4	-	76↔78	-	-	Y2F2B76-				451 €	496 €	545 €	545 €
-	75,4↔77,4	-	77↔79	-	-	Y2F2B77-				451 €	496 €	545 €	545 €
-	77,4↔79,4	-	79↔81	-	-	Y2F2B79-				451 €	496 €	545 €	545 €
-	79,4↔81,4	-	81↔83	-	-	Y2F2B81-		+ 40 €	+ 40 €	451 €	496 €	545 €	545 €
-	83,4↔85,4	-	85↔87	-	-	Y2F2B85-				476 €	524 €	577 €	577 €
-	85,4↔87,4	-	87↔89	-	-	Y2F2B87-				476 €	524 €	577 €	577 €
-	87,4↔89,4	-	89↔91	-	-	Y2F2B89-				476 €	524 €	577 €	577 €
-	89,4↔91,4	-	91↔93	-	-	Y2F2B91-				476 €	524 €	577 €	577 €
-	93,4↔95,4	-	95↔97	-	-	Y2F2B95-				476 €	524 €	577 €	577 €
-	95,4↔97,4	-	97↔99	-	-	Y2F2B97-				504 €	554 €	612 €	612 €
-	97,4↔99,4	-	99↔101	-	-	Y2F2B99-				504 €	554 €	612 €	612 €
-	99,4↔101,4	-	101↔103	-	-	Y2F2B101-				504 €	554 €	612 €	612 €
-	115,4↔117,4	-	117↔119	-	-	Y2F2B117-				504 €	554 €	612 €	612 €
-	117,4↔119,4	-	119↔121	-	-	Y2F2B119-				504 €	554 €	612 €	612 €
-		-	H 140†220	-		ESPECIAL Y2F2BSP		+ 40 €	+ 40 €	624 €	688 €	757 €	757 €
			L 20↔120	-									

BARRA DE SUJECIÓN A PARED DE 150 CM. INCLUIDA BARRA DE FIXAÇÃO À PAREDE DE 150 CM. INCLUIDA

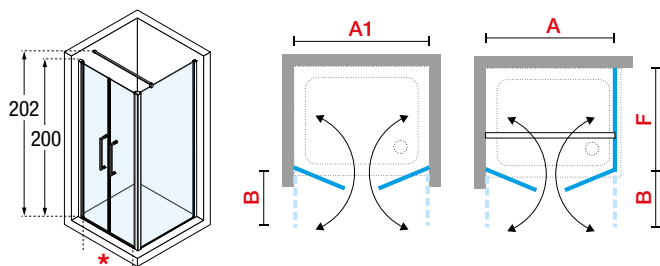

IMPORTANTE!
INDICAR EN PEDIDO
SI EL PLATO ES
SOBREELEVADO O A
RAS DE SUELO

INDICAR NA
ENCOMENDA SE
A BASE E SOBRE
ELEVADO O A NIVEL
DO CHÃO

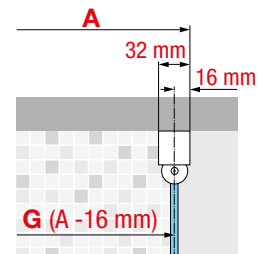



OPCIONAL



**JUNTA HORIZONTAL INFERIOR
100 cm**

Para instalaciones sin kit estanque
(para medidas superior a 114 cm
pedir 2 unid.)

Para instalações sem kit estanque
para medições superiores a 114 cm,
encomendar 2 peças.

Código	Precio / Preço
R55SPB02A1-TR	27 €

CRISTAL TEMPLADO / VIDRO TEMPERADO



Transparente
cod 1



Aqua
cod 2

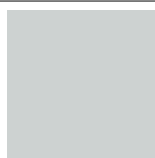

Satinado
Fosco
cod 4

COLORES PERFILES / CORES PERFÍS



Blanco mate
Branco mate
cod. U

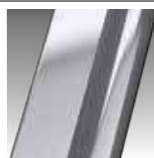

Silver
Abrillantado
cod. B



Cromo
cod K



Negro mate
cod H

YOUNG 1B

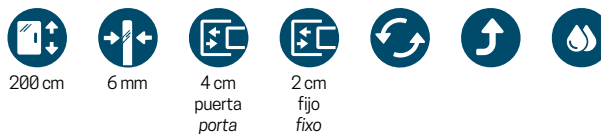

MAMPARA DE UNA PUERTA ABATIBLE

PARA INSTALAR ENTRE PAREDES O CON FIJO LATERAL YOUNG F1B

RESGUARDO DE UMA FOLHA ABATÍVEL

PARA INSTALAR ENTRE PAREDES OU COM FIXO LATERAL YOUNG F1B

Medidas						Código	Selección Cristales Seleção Vidros			Selección de perfiles Seleção de perfis			
Medidas extensibilidad Medidas extensibilidade con fijo com fijo	Medidas extensibilidad para platos a ras de suelo	Entre paredes	Panel fijo lateral Painel fixo lateral	Entrada	Espacio de apertura Espaço de abertura		1	2	4	U	B	K	H
A	G	A1	F	*	B	Transparente	Aqua	Satinado Fosco	Blanco mate Branco mate	Silver Abrillantado	Cromo	Negro mate	
PUERTA / PORTA													
58↔62	56,4↔60,4	57↔61		47	48	Y21B57-				555 €	613 €	673 €	673 €
68↔72	66,4↔70,4	67↔71		57	58	Y21B67-				578 €	635 €	700 €	700 €
73↔77	71,4↔75,4	72↔76		62	63	Y21B72-				578 €	635 €	700 €	700 €
78↔82	76,4↔80,4	77↔81		67	68	Y21B77-				602 €	663 €	730 €	730 €
80↔84	78,4↔82,4	79↔83		69	70	Y21B79-		+ 40 €	+ 40 €	614 €	675 €	744 €	744 €
83↔87	81,4↔85,4	82↔86		72	73	Y21B82-				614 €	675 €	744 €	744 €
88↔92	86,4↔90,4	87↔91		77	78	Y21B87-				624 €	689 €	757 €	757 €
93↔97	91,4↔95,4	92↔96		82	83	Y21B92-				636 €	702 €	772 €	772 €
98↔102	96,4↔100,4	97↔101		87	88	Y21B97-				650 €	713 €	787 €	787 €
H 140↔220 L 54↔120					ESPECIAL	Y21BSP		+ 40 €	+ 40 €	825 €	906 €	999 €	999 €
PANEL FIJO LATERAL OPCIONAL													
-	55,4↔57,4	-	57↔59	-	-	Y2F1B57-				398 €	439 €	482 €	482 €
-	57,4↔59,4	-	59↔61	-	-	Y2F1B59-				398 €	439 €	482 €	482 €
-	63,4↔65,4	-	65↔67	-	-	Y2F1B65-				424 €	466 €	513 €	513 €
-	65,4↔67,4	-	67↔69	-	-	Y2F1B67-				424 €	466 €	513 €	513 €
-	67,4↔69,4	-	69↔71	-	-	Y2F1B69-				424 €	466 €	513 €	513 €
-	71,4↔73,4	-	73↔75	-	-	Y2F1B73-				451 €	496 €	545 €	545 €
-	73,4↔75,4	-	75↔77	-	-	Y2F1B75-				451 €	496 €	545 €	545 €
-	74,4↔76,4	-	76↔78	-	-	Y2F1B76-				451 €	496 €	545 €	545 €
-	75,4↔77,4	-	77↔79	-	-	Y2F1B77-				451 €	496 €	545 €	545 €
-	77,4↔79,4	-	79↔81	-	-	Y2F1B79-				451 €	496 €	545 €	545 €
-	79,4↔81,4	-	81↔83	-	-	Y2F1B81-		+ 40 €	+ 40 €	451 €	496 €	545 €	545 €
-	83,4↔85,4	-	85↔87	-	-	Y2F1B85-				476 €	524 €	577 €	577 €
-	85,4↔87,4	-	87↔89	-	-	Y2F1B87-				476 €	524 €	577 €	577 €
-	87,4↔89,4	-	89↔91	-	-	Y2F1B89-				476 €	524 €	577 €	577 €
-	89,4↔91,4	-	91↔93	-	-	Y2F1B91-				476 €	524 €	577 €	577 €
-	93,4↔95,4	-	95↔97	-	-	Y2F1B95-				476 €	524 €	577 €	577 €
-	95,4↔97,4	-	97↔99	-	-	Y2F1B97-				504 €	554 €	612 €	612 €
-	97,4↔99,4	-	99↔101	-	-	Y2F1B99-				504 €	554 €	612 €	612 €
-	99,4↔101,4	-	101↔103	-	-	Y2F1B101-				504 €	554 €	612 €	612 €
-	115,4↔117,4	-	117↔119	-	-	Y2F1B117-				504 €	554 €	612 €	612 €
-	117,4↔119,4	-	119↔121	-	-	Y2F1B119-				504 €	554 €	612 €	612 €
-		-	H 140↔220 L 20↔120		ESPECIAL	Y2F1BSP		+ 40 €	+ 40 €	624 €	688 €	757 €	757 €

EL FIJO ESPECIAL SE DEBE PEDIR CON LA MISMA ALTURA DE LA PUERTA. / O FIXO ESPECIAL DEVE-SE PEDIR COM A MESMA ALTURA DA PORTA

BARRA DE SUJECIÓN A PARED DE 150 CM. INCLUIDA

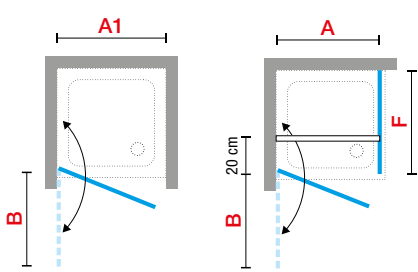
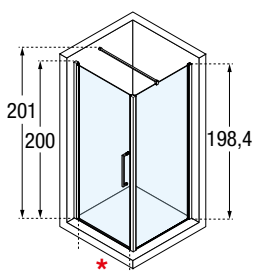

**¡IMPORTANTE!
INDICAR EN PEDIDO
SI EL PLATO ES
SOBREELEVADO O A
RAS DE SUELO
INDICAR NA
ENCOMENDA SE
A BASE E SOBRE
ELEVADO O A NIVEL
DO CHÃO**

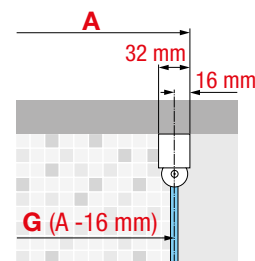



OPCIONAL



JUNTA HORIZONTAL INFERIOR
PARA INSTALACIONES SIN KIT
ESTANCO

Código	Precio / Preço
R55SPBOM01-TR	46 €

CRISTAL TEMPLADO / VIDRO TEMPERADO



Transparente
cod 1



Aqua
cod 2



Satinado
Fosco
cod 4

COLORES PERFILES / CORES PERFÍS



Blanco mate
Branco mate
cod. U

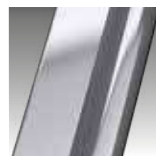

Silver
Abrillantado
cod. B



Cromo
cod K



Negro mate
cod H

PUERTA DE UNA HOJA ABATIBLE + FIJO PORTA DE UNA FOLHA ABATÍVEL + FIXO

Medidas					Código	Selección Cristales Seleção Vidros			Selección de perfiles Seleção de perfis			
Medidas extensibilidad Medidas extensibilidade	Medidas extensibilidad para platos a ras de suelo	Panel fijo lateral Painel fixo lateral	Entrada	Espacio de apertura Espaço de abertura		1	2	4	U	B	K	H
A	G	F1	*	B		Transparente	Aqua	Satinado Fosco	Blanco mate Branco mate	Silver Abrillantado	Cromo	Negro mate
PUERTA / PORTA												
57↔59	55,4↔57,4		48	49	Y2G57-				448 €	493 €	543 €	543 €
59↔61	57,4↔59,4		50	51	Y2G59-				448 €	493 €	543 €	543 €
61↔63	59,4↔61,4		52	53	Y2G61-				448 €	493 €	543 €	543 €
65↔67	63,4↔65,4		56	57	Y2G65-				448 €	493 €	543 €	543 €
67↔69	65,4↔67,4		58	59	Y2G67-				471 €	518 €	571 €	571 €
69↔71	67,4↔69,4		60	61	Y2G69-				471 €	518 €	571 €	571 €
72↔74	70,4↔72,4		63	64	Y2G72-				471 €	518 €	571 €	571 €
74↔76	72,4↔74,4		65	66	Y2G74-				471 €	518 €	571 €	571 €
76↔78	74,4↔76,4		67	68	Y2G76-				471 €	518 €	571 €	571 €
77↔79	75,4↔77,4		68	69	Y2G77-				495 €	544 €	599 €	599 €
79↔81	77,4↔79,4		70	71	Y2G79-	+ 40 €	+ 40 €		495 €	544 €	599 €	599 €
81↔83	79,4↔81,4		72	73	Y2G81-				495 €	544 €	599 €	599 €
85↔87	83,4↔85,4		76	77	Y2G85-				495 €	544 €	599 €	599 €
87↔89	85,4↔87,4		78	79	Y2G87-				517 €	570 €	628 €	628 €
89↔91	87,4↔89,4		80	81	Y2G89-				517 €	570 €	628 €	628 €
91↔93	89,4↔91,4		82	83	Y2G91-				517 €	570 €	628 €	628 €
93↔95	91,4↔93,4		84	85	Y2G93-				517 €	570 €	628 €	628 €
95↔97	93,4↔95,4		86	87	Y2G95-				517 €	570 €	628 €	628 €
97↔99	95,4↔97,4		88	89	Y2G97-				541 €	597 €	657 €	657 €
99↔101	97,4↔99,4		90	91	Y2G99-				541 €	597 €	657 €	657 €
101↔103	99,4↔101,4		92	93	Y2G101-				541 €	597 €	657 €	657 €
H 140↔220 L 50↔120				ESPECIAL	Y2GSP	+ 40 €	+ 40 €		675 €	744 €	818 €	818 €
FIJO PANEL / FIXO PAINEL												
	55,4↔57,4	57↔59	-	-	Y2FG57-				398 €	439 €	482 €	482 €
	57,4↔59,4	59↔61	-	-	Y2FG59-				398 €	439 €	482 €	482 €
	59,4↔61,4	61↔63	-	-	Y2FG61-				398 €	439 €	482 €	482 €
	63,4↔65,4	65↔67	-	-	Y2FG65-				424 €	466 €	513 €	513 €
	65,4↔67,4	67↔69	-	-	Y2FG67-				424 €	466 €	513 €	513 €
	67,4↔69,4	69↔71	-	-	Y2FG69-				424 €	466 €	513 €	513 €
	71,4↔73,4	73↔75	-	-	Y2FG73-				451 €	496 €	545 €	545 €
	73,4↔75,4	75↔77	-	-	Y2FG75-				451 €	496 €	545 €	545 €
	74,4↔76,4	76↔78	-	-	Y2FG76-				451 €	496 €	545 €	545 €
	75,4↔77,4	77↔79	-	-	Y2FG77-				451 €	496 €	545 €	545 €
	77,4↔79,4	79↔81	-	-	Y2FG79-				451 €	496 €	545 €	545 €
	79,4↔81,4	81↔83	-	-	Y2FG81-	+ 40 €	+ 40 €		451 €	496 €	545 €	545 €
	83,4↔85,4	85↔87	-	-	Y2FG85-				476 €	524 €	577 €	577 €
	85,4↔87,4	87↔89	-	-	Y2FG87-				476 €	524 €	577 €	577 €
	87,4↔89,4	89↔91	-	-	Y2FG89-				476 €	524 €	577 €	577 €
	89,4↔91,4	91↔93	-	-	Y2FG91-				476 €	524 €	577 €	577 €
	91,4↔93,4	93↔95	-	-	Y2FG93-				476 €	524 €	577 €	577 €
	93,4↔95,4	95↔97	-	-	Y2FG95-				476 €	524 €	577 €	577 €
	95,4↔97,4	97↔99	-	-	Y2FG97-				504 €	554 €	612 €	612 €
	97,4↔99,4	99↔101	-	-	Y2FG99-				504 €	554 €	612 €	612 €
	99,4↔101,4	101↔103	-	-	Y2FG101-				504 €	554 €	612 €	612 €
	115,4↔117,4	117↔119	-	-	Y2FG117-				504 €	554 €	612 €	612 €
	117,4↔119,4	119↔121	-	-	Y2FG119-				504 €	554 €	612 €	612 €
	H 100↔220 L 20↔140			ESPECIAL	Y2FGSP	+ 40 €	+ 40 €		624 €	688 €	757 €	757 €

EL FIJO ESPECIAL SE DEBE PEDIR CON LA MISMA ALTURA DE LA PUERTA / O FIXO ESPECIAL DEVE-SE PEDIR COM A MESMA ALTURA DA PORTA BARRA DE SUJECIÓN A PARED DE 150 CM. INCLUIDA.

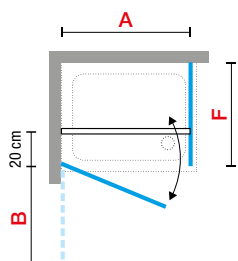
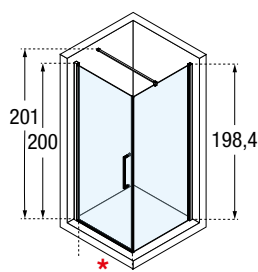

IMPORTANTE!
INDICAR EN PEDIDO SI EL PLATO ES SOBREELEVADO O A RAS DE SUELO
INDICAR NA ENCOMENDA SE A BASE E SOBRE ELEVADO O A NIVEL DO CHÃO

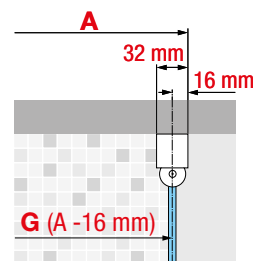



OPCIONAL



**JUNTA HORIZONTAL INFERIOR
PARA INSTALACIONES SIN KIT
ESTANCO**

Código	Precio / Preço
R55SPBOM01-TR	46 €



APERTURA INTERIOR - EXTERIOR

CRISTAL TEMPLADO / VIDRO TEMPERADO



Transparente
cod 1



Aqua
cod 2

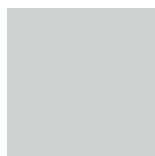

Satinado
Fosco
cod 4

COLORES PERFILES / CORES PERFÍS



Blanco mate
Branco mate
cod. U

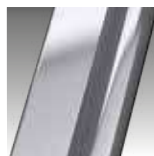

Silver
Abrillantado
cod. B



Cromo
cod K



Negro mate
cod H

YOUNG 2G



ANGULAR DE DOS PUERTAS ABATIBLES ANGULAR DE DUAS FOLHAS ABATÍVEIS

Medidas				Código	Selección Cristales Seleção Vidros			Selección de perfiles Seleção de perfis			
Medidas extensibilidad Medidas extensibilidade	Medidas extensibilidad para platos a ras de suelo	Entrada *	Espacio de apertura Espaço de abertura		1	2	4	U	B	K	H
A	G	*	B		Transparente	Aqua	Satinado Fosco	Blanco mate Branco mate	Silver Abrillantado	Cromo	Negro mate
57↔59	55,4↔57,4	69	49	Y22G57L-				448 €	493 €	543 €	543 €
59↔61	57,4↔59,4	72	51	Y22G59L-				448 €	493 €	543 €	543 €
61↔63	59,4↔61,4	75	53	Y22G61L-				448 €	493 €	543 €	543 €
65↔67	63,4↔65,4	81	57	Y22G65L-				448 €	493 €	543 €	543 €
67↔69	65,4↔67,4	84	59	Y22G67L-				471 €	518 €	571 €	571 €
69↔71	67,4↔69,4	87	61	Y22G69L-				471 €	518 €	571 €	571 €
72↔74	70,4↔72,4	91	64	Y22G72L-				471 €	518 €	571 €	571 €
74↔76	72,4↔74,4	94	66	Y22G74L-				471 €	518 €	571 €	571 €
76↔78	74,4↔76,4	96	68	Y22G76L-				471 €	518 €	571 €	571 €
77↔79	75,4↔77,4	98	69	Y22G77L-				495 €	544 €	599 €	599 €
79↔81	77,4↔79,4	101	71	Y22G79L-				495 €	544 €	599 €	599 €
81↔83	79,4↔81,4	103	73	Y22G81L-				495 €	544 €	599 €	599 €
85↔87	83,4↔85,4	109	77	Y22G85L-				495 €	544 €	599 €	599 €
87↔89	85,4↔87,4	112	79	Y22G87L-				517 €	570 €	628 €	628 €
89↔91	87,4↔89,4	115	81	Y22G89L-				517 €	570 €	628 €	628 €
91↔93	89,4↔91,4	117	83	Y22G91L-				517 €	570 €	628 €	628 €
95↔97	93,4↔95,4	124	87	Y22G95L-				517 €	570 €	628 €	628 €
97↔99	95,4↔97,4	127	89	Y22G97L-				541 €	597 €	657 €	657 €
99↔101	97,4↔99,4	130	91	Y22G99L-				541 €	597 €	657 €	657 €
101↔103	99,4↔101,4	133	93	Y22G101L-	541 €	597 €	657 €	657 €			
H 140↔220 L 30↔108			ESPECIAL	Y22GLSP	+ 40 €	+ 40 €	675 €	744 €	818 €	818 €	

PARA COMPONER UN ÁNGULO PEDIR 2 LATERALES PARA FORMAR UN ÁNGULO PEDIR DOIS LATERAIS

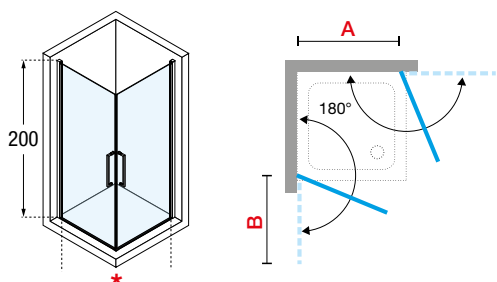

IMPORTANT!
INDICAR EN PEDIDO SI EL PLATO ES SOBREELEVADO O A RAS DE SUELO
INDICAR NA ENCOMENDA SE A BASE E SOBRE ELEVADO O A NIVEL DO CHÃO

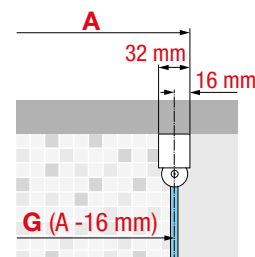



OPCIONAL



JUNTA HORIZONTAL INFERIOR
PARA INSTALACIONES SIN KIT
ESTANCO

Código	Precio / Preço
R55SPBOA01-TR	46 €

CRISTAL TEMPLADO / VIDRO TEMPERADO



Transparente
cod 1



Aqua
cod 2

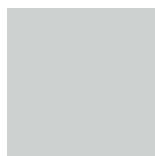

Satinado
Fosco
cod 4

COLORES PERFILES / CORES PERFÍS



Blanco mate
Branco mate
cod. U

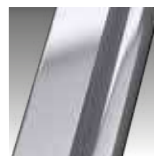

Silver
Abrillantado
cod. B



Cromo
cod K



Negro mate
cod H

YOUNG 1BS



FRONTAL PLEGABLE SIN GUIAS

PARA INSTALAR ENTRE PAREDES O CON FIJO LATERAL YOUNG F1B

FRONTAL DESDOBRÁVEL SEM GUIAS

PARA INSTALAR ENTRE PAREDES OU COM FIXO LATERAL YOUNG F1B

Medidas						Código	Derecha Direita	Izquierda Esquerda	Selección Cristales Seleção Vidros			Selección de perfiles Seleção de perfis			
Medidas extensibilidad Medidas extensibilidade	Medidas extensibilidad para platos a ras de suelo	Entre paredes	Entrada	Ingombro anta			D-	S-	1	2	4	U	B	K	H
con fijo com fijo									Transparente	Aqua	Satinado Fosco	Blanco mate Branco mate	Silver Abrillantado	Cromo	Negro mate
A	G	A1	*	B	B1										

PUERTA / PORTA															
58↔62	56,4↔60,4	57↔61	41	47	27	Y21BS57	D-	S-				729 €	802 €	883 €	883 €
68↔72	66,4↔70,4	67↔71	51	57	32	Y21BS67	D-	S-				758 €	834 €	917 €	917 €
73↔77	71,4↔75,4	72↔76	56	62	35	Y21BS72	D-	S-				758 €	834 €	917 €	917 €
78↔82	76,4↔80,4	77↔81	61	67	37	Y21BS77	D-	S-				787 €	866 €	953 €	953 €
83↔87	81,4↔85,4	82↔86	66	72	40	Y21BS82	D-	S-				787 €	866 €	953 €	953 €
88↔92	86,4↔90,4	87↔91	71	77	42	Y21BS87	D-	S-	+ 40 €	+ 40 €		815 €	898 €	988 €	988 €
95↔99	93,4↔97,4	94↔98	78	84	46	Y21BS94	D-	S-				815 €	898 €	988 €	988 €
98↔102	96,4↔100,4	97↔101	81	87	47	Y21BS97	D-	S-				843 €	928 €	1.021 €	1.021 €
108↔112	106,4↔110,4	107↔111	91	97	52	Y21BS107	D-	S-				843 €	928 €	1.021 €	1.021 €
116↔120	114,4↔118,4	115↔119	99	105	55	Y21BS115	D-	S-				872 €	959 €	1.057 €	1.057 €
118↔122	116,4↔120,4	117↔121	101	107	57	Y21BS117	D-	S-				872 €	959 €	1.057 €	1.057 €

FIJO LATERAL OPCIONAL															
57↔59	55,4↔57,4	-	-	-	-	Y2F1B57-						398 €	439 €	482 €	482 €
59↔61	57,4↔59,4	-	-	-	-	Y2F1B59-						398 €	439 €	482 €	482 €
65↔67	63,4↔65,4	-	-	-	-	Y2F1B65-						424 €	466 €	513 €	513 €
67↔69	65,4↔67,4	-	-	-	-	Y2F1B67-						424 €	466 €	513 €	513 €
69↔71	67,4↔69,4	-	-	-	-	Y2F1B69-						424 €	466 €	513 €	513 €
73↔75	71,4↔73,4	-	-	-	-	Y2F1B73-						451 €	496 €	545 €	545 €
75↔77	73,4↔75,4	-	-	-	-	Y2F1B75-						451 €	496 €	545 €	545 €
76↔78	74,4↔76,4	-	-	-	-	Y2F1B76-						451 €	496 €	545 €	545 €
77↔79	75,4↔77,4	-	-	-	-	Y2F1B77-						451 €	496 €	545 €	545 €
79↔81	77,4↔79,4	-	-	-	-	Y2F1B79-						451 €	496 €	545 €	545 €
81↔83	79,4↔81,4	-	-	-	-	Y2F1B81-	-	-	+ 40 €	+ 40 €		451 €	496 €	545 €	545 €
85↔87	83,4↔85,4	-	-	-	-	Y2F1B85-						476 €	524 €	577 €	577 €
87↔89	85,4↔87,4	-	-	-	-	Y2F1B87-						476 €	524 €	577 €	577 €
89↔91	87,4↔89,4	-	-	-	-	Y2F1B89-						476 €	524 €	577 €	577 €
91↔93	89,4↔91,4	-	-	-	-	Y2F1B91-						476 €	524 €	577 €	577 €
95↔97	93,4↔95,4	-	-	-	-	Y2F1B95-						476 €	524 €	577 €	577 €
97↔99	95,4↔97,4	-	-	-	-	Y2F1B97-						504 €	554 €	612 €	612 €
99↔101	97,4↔99,4	-	-	-	-	Y2F1B99-						504 €	554 €	612 €	612 €
101↔103	99,4↔101,4	-	-	-	-	Y2F1B101-						504 €	554 €	612 €	612 €
117↔119	115,4↔117,4	-	-	-	-	Y2F1B117-						504 €	554 €	612 €	612 €
119↔121	117,4↔119,4	-	-	-	-	Y2F1B119-						504 €	554 €	612 €	612 €
H 140↑220															
L 20↔120						ESPECIAL Y2F1BSP	-	-	+ 40 €	+ 40 €		624 €	688 €	757 €	757 €

EL FIJO ESPECIAL SE DEBE PEDIR CON LA MISMA ALTURA DE LA PUERTA. / O FIXO ESPECIAL DEVE-SE PEDIR COM A MESMA ALTURA DA PORTA
BARRA DE SUJECIÓN A PARED DE 150 CM. INCLUIDA / BARRA DE FIXAÇÃO Á PAREDE DE 150 CM. INCLUIDA

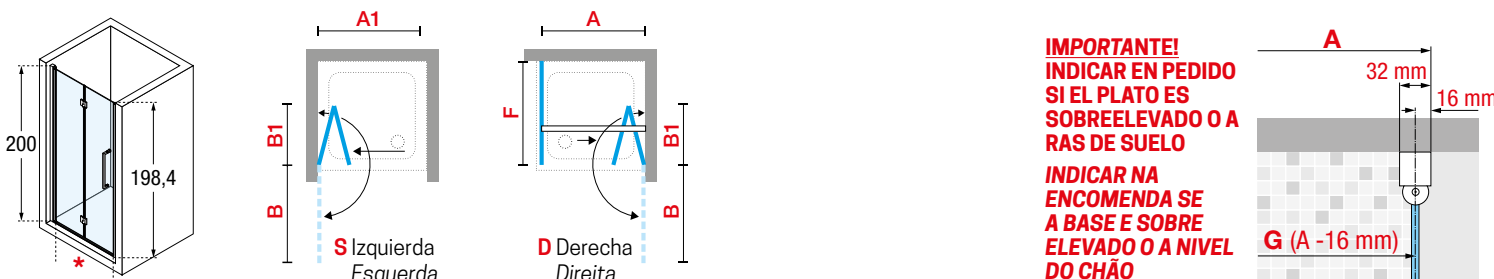



OPCIONAL



JUNTA HORIZONTAL INFERIOR
PARA INSTALACIONES SIN KIT
ESTANCO

Código	Precio / Preço
R55SPBOM01-TR	46 €



JUNTA VERTICAL PUERTA
JUNTA VERTICAL PORTA

CRISTAL TEMPLADO / VIDRO TEMPERADO



Transparente
cod 1



Aqua
cod 2



Satinado
Fosco
cod 4

COLORES PERFILES / CORES PERFÍS



Blanco mate
Branco mate
cod. U

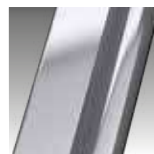

Silver
Abrillantado
cod. B



Cromo
cod K



Negro mate
cod H

YOUNG 2GS+F



200 cm



6 mm



2 cm



No reversible
puerta

Não

Reversível

porta



Reversible

Fijo

Reversível

Fixo



↑



Water drop icon

ANGULAR COMPUESTA POR UNA PUERTA PLEGABLE SIN GUÍAS Y UN FIJO LATERAL
ANGULAR COMPOSTO DE UMA PORTA DESDOBRÁVEL SEM GUIAS COM FIXO LATERAL

Medidas					Código	Derecha Direita	Izquierda Esquerda	Selección Cristales Seleção Vidros			Selección de perfiles Seleção de perfis			
Medidas extensibilidad Medidas extensibilidade	Medidas extensibilidad para platos a ras de suelo	Panel fijo lateral Painel fixo lateral	Entrada	Espacio de apertura Espaço de abertura		D-	S-	1	2	4	U	B	K	H
A	G	F	*	B B1				Transparente	Aqua	Satinado Fosco	Blanco mate Branco mate	Silver Abrillantado	Cromo	Negro mate

PUERTA / PORTA															
58↔60	56,4↔58,4		49	49	26	Y22GS57L	D-	S-				570 €	628 €	689 €	689 €
60↔62	58,4↔60,4		51	51	27	Y22GS59L	D-	S-				570 €	628 €	689 €	689 €
66↔68	64,4↔66,4		57	57	30	Y22GS65L	D-	S-				570 €	628 €	689 €	689 €
68↔70	66,4↔68,4		59	59	31	Y22GS67L	D-	S-				570 €	628 €	689 €	689 €
70↔72	68,4↔70,4		61	61	32	Y22GS69L	D-	S-				597 €	656 €	721 €	721 €
74↔76	72,4↔74,4		65	65	34	Y22GS73L	D-	S-				597 €	656 €	721 €	721 €
76↔78	74,4↔76,4		67	67	35	Y22GS75L	D-	S-				597 €	656 €	721 €	721 €
77↔79	75,4↔77,4		68	68	36	Y22GS76L	D-	S-				597 €	656 €	721 €	721 €
78↔80	76,4↔78,4		69	69	36	Y22GS77L	D-	S-				597 €	656 €	721 €	721 €
80↔82	78,4↔80,4		71	71	37	Y22GS79L	D-	S-				624 €	687 €	756 €	756 €
82↔84	80,4↔82,4		73	73	38	Y22GS81L	D-	S-				624 €	687 €	756 €	756 €
86↔88	84,4↔86,4		77	77	40	Y22GS85L	D-	S-	+ 40 €	+ 40 €		624 €	687 €	756 €	756 €
88↔90	86,4↔88,4		79	79	41	Y22GS87L	D-	S-				624 €	687 €	756 €	756 €
90↔92	88,4↔90,4		81	81	42	Y22GS89L	D-	S-				624 €	687 €	756 €	756 €
92↔94	90,4↔92,4		83	83	43	Y22GS91L	D-	S-				624 €	687 €	756 €	756 €
96↔98	94,4↔96,4		87	87	45	Y22GS95L	D-	S-				651 €	716 €	788 €	788 €
98↔100	96,4↔98,4		89	89	46	Y22GS97L	D-	S-				651 €	716 €	788 €	788 €
100↔102	98,4↔100,4		91	91	47	Y22GS99L	D-	S-				651 €	716 €	788 €	788 €
102↔104	100,4↔102,4		93	93	48	Y22GS101L	D-	S-				651 €	716 €	788 €	788 €
106↔108	104,4↔106,4		97	97	50	Y22GS105L	D-	S-				651 €	716 €	788 €	788 €
116↔118	114,4↔116,4		107	107	55	Y22GS115L	D-	S-				651 €	716 €	788 €	788 €
118↔120	116,4↔118,4		109	109	56	Y22GS117L	D-	S-				678 €	746 €	822 €	822 €
120↔122	118,4↔120,4		111	111	57	Y22GS119L	D-	S-				678 €	746 €	822 €	822 €

PANEL FIJO LATERAL															
-	55,4↔57,4	57↔59	-	-		Y2FG57-						398 €	439 €	482 €	482 €
-	57,4↔59,4	59↔61	-	-		Y2FG59-						398 €	439 €	482 €	482 €
-	59,4↔61,4	61↔63	-	-		Y2FG61-						398 €	439 €	482 €	482 €
-	63,4↔65,4	65↔67	-	-		Y2FG65-						424 €	466 €	513 €	513 €
-	65,4↔67,4	67↔69	-	-		Y2FG67-						424 €	466 €	513 €	513 €
-	67,4↔69,4	69↔71	-	-		Y2FG69-						424 €	466 €	513 €	513 €
-	71,4↔73,4	73↔75	-	-		Y2FG73-						451 €	496 €	545 €	545 €
-	73,4↔75,4	75↔77	-	-		Y2FG75-						451 €	496 €	545 €	545 €
-	74,4↔76,4	76↔78	-	-		Y2FG76-						451 €	496 €	545 €	545 €
-	75,4↔77,4	77↔79	-	-		Y2FG77-						451 €	496 €	545 €	545 €
-	77,4↔79,4	79↔81	-	-		Y2FG79-						451 €	496 €	545 €	545 €
-	79,4↔81,4	81↔83	-	-		Y2FG81-			+ 40 €	+ 40 €		451 €	496 €	545 €	545 €
-	83,4↔85,4	85↔87	-	-		Y2FG85-						476 €	524 €	577 €	577 €
-	85,4↔87,4	87↔89	-	-		Y2FG87-						476 €	524 €	577 €	577 €
-	87,4↔89,4	89↔91	-	-		Y2FG89-						476 €	524 €	577 €	577 €
-	89,4↔91,4	91↔93	-	-		Y2FG91-						476 €	524 €	577 €	577 €
-	91,4↔93,4	93↔95	-	-		Y2FG93-						476 €	524 €	577 €	577 €
-	93,4↔95,4	95↔97	-	-		Y2FG95-						476 €	524 €	577 €	577 €
-	95,4↔97,4	97↔99	-	-		Y2FG97-						504 €	554 €	612 €	612 €
-	97,4↔99,4	99↔101	-	-		Y2FG99-						504 €	554 €	612 €	612 €
-	99,4↔101,4	101↔103	-	-		Y2FG101-						504 €	554 €	612 €	612 €
-	115,4↔117,4	117↔119	-	-		Y2FG117-						504 €	554 €	612 €	612 €
-	117,4↔119,4	119↔121	-	-		Y2FG119-						504 €	554 €	612 €	612 €

H 100;220
L 20↔120
ESPECIAL **Y2FGSP** - - + 40 € + 40 € 624 € 688 € 757 € 757 €

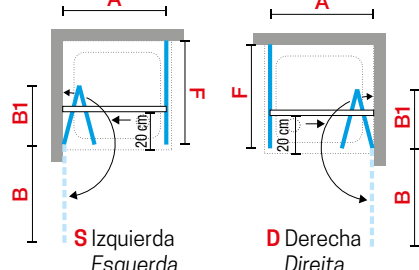
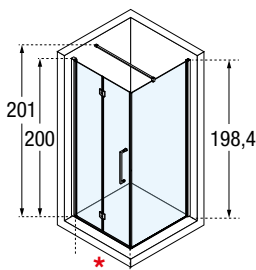

BARRA DE SUJECIÓN A PARED DE 150 CM. INCLUIDA
BARRA DE FIXAÇÃO Á PAREDE DE 150 CM. INCLUIDA

¡IMPORTANTE! INDICAR EN PEDIDO SI EL PLATO ES SOBREELEVADO O A RAS DE SUELO
INDICAR NA ENCOMENDA SE A BASE E SOBRE ELEVADO O A NIVEL DO CHÃO

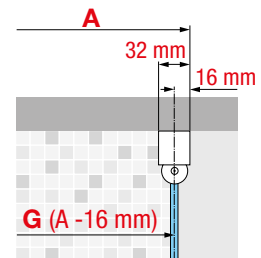



OPCIONAL



JUNTA HORIZONTAL INFERIOR
PARA INSTALACIONES SIN KIT
ESTANCO

Código	Precio / Preço
R55SPBOA01-TR	46 €



JUNTA VERTICAL PUERTA
JUNTA VERTICAL PORTA

CRISTAL TEMPLADO / VIDRO TEMPERADO



Transparente
cod 1



Aqua
cod 2



Satinado
Fosco
cod 4

COLORES PERFILES / CORES PERFÍS



Blanco mate
Branco mate
cod. U

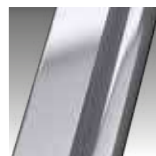

Silver
Abrillantado
cod. B



Cromo
cod K



Negro mate
cod H

YOUNG 2GS



ANGULAR DE DOS PUERTAS PLEGABLES SIN GUIAS ANGULAR DE DUAS PORTAS DESDOBRÁVEL SEM GUIAS

Medidas					Código	Derecha Direita	Izquierda Esquerda	Selección Cristales Seleção Vidros			Selección de perfiles Seleção de perfis			
Medidas extensibilidad Medidas extensibilidade	Medidas extensibilidad para platos a ras de suelo	Entrada	Espacio de apertura Espaço de abertura			D-	S-	1	2	4	U	B	K	H
A	G	*	B	B1				Transparente	Aqua	Satinado Fosco	Blanco mate Branco mate	Silver Abrillantado	Cromo	Negro mate
57↔59	55,4↔57,4	69	49	26	Y22GS57L	D-	S-				570 €	628 €	689 €	689 €
59↔61	57,4↔59,4	72	51	27	Y22GS59L	D-	S-				570 €	628 €	689 €	689 €
65↔67	63,4↔65,4	81	57	30	Y22GS65L	D-	S-				570 €	628 €	689 €	689 €
67↔69	65,4↔67,4	83	59	31	Y22GS67L	D-	S-				570 €	628 €	689 €	689 €
69↔71	67,4↔69,4	86	61	32	Y22GS69L	D-	S-				597 €	656 €	721 €	721 €
73↔75	71,4↔73,4	92	65	34	Y22GS73L	D-	S-				597 €	656 €	721 €	721 €
75↔77	73,4↔75,4	95	67	35	Y22GS75L	D-	S-				597 €	656 €	721 €	721 €
76↔78	74,4↔76,4	96	68	36	Y22GS76L	D-	S-				597 €	656 €	721 €	721 €
77↔79	75,4↔77,4	98	69	36	Y22GS77L	D-	S-				597 €	656 €	721 €	721 €
79↔81	77,4↔79,4	100	71	37	Y22GS79L	D-	S-				624 €	687 €	756 €	756 €
81↔83	79,4↔81,4	103	73	38	Y22GS81L	D-	S-				624 €	687 €	756 €	756 €
85↔87	83,4↔85,4	109	77	40	Y22GS85L	D-	S-	+ 40 €	+ 40 €		624 €	687 €	756 €	756 €
87↔89	85,4↔87,4	112	79	41	Y22GS87L	D-	S-				624 €	687 €	756 €	756 €
89↔91	87,4↔89,4	115	81	42	Y22GS89L	D-	S-				624 €	687 €	756 €	756 €
91↔93	89,4↔91,4	117	83	43	Y22GS91L	D-	S-				624 €	687 €	756 €	756 €
95↔97	93,4↔95,4	123	87	45	Y22GS95L	D-	S-				651 €	716 €	788 €	788 €
97↔99	95,4↔97,4	126	89	46	Y22GS97L	D-	S-				651 €	716 €	788 €	788 €
99↔101	97,4↔99,4	129	91	47	Y22GS99L	D-	S-				651 €	716 €	788 €	788 €
101↔103	99,4↔101,4	132	93	48	Y22GS101L	D-	S-				651 €	716 €	788 €	788 €
105↔107	103,4↔105,4	141	97	50	Y22GS105L	D-	S-				651 €	716 €	788 €	788 €
115↔117	113,4↔115,4	151	107	55	Y22GS115L	D-	S-				651 €	716 €	788 €	788 €
117↔119	115,4↔117,4	154	109	56	Y22GS117L	D-	S-				678 €	746 €	822 €	822 €
119↔121	117,4↔119,4	157	111	57	Y22GS119L	D-	S-				678 €	746 €	822 €	822 €

PARA COMPONER UN ÁNGULO PEDIR 2 LATERALES PARA FORMAR UN ÂNGULO PEDIR DOIS LATERAIS

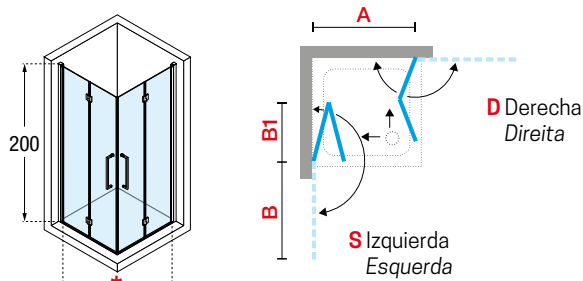

¡IMPORTANTE!
INDICAR EN PEDIDO SI EL PLATO ES SOBREELEVADO O A RAS DE SUELO
INDICAR NA ENCOMENDA SE A BASE E SOBRE ELEVADO O A NIVEL DO CHÃO

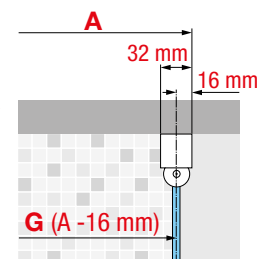



OPCIONAL



JUNTA HORIZONTAL INFERIOR
PARA INSTALACIONES SIN KIT
ESTANCO

Código	Precio / Preço
R55SPBOA01-TR	46 €



JUNTA VERTICAL PUERTA
JUNTA VERTICAL PORTA

CRISTAL TEMPLADO / VIDRO TEMPERADO



Transparente
cod 1



Aqua
cod 2



Satinado
Fosco
cod 4

COLORES PERFILES / CORES PERFÍS



Blanco mate
Branco mate
cod. U

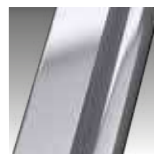

Silver
Abrillantado
cod. B



Cromo
cod K



Negro mate
cod H



ANGULAR DE DOS PUERTAS ABATIBLES + DOS FIJOS
RESGUARDO PARA DUCHE ANGULAR COMPOSTO POR DUAS PORTAS ABATIVAS E DOIS FIXOS

Medidas					Código	Selección Cristales Seleção Vidros			Selección de perfiles Seleção de perfis			
Medidas extensibilidad Medidas extensibilidade	Medidas extensibilidad para platos a ras de suelo	fijo panel en línea Fixo painel em linha	Entrada	Espacio de apertura Espaço de abertura		1	2	4	U	B	K	H
A	G	F1	*	B		Transparente	Aqua	Satinado Fosco	Blanco mate Branco mate	Silver Abrillantado	Cromo	Negro mate
57↔59	55,4↔57,4	27	37	27	Y2A57L-				471 €	518 €	571 €	571 €
59↔61	57,4↔59,4	27	39	29	Y2A59L-				471 €	518 €	571 €	571 €
61↔63	59,4↔61,4	27	42	31	Y2A61L-				471 €	518 €	571 €	571 €
65↔67	63,4↔65,4	27	48	35	Y2A65L-				471 €	518 €	571 €	571 €
67↔69	65,4↔67,4	27	51	37	Y2A67L-				493 €	543 €	598 €	598 €
69↔71	67,4↔69,4	27	54	39	Y2A69L-				493 €	543 €	598 €	598 €
73↔75	71,4↔73,4	35	49	35	Y2A73L-				493 €	543 €	598 €	598 €
75↔77	73,4↔75,4	35	51	37	Y2A75L-				493 €	543 €	598 €	598 €
76↔78	74,4↔76,4	35	52	38	Y2A76L-				493 €	543 €	598 €	598 €
77↔79	75,4↔77,4	35	54	39	Y2A77L-				516 €	569 €	625 €	625 €
79↔81	77,4↔79,4	35	57	41	Y2A79L-				516 €	569 €	625 €	625 €
81↔83	79,4↔81,4	35	59	43	Y2A81L-				516 €	569 €	625 €	625 €
85↔87	83,4↔85,4	43	54	39	Y2A85L-				516 €	569 €	625 €	625 €
87↔89	85,4↔87,4	43	57	41	Y2A87L-				516 €	569 €	625 €	625 €
89↔91	87,4↔89,4	43	60	43	Y2A89L-				540 €	596 €	655 €	655 €
91↔93	89,4↔91,4	43	62	45	Y2A91L-				540 €	596 €	655 €	655 €
95↔97	93,4↔95,4	43	69	49	Y2A95L-				540 €	596 €	655 €	655 €
97↔99	95,4↔97,4	43	72	51	Y2A97L-				540 €	596 €	655 €	655 €
99↔101	97,4↔99,4	43	75	53	Y2A99L-				540 €	596 €	655 €	655 €
101↔103	99,4↔101,4	43	77	55	Y2A101L-				540 €	596 €	655 €	655 €
H 140†220 L 57↔118				EPECIAL	Y2ALSP	+ 40 €	+ 40 €	+ 40 €	697 €	766 €	845 €	845 €

PARA COMPONER UN ÁNGULO PEDIR 2 LATERALES
PARA FORMAR UN ÂNGULO PEDIR DOIS LATERAIS

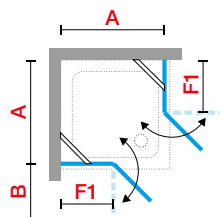
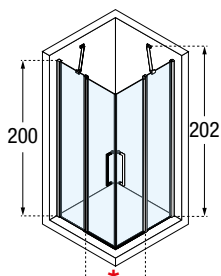

OPCIONAL

JUNTA HORIZONTAL INFERIOR
 PARA INSTALACIONES SIN KIT
 ESTANCO

Código	Precio / Preço
R55SPBOA01-TR	46 €

¡IMPORTANTE!
INDICAR EN PEDIDO
SI EL PLATO ES
SOBREELEVADO O A
RAS DE SUELO
INDICAR NA
ENCOMENDA SE
A BASE E SOBRE
ELEVADO O A NIVEL
DO CHÃO

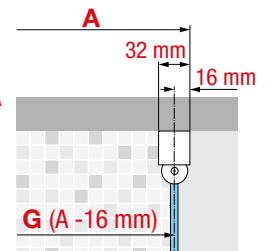



CRISTAL TEMPLADO / VIDRO TEMPERADO



Transparente
cod 1



Aqua
cod 2

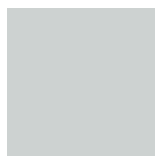

Satinado
Fosco
cod 4

COLORES PERFILES / CORES PERFÍS



Blanco mate
Branco mate
cod. U

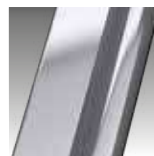

Silver
Abrillantado
cod. B



Cromo
cod K



Negro mate
cod H

YOUNG R



MAMPARA SEMICIRCULAR DE UNA PUERTA ABATIBLE + DOS FIJOS. PARA PLATO DE DUCHA SWIM
RESGUARDO SEMICIRCULAR DE UMA PORTA ABATÍVEL + DUAS FÍXAS. PARA BASE DE CHUVEIRO SWIM



CRISTAL TEMPLADO VIDRO TEMPERADO



Transparente
cod 1

Aqua
cod 2

COLORES PERFILES CORES PERFÍS



Blanco mate
Branco mate
cod. U

Silver
Abrillantado
cod. B



Cromo
cod K

Negro mate
cod H

Medidas						Código	Selección Cristales Seleção Vidros		Selección de perfiles Seleção de perfis			
Medidas extensibilidad Medidas extensibilidade	Medidas extensibilidad para platos a ras de suelo	fijo panel en línea Fixo painel em linha	Entrada	Espacio de apertura Espaço de abertura		1	2	U	B	K	H	
A	G	F1 F2	*	B		Transparente	Aqua	Blanco mate Branco mate	Silver Abrillantado	Cromo	Negro mate	
67,5↔69,5 x 87,5↔89,5	65,9↔67,9 x 85,9↔87,9	30 49	48	49	Y2R1A7090-			1.377 €	1.515 €	1.667 €	1.667 €	
77,5↔79,5 x 97,5↔99,5	75,9↔77,9 x 95,9↔97,9	40 59	48	49	Y2R1A80100-	+80 €		1.377 €	1.515 €	1.667 €	1.667 €	
77,5↔79,5 x 117,5↔119,5	75,9↔77,9 x 115,9↔117,9	40 79	48	49	Y2R1A80120-			1.377 €	1.515 €	1.667 €	1.667 €	

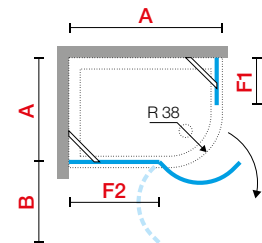
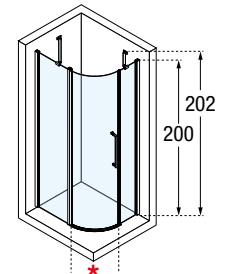

2 BARRAS ESTABILIZADORAS INCLUIDAS DE SERIE

OPCIONAL

	JUNTA HORIZONTAL INFERIOR PARA INSTALACIONES SIN KIT ESTANCO
Código	Precio / Preço
R55SPBOR11-TR	57 €

¡IMPORTANTE!
INDICAR EN PEDIDO SI EL PLATO ES SOBREELEVADO O A RAS DE SUELO

INDICAR NA ENCOMENDA SE A BASE É SOBRE ELEVADO O A NÍVEL DO CHÃO

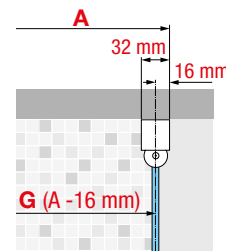

YOUNG R1



MAMPARA SEMICIRCULAR DE UNA PUERTA ABATIBLE + DOS FIJOS
RESGUARDO SEMICIRCULAR DE UMA PORTA ABATÍVEL + DUAS FÍXAS



CRISTAL TEMPLADO VIDRO TEMPERADO



Transparente
cod 1

Aqua
cod 2

COLORES PERFILES CORES PERFIS



Blanco mate
Branco mate
cod. U

Silver
Abrillantado
cod. B



Cromo
cod K

Negro mate
cod H

Medidas						Código	Selección Cristales Seleção Vidros		Selección de perfiles Seleção de perfis			
Medidas extensibilidad Medidas extensibilidade	Medidas extensibilidad para platos a ras de suelo	Fijo panel en línea Fixo painel em linha	Entrada	Espacio de apertura Espaço de abertura			1	2	U	B	K	H
A	G	F1	F2	*	B		Transparente	Aqua	Blanco mate Branco mate	Silver Abrillantado	Cromo	Negro mate
77,5↔79,5	75,9↔77,9	22	23	72	73	Y2R1A80-			1.377 €	1.515 €	1.667 €	1.667 €
87,5↔89,5	85,9↔87,9	32	33	72	73	Y2R1A90-		+ 80 €	1.377 €	1.515 €	1.667 €	1.667 €
97,5↔99,5	95,9↔97,9	42	43	72	73	Y2R1A100-			1.377 €	1.515 €	1.667 €	1.667 €

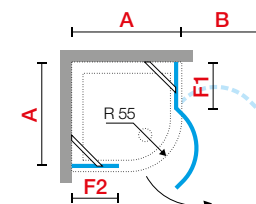
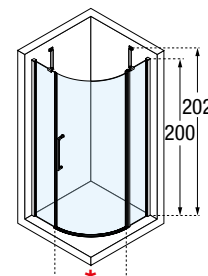

2 BARRAS ESTABILIZADORAS INCLUIDAS DE SERIE

OPCIONAL

	JUNTA HORIZONTAL INFERIOR PARA INSTALACIONES SIN KIT ESTANCO
Código	Precio / Preço
R55SPBOR11-TR	57 €

¡IMPORTANTE!
INDICAR EN PEDIDO
SI EL PLATO ES
SOBREELEVADO O A
RAS DE SUELO

**INDICAR NA
ENCOMENDA SE
A BASE E SOBRE
ELEVADO O A NIVEL
DO CHÃO**

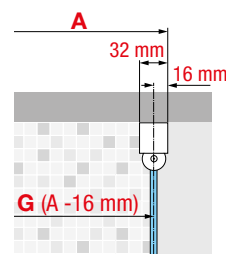

Construcción del código:
Construção do código

Código

+

Cristales
Vidros

+

Perfiles
Perfis

=

Código completo del producto
Código completo do produto

YOUNG R2



MAMPARA SEMICIRCULAR DE DOS PUERTAS ABATIBLES + DOS FIJOS
RESGUARDO SEMICIRCULAR DE DUAS PORTAS ABATÍVEIS + DUAS FIXAS



CRISTAL TEMPLADO VIDRO TEMPERADO



Transparente
cod 1

Aqua
cod 2



Satinado
Fosco
cod 4

COLORES PERFILES CORES PERFÍS



Blanco mate
Branco mate
cod. U

Silver
abrigantado
cod. B



Cromo
cod K

Negro mate
cod H

Medidas					Código	Selección Cristales Seleção Vidros			Selección de perfiles Seleção de perfis			
Medidas extensibilidad Medidas extensibilidade	Medidas extensibilidad para platos a ras de suelo	fijo panel en línea Fixo painel em linha	Entrada	Espacio de apertura Espaço de abertura		1	2	4	U	B	K	H
A	G	F1	*	B		Transparente	Aqua	Satinado Fosco	Blanco mate Branco mate	Silver Abrigantado	Cromo	Negro mate
77,5↔79,5	75,9↔77,9	22	71	38	Y2R80-				1.377 €	1.515 €	1.667 €	1.667 €
87,5↔89,5	85,9↔87,9	32	71	38	Y2R90-		+ 80 €	+ 80 €	1.377 €	1.515 €	1.667 €	1.667 €
97,5↔99,5	95,9↔97,9	42	71	38	Y2R100-				1.377 €	1.515 €	1.667 €	1.667 €

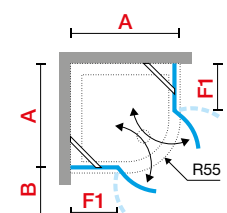
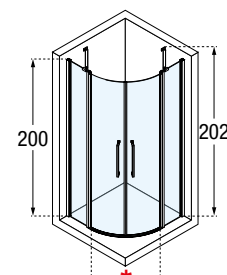

2 BARRAS ESTABILIZADORAS INCLUIDAS DE SERIE

OPCIONAL



JUNTA HORIZONTAL INFERIOR
PARA INSTALACIONES SIN KIT ESTANCO

Código	Precio / Preço
R55SPBOR01-TR	57 €

¡IMPORTANTE!
INDICAR EN PEDIDO SI EL PLATO ES SOBREELEVADO O A RAS DE SUELO

INDICAR NA ENCOMENDA SE A BASE E SOBRE ELEVADO O A NIVEL DO CHÃO

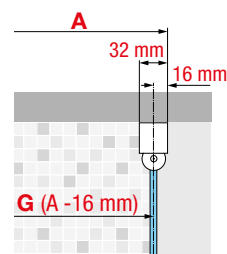

YOUNG R2 LUX



MAMPARA SEMICIRCULAR DE DOS PUERTAS ABATIBLES
RESGUARDO SEMICIRCULAR DE DUAS PORTAS ABATÍVEIS



CRISTAL TEMPLADO VIDRO TEMPERADO



Transparente
cod 1

Aqua
cod 2

COLORES PERFILES CORES PERFIS



Blanco mate
Branco mate
cod. U

Silver
Abrrillantado
cod. B



Cromo
cod K

Negro mate
cod H

Medidas				Código	Selección Cristales Seleção Vidros		Selección de perfiles Seleção de perfis			
Medidas extensibilidad Medidas extensibilidade	Medidas extensibilidad para platos a ras de suelo	Entrada	Espacio de apertura Espaço de abertura		1	2	U	B	K	H
A	G	*	B		Transparente	Aqua	Blanco mate Branco mate	Silver Abrrillantado	Cromo	Negro mate
77,5↔79,5	75,9↔77,9	98	56	Y2R280-			1.445 €	1.590 €	1.749 €	1.749 €
87,5↔89,5	85,9↔87,9	112	66	Y2R290-		+ 80 €	1.445 €	1.590 €	1.749 €	1.749 €
97,5↔99,5	95,9↔97,9	126	76	Y2R2100-			1.445 €	1.590 €	1.749 €	1.749 €

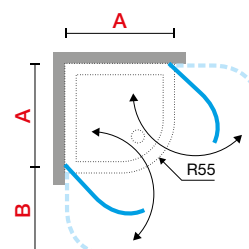
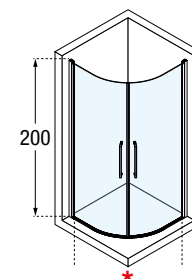

OPCIONAL



JUNTA HORIZONTAL INFERIOR
PARA INSTALACIONES SIN KIT ESTANCO

Código	Precio / Preço
R55SPBOR01-TR	57 €

¡IMPORTANTE!
INDICAR EN PEDIDO SI EL PLATO ES SOBREELEVADO O A RAS DE SUELO
INDICAR NA ENCOMENDA SE A BASE E SOBRE ELEVADO O A NIVEL DO CHÃO

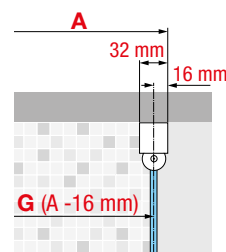

Construcción del código:
Construção do código

Código

+

Cristales
Vidros

+

Perfiles
Perfis

= Código completo del producto
Código completo do produto

YOUNG 2AS



ANGULAR DE DOS PUERTAS PLEGABLES SIN GUIAS ANGULAR DE DUAS PORTAS DESDOBRÁVEL SEM GUIAS

Medidas							Código	Derecha Direita	Izquierda Esquerda	Selección Cristales Seleção Vidros		Selección de perfiles Seleção de perfis			
Medidas extensibilidad Medidas extensibilidade	Medidas extensibilidad para platos a ras de suelo	Hojas		Entrada	Espacio de apertura Espaço de abertura	Espacio de apertura Espaço de abertura				D-	S-	1	2	U	B
A	G	A1	A2				*	B	B1						
57↔59	55,4↔57,4	32	24	69	52	32	Y22AS57L	D-	S-	Transparente	Aqua	Blanco mate Branco mate	Silver Abrillan- tado	Cromo	Negro mate
59↔61	57,4↔59,4	33	25	72	54	33	Y22AS59L	D-	S-			718 €	788 €	863 €	863 €
65↔67	63,4↔65,4	36	28	81	60	36	Y22AS65L	D-	S-			739 €	808 €	884 €	884 €
67↔69	65,4↔67,4	37	29	83	62	37	Y22AS67L	D-	S-			739 €	808 €	884 €	884 €
69↔71	67,4↔69,4	38	30	86	64	38	Y22AS69L	D-	S-			739 €	808 €	884 €	884 €
73↔75	71,4↔73,4	40	32	92	68	40	Y22AS73L	D-	S-			752 €	822 €	899 €	899 €
75↔77	73,4↔75,4	41	33	95	70	41	Y22AS75L	D-	S-			752 €	822 €	899 €	899 €
76↔78	74,4↔76,4	42	33	96	71	42	Y22AS76L	D-	S-			752 €	822 €	899 €	899 €
77↔79	75,4↔77,4	42	34	97	72	42	Y22AS77L	D-	S-			752 €	822 €	899 €	899 €
79↔81	77,4↔79,4	43	35	100	74	43	Y22AS79L	D-	S-			752 €	822 €	899 €	899 €
81↔83	79,4↔81,4	44	36	103	76	44	Y22AS81L	D-	S-			773 €	843 €	919 €	919 €
85↔87	83,4↔85,4	46	38	109	80	46	Y22AS85L	D-	S-	+ 40 €		773 €	843 €	919 €	919 €
87↔89	85,4↔87,4	47	39	112	82	47	Y22AS87L	D-	S-			773 €	843 €	919 €	919 €
89↔91	87,4↔89,4	48	40	115	84	48	Y22AS89L	D-	S-			773 €	843 €	919 €	919 €
91↔93	89,4↔91,4	49	41	117	86	49	Y22AS91L	D-	S-			779 €	856 €	940 €	940 €
95↔97	93,4↔95,4	51	43	123	90	51	Y22AS95L	D-	S-			779 €	856 €	940 €	940 €
97↔99	95,4↔97,4	52	44	126	92	52	Y22AS97L	D-	S-			779 €	856 €	940 €	940 €
99↔101	97,4↔99,4	53	45	129	94	53	Y22AS99L	D-	S-			779 €	856 €	940 €	940 €
101↔103	99,4↔101,4	54	46	131	96	54	Y22AS101L	D-	S-			800 €	878 €	961 €	961 €
105↔107	103,4↔105,4	56	48	137	100	56	Y22AS105L	D-	S-			800 €	878 €	961 €	961 €
115↔117	113,4↔115,4	61	53	151	110	61	Y22AS115L	D-	S-			822 €	899 €	983 €	983 €
117↔119	115,4↔117,4	62	54	154	112	62	Y22AS117L	D-	S-			822 €	899 €	983 €	983 €
119↔121	117,4↔119,4	63	55	157	114	63	Y22AS119L	D-	S-			822 €	899 €	983 €	983 €

OPCIONAL



JUNTA HORIZONTAL INFERIOR
PARA INSTALACIONES SIN KIT
ESTANCO

Code	Price
R55SPBOM01-TR	40 €

PARA COMPONER UN ÁNGULO PEDIR 2 LATERALES / FORMAR UM ÂNGULO PEDINDO DOIS LATERAIS (LADO DERECHO + LADO IZQUIERDO)

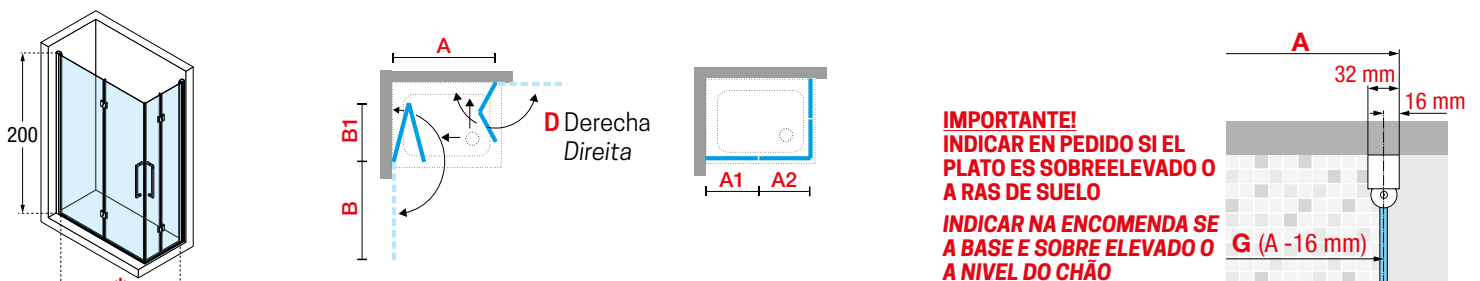

200  Construcción del código: **Código** + **Izquierda / Derecha** / **Esquerda / Direita** + **Cristales** / **Vidros** + **Perfiles** / **Perfis** = Código completo del producto / Código completo do produto



JUNTA VERTICAL PUERTA
JUNTA VERTICAL PORTA

CRISTAL TEMPLADO / VIDRO TEMPERADO



Transparente
cod 1



Aqua
cod 2

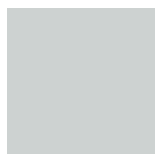

Satinado
Fosco
cod 4

COLORES PERFILES / CORES PERFÍS



Blanco mate
Branco mate
cod. U

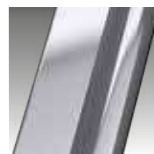

Silver
Abrillantado
cod. B



Cromo
cod K



Negro mate
cod H

YOUNG 3AS



ANGULAR DE DOS PUERTAS PLEGABLES SIN GUIAS
ANGULAR DE DUAS PORTAS DESDOBRÁVEL SEM GUIAS

Medidas								Código	Derecha Direita	Izquierda Esquerda	Selección Cristales Seleção Vidros		Selección de perfiles Seleção de perfis			
Medidas extensibilidad Medidas extensibilidade	Medidas extensibilidad para platos a ras de suelo	Hojas			Entrada	Espacio de apertura Espaço de abertura	Espacio de apertura Espaço de abertura				D-	S-	1	2	U	B
A	G	F1	A1	A2				*	B	B1						
117↔119	115,4↔117,4	22	50	46	131	95	50	Y23AS117L	D-	S-	+ 40 €		1.002 €	1.107 €	1.218 €	1.218 €
119↔121	117,4↔119,4	22	51	47	134	97	51	Y23AS119L	D-	S-		1.002 €	1.107 €	1.218 €	1.218 €	
121↔123	119,4↔121,4	22	52	48	137	99	52	Y23AS121L	D-	S-		1.002 €	1.107 €	1.218 €	1.218 €	
125↔127	123,4↔125,4	22	54	50	143	103	54	Y23AS125L	D-	S-		1.002 €	1.107 €	1.218 €	1.218 €	
127↔129	125,4↔127,4	22	55	51	145	105	55	Y23AS127L	D-	S-		1.002 €	1.107 €	1.218 €	1.218 €	
129↔131	127,4↔129,4	22	56	52	148	107	56	Y23AS129L	D-	S-		1.002 €	1.107 €	1.218 €	1.218 €	
131↔133	129,4↔131,4	22	57	53	151	109	57	Y23AS131L	D-	S-		1.030 €	1.134 €	1.246 €	1.246 €	
135↔137	133,4↔135,4	26	57	53	151	109	57	Y23AS135L	D-	S-		1.030 €	1.134 €	1.246 €	1.246 €	
137↔139	135,4↔137,4	28	57	53	151	109	57	Y23AS137L	D-	S-		1.038 €	1.142 €	1.253 €	1.253 €	
139↔141	137,4↔139,4	30	57	53	151	109	57	Y23AS139L	D-	S-		1.044 €	1.149 €	1.260 €	1.260 €	
141↔143	139,4↔141,4	32	57	53	151	109	57	Y23AS141L	D-	S-		1.052 €	1.155 €	1.267 €	1.267 €	
145↔147	141,4↔145,4	36	57	53	151	109	57	Y23AS145L	D-	S-		1.058 €	1.163 €	1.274 €	1.274 €	
147↔149	145,4↔147,4	38	57	53	151	109	57	Y23AS147L	D-	S-		1.065 €	1.169 €	1.288 €	1.288 €	
149↔151	147,4↔149,4	40	57	53	151	109	57	Y23AS149L	D-	S-		1.065 €	1.169 €	1.288 €	1.288 €	
151↔153	149,4↔151,4	42	57	53	151	109	57	Y23AS151L	D-	S-		1.073 €	1.177 €	1.295 €	1.295 €	
155↔157	153,4↔155,4	46	57	53	151	109	57	Y23AS155L	D-	S-		1.079 €	1.184 €	1.302 €	1.302 €	
157↔159	155,4↔157,4	48	57	53	151	109	57	Y23AS157L	D-	S-		1.085 €	1.197 €	1.317 €	1.317 €	
159↔161	157,4↔159,4	50	57	53	151	109	57	Y23AS159L	D-	S-		1.085 €	1.197 €	1.317 €	1.317 €	

OPCIONAL



JUNTA HORIZONTAL INFERIOR
PARA INSTALACIONES SIN KIT ESTANCO

Code	Price
R55SPBOM01-TR	40 €

PARA COMPONER UN ÁNGULO PEDIR 2 LATERALES / FORMAR UM ÂNGULO PEDINDO DOIS LATERAIS (LADO DERECHO + LADO IZQUIERDO)

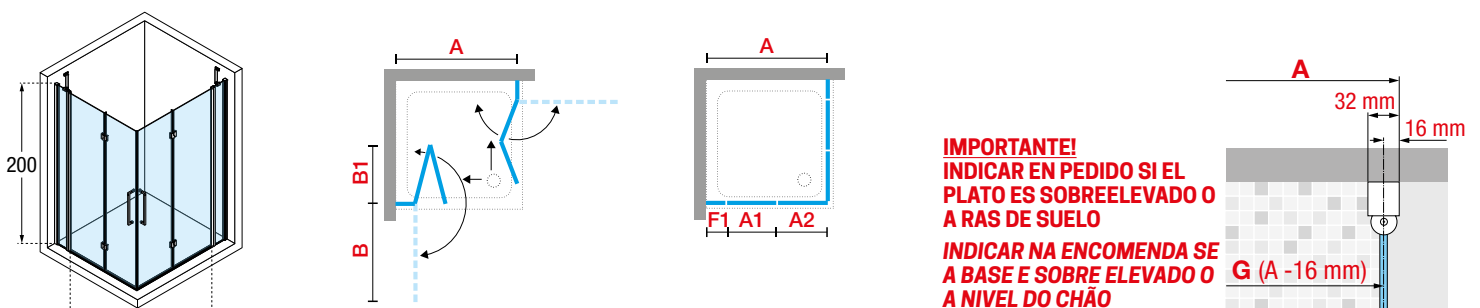

202 Construcción del código: **Código** + **Izquierda / Derecha** / **Esquerda / Direita** + **Cristales** / **Vidros** + **Perfiles** / **Perfis** = Código completo del producto / Código completo do produto



JUNTA VERTICAL PUERTA
JUNTA VERTICAL PORTA

CRISTAL TEMPLADO / VIDRO TEMPERADO



Transparente
cod 1



Aqua
cod 2



Satinado
Fosco
cod 4

COLORES PERFILES / CORES PERFÍS



Blanco mate
Branco mate
cod. U

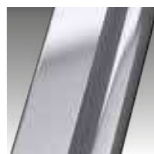

Silver
Abrillantado
cod. B



Cromo
cod K



Negro mate
cod H

YOUNG F SPECIAL 2

PANEL FIJO / COMPATIBLE CON YOUNG G
 PAINEL FIXO / COMPATÍVEL COM PORTA YOUNG G



CRISTAL TEMPLADO VIDRO TEMPERADO



Transparente
cod 1

Aqua
cod 2



Satinado
Fosco
cod 4

COLORES PERFILES CORES PERFÍS



Blanco mate
Branco mate
cod. U

Silver
abrigantado
cod. B



Cromo
cod K

Negro mate
cod H

Medidas	Código	Selección Cristales Selecção Vidros			Selección de perfiles Selecção de perfis			
		1	2	4	U	B	K	H
Medidas extensibilidad Medidas extensibilidade								
con fijo com fixo								
A		Transparente	Aqua	Satinado Fosco	Blanco mate Branco mate	Silver Abrigantado	Cromo	Negro mate
H 155±200 L 38↔120	Y2F2SP	+ 40 €	+ 40 €	591 €	652 €	718 €	718 €	

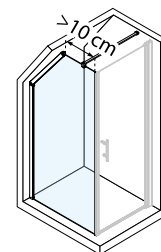

S Izquierda
Esquerda

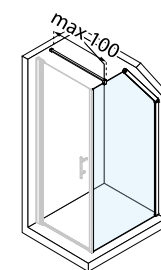

D Derecha
Direita

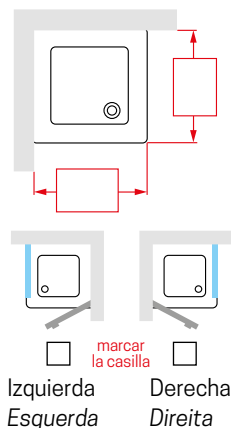
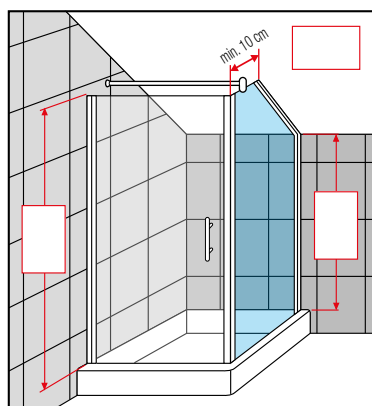

PARA MÁS OPCIONES DE PANELES FIJOS ESPECIALES, CONSULTAR LA TARIFA "AREA DE PROYECTOS"
PARA MAIS FIXOS ESPECIAIS, CONSULTAR A TARIFA "AREA DE PROYECTOS"



YOUNG F SPECIAL 3

PANEL FIJO / COMPATIBLE CON YOUNG G
 PAINEL FIXO / COMPATÍVEL COM PORTA YOUNG G



CRISTAL TEMPLADO VIDRO TEMPERADO



Transparente
cod 1



Aqua
cod 2



Satinado
Fosco
cod 4

COLORES PERFILES CORES PERFIS



Blanco mate
Branco mate
cod. U



Silver
abrilantado
cod. B



Cromo
cod K



Negro mate
cod H

Medidas	Código	Selección Cristales Seleção Vidros			Selección de perfiles Seleção de perfis			
		1	2	4	U	B	K	H
Medidas extensibilidad Medidas extensibilidade								
con fijo com fixo								
A		Transparente	Aqua	Satinado Fosco	Blanco mate Branco mate	Silver Abrilantado	Cromo	Negro mate
H 140↕200 L 60↔120	Y2F3SP	+ 40 €	+ 40 €	639 €	703 €	773 €	773 €	

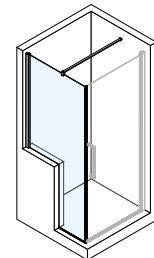

S Izquierda
Esquerda

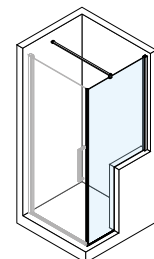

D Derecha
Direita

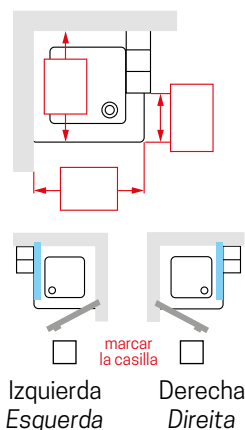
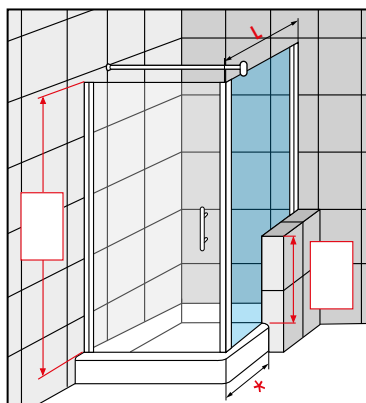

LA MEDIDA * DEBE SER SUPERIOR A 1/3 DE LA MEDIDA DE LUZ Y NO INFERIOR A 20 CM

PARA MÁS OPCIONES DE PANELES FIJOS ESPECIALES, CONSULTAR LA TARIFA "AREA DE PROYECTOS"
 PARA MAIS FIXOS ESPECIAIS, CONSULTAR A TARIFA "AREA DE PROYECTOS"

Construcción del código: Código + Cristales Vidros + Perfiles Perfis = Código completo del producto
 Construção do código

YOUNG F SPECIAL 4



6 mm



2 cm



PANEL FIJO / COMPATIBLE CON YOUNG 1B, 1BS, 2P E G+F EN LINEA
PAINEL FIXO / COMPATÍVEL COM PORTA YOUNG 1B, 1BS, 2P E G+F EN LINEA



CRISTAL TEMPLADO VIDRO TEMPERADO



Transparente
cod 1



Aqua
cod 2



Satinado
Fosco
cod 4

COLORES PERFILES CORES PERFÍS



Blanco mate
Branco mate
cod. U



Silver
abrillantado
cod. B



Cromo
cod K



Negro mate
cod H

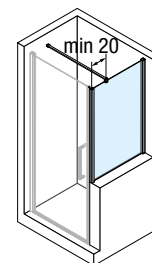

Medidas	Código	Selección Cristales Seleção Vidros			Selección de perfiles Seleção de perfis			
		1	2	4	U	B	K	H
Medidas extensibilidad Medidas extensibilidade								
con fijo com fixo								
A		Transparente	Aqua	Satinado Fosco	Blanco mate Branco mate	Silver Abrillantado	Cromo	Negro mate
H 65↕200 L 20↔120	Y2F4SP	+ 40 €	+ 40 €	557 €	613 €	673 €	673 €	

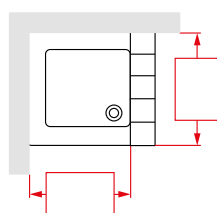
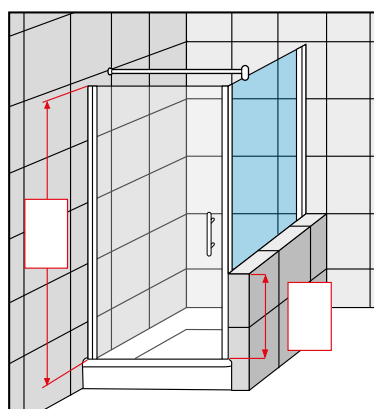

BARRA DE SUJECIÓN A PARED DE 150 CM. INCLUIDA
BARRA DE FIXAÇÃO À PAREDE DE 150 CM. INCLUIDA

PARA MÁS OPCIONES DE PANELES FIJOS ESPECIALES, CONSULTAR LA TARIFA "AREA DE PROYECTOS"
PARA MAIS FIXOS ESPECIAIS, CONSULTAR A TARIFA "AREA DE PROYECTOS"





BARRA ESTABILIZADORA
BARRA ESTABILIZADORA

Color Cores	Medidas	Código	Precio Preço
Blanco mate Branco mate	25 cm	R80LOU250-U	76 €
Cromo		R80LOU250-K	76 €
Negro mate		R80LOU250-H	76 €
Inox satinado		R80LOU250-Z	92 €
Blanco mate Branco mate	35 cm	R80LOU350-U	83 €
Cromo		R80LOU350-K	83 €
Negro mate		R80LOU350-H	83 €
Inox satinado		R80LOU350-Z	100 €
Blanco mate Branco mate	45 cm	R80LOU450-U	90 €
Cromo		R80LOU450-K	90 €
Negro mate		R80LOU450-H	90 €
Inox satinado		R80LOU450-Z	108 €



BARRA DE SUJECCIÓN 200 CM
BARRA DE SUJECCIÓN 200 CM

Color Cores	Código	Precio Preço
Blanco mate Branco mate	R80Y220-U	73 €
Silver Abrillantado	R80Y220-B	80 €
Cromo	R80Y220-K	87 €
Negro mate	R80Y220-H	87 €
Inox satinado	R80Y220-Z	105 €



KIT BARRA ORIENTABLE (CONTIENE)

- 1 barra de 100 cms
- 1 pieza sujeción a muro / *peça fixação a parede*
- 1 pieza de fijación al cristal / *peça fixação a vidro*

Color Cores	Medidas	Código	Precio Preço
Blanco mate Branco mate	100 cm	R80KUOR100-U	111 €
Silver Abrillantado		R80KUOR100-B	124 €
Cromo		R80KUOR100-K	135 €
Negro mate		R80KUOR100-H	135 €
Inox satinado		R80KUOR100-Z	162 €



KIT BARRA EN "T"

barra de sujeción de 150 cm para unir a la barra suministrada con el fijo

Color Cores	Código	Precio Preço
Blanco mate Branco mate	R80Y215T-U	95 €
Silver Abrillantado	R80Y215T-B	104 €
Cromo	R80Y215T-K	114 €
Negro mate	R80Y215T-H	114 €
Inox satinado	R80Y215T-Z	139 €



JUNTA HORIZONTAL INFERIOR - 100 CM PARA INSTALACIONES SIN KIT ESTANCO
JUNTA HORIZONTAL INFERIOR - 100 CM PARA INSTALAÇÕES SEM KIT ESTANQUE

PER YOUNG 2A - 2B

Código	Precio / Preço
R55SPB02A1-TR	27 €

PER YOUNG A / 2G / 2GS

Código	Precio / Preço
R55SPB0A01-TR	46 €

PER YOUNG 1B - 1BS - 2P - G

Código	Precio / Preço
R55SPBOM01-TR	46 €



JUNTA HORIZONTAL INFERIOR PARA INSTALACIONES SIN KIT ESTANCO
JUNTA HORIZONTAL INFERIOR PARA INSTALAÇÕES SEM KIT ESTANQUE

PER YOUNG R2, R2LUX

Código	Precio / Preço
R55SPBOR01-TR	57 €

PER YOUNG R, R1

Código	Precio / Preço
R55SPBOR11-TR	57 €

DATOS TÉCNICOS / DADOS TÉCNICOS

COLORES PERFILES CORES PERFÍS

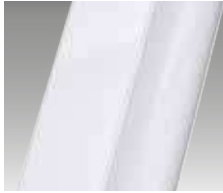

Blanco mate
Branco
cod. U

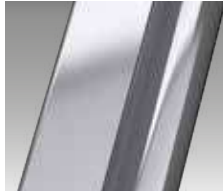

Silver
Abrillantado
cod. B



Cromo
cod. K



Negro mate
cod. H

CRISTAL TEMPLADO VIDRO TEMPERADO 6 mm (Según norma Europea UNE EN 14428)



Transparente
cod. 1



Aqua
cod. 2



Satin
cod. 4

MANIGLIA



Tirador cromado

OPTIONAL



Tirador doble cromado

Color Cores	Código	Precio Preço
Cromo	R40EIMAY21-K	93 €
Negro	R40EIMAY21-H	93 €

MEDIDAS QUE OCUPAN LOS PERFILES EN LA PARED / ESPAÇO QUE OCUPAN OS PERFÍS NA PAREDE

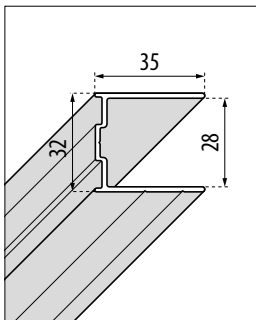

A PARED

Altura	Perfiles/Perfis	Código
1984	Blanco / Branco	P01BNMOBST-U
	Silver / Abrillantado	P01BNMOBST-B
	Cromo	P01BNMOBST-K
	Negro	P01BNMOBST-H
2000	Blanco / Branco	P01BNMOAST-U
	Silver / Abrillantado	P01BNMOAST-B
	Cromo	P01BNMOAST-K
	Negro	P01BNMOAST-H

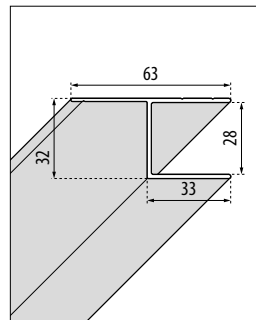

A PARED (OPCIONAL)

Altura	Perfiles/Perfis	Código
1984	Blanco / Branco	P01Y2MOBSTL-U
	Silver / Abrillantado	P01Y2MOBSTL-B
	Cromo	P01Y2MOBSTL-K
	Negro	P01Y2MOBSTL-H
2000	Blanco / Branco	P01Y2MOASTL-U
	Silver / Abrillantado	P01Y2MOASTL-B
	Cromo	P01Y2MOASTL-K
	Negro	P01Y2MOASTL-H

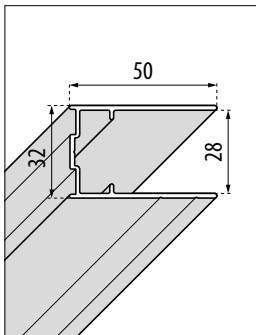

COMPENSADORES

En lugar del perfil pared (+15 mm)
Em lugar do perfil parede (+15 mm)

Altura	Perfiles/Perfis	Código
1984	Blanco / Branco	P05Y2ST-U
	Silver / Abrillantado	P05Y2ST-B
	Cromo	P05Y2ST-K
	Negro	P05Y2ST-H
2000	Blanco / Branco	P05Y2ST2-U
	Silver / Abrillantado	P05Y2ST2-B
	Cromo	P05Y2ST2-K
	Negro	P05Y2ST2-H

TOMA DE MEDIDAS

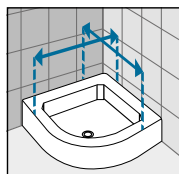
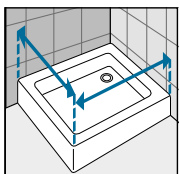

Tomar las medidas desde la pared hasta el borde externo del plato de ducha.

Medir a distância desde a parede até o rebordo externo da base de chuveiro.

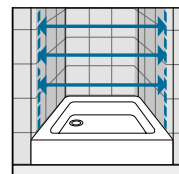

Tomar medidas de pared a pared, medir la parte baja, la central y la superior. Cursar el pedido con la medida más pequeña.

Medir a distância entre paredes, sem que tirar três medidas (inferior, superior e central) e utilizar a inferior. Encomendar pedido da medida mais pequena.



GALA

LA PUREZA DEL CRISTAL.
LA CALIDAD SIN LÍMITES.
A PUREZA DO VIDRO.
A QUALIDADE SEM
LIMITES.



◀ Bisagras regulables de metal cromado



◀ Cristales paralelos
Vidros paralelos



◀ Bisagra y tirador diseñadas por Marco Pellici Studio



TRATAMIENTOS / TRATAMENTOS





GALA

GALA 2P+F



200 cm



8 mm



No reversible
puerta



2,5 cm



Reversible Fijo
Reversível Fixo



PUERTA DE UNA HOJA ABATIBLE Y FIJO + UN FIJO LATERAL

RESGUARDO PARA DUCHE COMPOSTO POR UMA PORTA ABATIVEL + 1 FIXO E PAINEL FIXO LATERAL

Design Marco Pellici

Medidas							Código	Derecha Direita	Izquierda Esquerda	Selección Cristales Seleção Vidros	Selección de perfiles Seleção de perfis
Medidas extensibilidad Medidas extensibilidade	Medidas extensibilidad para platos a ras de suelo	Fijo frontal Fijo frontal	Entrada		Espacio de apertura Espaço de abertura						
			Min	Max	Min	Max					
A	G	F1	*	*	B	B		D-	S-	1	K
										Transparente	Cromo
PUERTA / PORTA											
113,5↔116	112,5↔115	55	51	53	54	57	GALA12PF115	D-	S-		1.412 €
116↔118,5	115↔117,5	58	51	53	54	57	GALA12PF120	D-	S-		1.558 €
136↔138,5	135↔137,5	68	61	63	64	67	GALA12PF140	D-	S-		1.709 €
156↔158,5	155↔157,5	78	71	73	74	77	GALA12PF160	D-	S-		1.857 €
176↔178,5	175↔177,5	88	81	83	84	87	GALA12PF180	D-	S-		2.003 €
H 150↑210 L 113,5↔180					ESPECIAL		GALA12PFSP	-	-		2.223 €
FIJO / FIXO											
F	G										
66↔68,5	65↔67,5	-	-	-	-	-	GALA1F70-	-	-		639 €
71↔73,5	70↔72,5	-	-	-	-	-	GALA1F75-	-	-		671 €
76↔78,5	75↔77,5	-	-	-	-	-	GALA1F80-	-	-		700 €
86↔88,5	85↔87,5	-	-	-	-	-	GALA1F90-	-	-		729 €
96↔98,5	95↔97,5	-	-	-	-	-	GALA1F100-	-	-		760 €
106↔108,5	105↔107,5	-	-	-	-	-	GALA1F110-	-	-		789 €
116↔118,5	115↔117,5	-	-	-	-	-	GALA1F120-	-	-		818 €
H 150↑210 L 26↔121					ESPECIAL		GALA1FSP	-	-		889 €

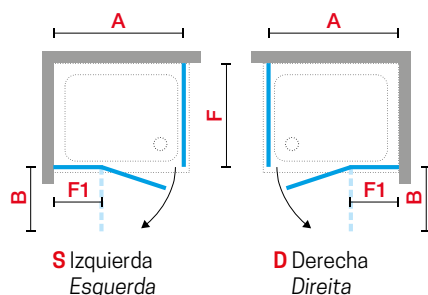
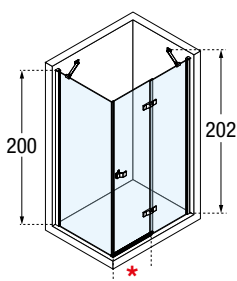

¡IMPORTANTE!
INDICAR EN PEDIDO
SI EL PLATO ES
SOBREELEVADO O A
RAS DE SUELO

INDICAR NA
ENCOMENDA SE
A BASE E SOBRE
ELEVADO O A NIVEL
DO CHÃO

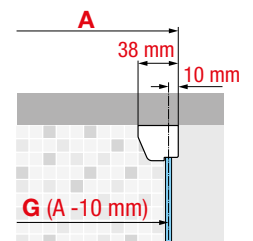



CRISTAL TEMPLADO / VIDRO TEMPERADO

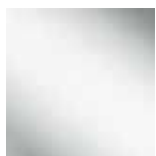

Transparente
cod 1

COLORES PERFILES / CORES PERFÍS



Cromo
cod K

GALA 2P



200 cm



8 mm



2,5 cm



No reversible
Não reversível



PUERTA DE UNA HOJA ABATIBLE + UN FIJO

RESGUARDO PARA DUCHE COMPOSTO POR UMA PORTA ABATIVEL + 1 FIXO

Design Marco Pellici

Medidas						Código	Derecha Direita	Izquierda Esquerda	Selección Cristales Seleção Vidros	Selección de perfiles Seleção de perfis
Medidas extensibilidad Medidas extensibilidade	Fijo frontal Fixo frontal	Entrada		Espacio de apertura Espaço de abertura						
		Min	Max	Min	Max					
A	F1	*	*	B	B		D-	S-	1	K
									Transparente	Cromo
114,5↔117	55	51	53	54	57	GALA12P115	D-	S-		1.486 €
117↔119,5	58	51	53	54	57	GALA12P120	D-	S-		1.632 €
137↔139,5	68	61	63	64	67	GALA12P140	D-	S-		1.781 €
157↔159,5	78	71	73	74	77	GALA12P160	D-	S-		1.929 €
177↔179,5	88	81	83	84	87	GALA12P180	D-	S-		2.078 €
H 150†210 L 114,5↔180				ESPECIAL		GALA12PSP	-	-		2.294 €

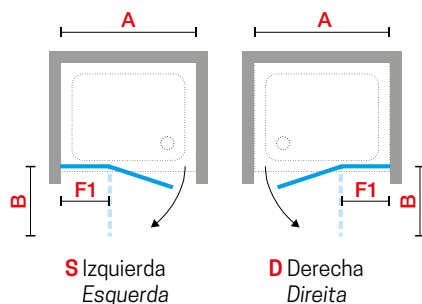
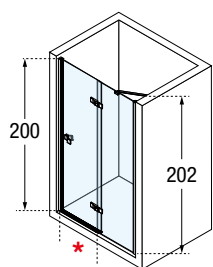



CRISTAL TEMPLADO / VIDRO TEMPERADO



Transparente
cod 1

COLORES PERFILES / CORES PERFÍS



Cromo
cod K

GALA G+F



PUERTA DE UNA HOJA ABATIBLE Y FIJO + UN FIJO LATERAL

RESGUARDO PARA DUCHE COMPOSTO POR UMA PORTA ABATIVEL + 1 FIXO E PAINEL FIXO LATERAL

Design Marco Pellici

Medidas							Código	Derecha Direita	Izquierda Esquerda	Selección Cristales Seleção Vidros	Selección de perfiles Seleção de perfis	
Medidas extensibilidad Medidas extensibilidade	Medidas extensibilidad para platos a ras de suelo	Fijo frontal Fixo frontal	Entrada		Espacio de apertura Espaço de abertura							
A	G	F1	Min	Max	Min	Max	D-	S-	1	K		
			*	*	B	B			Transparente	Cromo		
PUERTA / PORTA												
76↔78,5	75↔77,5	18	51	54	54	57	GALA1G80	D-	S-		1.070 €	
86↔88,5	85↔87,5	18	61	64	64	67	GALA1G90	D-	S-		1.160 €	
96↔98,5	95↔97,5	18	71	74	74	77	GALA1G100	D-	S-		1.249 €	
106↔108,5	105↔107,5	18	81	84	84	87	GALA1G110	D-	S-		1.336 €	
116↔118,5	115↔117,5	28	81	84	84	87	GALA1G120	D-	S-		1.426 €	
H 150†210 L 76↔120							ESPECIAL	GALA1GSP	-	-		2.223 €
FIJO / FIXO												
66↔68,5	65↔67,5	-	-	-	-	-	GALA1F70-	-	-		639 €	
71↔73,5	70↔72,5	-	-	-	-	-	GALA1F75-	-	-		671 €	
76↔78,5	75↔77,5	-	-	-	-	-	GALA1F80-	-	-		700 €	
86↔88,5	85↔87,5	-	-	-	-	-	GALA1F90-	-	-		729 €	
96↔98,5	95↔97,5	-	-	-	-	-	GALA1F100-	-	-		760 €	
106↔108,5	105↔107,5	-	-	-	-	-	GALA1F110-	-	-		789 €	
116↔118,5	115↔117,5	-	-	-	-	-	GALA1F120-	-	-		818 €	
H 150†210 L 26↔121							ESPECIAL	GALA1FSP	-	-		889 €

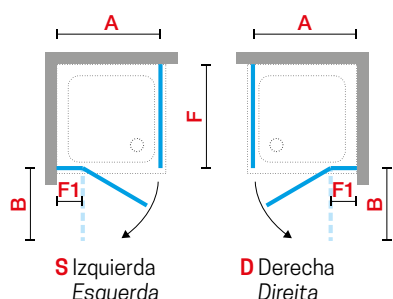
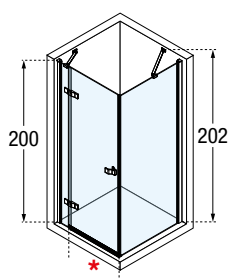

¡IMPORTANTE!
INDICAR EN PEDIDO
SI EL PLATO ES
SOBREELEVADO O A
RAS DE SUELO

INDICAR NA
ENCOMENDA SE
A BASE E SOBRE
ELEVADO O A NIVEL
DO CHÃO

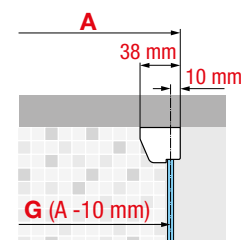



CRISTAL TEMPLADO / VIDRO TEMPERADO



Transparente
cod 1

COLORES PERFILES / CORES PERFÍS



Cromo
cod K

GALA 1B



200 cm



8 mm



2,5 cm



No reversible
Não reversível



PUERTA DE UNA HOJA ABATIBLE + UN FIJO

RESGUADO PARA BASE COMPOSTO POR UNA PORTA ABATIVEL E UM FIXO

Design Marco Pellici

Medidas						Código	Derecha Direita	Izquierda Esquerda	Selección Cristales Seleção Vidros	Selección de perfiles Seleção de perfis
Medidas extensibilidad Medidas extensibilidade	Fijo frontal Fixo frontal	Entrada		Espacio de apertura Espaço de abertura						
		Min	Max	Min	Max	D-	S-	1	K	
A	F1	*	*	B	B				Transparente	Cromo
77↔79,5	18	51	53	54	57	GALA11B80	D-	S-		1.307 €
87↔89,5	18	61	63	64	67	GALA11B90	D-	S-		1.412 €
97↔99,5	18	71	73	74	77	GALA11B100	D-	S-		1.515 €
107↔109,5	18	81	83	84	87	GALA11B110	D-	S-		1.620 €
117↔119,5	28	81	83	84	87	GALA11B120	D-	S-		1.721 €
H 150†210 L 77↔120				ESPECIAL		GALA11BSP				1.836 €

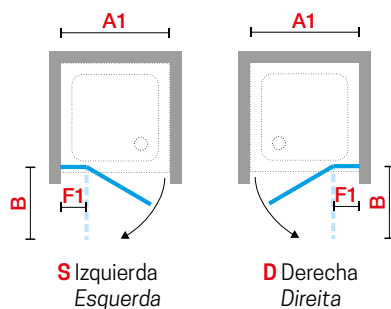
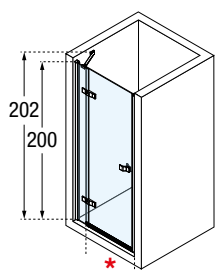



CRISTAL TEMPLADO / VIDRO TEMPERADO

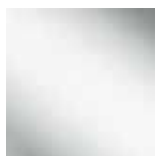

Transparente
cod 1

COLORES PERFILES / CORES PERFÍS



Cromo
cod K

BARRA DE SUJECCIÓN / BARRA DE FIXAÇÃO

BARRA ESTABILIZADORA SUMINISTRADA DE SERIE



OPCIONAL



1

BARRA ORIENTABLE

- 1 barra orientable
- 1 pieza de fijación a pared
- 1 pieza de fijación al cristal

Color Cores	Medidas	Código	Precio Preço
Cromo	100	R80KUOR100-K	135 €
Cromo	150	R80KUOR150-K	140 €
Cromo	180	R80KUOR180-K	143 €



2

KIT ESTABILIZADOR "DOS BARRAS EN T"

- 2 barras de 150 cms ajustables a
- 1 pieza de fijación a pared
- 2 piezas de fijación al cristal
- 1 pieza de unión entre barras

Color Cores	Código	Precio Preço
Cromo	R80KUORT150-K	194 €

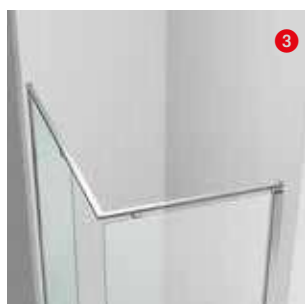

3

NUEVO SISTEMA ESTABILIZADOR EVO (ÁNGULO)

- 1 Barra frontal de 180 cms
- 1 Barra lateral de 120 cms
- 2 Piezas para sujeción a pared
- 1 pieza para la unión angular

Color Cores	Código	Precio Preço
Cromo	KUADHSF-K	283 €



4

NUEVO SISTEMA ESTABILIZADOR EVO (ENTRE PAREDES)

- 1 barra frontal de 180 cms
- 1 pieza para la unión angula

Color Cores	Código	Precio Preço
Cromo	KUADHSFN-K	216 €

EJEMPLOS DE OPCIONES DE BARRAS ESTABILIZADORAS

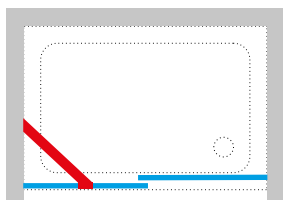

Para esta opción solicitar:

- 1 Barra orientable

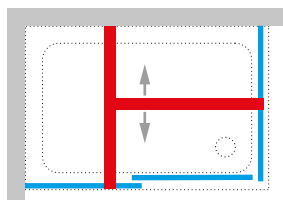

Para esta opción solicitar:

- 2 Kit estabilizador "2 barras en T"

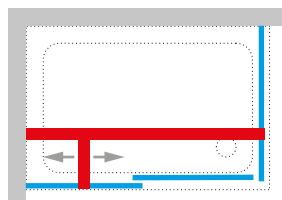

Para esta opción solicitar:

- 2 Kit estabilizador "2 barras en T"

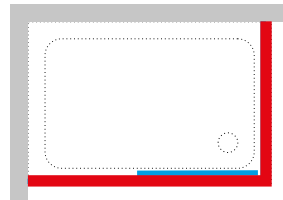

Para esta opción solicitar:

- 3 Nuevo sistema estabilizador EVO (ángulo)

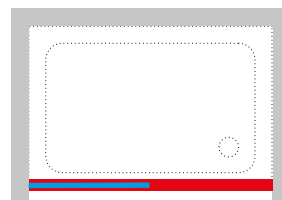

Para esta opción solicitar:

- 4 Nuevo sistema estabilizador EVO (entre paredes)

DATOS TÉCNICOS / DADOS TÉCNICOS

COLORES PERFILES / CORES PERFÍS



Cromo
cod. K



CRISTAL / VIDRO TEMPRATO 8 mm (European standards UNE EN 14428)



Transparente
cod. 1

TIRADOR / PUXADOR



Tirador cromo
Puxador cromo
Distancia entre
agujeros 256 mm Tirador

MEDIDAS QUE OCUPAN LOS PERFILES EN LA PARED / ESPAÇO QUE OCUPAN OS PERFÍS NA PAREDE

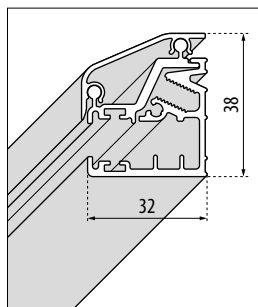

A PARED
para GALA A / G / 1B / 2P / 2A / R

Color/ Cores	Código
Cromo	KP01GA1MO-K

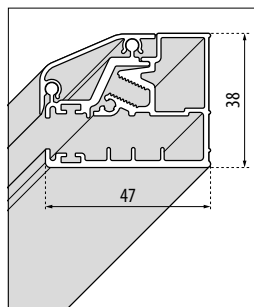

A PARED
para fijo lateral

Color/ Cores	Código
Cromo	KP01GA1FI-K

TOMA DE MEDIDAS

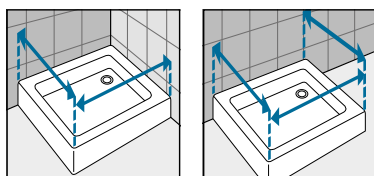

Tomar las medidas desde la pared hasta el borde externo del plato de ducha.
Medir a distância desde a parede até o rebordo externo da base de chuveiro.

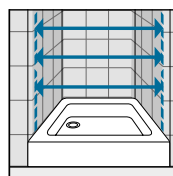

Tomar medidas de pared a pared, medir la parte baja, la central y la superior. Cursar el pedido con la medida más pequeña.
Medir a distância entre paredes, tem que tirar três medidas (inferior, superior e central) e utilizar a inferior. Encomendar pedido da medida mais pequena.

BRERA

TU ESPACIO PREFERIDO
TRADUCIDO A UNA
MAMPARA DE BAÑO.

*SEU ESPAÇO FAVORITO
TRADUZIDO NUM
RESGUARDO DE DUCHE.*



◀ Bisagras regulables de metal cromado, auto-elevable y apertura 180° exterior



◀ Barra de sujeción
Barra de fixação



◀ Bisagra y tirador diseñadas por Marco Pellici Studio



TRATAMIENTOS / TRATAMENTOS





BRERA

MAMPARA DE UNA HOJA ABATIBLE + 1 FIJA ENTRE PAREDES
RESGUARDO ORMADO POR UMA PORTA ABATIVEL E FIXO EM LINHA

Medidas				Código	Derecha Direita	Izquierda Esquerda	Selección Cristales Seleção Vidros			Selección de perfiles Seleção de perfis	
Medidas extensibilidad Medidas extensibilidade	Fijo frontal Fixo frontal	Entrada	Espacio de apertura Espaço de abertura		D-	S-	1	54	79	B	K
A	F1	*	B				Transparente	Fumé gris	Serigrafía Jeans	Silver Abrillantado	Cromo
69↔71	18	46	49	BRERAG70L	D-	S-	+ 106 €	+ 40 €		725 €	798 €
74↔76	23	46	49	BRERAG75L	D-	S-				757 €	832 €
79↔81	28	46	49	BRERAG80L	D-	S-				788 €	867 €
84↔86	33	46	49	BRERAG85L	D-	S-				816 €	899 €
89↔91	23	61	64	BRERAG90L	D-	S-				851 €	937 €
94↔96	28	61	64	BRERAG95L	D-	S-				884 €	973 €
99↔101	33	61	64	BRERAG100L	D-	S-				919 €	1.011 €
109↔111	43	61	64	BRERAG110L	D-	S-				953 €	1.049 €
119↔121	53	61	64	BRERAG120L	D-	S-				988 €	1.085 €
129↔131	53	71	74	BRERAG130L	D-	S-				1.005 €	1.106 €
139↔141	63	71	74	BRERAG140L	D-	S-				1.021 €	1.124 €
149↔151	73	71	74	BRERAG150L	D-	S-				1.070 €	1.176 €
159↔161	83	71	74	BRERAG160L	D-	S-				1.132 €	1.246 €
169↔171	93	71	74	BRERAG170L	D-	S-				1.197 €	1.317 €
H 170†220 L 68↔170			ESPECIAL	BRERAGSP	-	-	-	-		1.350 €	1.486 €

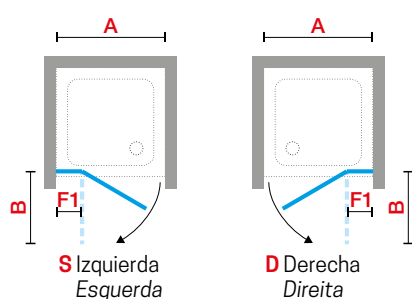
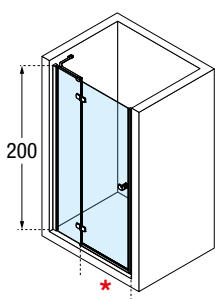



CRISTAL TEMPLADO / VIDRO TEMPERADO



Transparente
cod 1

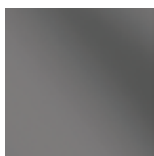

Fumé
Gris
cod 54



Serigrafía
Jeans
cod 79

COLORES PERFILES / CORES PERFÍS

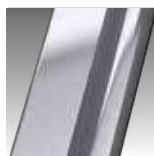

Silver
Abrillantado
cod B



Cromo
cod K

BRERA G+F



200 cm

6 mm

2 cm

No reversible puerta

Reversible Fijo

Reversible Fijo

Reversible Fijo

PUERTA DE UNA HOJA ABATIBLE Y UNA FIJA + UN FIJO LATERAL

RESGUARDO PARA BASE COMPOSTOR POR UMA POR ABATIVEL + 1 FIXO E UM FIXO LATERAL

No reversible puerta
Não reversível porta

Reversible Fijo
Reversible Fijo

Medidas					Código	Derecha Direita	Izquierda Esquerda	Selección Cristales Seleção Vidros			Selección de perfiles Seleção de perfis	
Medidas extensibilidad Medidas extensibilidade	Medidas extensibilidad para platos a ras de suelo	Fijo frontal Fijo frontal	Entrada	Espacio de apertura Espaço de abertura				1	54	79	B	K
A	G	F1	*	B		D-	S-	Transparente	Fumé gris	Serigrafía Jeans	Silver Abrrillantado	Cromo

PUERTA / PORTA

67↔69	66↔68	18	46	49	BRERAGF70L	D-	S-				725 €	798 €
72↔74	71↔73	23	46	49	BRERAGF75L	D-	S-				757 €	832 €
77↔79	76↔78	28	46	49	BRERAGF80L	D-	S-				788 €	867 €
82↔84	81↔83	33	46	49	BRERAGF85L	D-	S-				816 €	899 €
87↔89	86↔88	23	61	64	BRERAGF90L	D-	S-				851 €	937 €
92↔94	91↔93	28	61	64	BRERAGF95L	D-	S-				884 €	973 €
97↔99	96↔98	33	61	64	BRERAGF100L	D-	S-				919 €	1.011 €
107↔109	106↔108	43	61	64	BRERAGF110L	D-	S-		+ 106 €	+ 40 €	953 €	1.049 €
117↔119	116↔118	53	61	64	BRERAGF120L	D-	S-				988 €	1.085 €
127↔129	126↔128	53	71	74	BRERAGF130L	D-	S-				1.005 €	1.106 €
137↔139	136↔138	63	71	74	BRERAGF140L	D-	S-				1.021 €	1.124 €
147↔149	146↔148	73	71	74	BRERAGF150L	D-	S-				1.070 €	1.176 €
157↔159	156↔158	83	71	74	BRERAGF160L	D-	S-				1.132 €	1.246 €
167↔169	166↔168	93	71	74	BRERAGF170L	D-	S-				1.197 €	1.317 €
H 170↔220 L 67↔169			ESPECIAL		BRERAGFSP	-	-		-	-	1.350 €	1.486 €

FIJO PANEL REVERSIBLE / FIXO PAINEL REVERSÍVEL

F	G											
67↔69	66↔68	-	-	-	BRERAF70-						560 €	614 €
72↔74	71↔73	-	-	-	BRERAF75-						591 €	651 €
77↔79	76↔78	-	-	-	BRERAF80-						623 €	686 €
82↔84	81↔83	-	-	-	BRERAF85-						655 €	720 €
87↔89	86↔88	-	-	-	BRERAF90-				+ 106 €	+ 40 €	687 €	755 €
92↔94	91↔93	-	-	-	BRERAF95-						720 €	790 €
97↔99	96↔98	-	-	-	BRERAF100-						752 €	825 €
107↔109	106↔108	-	-	-	BRERAF110-						766 €	843 €
117↔119	116↔118	-	-	-	BRERAF120-						782 €	856 €
H 170↔220 L 20↔119			ESPECIAL		BRERAFSP				+ 106 €	-	825 €	905 €

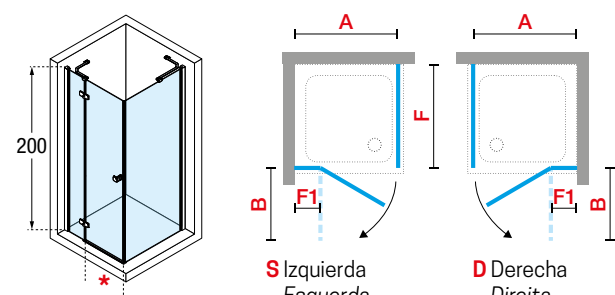

IMPORTANT!
INDICAR EN PEDIDO SI EL PLATO ES SOBREELEVADO O A RAS DE SUELO
INDICAR NA ENCOMENDA SE A BASE E SOBRE ELEVADO O A NIVEL DO CHÃO

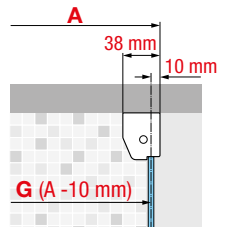



CRISTAL TEMPLADO / VIDRO TEMPERADO



Transparente
cod 1

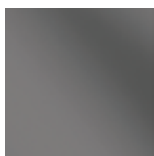

Fumé
Gris
cod 54



Serigrafía
Jeans
cod 79

COLORES PERFILES / CORES PERFÍS

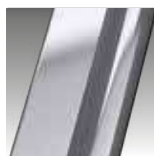

Silver
Abrillantado
cod B



Cromo
cod K

BRERA A



ANGULAR DE DOS PUERTAS ABATIBLES + DOS FIJOS
RESGUARDO PARA DUCHE ANGULAR COMPOSTO POR DUAS PORTAS ABATIVAS E DOIS FIXOS



CRISTAL TEMPLADO VIDRO TEMPERADO



Transparente
cod 1

Fumé
Gris
cod 54



Serigrafia
Jeans
cod 79

COLORES PERFILES CORES PERFÍS

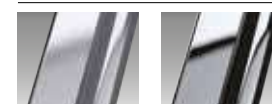

Silver
Abrillantado
cod B

Cromo
cod K

Medidas					Código	Derecha Direita	Izquierda Esquerda	Selección Cristales Seleção Vidros			Selección de perfiles Seleção de perfís	
Medidas extensibilidad Medidas extensibilidade	Medidas extensibilidad para platos a ras de suelo	Fijo frontal Fixo frontal	Entrada	Espacio de apertura Espaço de abertura				D-	S-	1	54	79
A	G	F1	*	B			Transpa- rente	Fumé gris	Serigrafia Jeans	Silver Abrillantado	Cromo	
67↔69	66↔68	18	69	49	BRERAA70L	D-	S-				693 €	762 €
72↔74	71↔73	23	69	49	BRERAA75L	D-	S-				708 €	781 €
77↔79	76↔78	28	69	49	BRERAA80L	D-	S-				724 €	797 €
82↔84	81↔83	33	69	49	BRERAA85L	D-	S-				742 €	816 €
87↔89	86↔88	23	90	64	BRERAA90L	D-	S-		+ 106 €	+ 40 €	757 €	832 €
92↔94	91↔93	28	90	64	BRERAA95L	D-	S-				773 €	851 €
97↔99	96↔98	33	90	64	BRERAA100L	D-	S-				792 €	872 €
107↔109	106↔108	43	90	64	BRERAA110L	D-	S-				824 €	905 €
117↔119	116↔118	53	90	64	BRERAA120L	D-	S-				855 €	941 €
H 170↔220 L 66↔118				ESPECIAL	BRERAALSP				-	-	991 €	1.092 €

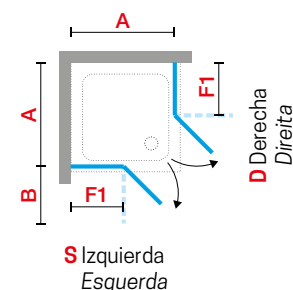
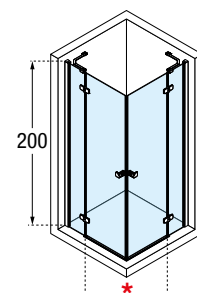

PARA COMPONER UN ÁNGULO PEDIR 2 LATERALES
FORMAR UM ÁNGULO PEDINDO DOIS LATERAIS

¡IMPORTANTE!
INDICAR EN PEDIDO
SI EL PLATO ES
SOBREELEVADO O A
RAS DE SUELO
INDICAR NA
ENCOMENDA SE
A BASE E SOBRE
ELEVADO O A NIVEL
DO CHÃO

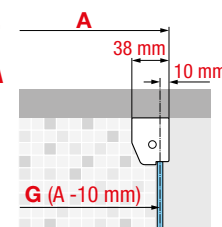

BRERA R



MAMPARA SEMICIRCULAR DE DOS PUERTAS ABATIBLES + DOS FIJOS
RESGUARDO PARA BASE SEMICIRCULAR COMPOSTO POR DUAS PORTAS E DOIS FIXOS



CRISTAL TEMPLADO VIDRO TEMPERADO



Transparente
cod 1

Serigrafía
Jeans
cod 79

COLORES PERFILES CORES PERFIS

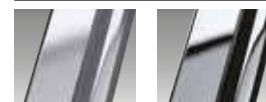

Silver
Abrillantado
cod B

Cromo
cod K

Medidas						Código	Selección Cristales Seleção Vidros		Selección de perfiles Seleção de perfis	
Medidas extensibilidad Medidas extensibilidade	Medidas extensibilidad para platos a ras de suelo	Fijo frontal Fixo frontal	Radio	Entrada	Espacio de apertura Espaço de abertura		1	79	B	K
A	G	F1	R	*	B		Transparente	Serigrafía Jeans	Silver Abrillantado	Cromo
77↔79	76↔78	18	55	82	43	BRERAR80-			1.968 €	2.166 €
87↔89	86↔88	28	55	82	43	BRERAR90-		+ 80 €	2.065 €	2.272 €
97↔99	96↔98	38	55	82	43	BRERAR100-			2.165 €	2.380 €

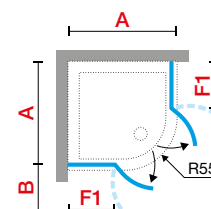
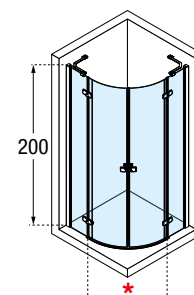

¡IMPORTANTE!
INDICAR EN PEDIDO SI EL PLATO ES SOBREELEVADO O A RAS DE SUELO
INDICAR NA ENCOMENDA SE A BASE E SOBREELEVADO O A NIVEL DO CHÃO

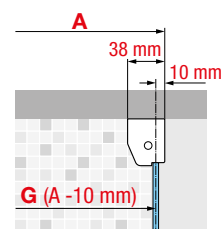

Construcción del código:
Construção do código

Código

+

Cristales
Vidros

+

Perfiles
Perfis

=

Código completo del producto
Código completo do produto

BARRA ESTABILIZADORA / BARRA ESTABILIZADORA

BARRA DE SUJECIÓN STANDARD INCLUIDA BARRA DE FIXAÇÃO STANDARD INCLUIDA



TIRADOR / PUXADOR



Tirador cromo
Puxador cromo

OPCIONAL

1 BARRA ORIENTABLE

1 barra orientable
1 pieza de fijación a pared
1 pieza de fijación al cristal

Color Cores	Medidas	Código	Precio Preço
Cromo	100	R80KUOR100-K	135 €
Cromo	150	R80KUOR150-K	140 €
Cromo	180	R80KUOR180-K	143 €

2 KIT ESTABILIZADOR "DOS BARRAS EN T"

2 barras de 150 cms ajustables a
1 pieza de fijación a pared
2 piezas de fijación al cristal
1 pieza de unión entre barras

Color Cores	Código	Precio Preço
Cromo	R80KUORT150-K	194 €

3 NUEVO SISTEMA ESTABILIZADOR EVO (ÁNGULO)

1 Barra frontal de 180 cms
1 Barra lateral de 120 cms
2 Piezas para sujeción a pared
1 pieza para la unión angular

Color Cores	Código	Precio Preço
Cromo	KUADHSF-K	283 €

4 NUEVO SISTEMA ESTABILIZADOR EVO (ENTRE PAREDES)

1 barra frontal de 180 cms
1 pieza para la unión angula

Color Cores	Código	Precio Preço
Cromo	KUADHSFN-K	216 €

EJEMPLOS DE OPCIONES DE BARRAS ESTABILIZADORAS

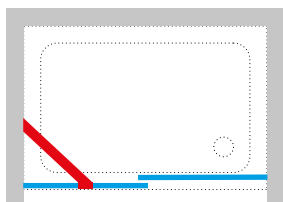

Para esta opción solicitar:

1 Barra orientable

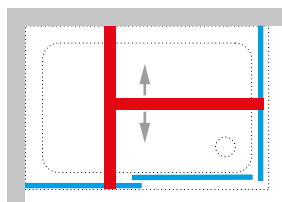

Para esta opción solicitar:

2 Kit estabilizador "2 barras en T"

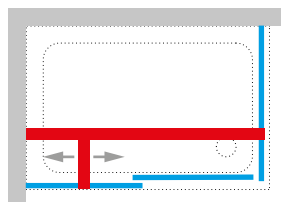

Para esta opción solicitar:

2 Kit estabilizador "2 barras en T"

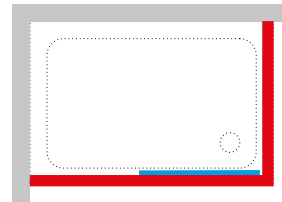

Para esta opción solicitar:

3 Nuevo sistema estabilizador EVO (ángulo)

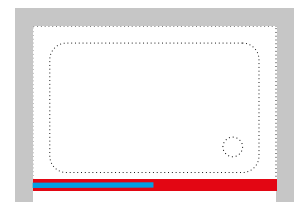

Para esta opción solicitar:

4 Nuevo sistema estabilizador EVO (entre paredes)

DATOS TÉCNICOS / DADOS TÉCNICOS

COLORES PERFILES / CORES PERFÍS

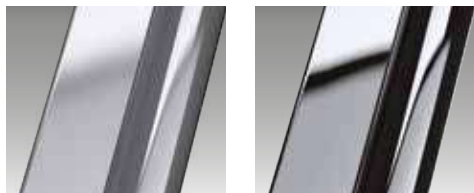

Silver
Abrillantado
cod. B

Cromo
cod. K



CRISTAL TEMPLADO / VIDRO TEMPERADO 6 mm (Según norma Europea UNE EN 14428)



Transparente
cod. 1



Fumé
Gris
cod. 54

SERIGRAFIA



Jeans
cod. 79

MEDIDAS QUE OCUPAN LOS PERFILES EN LA PARED / ESPAÇO QUE OCUPAN OS PERFÍS NA PAREDE FISSAGGIO

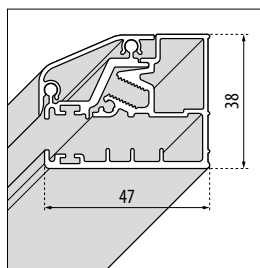

A PARED

para todos los modelos

Color Cores	Código
Cromo	KP01BREMO-K

TOMA DE MEDIDAS

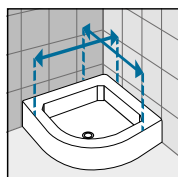
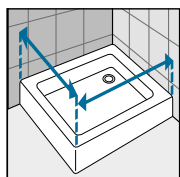

Tomar las medidas desde la pared hasta el borde externo del plato de ducha.

Medir a distância desde a parede até o rebordo externo da base de chuveiro.

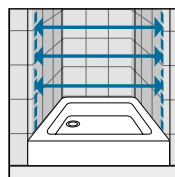

Tomar medidas de pared a pared, medir la parte baja, la central y la superior. Cursar el pedido con la medida más pequeña.

Medir a distância entre paredes, tem que tirar três medidas (inferior, superior e central) e utilizar a inferior. Encomendar pedido da medida mais pequena.

FREE

FUNCIONAL PARA CUALQUIER TIPO DE EXIGENCIA.

FUNCIONAL PARA QUALQUER TIPO DE REQUISITO.



◀ Sistema de apertura de puerta aislando la parte superior (Free 1)
Sistema de abertura separada (Free 1)



◀ La solución para la gran libertad de movimiento
A solução para total liberdade de movimento



◀ Bisagras de metal cromado con sistema de auto-elevación
Dobradiça de metal cromo com sistema de auto elevação



FREE es la serie de mamparas Novellini para lograr la mayor amplitud, soporte y ayuda para satisfacer las exigencias de movilidad reducida sin renunciar al diseño más actual. De simple uso para quien lo utiliza y para quien debe realizar soporte al usuario para el acceso. Además garantiza la movilidad interior maximizando el espacio útil

FREE é a série de resguardos da Novellini para alcançar a maior amplitude, suporte e ajuda para satisfazer as demandas de mobilidade reduzida sem renunciar ao design mais atual. Simples de usar para quem usa e para quem deve suportar o utilizador para o acesso. Também garante a mobilidade interior maximizando o espaço útil.

TRATAMIENTOS / TRATAMENTOS





FREE

FREE 1 2G

MAMPARA ANGULAR DE DOS HOJAS ABATIBLES



195 cm



6 mm



3 cm



CRISTAL TEMPLADO VIDRO TEMPERADO



Transparente
cod 1

COLORES PERFILES CORES PERFÍS



Blanco
Branco
cod. A



Silver
Abrillantado
cod. B



Cromo
cod K

Medidas			Código	Derecha Direita	Izquierda Esquerda	Selección Cristales Seleção Vidros	Selección de perfiles Seleção de perfís		
Medidas extensibilidad Medidas extensibilidade	Entrada	Espacio de apertura Espaço de abertura		D-	S-	1	A	B	K
A	*	B				Transparente	Blanco Branco	Silver Abrillantado	Cromo

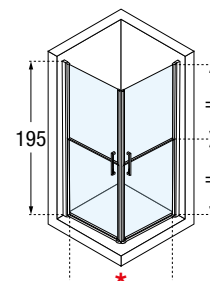

versión simétrica (ángulo completo) / versão simétrica (resguardo inteiro)									
77↔80	95	68	FREE2G80-	-	-		1.601 €	1.796 €	1.976 €
87↔90	110	78	FREE2G90-	-	-		1.681 €	1.883 €	2.073 €
100↔103	128	91	FREE2G100-	-	-		1.830 €	2.050 €	2.256 €
versión asimétrica Free / versão asimétrica Free									
77↔80	-	68	FREE2G80L	D-	S-		800 €	898 €	988 €
87↔90	-	78	FREE2G90L	D-	S-		841 €	941 €	1.037 €
100↔103	-	91	FREE2G100L	D-	S-		915 €	1.025 €	1.128 €
L 76,5↔99,5		ESPECIAL	FREEGSP	-	-		1.042 €	1.168 €	1.286 €

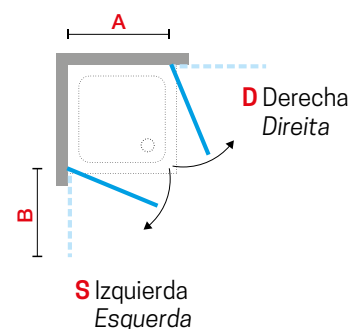

**PARA COMPONER UN ÁNGULO PEDIR 2 LATERALES
FORMAR UM ÁNGULO PEDINDO DOIS LATERAIS**

FREE 1 G+F EN LÍNEA/EM LINHA



195 cm



6 mm



6 cm
puerta
porta



3 cm
fijo
fixo



No reversible
puerta
Não reversível
porta



MAMPARA DE UNA HOJA ABATIBLE + UN FIJO EN LINEA
RESGUARDO DE UMA FOLHA ABATÍVEL + UM FIXO EM LINHA



CRISTAL TEMPLADO VIDRO TEMPERADO



Transparente
cod 1

COLORES PERFILES CORES PERFIS



Blanco
Branco
cod. A



Silver
Abrillantado
cod. B



Cromo
cod K

Medidas					Código	Derecha Direita	Izquierda Esquerda	Selección Cristales Seleção Vidros	Selección de perfiles Seleção de perfis		
Medidas extensibilidad Medidas extensibilidade	Entrada	Espacio de apertura Espaço de abertura		A					B	K	
con fijo com fijo	Entre paredes					D-	S-	1	A	B	K
A1	A	F1	*	B				Transpa- rente	Blanco Branco	Silver Abrillantado	Cromo

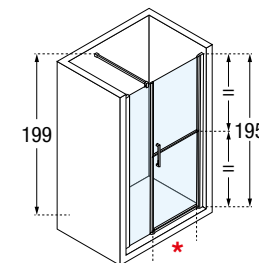

frontal compuesto por puerta + fijo en linea

112,5↔118,5	110↔116	35	67	68	FREEGF110	D-	S-		1.205 €	1.339 €	1.472 €
118,5↔124,5	116↔122	18	90	91	FREEGF120	D-	S-		1.279 €	1.423 €	1.566 €
138,5↔144,5	136↔142	38	90	91	FREEGF140	D-	S-		1.433 €	1.592 €	1.751 €
168,5↔174,5	166↔172	68	90	91	FREEGF170	D-	S-		1.600 €	1.776 €	1.955 €

panel fijo lateral opcional

F					Código	Derecha Direita	Izquierda Esquerda	Selección Cristales Seleção Vidros	Perfiles Perfis		
									A	B	K
77↔80	-	-	-	-	FREEGF80-				703 €	779 €	858 €
87↔90	-	-	-	-	FREEGF90-				747 €	831 €	915 €
104↔107	-	-	-	-	FREEGF100-				794 €	882 €	970 €
124↔127	-	-	-	-	FREEGF120-				841 €	933 €	1.026 €
L 40↔125			ESPECIAL		FREEGFSP	-	-		941 €	1.044 €	1.150 €

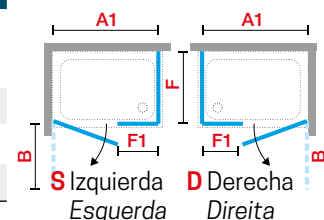
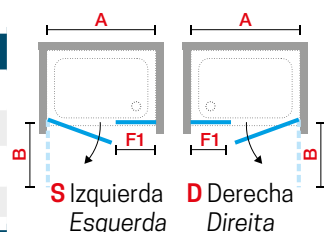

Construcción del código:
Construção do código

Código

+ Izquierda / Derecha
Esquerda / Direita

+ Cristales
Vidros

+ Perfiles
Perfis

= Código completo del producto
Código completo do produto

FREE 1 G+F



195 cm



6 mm



3 cm fijo /
fixo



3 cm puerta /
porta



MAMPARA ANGULAR COMPUESTA POR UNA PUERTA ABATIBLE DIVIDIDA EN DOS PARTES (SUPERIOR E INFERIOR) Y UN FIJO LATERAL

RESGUARDO DE UMA PORTA ABATIVEL DE ABERTURA TOTAL OU A MEIA ALTURA E UM FIXO LATERAL



CRISTAL TEMPLADO VIDRO TEMPERADO



Transparente
cod 1

COLORES PERFILES CORES PERFÍS



Blanco
Branco
cod. A



Silver
Abrillantado
cod. B



Cromo
cod K

Medidas			Código	Derecha Direita	Izquierda Esquerda	Selección Cristales Seleção Vidros	Selección de perfiles Seleção de perfis		
Medidas extensibilidad Medidas extensibilidade	Entrada	Espacio de apertura Espaço de abertura					D-	S-	1
A	*	B				Transparente	Blanco Branco	Silver Abrillantado	Cromo

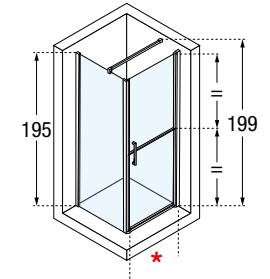

Puerta / Porta									
77↔80	67	68	FREE2G80L	D-	S-		800 €	898 €	988 €
87↔90	77	78	FREE2G90L	D-	S-		841 €	941 €	1.037 €
100↔103	90	91	FREE2G100L	D-	S-		915 €	1.025 €	1.128 €
L 76,5↔99,5		ESPECIAL	FREEGSP	-	-		1.042 €	1.168 €	1.286 €

fijo panel / fixo painel									
F									
78↔81	-	-	FREEF2G80	D-	S-		703 €	788 €	867 €
88↔91	-	-	FREEF2G90	D-	S-		747 €	840 €	924 €
104↔107	-	-	FREEF2G100	D-	S-		794 €	889 €	979 €
L 60,5↔103,5		ESPECIAL	FREEF2GSP	-	-		941 €	1.055 €	1.161 €

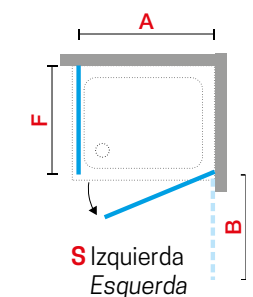
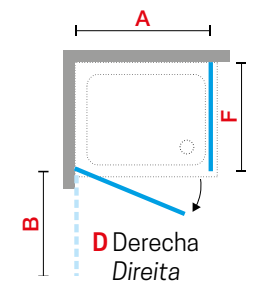

FREE 1 1B



195 cm



6 mm



6 cm



3 cm
fijo/fixo



MAMPARA DE UNA PUERTA ABATIBLE DE APERTURA COMPLETA O A MEDIA ALTURA
RESGUARDO DE UMA PORTA ABATIVEL DE ABERTURA TOTAL OU A MEIA ALTURA



CRISTAL TEMPLADO VIDRO TEMPERADO



Transparente
cod 1

COLORES PERFILES CORES PERFIS



Blanco
Branco
cod. A



Silver
Abrilantado
cod. B



Cromo
cod K

Medidas				Código	Selección Cristales Seleção Vidros	Selección de perfiles Seleção de perfis		
Medidas extensibilidad Medidas extensibilidade		Entrada	Espacio de apertura Espaço de abertura		1	A	B	K
con fijo com fixo	Entre paredes							
A	A1	*	B		Transparente	Blanco Branco	Silver Abrilantado	Cromo

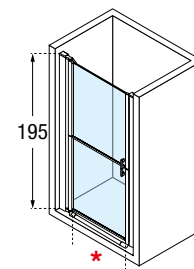

Puerta / Porta								
78,5↔84,5	76↔82	63	64	FREE1B80-		1.007 €	1.128 €	1.240 €
88,5↔94,5	86↔92	73	74	FREE1B90-		1.052 €	1.179 €	1.296 €
106↔112	104↔110	91	92	FREE1B100-		1.097 €	1.230 €	1.354 €

fijo panel / fixo painel								
F								
77↔80	-	-	-	FREEFGF80-		703 €	779 €	858 €
87↔90	-	-	-	FREEFGF90-		747 €	831 €	915 €
104↔107	-	-	-	FREEFGF100-		794 €	882 €	970 €
124↔127	-	-	-	FREEFGF120-		841 €	933 €	1.026 €
L 40↔125			ESPECIAL	FREEFGFSP		941 €	1.044 €	1.150 €

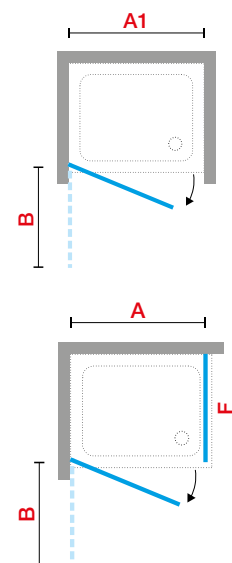

Construcción del código: **Código** + **Cristales Vidros** + **Perfiles Perfis** = Código completo del producto
Construção do código: **Código** + **Cristales Vidros** + **Perfiles Perfis** = Código completo do produto

FREE 1 2B

MAMPARA DE DOS HOJAS ABATIBLES
RESGUARDO DE DUAS FOLHAS ABATIVELIS



195 cm



6 mm



6 cm
puerta/
porta



3 cm
fijo / fixo



CRISTAL TEMPLADO VIDRO TEMPERADO



Transparente
cod 1

COLORES PERFILES CORES PERFÍS



Blanco
Branco
cod. A



Silver
Abrillantado
cod. B



Cromo
cod K

Medidas				Código	Selección Cristales Seleção Vidros	Selección de perfiles Seleção de perfis		
Medidas extensibilidad Medidas extensibilidade		Entrada	Espacio de apertura Espaço de abertura		1	A	B	K
con fijo com fixo	Entre paredes							
A	*		B		Transparente	Blanco Branco	Silver Abrillantado	Cromo

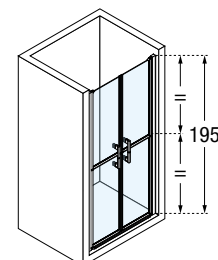

Puerta / Porta							
78,5↔84,5	76↔82	61	30	FREE2B80-	1.265 €	1.415 €	1.557 €
88,5↔94,5	86↔92	71	35	FREE2B90-	1.343 €	1.503 €	1.654 €
98,5↔104,5	96↔102	81	40	FREE2B100-	1.415 €	1.587 €	1.746 €
118,5↔124,5	116↔122	101	50	FREE2B120-	1.494 €	1.674 €	1.842 €

panel fijo lateral opcional							
F							
77,5↔80,5	-	-	-	FREEF2B80-	703 €	779 €	858 €
87,5↔90,5	-	-	-	FREEF2B90-	747 €	831 €	915 €
104↔107	-	-	-	FREEF2B100-	794 €	882 €	970 €
124↔127	-	-	-	FREEF2B120-	841 €	933 €	1.026 €

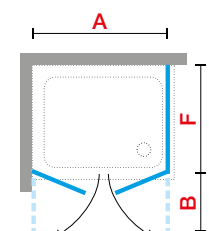
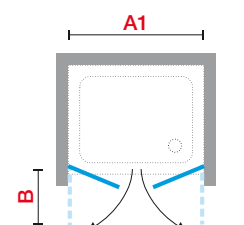

FREE 1 A



195 cm



6 mm



3 cm



MAMPARA ANGULAR DE DOS HOJAS ABATIBLES
RESGUARDO ANGULAR DE DUAS FOLHAS ABATÍVELS



CRISTAL TEMPLADO VIDRO TEMPERADO



Transparente
cod 1

COLORES PERFILES CORES PERFIS



Blanco
Branco
cod. A



Silver
Abrillantado
cod. B



Cromo
cod K

Medidas				Código	Selección Cristales Seleção Vidros	Selección de perfiles Seleção de perfis		
Medidas extensibilidad Medidas extensibilidade	Fijo frontal Fixo frontal	Entrada	Espacio de apertura Espaço de abertura			1	A	B
A	F1	*	B		Transparente	Blanco Branco	Silver Abrillantado	Cromo
versión simétrica (ángulo completo) / versão simétrica (resguardo inteiro)								
124↔127	29	127	92	FREEA120-		1.982 €	2.222 €	2.444 €
154↔157	59	127	92	FREEA150-		2.135 €	2.389 €	2.629 €
versión asimétrica (por lateral) / versão assimétrica (por lateral)								
124↔127	29	-	92	FREEA120L-		991 €	1.111 €	1.222 €
154↔157	59	-	92	FREEA150L-		1.067 €	1.195 €	1.314 €

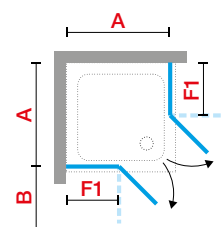
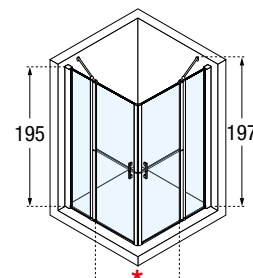

VERSION ASIMÉTRICA PARA COMPONER UN ÁNGULO PEDIR 2 LATERALES
VERSION ASSIMÉTRICA PARA FORMAR UN ÁNGULO PEDIR DOIS LATERAIS

Construcción del código:
Construção do código

Código

+

Cristales
Vidros

+

Perfiles
Perfis

=

Código completo del producto
Código completo do produto

FREE 2 A VERSIÓN ALTA / VERSÃO ALTA



190 cm



3 mm



3 cm



MAMPARA ANGULAR VERSIÓN ALTA
RESGUARDO ANGULAR VERSÃO ALTA



CRISTAL TEMPLADO VIDRO TEMPERADO



Transparente
cod 1



Niva
cod 11



Circular
cod 43

COLORES PERFILES CORES PERFÍS



Blanco
Branco
cod. A



Silver
Abrillantado
cod. B

Medidas		Espacio de apertura Espaço de abertura	Código	Selección Cristales Seleção Vidros		Selección de perfiles Seleção de perfis		Acrylic 43	Selección de perfiles Seleção de perfis	
Medidas extensibilidad Medidas extensibilidade				1	11	A	B		A	B
A	B	B1		Transparente	Niva	Blanco Branco	Silver Abrillantado	circular	Blanco Branco	Silver Abrillantado
64,5↔67,5	59	30	FREE2A66AL-			423 €	479 €		369 €	422 €
67,5↔70,5	62	32	FREE2A69AL-			431 €	488 €		375 €	428 €
70,5↔73,5	65	33	FREE2A72AL-			438 €	495 €		384 €	437 €
73,5↔76,5	68	35	FREE2A75AL-			448 €	507 €		390 €	445 €
76,5↔79,5	71	36	FREE2A78AL-		+ 40 €	458 €	517 €		400 €	456 €
79,5↔82,5	74	38	FREE2A81AL-			464 €	525 €		405 €	461 €
82,5↔85,5	77	39	FREE2A84AL-			464 €	525 €		405 €	461 €
85,5↔88,5	80	41	FREE2A87AL-			472 €	534 €		412 €	471 €
H 85↔190 L 59,5↔98	ESPECIAL		FREE2AALSP		+ 40 €	537 €	608 €		469 €	533 €

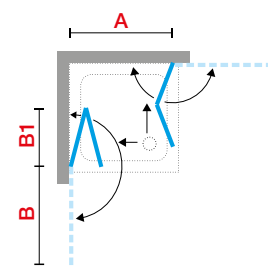
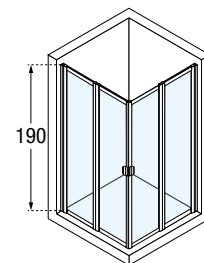

OPCIONAL

PERFIL ESTANCO INFERIOR / PERFIS ESTANCO INFERIOR

Color/Cores	Código	Precio / Preço
Blanco/Branco	R55FR2A-A	87 €
Silver/Abrillantado	R55FR2A-B	87 €
Cromo	R55FR2A-K	97 €

PARA COMPONER UN ÁNGULO PEDIR 2 LATERALES
FORMAR UM ÁNGULO PEDINDO DOIS LATERAIS

FREE 2 A VERSIÓN BAJA / VERSÃO BAIXA



MAMPARA ANGULAR VERSIÓN BAJA RESGUARDO ANGULAR VERSÃO BAIXA



CRISTAL TEMPLADO VIDRO TEMPERADO



Transparente
cod 1



Niva
cod 11



Circular
cod 43

COLORES PERFILES CORES PERFIS



Blanco
Branco
cod. A



Silver
Abrillantado
cod. B

Medidas			Código	Selección Cristales Seleção Vidros		Selección de perfiles Seleção de perfis		Acrílico 43	Selección de perfiles Seleção de perfis	
Medidas extensibilidad Medidas extensibilidade	Espacio de apertura Espaço de abertura			1	11	A	B		A	B
A	B	B1		Transparente	Niva	Blanco Branco	Silver Abrillantado	circular	Blanco Branco	Silver Abrillantado
64,5↔67,5	59	30	FREE2A66BL-			366 €	413 €		333 €	379 €
67,5↔70,5	62	32	FREE2A69BL-			373 €	423 €		341 €	389 €
70,5↔73,5	65	33	FREE2A72BL-			381 €	431 €		348 €	398 €
73,5↔76,5	68	35	FREE2A75BL-			390 €	442 €		357 €	407 €
76,5↔79,5	71	36	FREE2A78BL-			398 €	451 €		363 €	413 €
79,5↔82,5	74	38	FREE2A81BL-			407 €	461 €		371 €	424 €
82,5↔85,5	77	39	FREE2A84BL-			407 €	461 €		371 €	424 €
85,5↔88,5	80	41	FREE2A87BL-			416 €	469 €		378 €	432 €
H 85↔190 L 59,5↔98	ESPECIAL		FREE2AALSP		+ 40 €	537 €	608 €		469 €	533 €

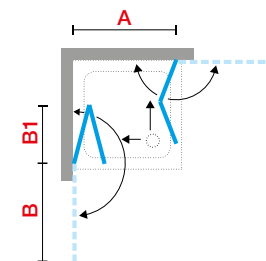
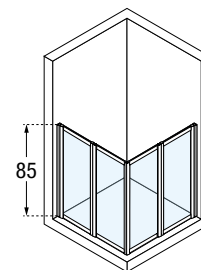

OPCIONAL

PERFIL ESTANCO INFERIOR / PERFIS ESTANCO INFERIOR		
Color/Cores	Código	Precio / Preço
Blanco/Branco	R55FR2A-A	87 €
Silver/Abrillantado	R55FR2A-B	87 €
Cromo	R55FR2A-K	97 €

PARA COMPONER UN ÁNGULO PEDIR 2 LATERALES FORMAR UM ÂNGULO PEDINDO DOIS LATERAIS

Construcción del código: **Código** + **Cristales Vidros** + **Perfiles Perfis** = Código completo del producto
 Construção do código

FREE 2 P VERSIÓN ALTA / VERSÃO ALTA



190 cm



3 mm



6 cm



PUERTA PLEGABLE ENTRE PAREDES

PORTA DE DUAS FOLHAS

Versión alta / Versão alta 190 cm



CRISTAL TEMPLADO VIDRO TEMPERADO



Transparente
cod 1



Niva
cod 11



Circular
cod 43

COLORES PERFILES CORES PERFIS



Blanco
Branco
cod. A



Silver
Abrillantado
cod. B

Medidas		Entrada		Código	Selección Cristales Seleção Vidros		Selección de perfiles Seleção de perfis		Acilico	Selección de perfiles Seleção de perfis	
Medidas extensibilidad Medidas extensibilidade	Espacio de apertura Espaço de abertura				1	11	A	B		43	A
A	B	B1	*		Transpa- rente	Niva	Blanco Branco	Silver Abrillantado	circular	Blanco Branco	Silver Abrillantado
66↔72	54	27	50	FREE2P66A-			464 €	525 €		408 €	471 €
72↔78	60	30	56	FREE2P72A-			480 €	543 €		423 €	487 €
78↔84	66	33	62	FREE2P78A-			495 €	561 €		437 €	504 €
84↔90	72	36	68	FREE2P84A-			514 €	581 €		454 €	522 €
							+ 40 €				

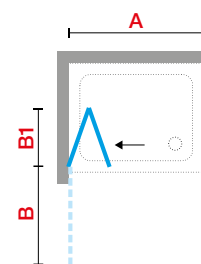
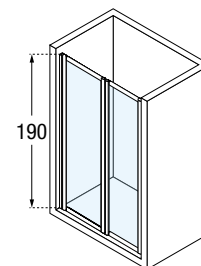

OPCIONAL

PERFIL ESTANCO INFERIOR / PERFIS ESTANCO INFERIOR

Color/Cores	Código	Precio / Preço
Blanco/Branco	R55FR2P-A	87 €
Silver/Abrillantado	R55FR2P-B	87 €
Cromo	R55FR2P-K	97 €



FREE 2 U VERSIÓN ALTA / VERSÃO ALTA



190 cm



3 mm



3 cm



FREE

MAMPARA ANGULAR RESGUARDO ANGULAR

Versión alta / Versão alta 190 cm



CRISTAL TEMPLADO VIDRO TEMPERADO



Transparente
cod 1



Niva
cod 11



Circular
cod 43

COLORES PERFILES CORES PERFIS



Blanco
Branco
cod. A



Silver
Abrillantado
cod. B

Medidas				Código	Selección Cristales Seleção Vidros		Selección de perfiles Seleção de perfis		Acrylic 43	Selección de perfiles Seleção de perfis	
Medidas extensibilidad Medidas extensibilidade	Espacio de apertura Espaço de abertura				1	11	A	B		A	B
C	A	B	B1		Transpa- rente	Niva	Blanco Branco	Silver Abrillantado	circular	Blanco Branco	Silver Abrillantado
65↔68	66	66↔69	33	FREE2U68A-			1.105 €	1.205 €		1.017 €	1.120 €
68↔71	69	69↔72	34,5	FREE2U71A-			1.105 €	1.205 €		1.017 €	1.120 €
70↔73	71	71↔74	35,5	FREE2U73A-			1.123 €	1.223 €		1.034 €	1.136 €
73↔76	74	74↔77	37	FREE2U76A-			1.123 €	1.223 €		1.034 €	1.136 €
75↔78	76	76↔79	38	FREE2U78A-		+ 40 €	1.136 €	1.239 €		1.046 €	1.152 €
78↔81	79	79↔82	39,5	FREE2U81A-			1.136 €	1.239 €		1.046 €	1.152 €
81↔84	82	82↔85	41	FREE2U84A-			1.153 €	1.256 €		1.062 €	1.166 €
85↔88	86	86↔89	43	FREE2U88A-			1.153 €	1.256 €		1.062 €	1.166 €
H 85↔190 L 64↔88		ESPECIAL	FREE2UALSP		+ 40 €		551 €	602 €		518 €	566 €

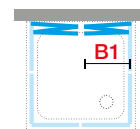
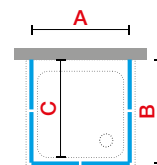
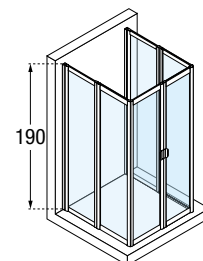

OPCIONAL

PERFIL ESTANCO INFERIOR / PERFIS ESTANCO INFERIOR

Color/Cores	Código	Precio / Preço
Blanco/Branco	R55FR2U-A	87 €
Silver/Abrillantado	R55FR2U-B	87 €
Cromo	R55FR2U-K	97 €

PARA COMPONER UN ÁNGULO PEDIR 2 LATERALES FORMAR UM ÂNGULO PEDINDO DOIS LATERAIS

Construcción del código: **Código** + **Cristales Vidros** + **Perfiles Perfis** = Código completo del producto
 Construção do código

DATOS TÉCNICOS / DADOS TÉCNICOS

COLORES PERFILES / CORES PERFÍS

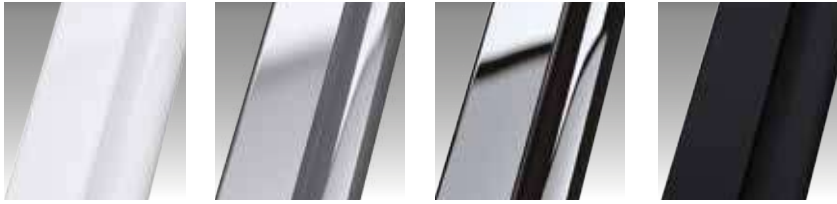

Blanco
Branco
cod. A/D

Silver
Abrillantado
cod. B

Cromo
cod. K



Negro mate
cod. H
(sólo para / só
para: Free 3)

TIRADOR / PUXADOR

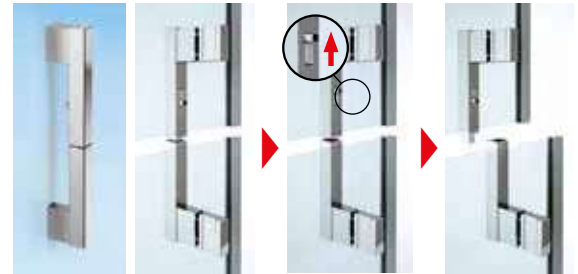

Tirador cromo / Puxador cromo
(sólo para / só para: Free 1)

CRISTAL TEMPLADO / VIDRO TEMPERADO 6 mm (Según norma Europea UNE EN 14428)



Transparente
cod. 1
Free 1 = 6 mm
Free 2 = 3 mm



Niva
cod. 11
(sólo para / só para: Free 2)

ACRÍLICO 3 mm



Circular
cod. 43
(sólo para / só para: Free 2)

MEDIDAS QUE OCUPAN LOS PERFILES EN LA PARED / ESPAÇO QUE OCUPAN OS PERFÍS NA PAREDE - FREE 1 E FREE 2

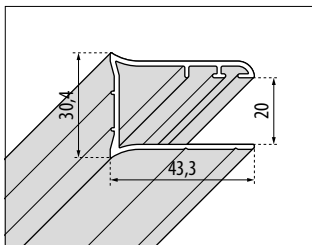

A PARED - FREE 1

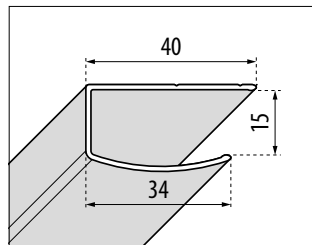

A PARED - FREE 2

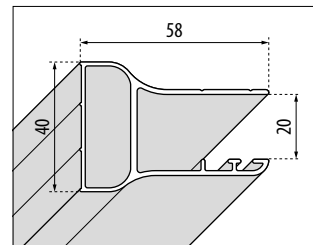

COMPENSADORES - FREE 1

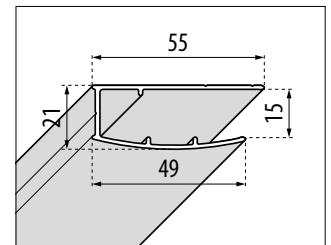

COMPENSADORES - FREE 2

Código

P01FRDMOST-A (h 1939)

P01FRDMOST-B (h 1939)

P01FRDMOST-K (h 1939)

P01YOU02

Código

P01HAAS-T-A (h 1900)

P01HAAS-T-B (h 1900)

P01HAA01

P01FR2POAST-A (h 1890)

P01FR2POAST-B (h 1890)

P01FR2POBST-A (h 840)

P01FR2POBST-B (h 840)

Código

P04DIAS-T-A (h 1950)

P04DIAS-T-B (h 1950)

P04DIA01

Código

P01SACST-A (h 1900)

P01SACST-B (h 1900)

P01SAC01

TOMA DE MEDIDAS

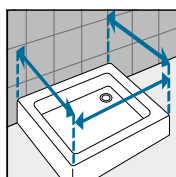
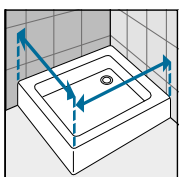

FREE 2

Tomar las medidas desde la pared hasta el borde externo del plato de ducha.
Medir a distância desde a parede até o rebordo externo da base de chuveiro.

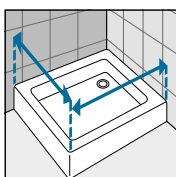

FREE 1

Tomar las medidas desde la pared hasta el borde externo del plato de ducha.
Medir a distância desde a parede até o rebordo externo da base de chuveiro.

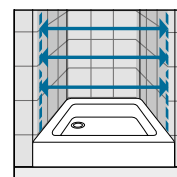

FREE 1-2

Tomar medidas de pared a pared, medir la parte baja, la entral y la superior. Cursar el pedido con la medida más pequeña.
Medir a distância entre paredes, tem que tirar três medidas (inferior, superior e central) e utilizar a inferior. Encomendar pedido da medida mais pequena.



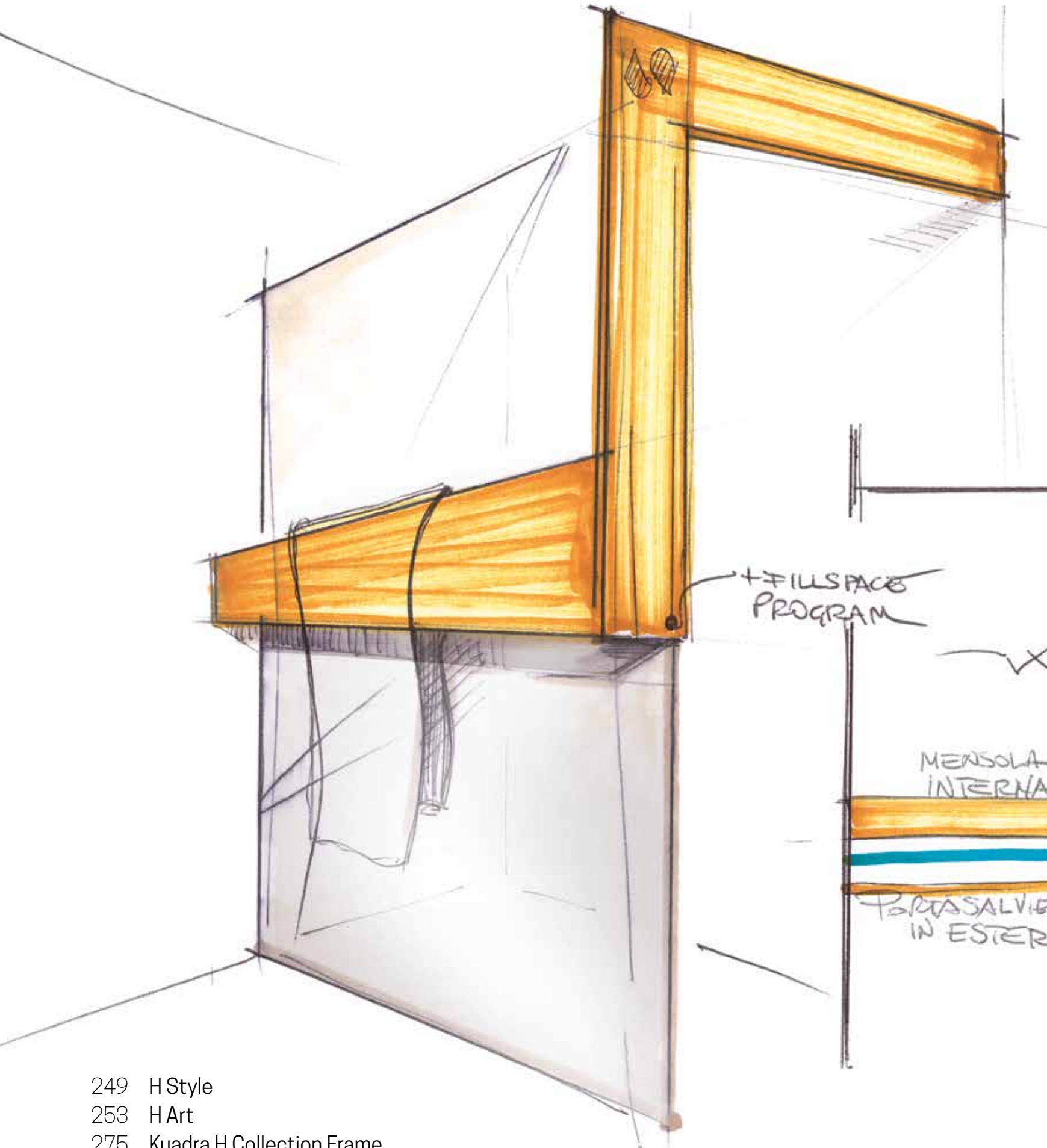

- 249 H Style
- 253 H Art
- 275 Kuadra H Collection Frame
- 290 Kuadra H In Art
- 297 Giada H Collection Edge



ESPACIOS ABIERTOS *ESPAÇOS* ABERTOS

LA CALIDAD Y LA
ELEGANCIA QUE
ENAMORAN A
PRIMERA VISTA.
*QUALIDADE E
ELEGÂNCIA EM
UM OLHO ÚNICO.*

Diferentes diseños que te acompañan en tu estilo personal. Los espacios de ducha abiertos de Novellini dan respuesta a los cambios en las tendencias estéticas. Estudiados y pensados para romper esquemas clásicos y dar vida propia al espacio de ducha sin renunciar a la funcionalidad. La amplia serie de elementos son configurables y combinables con diferentes soluciones técnicas de acceso y nuevos elementos que impactan por su imagen.

O design é transformado para seguir seu estilo. Os resguardos Novellini são inseridos com elegância nos banheiros mais modernos e atraentes, projetados para aqueles que querem quebrar o esquema clássico e dar vida ao seu projeto sem sacrificar a funcionalidade. A ampla gama de elementos pode ser configurada conforme desejado para combinações walk-in essenciais e elegantes, com um impacto visual único.



H STYLE

FLEXIBILIDAD DEL ESPACIO
EN EL CUARTO DE BAÑO
*FLEXIBILIDADE DE ESPAÇO
NA CASA DE BANHO*



◀ Apertura de puerta sobre
guía superior
*Abertura da porta sobre a
guia superior*



◀ Sistema de liberación de
puerta
*Sistema de desbloqueio da
porta*



◀ Carril escondido + freno
puerta
*Carrinho escondido + freio
porta*



H STYLE es sinónimo de arquitectura flexible, un estilo esencial que conecta espacios con continuidad. Fácil de instalar, reduce el desorden gracias a la pared deslizante sobre guías con ruedas totalmente ocultas, equipadas con rodamientos de bolas para un movimiento preciso y silencioso. El desbloqueo de la hoja permite una fácil limpieza, mientras que el sistema de tope de la puerta corredera en línea aumenta la seguridad del movimiento. Ideal para instalaciones, hoteles y soluciones residenciales, elimina las barreras arquitectónicas facilitando el uso del espacio de ducha.

H STYLE representa uma arquitetura flexível, um estilo essencial que liga os espaços com continuidade. Fácil de instalar, reduz a confusão graças à parede deslizante em pistas com rodas totalmente escondidas, equipadas com rolamentos de esferas para um movimento preciso e silencioso. O desprendimento da folha da porta permite uma limpeza fácil, enquanto que o sistema de batente de porta deslizante em linha aumenta a segurança do movimento. Ideal para instalações, hotéis e soluções residenciais, elimina barreiras arquitetónicas ao facilitar a utilização do espaço do chuveiro.

TRATAMIENTOS / TRATAMENTOS





H STYLE

H STYLE

H STYLE

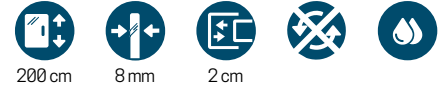

PANEL FIJO SEPARADOR CON PUERTA CORREDERA PAINEL FIXO SEPARADOR COM PORTA DE CORRER

Medidas		Código	Derecha <i>Direita</i>	Izquierda <i>Esquerda</i>	Selección Cristales <i>Seleção</i> Vidros	Selección de perfiles <i>Seleção de perfis</i>			
Medidas extensibilidad <i>Medidas</i> <i>extensibilidade</i>			D-	S-	1	U	B	K	H
A	F				Transparente	Blanco mate <i>Branco mate</i>	Silver <i>Abrillantado</i>	Cromo	Negro mate
97↔99	51	HSTYLE100	D-	S-		1.108 €	1.219 €	1.341 €	1.341 €
117↔119	61	HSTYLE120	D-	S-		1.166 €	1.283 €	1.411 €	1.411 €
137↔139	71	HSTYLE140	D-	S-		1.224 €	1.347 €	1.483 €	1.483 €
157↔159	81	HSTYLE160	D-	S-		1.283 €	1.411 €	1.553 €	1.553 €
177↔179	91	HSTYLE180	D-	S-		1.341 €	1.476 €	1.624 €	1.624 €

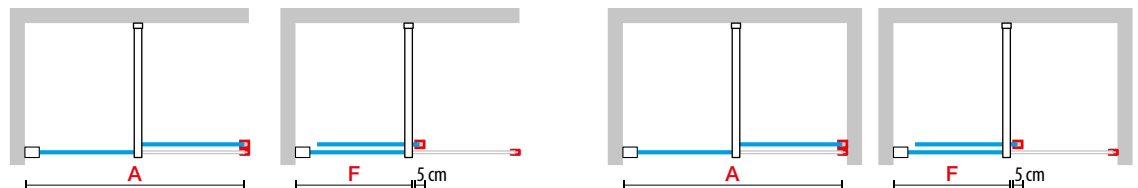
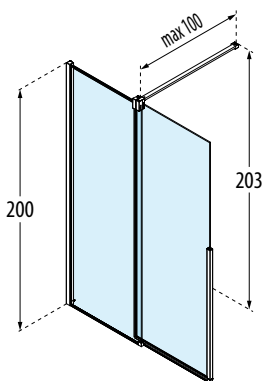



CRISTAL TEMPLADO / VIDRO TEMPERADO



Transparente
cod. 1

COLORES PERFILES / CORES PERFÍS



Blanco mate
Branco mate
cod. U

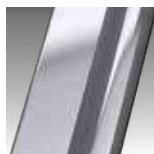

Silver
Abrillantado
cod. B



Cromo
cod. K



Negro mate
cod. H

H ART

ARTESANÍA
EN EL ESPACIO DE DUCHA
ARTISANIDADE
DO ESPAÇO DE DUCHE



◀ Nueva barra de sujeción
Nova barra de suporte



◀ Unión perfiles a 45°
União perfis a 45°



◀ Detalle de unión perfiles
Detalhe de união perfis



El espacio de la ducha se transforma, convirtiéndose en el punto de partida para revalorizar el ambiente del baño con un diseño que no se limita a la concepción del producto, sino que hunde sus raíces en la experiencia y los conocimientos de diseño industrial de Novellini. Un estilo de diseño que no oculta, sino que se muestra y expresa sin decoraciones superfluas la subordinación de la forma a la honestidad de la función, confiriendo al baño un aspecto en constante evolución. Una vasta elección de combinaciones de vidrio y colores de perfil permite satisfacer incluso las personalizaciones más avanzadas.

O espaço de duche é transformado, tornando-se o ponto de partida para melhorar o ambiente da casa de banho com um design que não se limita à concepção do produto, mas que se enraíza na experiência e na perícia do design industrial da Novellini. Um estilo de design que não esconde, mas mostra-se e expressa sem decoração supérflua a subordinação da forma à honestidade da função, dando à casa de banho um aspecto sempre em evolução. Uma vasta escolha de combinações de cores de vidro e perfil pode satisfazer até mesmo a personalização mais avançada.

TRATAMIENTOS / TRATAMENTOS





HART

FLUTE / CROMO NEGRO BRILLO

HART

PANEL FIJO
PAINEL FIXO

Medidas	Código	Selección Cristales Seleção Vidros			Selección de perfiles Seleção de perfis				
		92	93	94	U	K	H	O M L	P R Q N Z
Medidas extensibilidad Medidas extensibilidade					Blanco mate Branco mate	Cromo	Negro mate	Oro brillo Oro rosa brillo Cromo negro brillo	Oro satinado Oro rosa satinado Bronce satinado Cromo nero satinado Inox satinado
A		Linea 1	Linea 2	Flute					
77↔78,5	HARTHC80-				1.048 €	1.251 €	1.251 €	1.463 €	1.399 €
87↔88,5	HARTHC90-				1.098 €	1.309 €	1.309 €	1.532 €	1.468 €
97↔98,5	HARTHC100-			-	1.148 €	1.367 €	1.367 €	1.601 €	1.537 €
117↔118,5	HARTHC120-				1.248 €	1.484 €	1.484 €	1.728 €	1.664 €
137↔138,5	HARTHC140-				1.348 €	1.601 €	1.601 €	1.855 €	1.791 €
77↔78,5	HARTHC80-				985 €	1.187 €	1.187 €	1.399 €	1.336 €
87↔88,5	HARTHC90-				1.024 €	1.235 €	1.235 €	1.458 €	1.394 €
97↔98,5	HARTHC100-	-	-		1.063 €	1.283 €	1.283 €	1.516 €	1.452 €
117↔118,5	HARTHC120-				1.142 €	1.378 €	1.378 €	1.622 €	1.558 €
137↔138,5	HARTHC140-				1.221 €	1.473 €	1.473 €	1.728 €	1.664 €

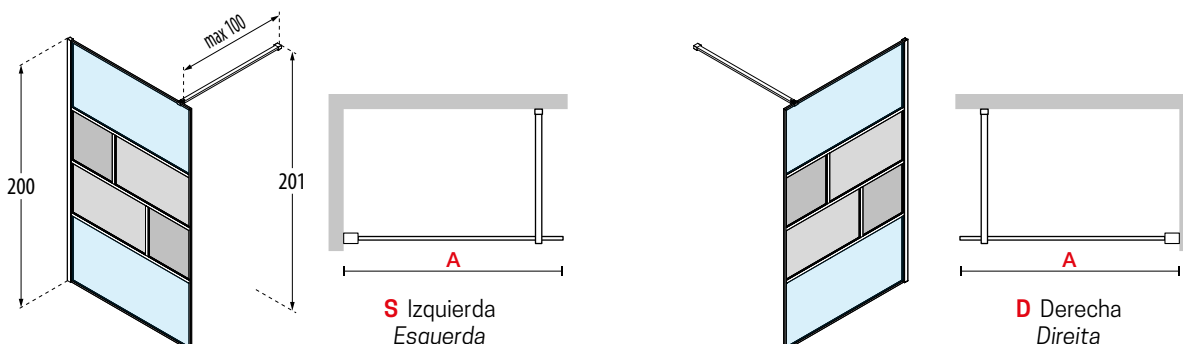
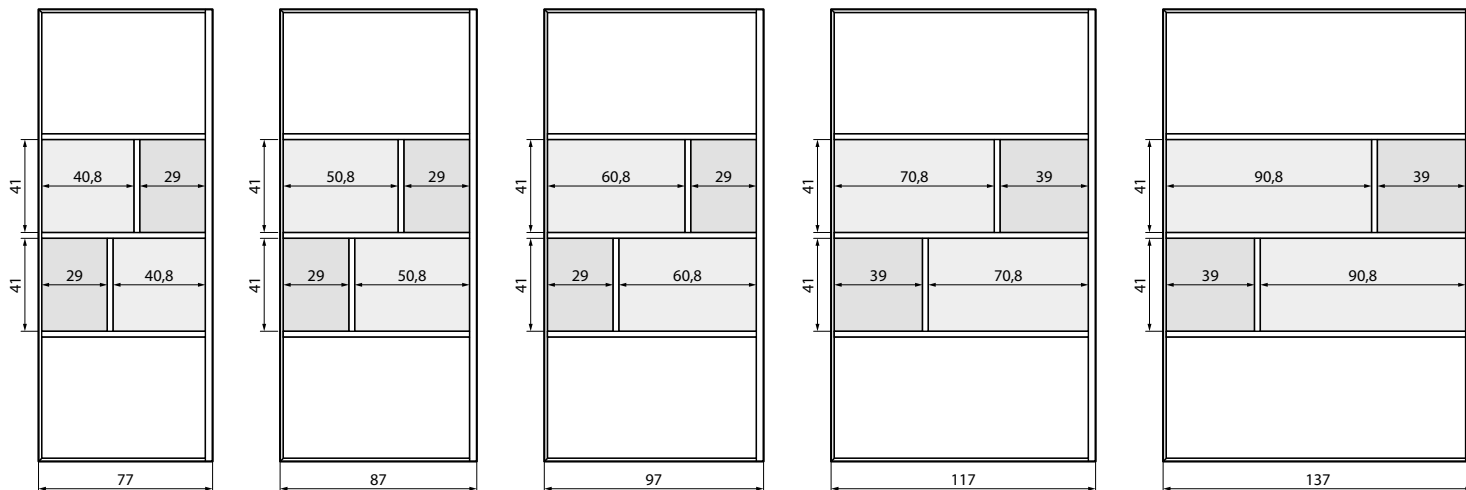



FLUTE / BRONCE SATINADO

CRISTAL TEMPLADO / VIDRO TEMPERADO



Trasparente
cod 1



Linea 1
cod 92



Linea 2
cod 93



Flute
cod 94

COLORES PERFILES / CORES PERFÍS



Blanco mate
Branco mate
cod U



Cromo
cod K



Negro mate
cod H

COLORES PERFILES "COLORATISSIMI" / CORES PERFÍS "COLORATISSIMI"



Oro brillo
cod. O



Oro rosa brillo
cod. M



Cromo negro
brillo
cod. L

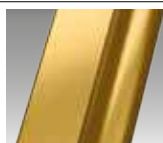

Oro satinado
cod. P



Oro rosa
satinado
cod. R

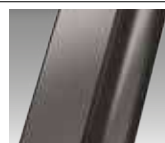

Cromo negro
satinado
cod. N

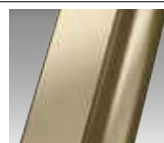

Bronce satinado
cod. Q

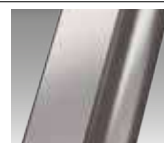

Inox
satinado
cod. Z



200 cm



6 mm



1,5 cm



PANEL FIJO
PAINEL FIXO

Medidas	Código	Selección Cristales Seleção Vidros						Selección de perfiles Seleção de perfis				
		1	44	54	92	93	94	U	K	H	O M L	P R Q N Z
Medidas extensibilidad Medidas extensibilidade		Transparente	banda satinado	Fumé Gris	Linea 1	Linea 2	Flute	Blanco mate Branco mate	Cromo	Negro mate	Oro brillo Oro rosa brillo Cromo negro brillo	Oro satinado Oro rosa satinado Bronce satinado Cromo nero satinado Inox satinado
A												
77↔78,5	HARTHP80-							651 €	784 €	784 €	938 €	890 €
87↔88,5	HARTHP90-				+ 191 €	+ 191 €	+ 106 €	673 €	811 €	811 €	970 €	922 €
97↔98,5	HARTHP100-		+ 40 €	+ 106 €				694 €	837 €	837 €	1.002 €	954 €
117↔118,5	HARTHP120-				+ 276 €	+ 276 €	+ 138 €	742 €	896 €	896 €	1.065 €	1.018 €
137↔138,5	HARTHP140-							791 €	954 €	954 €	1.129 €	1.081 €

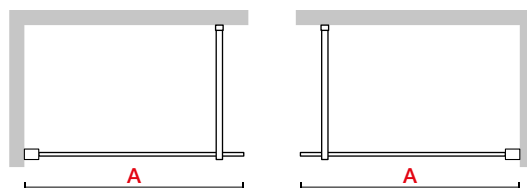
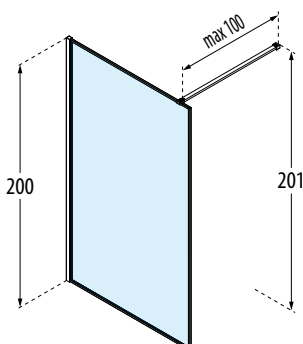



LINEA 2 / ORO ROSA BRILLO

CRISTAL TEMPLADO / VIDRO TEMPERADO



Trasparente
cod. 1



Banda satinado
cod. 44



Fumé gris
cod. 54



Linea 1
cod. 92



Linea 2
cod. 93



Flute
cod. 94

COLORES PERFILES / CORES PERFÍS



Blanco mate
Branco mate
cod. U



Cromo
cod. K



Negro mate
cod. H

COLORES PERFILES "COLORATISSIMI" / CORES PERFÍS "COLORATISSIMI"



Oro brillo
cod. O



Oro rosa brillo
cod. M



Cromo negro
brillo
cod. L

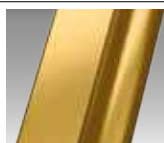

Oro satinado
cod. P



Oro rosa
satinado
cod. R

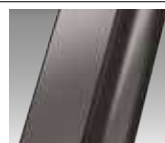

Cromo negro
satinado
cod. N

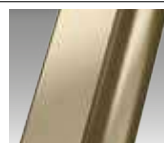

Bronce satinado
cod. Q

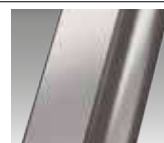

Inox
satinado
cod. Z

KUADRA H



◀ Cristales para ducha de 8 mm con la posibilidad de utilizar diferentes sistemas de sujeción a pared o techo



◀ Amplísima variedad de accesorios para poder combinar distintos elementos entre sí creando una identidad exclusiva en el baño.



◀ Diferentes opciones de decorados de cristal y acabados de perfil que permiten crear infinitos diseños personalizados

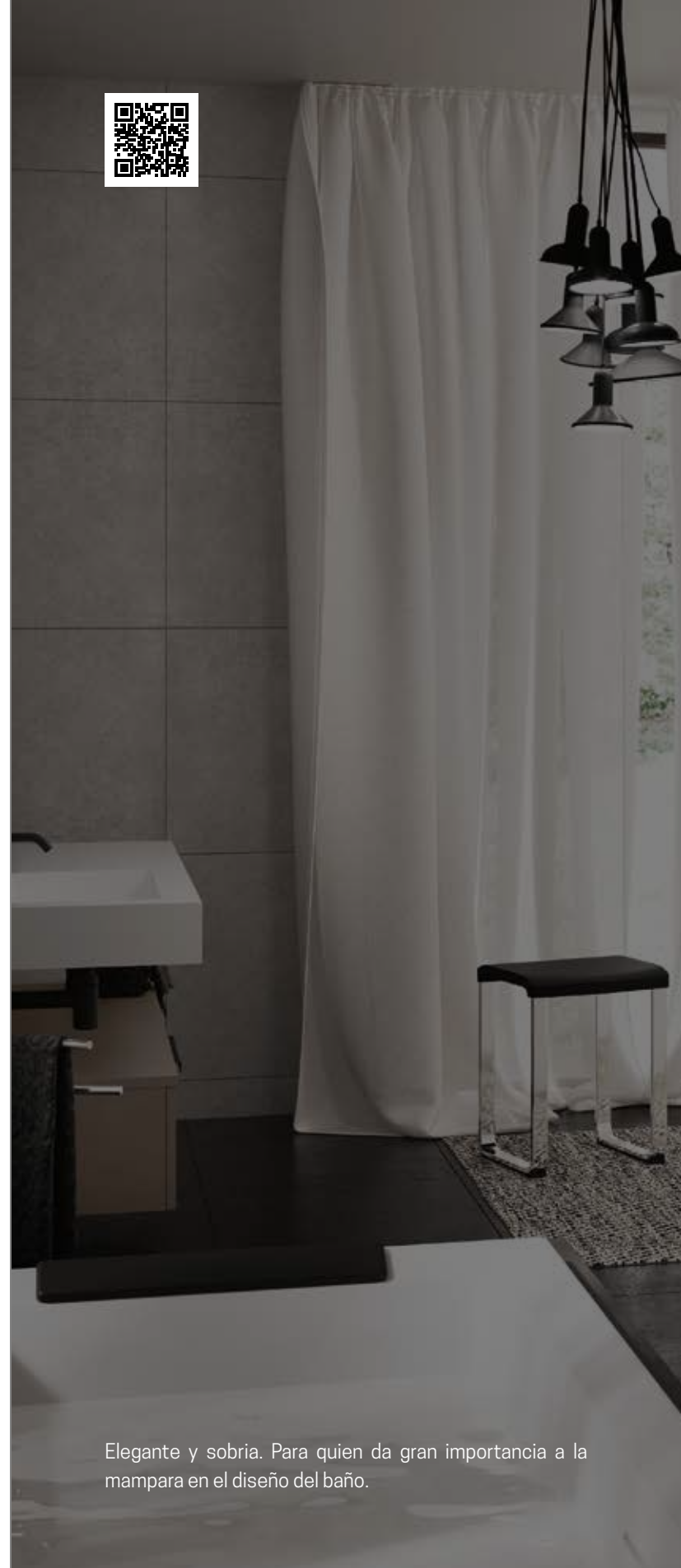

Elegante y sobria. Para quien da gran importancia a la mampara en el diseño del baño.

TRATAMIENTOS / TRATAMENTOS





KUADRA H

KUADRA H

KUADRA H



PANEL FIJO PAINEL FIXO

Medidas	Código	Selección Cristales Seleção Vidros			Selección de perfiles Seleção de perfis					
		1	44	51	U	B	K	H	O M L	P R Q N Z
Medidas extensibilidad Medidas extensibilidade										
A		Transparente	banda satinado	Ser. Ravenna	Blanco mate Branco mate	Silver Abrilantado	Cromo	Negro mate	Oro brillo Oro rosa brillo Cromo negro brillo	Oro satinado Oro rosa satinado Bronce satinado Cromo negro satinado Inox satinado
27↔30	KUADH30-				358 €	398 €	438 €	438 €	687 €	602 €
37↔40	KUADH40-				424 €	477 €	530 €	530 €	779 €	694 €
47↔50	KUADH50-				491 €	544 €	610 €	610 €	859 €	774 €
57↔60	KUADH60-				564 €	617 €	676 €	676 €	925 €	841 €
67↔70	KUADH70-				564 €	617 €	676 €	676 €	925 €	841 €
72↔75	KUADH75-				564 €	617 €	676 €	676 €	925 €	841 €
77↔80	KUADH80-				636 €	689 €	749 €	749 €	999 €	914 €
87↔90	KUADH90-	+ 40 €	+ 40 €		636 €	689 €	749 €	749 €	999 €	914 €
97↔100	KUADH100-				636 €	689 €	749 €	749 €	999 €	914 €
107↔110	KUADH110-				696 €	756 €	822 €	822 €	1.071 €	986 €
117↔120	KUADH120-				696 €	756 €	822 €	822 €	1.071 €	986 €
127↔130	KUADH130-				769 €	829 €	895 €	895 €	1.144 €	1.059 €
137↔140	KUADH140-				769 €	829 €	895 €	895 €	1.144 €	1.059 €
147↔150	KUADH150-				829 €	895 €	968 €	968 €	1.217 €	1.132 €
157↔160	KUADH160-				829 €	895 €	968 €	968 €	1.217 €	1.132 €
L 20↔180 H 80↔240 SPECIAL	KUADHSP	+ 40 €	-		1.027 €	1.127 €	1.246 €	1.246 €	-	-
L 20↔180 H 80↔240 SPECIAL	KUADHCRSP	+ 40 €	-		-	-	-	-	1.495 €	1.410 €

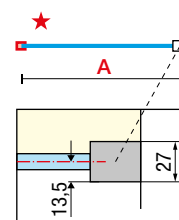
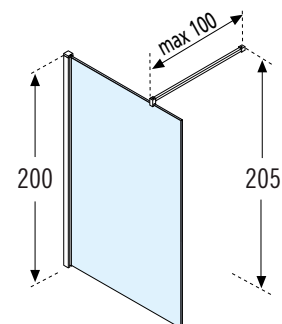

Pieza de sujeción del cristal a suelo
Peça de fixação do vidro ao chão



BARRA DE SUJECIÓN DE 100 CM INCLUIDA / BARRA DE 100 CM FARNECIDA
LA BARRA DE SUJECIÓN DE 150 CM. ES OPCIONAL (VER Pág. 308) / A BARRA DE SUJEIÇÃO DE 150 CM. É OPCIONAL (Ver pag. 308)

SISTEMA ESTABILIZADOR EVO (ENTRE PAREDES)



Color Cores	Código	Precio Preço
Blanco mate Branco mate	KUADHSFN-U	180 €
Silver Abrilantado	KUADHSFN-B	194 €
Cromo	KUADHSFN-K	216 €
Negro mate	KUADHSFN-H	216 €
Inox satinado	KUADHSFN-Z	260 €

- Barra frontal de 180 cms
- Pieza para sujeción a pared

SISTEMA ESTABILIZADOR EVO (ÁNGULO)



Color Cores	Código	Precio Preço
Blanco mate Branco mate	KUADHSF-U	243 €
Silver Abrilantado	KUADHSF-B	262 €
Cromo	KUADHSF-K	283 €
Negro mate	KUADHSF-H	283 €

- Barra frontal de 180 cms
- Barra lateral de 120 cms
- Piezas para sujeción a pared
- 1 pieza para la unión angular

PERFIL PARA FIJACIÓN A TECHO PERFIL DE FIJACIÓN AO TETO



Color Cores	Código	Precio Preço
Blanco Branco	R80GKHSOF-D	201 €
Blanco mate Branco mate	R80GKHSOF-U	201 €
Silver Abrilantado	R80GKHSOF-B	222 €
Cromo	R80GKHSOF-K	244 €
Negro mate	R80GKHSOF-H	244 €
Inox satinado	R80GKHSOF-Z	293 €



CRISTAL TEMPLADO / VIDRO TEMPERADO



Transparente
cod. 1



Banda satinado
cod. 44

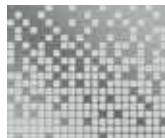

Ser. Ravenna
cod. 51

COLORES PERFILES / CORES PERFÍS



Blanco mate
Branco mate
cod. U



Silver
Abrillantado
cod. B



Cromo
cod. K



Negro mate
cod. H

COLORES PERFILES "COLORATISSIMI" / CORES PERFÍS "COLORATISSIMI"

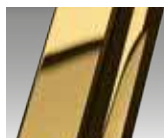

Oro brillo
cod. O



Oro rosa brillo
cod. M



Cromo negro
brillo
cod. L



Oro satinado
cod. P

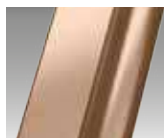

Oro rosa
satinado
cod. R



Cromo negro
satinado
cod. N

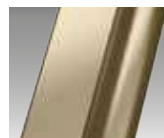

Bronce satinado
cod. Q

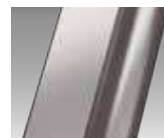

Inox
satinado
cod. Z

KUADRA HFA

PUERTA GIRATORIA PARA PANEL FIJO



200 cm



8 mm



Reversible
cristal



No reversible
Não reversível
transparente



CRISTAL TEMPLADO VIDRO TEMPERADO

Transparente
cod. 1

Banda
satinado
cod. 44

Spy
cod. 76

COLORES PERFILES CORES PERFÍS

Blanco mate
Branco mate
cod. U

Cromo
cod. K

Negro mate
cod. H

COLORATISSIMI

Oro brillo
cod. O

Oro rosa
brillo
cod. M

Cromo
negro brillo
cod. L

Oro satinado
cod. P

Oro rosa
satinado
cod. R

Cromo negro
satinado
cod. N

Bronce
satinado
cod. Q

Inox
satinado
cod. Z

Medidas	Código	Selección Cristales Seleção Vidros		Selección de perfiles Seleção de perfis						Selección Cristales Seleção Vidros	Selección de perfiles Seleção de perfis							
		1	44	U	K	H	O M L	P R Q N Z	76		U	K	H	Z				
Medidas extensibilidad Medidas extensibilidade																		
A		Transpa- rente	banda satinado	Blanco mate Branco mate	Cromo	Negro mate	Oro brillo Oro rosa brillo Cromo negro brillo	Oro satinado Oro rosa satinado Bronce satinado Cromo negro satinado Inox satinado	Spy	Blanco mate Branco mate	Cromo	Negro mate	Inox satinado					
37	KUADHA37-		-	305 €	305 €	305 €	398 €	367 €		389 €	367 €	367 €	440 €					
37	KUADHA37D-		+40 €	305 €	305 €	305 €	398 €	367 €										
37	KUADHA37S-			305 €	305 €	305 €	398 €	367 €										

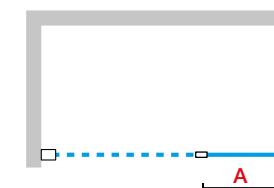
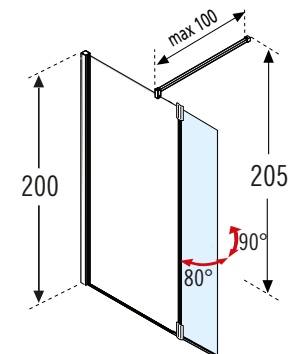

Código

+

Cristales
Vidros

+

Perfiles
Perfis

=

Código completo del producto
Código completo do produto

KUADRA HFP2

PUERTA GIRATORIA PARA PANEL FIJO



200 cm



6 mm



CRISTAL TEMPLADO VIDRO TEMPERADO



Trasparente
cod. 1



Banda
satinado
cod. 44

COLORES PERFILES CORES PERFIS



Blanco mate
Branco mate
cod. U



Silver
Abrillantado
cod. B



Cromo
cod. K



Negro mate
cod. H

Medidas	Código	Selección Cristales Seleção Vidros		Selección de perfiles Seleção de perfis			
		1	44	U	B	K	H
Medidas extensibilidad Medidas extensibilidade		Transparente	banda satinado	Blanco mate Branco mate	Silver Abrillantado	Cromo	Negro mate
A							
40	KUADHAP37-		+ 42 €	307 €	338 €	371 €	371 €

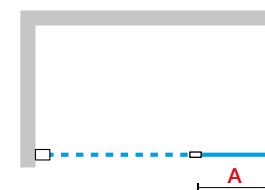
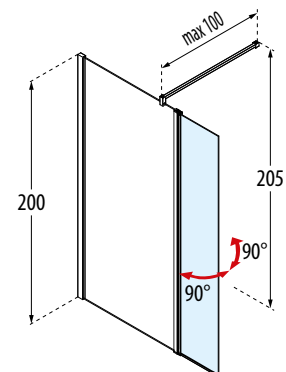

Construcción del código: **Código** + **Cristales Vidros** + **Perfiles Perfis** = Código completo del producto
 Construção do código: **Código** + **Cristales Vidros** + **Perfiles Perfis** = Código completo do produto

KUADRA H DESIGN



PANEL FIJO
PAINEL FIXO

Medidas	Código	Selección Cristales Seleção Vidros					Selección de perfiles Seleção de perfis
Medidas extensibilidad Medidas extensibilidade		81	82	84	85	86	H
A		Squares	Stripes	Ser. Wires	Ser. Plaid	Ser. Frame	Negro mate
27↔30	KUADH30-	-	-				570 €
37↔40	KUADH40-	-	-				663 €
47↔50	KUADH50-	-	-				742 €
57↔60	KUADH60-	-	-				809 €
67↔70	KUADH70-	-	-				809 €
72↔75	KUADH75-	-	-				809 €
77↔80	KUADH80-						882 €
87↔90	KUADH90-						882 €
97↔100	KUADH100-						882 €
107↔110	KUADH110-	-	-				954 €
117↔120	KUADH120-						954 €
127↔130	KUADH130-	-	-				1.027 €
137↔140	KUADH140-						1.027 €
147↔150	KUADH150-	-	-				1.100 €
157↔160	KUADH160-						1.100 €

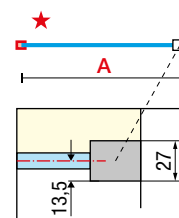
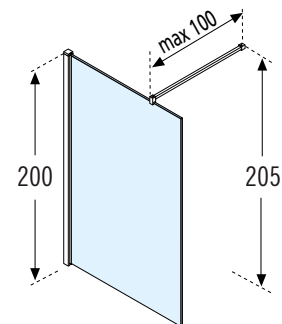

Pieza de sujeción del cristal a suelo
Peça de fixação do vidro ao chão

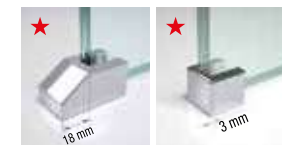

BARRA DE SUJECIÓN DE 100 CM INCLUIDA / BARRA DE 100 CM FARNECIDA
LA BARRA DE SUJECIÓN DE 150 CM. ES OPCIONAL (VER Pág. 308) / A BARRA DE SUJEIÇÃO DE 150 CM. É OPCIONAL (Ver pag. 308)

SISTEMA ESTABILIZADOR EVO
(ENTRE PAREDES)



Color Cores	Código	Precio Preço
Blanco mate Branco mate	KUADHSFN-U	180 €
Silver Abrilantado	KUADHSFN-B	194 €
Cromo	KUADHSFN-K	216 €
Negro mate	KUADHSFN-H	216 €
Inox satinado	KUADHSFN-Z	260 €

- Barra frontal de 180 cms
- Pieza para sujeción a pared

SISTEMA ESTABILIZADOR EVO
(ÁNGULO)



Color Cores	Código	Precio Preço
Blanco mate Branco mate	KUADHSF-U	243 €
Silver Abrilantado	KUADHSF-B	262 €
Cromo	KUADHSF-K	283 €
Negro mate	KUADHSF-H	283 €

- Barra frontal de 180 cms
- Barra lateral de 120 cms
- Piezas para sujeción a pared
- 1 pieza para la unión angular

PERFIL PARA FIJACIÓN A TECHO
PERFIL DE FIJACIÓN AO TETO



Color Cores	Código	Precio Preço
Blanco Branco	R80GKHSOF-D	201 €
Blanco mate Branco mate	R80GKHSOF-U	201 €
Silver Abrilantado	R80GKHSOF-B	222 €
Cromo	R80GKHSOF-K	244 €
Negro mate	R80GKHSOF-H	244 €
Inox satinado	R80GKHSOF-Z	293 €

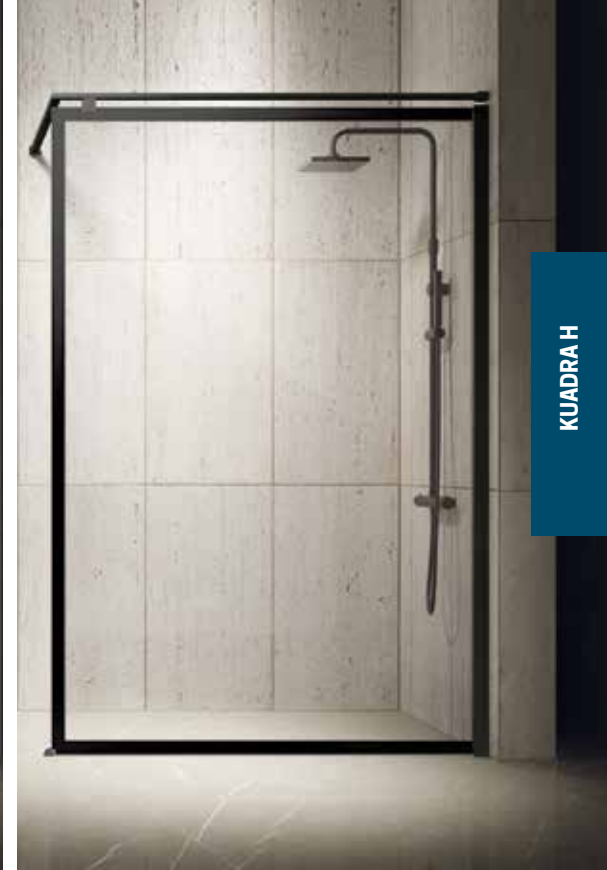

DIMENSIONES SQUARES

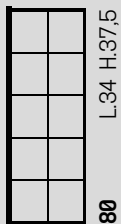

80

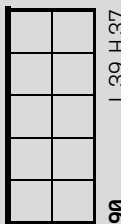

90

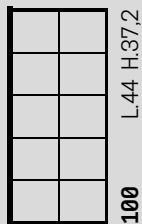

100

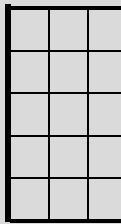

120

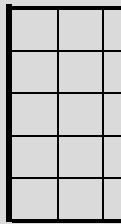

140

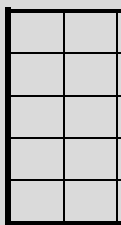

160



CRISTAL TEMPLADO / VIDRO TEMPERADO



Serigrafía Wires
cod. 84

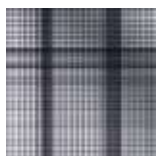

Serigrafía Plaid
cod. 85



Serigrafía Frame
cod. 86

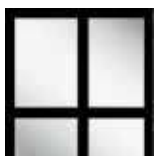

Squares
cod. 81

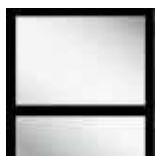

Stripes
cod. 82

COLORES PERFILES / CORES PERFÍS



Negro mate
cod. H

KUADRA H FUMÈ



200 cm



8 mm



3 cm



PANEL FIJO
PAINEL FIXO

Medidas	Código	Selección Cristales Seleção Vidros		Selección de perfiles Seleção de perfis				
		54	87	U	B	K	H	Z
Medidas extensibilidad Medidas extensibilidade								
A		Fumé Gris	banda black	Blanco mate Branco mate	Silver Abrilantado	Cromo	Negro mate	Inox satinado
67↔70	KUADH70-			696 €	752 €	813 €	813 €	977 €
77↔80	KUADH80-			776 €	837 €	905 €	905 €	1.070 €
87↔90	KUADH90-			776 €	837 €	905 €	905 €	1.070 €
97↔100	KUADH100-		+ 132 €	776 €	837 €	905 €	905 €	1.070 €
117↔120	KUADH120-			842 €	909 €	983 €	983 €	1.147 €
137↔140	KUADH140-			928 €	1.002 €	1.083 €	1.083 €	1.248 €
L 20↔180 H 80↔240 SPECIAL	KUADHSP		+ 132 €	1.279 €	1.398 €	1.524 €	1.524 €	1.689 €

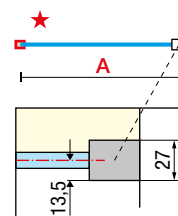
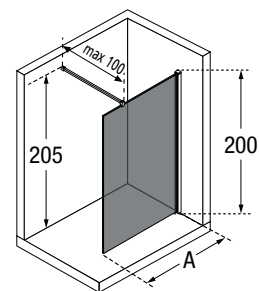

Pieza de sujeción del cristal a suelo
Peça de fixação do vidro ao chão



BARRA DE SUJECIÓN DE 100 CM INCLUIDA / BARRA DE 100 CM FARNECIDA
LA BARRA DE SUJECIÓN DE 150 CM. ES OPCIONAL (VER Pág. 308) / A BARRA DE SUJEIÇÃO DE 150 CM. É OPCIONAL (Ver pag. 308)

SISTEMA ESTABILIZADOR EVO
(ENTRE PAREDES)



Color Cores	Código	Precio Preço
Blanco mate Branco mate	KUADHSFN-U	180 €
Silver Abrilantado	KUADHSFN-B	194 €
Cromo	KUADHSFN-K	216 €
Negro mate	KUADHSFN-H	216 €
Inox satinado	KUADHSFN-Z	260 €

- Barra frontal de 180 cms
- Pieza para sujeción a pared

SISTEMA ESTABILIZADOR EVO
(ÁNGULO)



Color Cores	Código	Precio Preço
Blanco mate Branco mate	KUADHSF-U	243 €
Silver Abrilantado	KUADHSF-B	262 €
Cromo	KUADHSF-K	283 €
Negro mate	KUADHSF-H	283 €

- Barra frontal de 180 cms
- Barra lateral de 120 cms
- Piezas para sujeción a pared
- 1 pieza para la unión angular

PERFIL PARA FIJACIÓN A TECHO
PERFIL DE FIJACIÓN AO TETO



Color Cores	Código	Precio Preço
Blanco Branco	R80GKHSOF-D	201 €
Blanco mate Branco mate	R80GKHSOF-U	201 €
Silver Abrilantado	R80GKHSOF-B	222 €
Cromo	R80GKHSOF-K	244 €
Negro mate	R80GKHSOF-H	244 €
Inox satinado	R80GKHSOF-Z	293 €



KUADRA H

CRISTAL FUMÉ + BARRA EVO (OPCIONAL VER PAG. 308)



CRISTAL FUMÉ CON BANDA BLACK + BARRA A TECHO (OPCIONAL VER PAG. 308)

CRISTAL TEMPLADO / VIDRO TEMPERADO

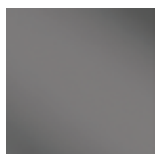

Fumé Gris
cod. 54



Banda black
cod. 87

COLORES PERFILES / CORES PERFÍS



Blanco mate
Branco mate
cod. U

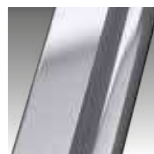

Silver
Abrillantado
cod. B



Cromo
cod. K



Negro mate
cod. H



Inox satinado
cod. Z

KUADRA H SPY

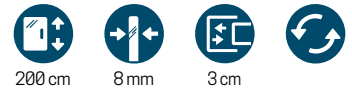

PANEL FIJO
PAINEL FIXO



CRISTAL TEMPLADO
VIDRO TEMPERADO



COLORES PERFILES
CORES PERFÍS

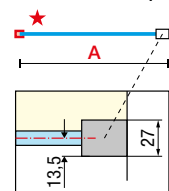
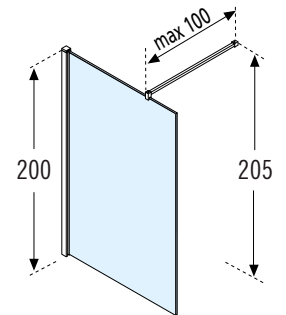
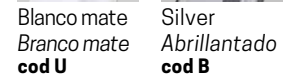

Pieza de sujeción del cristal a suelo
Peça de fixação do vidro ao chão

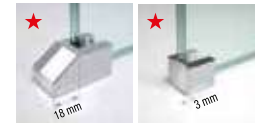

Medidas	Código	Selección Cristales	Selección de perfiles				
		Seleção Vidros	U	B	K	H	Z
Medidas extensibilidad Medidas extensibilidade		76					
A		Spy	Blanco mate Branco mate	Silver Abrillantado	Cromo	Negro mate	Inox
27↔30	KUADH30-		524 €	570 €	623 €	623 €	788 €
37↔40	KUADH40-		603 €	656 €	716 €	716 €	880 €
47↔50	KUADH50-		670 €	729 €	795 €	795 €	959 €
57↔60	KUADH60-		723 €	789 €	862 €	862 €	1.026 €
67↔70	KUADH70-		736 €	802 €	875 €	875 €	1.039 €
77↔80	KUADH80-		776 €	848 €	928 €	928 €	1.092 €
87↔90	KUADH90-		875 €	954 €	1.047 €	1.047 €	1.212 €
97↔100	KUADH100-		921 €	1.007 €	1.100 €	1.100 €	1.265 €
117↔120	KUADH120-		1.027 €	1.127 €	1.233 €	1.233 €	1.397 €
L 20↔180 H 80†240 SPECIAL	KUADHSP		1.404 €	1.531 €	1.677 €	1.677 €	1.841 €

LA BARRA DE SUJECIÓN DE 150 CM. ES OPCIONAL (VER PÁG. 308) / A BARRA DE SUJEIÇÃO DE 150 CM. É OPCIONAL (VER PAG. 308)

OPCIONAL

NUEVO SISTEMA ESTABILIZADOR EVO (entre paredes)

- Barra frontal de 180 cms
- Pieza para sujeción a pared

Color Cores	Código	Precio Preço
Blanco mate Branco mate	KUADHSFN-U	180 €
Silver Abrillantado	KUADHSFN-B	194 €
Cromo	KUADHSFN-K	216 €
Negro mate	KUADHSFN-H	216 €
Inox satinado	KUADHSFN-Z	260 €

NUEVO SISTEMA ESTABILIZADOR EVO (ángulo)

- Barra frontal de 180 cms
- Barra lateral de 120 cms
- Piezas para sujeción a pared
- 1 pieza para la unión angular

Color Cores	Código	Precio Preço
Blanco mate Branco mate	KUADHSF-U	243 €
Silver Abrillantado	KUADHSF-B	262 €
Cromo	KUADHSF-K	283 €
Negro mate	KUADHSF-H	283 €
Inox satinado	KUADHSF-Z	340 €

KUADRA HF

PANEL FIJO A UNA SOLA PARED
PAINEL FIXO CENTRO PAREDE



200 cm



8 mm



SISTEMA EVO EN FORMA DE "C" (OPTIONAL)

CRISTAL TEMPLADO VIDRO TEMPERADO



Transparente
cod. 1



Ser. Ravenna
cod. 51



Spy
cod. 76

COLORES PERFILES CORES PERFIS



Blanco mate
Branco mate
cod U



Silver
Abrillantado
cod B



Cromo
cod K



Negro mate
cod H



Inox
satinado
cod Z

Medidas	Código	Selección Cristales Seleção Vidros		Selección de perfiles Seleção de perfis					Selección Cristales Seleção Vidros	Selección de perfiles Seleção de perfis						
		1	51	U	B	K	H	Z		76	U	B	K	H	Z	
Medidas extensibilidad Medidas extensibilidade																
C		Transparente	Ser. Ravenna	Blanco mate Branco mate	Silver Abrillantado	Cromo	Negro mate	Inox	Spy	Blanco mate Branco mate	Silver Abrillantado	Cromo	Negro mate	Inox		
94	KUADFC96-			696 €	756 €	822 €	822 €	986 €		921 €	950 €	1.038 €	1.038 €	1.193 €		
114	KUADFC116-			723 €	782 €	848 €	848 €	1.012 €		1.027 €	1.063 €	1.163 €	1.163 €	1.318 €		
134	KUADFC136-			776 €	835 €	901 €	901 €	1.065 €								
154	KUADFC156-			815 €	882 €	954 €	954 €	1.118 €								
L 80↔180 H 80↑240 SPECIAL	KUADFCSP			1.213 €	1.325 €	1.445 €	1.445 €	1.609 €								

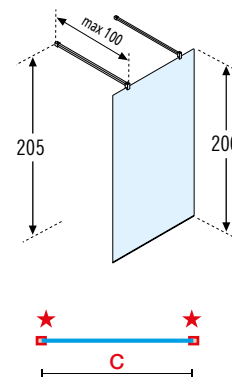

LA BARRA DE SUJECIÓN DE 150 CM. ES OPCIONAL (VER PÁG. 308) / A BARRA DE SUJEIÇÃO DE 150 CM. É OPCIONAL (VER PAG. 308)

OPCIONAL



SISTEMA ESTABILIZADOR EVO (EN C)

1 barra frontal de 180 cm
2 barras laterales de 120 cm
4 piezas de fijación al cristal
2 piezas para la unión angular

Color/Cores	Código	Precio/Preço
Blanco mate/Branco mate	KUADHSFC-U	315 €
Silver/Abrillantado	KUADHSFC-B	329 €
Cromo	KUADHSFC-K	349 €
Negro mate	KUADHSFC-H	349 €
Inox satinado	KUADHSFC-Z	419 €

Pieza de sujeción del cristal a suelo
Peça de fixação do vidro ao chão



Construcción del código:
Construção do código:

Código

+

Cristales
Vidros

+

Perfiles
Perfis

=

Código completo del producto
Código completo do produto

KUADRA HL

PANEL FIJO
PAINEL FIXO



CRISTAL TEMPLADO VIDRO TEMPERADO



COLORES PERFILES CORES PERFÍS



Medidas	Código	Selección Cristales Seleção Vidros			Selección de perfiles Seleção de perfis					Selección Cristales Seleção Vidros	Selección de perfiles Seleção de perfis				
		1	44	51	U	B	K	H	Z		76	U	B	K	H
Medidas extensibilidad Medidas extensibilidade		Transparente	banda satinado	Ser. Ravenna	Blanco mate Branco mate	Silver Abrillatado	Cromo	Negro mate	Inox satinado	Spy	Blanco mate Branco mate	Silver Abrillatado	Cromo	Negro mate	Inox satinado

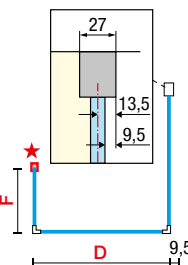
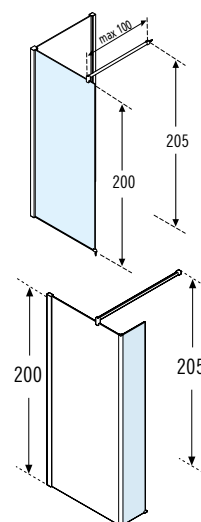

Pieza de sujeción del cristal a suelo
Peça de fixação do vidro ao chão



FIJO / FIXO																
D																
68	KUADHL70-				438 €	484 €	544 €	544 €	708 €		603 €	625 €	682 €	682 €	837 €	
78	KUADHL80-				464 €	511 €	570 €	570 €	735 €		636 €	657 €	719 €	719 €	874 €	
88	KUADHL90-				491 €	537 €	597 €	597 €	761 €		723 €	744 €	813 €	813 €	968 €	
98	KUADHL100-	+ 40 €	+ 40 €		517 €	564 €	623 €	623 €	788 €		749 €	775 €	850 €	850 €	1.005 €	
118	KUADHL120-				544 €	590 €	650 €	650 €	814 €		848 €	875 €	957 €	957 €	1.112 €	
138	KUADHL140-				570 €	617 €	676 €	676 €	841 €	-						
158	KUADHL160-				597 €	643 €	703 €	703 €	867 €							
KUADRA HL																
F																
15	KUADHL15-				186 €	206 €	226 €	226 €	270 €							
30	KUADHL30-	+ 40 €			206 €	226 €	246 €	246 €	295 €							
40	KUADHL40-				232 €	252 €	272 €	272 €	326 €							
L 15↔160 H 80↗240 SPECIAL	KUADHLSP				875 €	948 €	1.133 €	1.133 €	1.297 €		1.186 €	1.219 €	1.332 €	1.332 €	1.487 €	

LA BARRA DE SUJECCIÓN DE 150 CM. ES OPCIONAL (VER PÁG. 308)
A BARRA DE SUJEIÇÃO DE 150 CM. É OPCIONAL (VER PAG. 308)

OPCIONES

KUADRA H+HFA VERSIÓN ENTRE PAREDES / VERSÃO ENTRE PAREDES

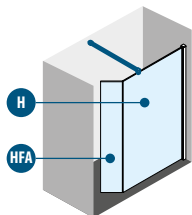

KUADRA H
KUADRA HFA
BARRA ESTABILIZADORA
SUMINISTRADA DE SERIE

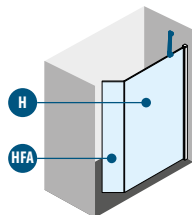

KUADRA H
KUADRA HFA
BARRA ORIENTABLE

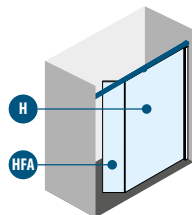

KUADRA H
KUADRA HFA
BARRA EVO
(entre paredes)

KUADRA H+HFA VERSIÓN / VERSÃO EN ÁNGULO

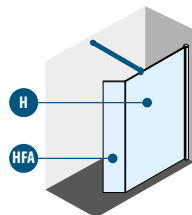

KUADRA H
KUADRA HFA
BARRA ESTABILIZADORA
SUMINISTRADA DE SERIE

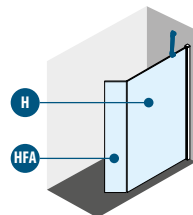

KUADRA H
KUADRA HFA
BARRA ORIENTABLE

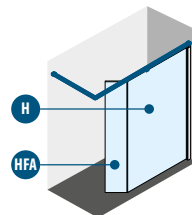

KUADRA H
KUADRA HFA
BARRA EVO (ángulo)

KUADRA H+HFP2 VERSIÓN ENTRE PAREDES / VERSÃO ENTRE PAREDES

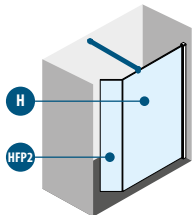

KUADRA H
KUADRA HFP2
BARRA ESTABILIZADORA
SUMINISTRADA DE SERIE

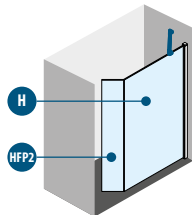

KUADRA H
KUADRA HFP2
BARRA ORIENTABLE

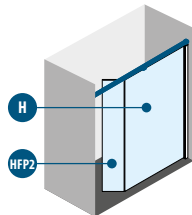

KUADRA H
KUADRA HFP2
BARRA EVO
(entre paredes)

KUADRA H+HFP2 VERSIÓN / VERSÃO EN ÁNGULO

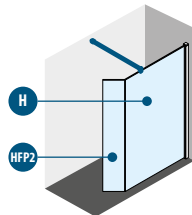

KUADRA H
KUADRA HFP2
BARRA ESTABILIZADORA
SUMINISTRADA DE SERIE

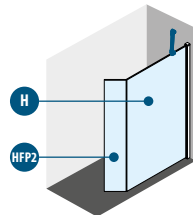

KUADRA H
KUADRA HFP2
BARRA ORIENTABLE

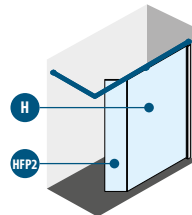

KUADRA H
KUADRA HFP2
BARRA EVO (ángulo)

KUADRA H+H VERSIÓN / VERSÃO EN ÁNGULO

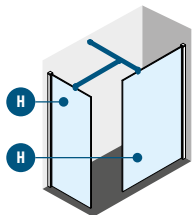

KUADRA H x2
BARRA ESTABILIZADORA
SUMINISTRADA DE SERIE

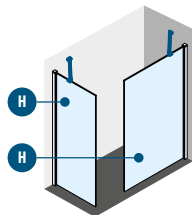

KUADRA H x2
BARRA ORIENTABLE

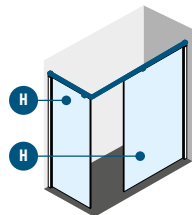

KUADRA H x2
BARRA EVO (ángulo)

KUADRA H4 VERSIÓN A UNA SOLA PARED / VERSÃO CENTRO PARED

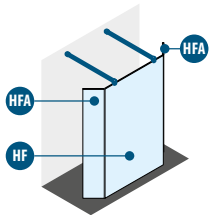

KUADRA HF
KUADRA HFA x2
BARRA ESTABILIZADORA
SUMINISTRADA DE SERIE

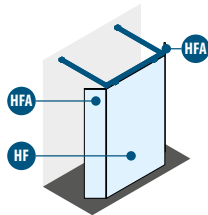

KUADRA HF
KUADRA HFA x2
BARRA EVO (a U)

KUADRA H4 VERSIÓN ENTRE PAREDES / VERSÃO ENTRE PAREDES

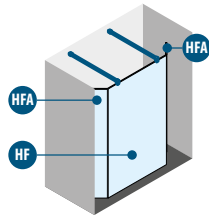

KUADRA HF
KUADRA HFA x2
BARRA ESTABILIZADORA
SUMINISTRADA DE SERIE

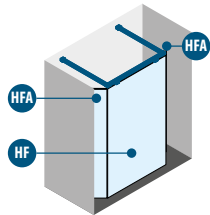

KUADRA HF
KUADRA HFA x2
BARRA EVO (a U)

KUADRA H5 VERSIÓN A UNA SOLA PARED / VERSÃO CENTRO PARED

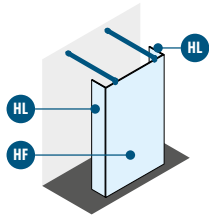

KUADRA HF
KUADRA HL x2
BARRA ESTABILIZADORA
SUMINISTRADA DE SERIE

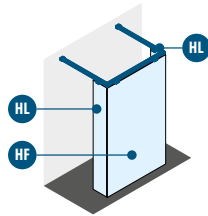

KUADRA HF
KUADRA HL x2
BARRA ESTABILIZADORA
SUMINISTRADA DE SERIE

KUADRA H5 VERSIÓN ENTRE PAREDES / VERSÃO ENTRE PAREDES

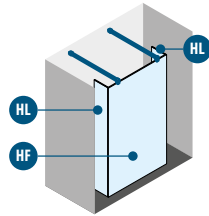

KUADRA HF
KUADRA HL x2
BARRA ESTABILIZADORA
SUMINISTRADA DE SERIE

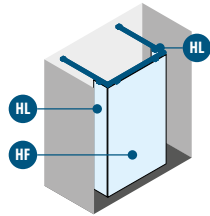

KUADRA HF
KUADRA HL x2
BARRA ESTABILIZADORA
SUMINISTRADA DE SERIE

OPCIONES

KUADRA H6 VERSIÓN ENTRE PAREDES / VERSÃO ENTRE PAREDES

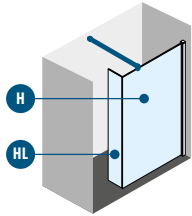

KUADRA H
KUADRA HL
BARRA ESTABILIZADORA
SUMINISTRADA DE SERIE

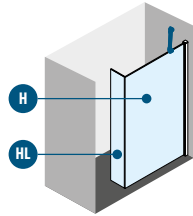

KUADRA H
KUADRA HL
BARRA ORIENTABLE

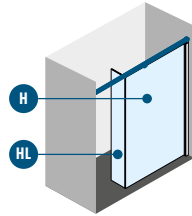

KUADRA H
KUADRA HL
BARRA EVO (in nicchia)

KUADRA H6 VERSIÓN / VERSÃO EN ÁNGULO

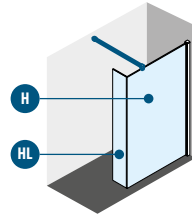

KUADRA H
KUADRA HL
BARRA ESTABILIZADORA
SUMINISTRADA DE SERIE

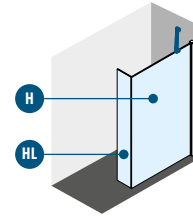

KUADRA H
KUADRA HL
BARRA ORIENTABLE

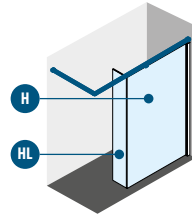

KUADRA H
KUADRA HL
BARRA EVO (ángulo)

KUADRA H7 VERSIÓN / VERSÃO EN ÁNGULO

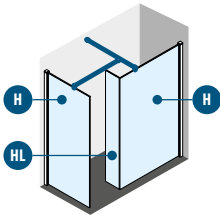

KUADRA H x2
KUADRA HL
BARRA ESTABILIZADORA
SUMINISTRADA DE SERIE

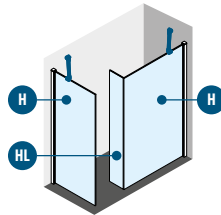

KUADRA H x2
KUADRA HL
BARRA ORIENTABLE

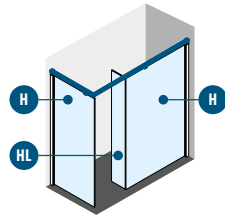

KUADRA H x2
KUADRA HL
BARRA EVO (ángulo)

KUADRA H9 VERSIÓN ENTRE PAREDES / VERSÃO ENTRE PAREDES

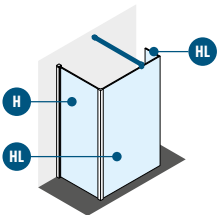

KUADRA HL x2
KUADRA H
BARRA ESTABILIZADORA
SUMINISTRADA DE SERIE

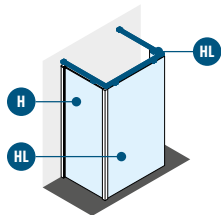

KUADRA HL x2
KUADRA H
BARRA EVO (a U)

KUADRA H9 VERSIÓN / VERSÃO EN ÁNGULO

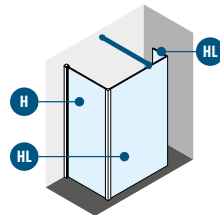

KUADRA HL x2
KUADRA H
BARRA ESTABILIZADORA
SUMINISTRADA DE SERIE

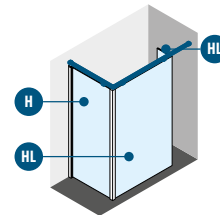

KUADRA HL x2
KUADRA H
BARRA EVO (ángulo)

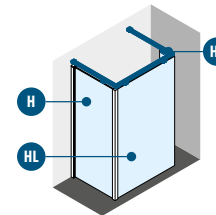

KUADRA HL x2
KUADRA H
BARRA EVO (a U)

BARRA ESTABILIZADORA SUMINISTRADA DE SERIE



Barra de sujeción 100 cm
Barra de fixação 100 cm

MEDIDAS QUE OCUPAN LOS PERFILES EN LA PARED ESPAÇO QUE OCUPAN OS PERFIS NA PAREDE

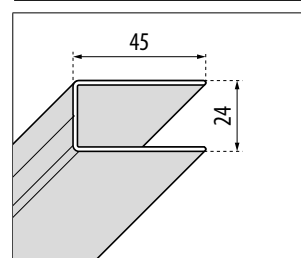

a pared

Color/Cor	Código
Blanco/Branco	P01KUHST-A
Silver/Abrillantado	P01KUHST-B
Cromo	P01KUHST-K
Negro	P01KUHST-H
Inox satinado	P01KUHST-Z

PARA TODAS LAS DEMÁS BARRAS DE SUJECIÓN - VÉASE LA PÁGINA 308

DATOS TÉCNICOS / DADOS TÉCNICOS

COLORES PERFILES / CORES PERFÍS



Blanco mate
Branco mate
cod. U



Silver
Abrillantado
cod. B



Cromo
cod. K



Negro mate
cod. H

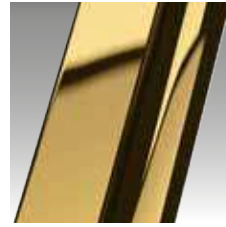

Oro brillo
cod. O



Oro rosa
brillo
cod. M



Cromo
negro brillo
cod. L

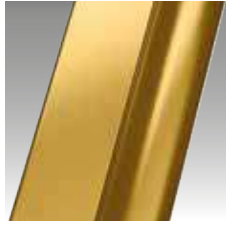

Oro satinado
cod. P



Oro rosa satinado
cod. R



Cromo negro
satinado
cod. N

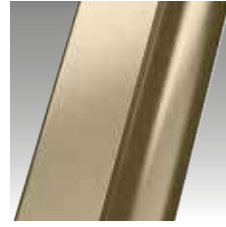

Bronce satinado
cod. Q



Inox
satinado
cod. Z

CRISTAL / VIDRO 8 mm (European standards UNE EN 14428)



Transparente 
cod. 1



Espejo (SPY)
cod. 76



Fumé
cod. 54

SERIGRAFIA



Ravenna
cod. 51



Squares
cod. 81



Stripes
cod. 82



Frame
cod. 86



Wires
cod. 84

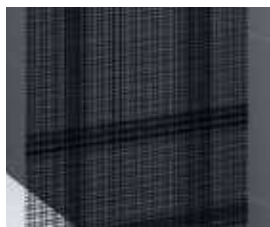

Plaid
cod. 85



Banda black
cod. 87



Banda Satinado
cod. 44

KUADRA H FRAME



◀ Toallero



◀ Repisa porta objetos



◀ Repisa interior y toallero exterior

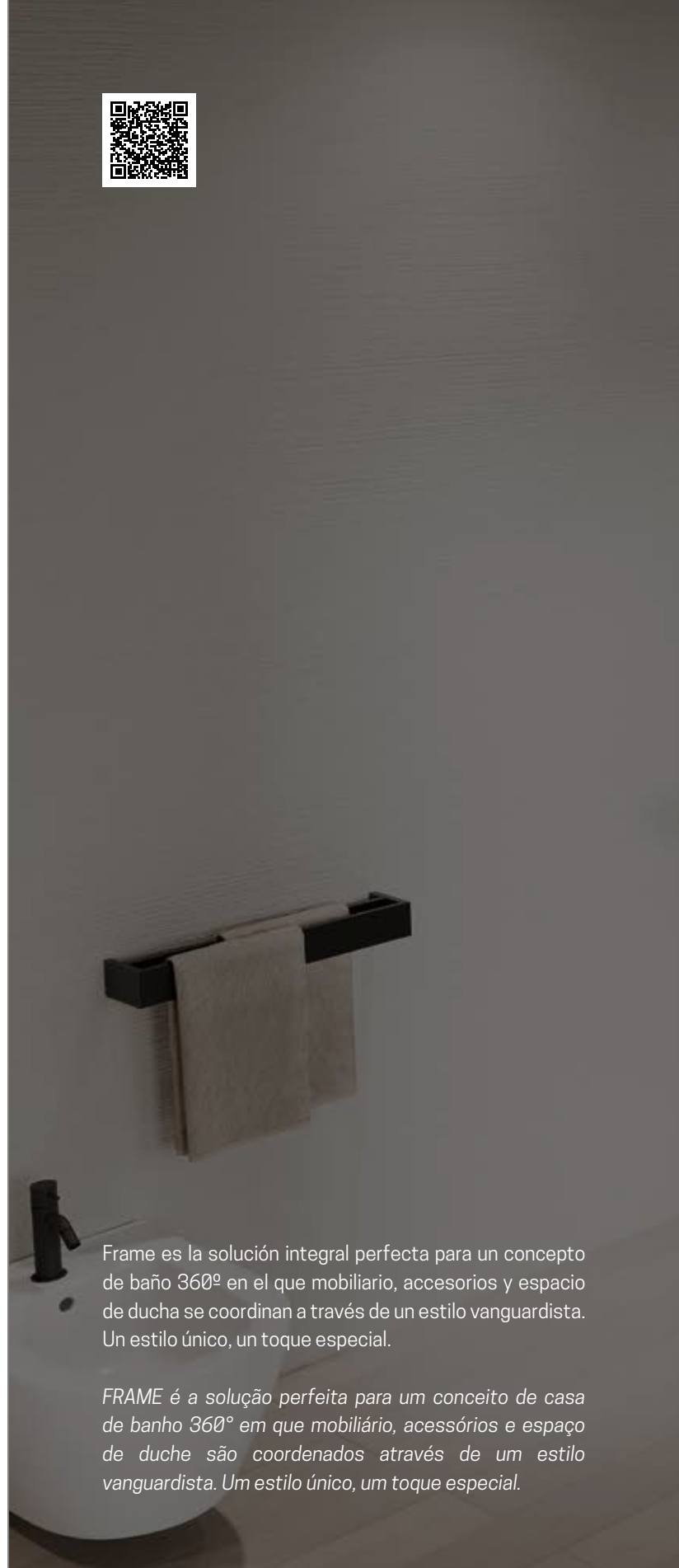

Frame es la solución integral perfecta para un concepto de baño 360° en el que mobiliario, accesorios y espacio de ducha se coordinan a través de un estilo vanguardista. Un estilo único, un toque especial.

FRAME é a solução perfeita para um conceito de casa de banho 360° em que mobiliário, acessórios e espaço de duche são coordenados através de um estilo vanguardista. Um estilo único, um toque especial.

TRATAMIENTOS / TRATAMENTOS





KUADRA H FRAME

KUADRA H KIT FRAME

VERSIÓN BARRA EXTERNA FRAME + TOALLERO

PRECIO REFERIDO AL KIT FRAME. PEDIR CONJUNTAMENTE CON FIJO KUADRA H HASTA UNA ANCHURA MÁXIMA DE 180 CM

Medidas	Código	instalación		Selección de color / precio Seleção de cores de acabados / Preço					
		Derecha Direita	Izquierda Esquerda	U	B	H	K	O M L	P R Q N Z
		D-	S-						
				Blanco mate Branco mate	Silver Abrillantado	Negro mate	Cromo	Oro brillo Oro rosa brillo Cromo negro brillo	Oro satinado Oro rosa satinado Bronce satinado Cromo negro satinado Inox satinado
Max 140	R80KUFRE10			608 €	670 €	739 €	739 €	961 €	887 €
Max 180	R80KUFRE1018			670 €	736 €	815 €	815 €	1.060 €	978 €

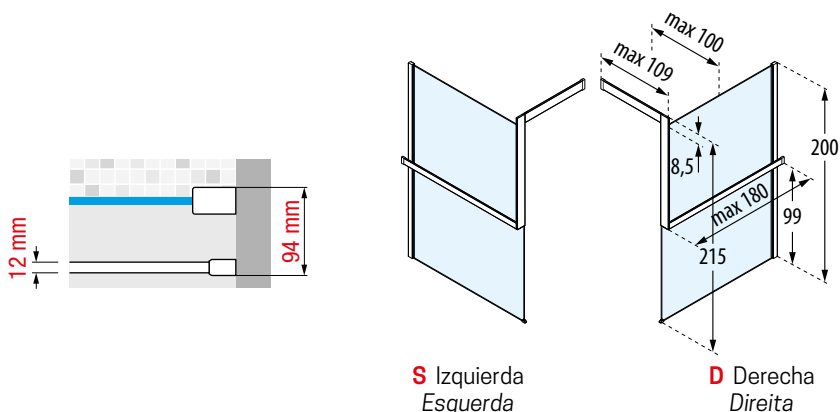

VERSIÓN BARRA EXTERNA FRAME A TECHO + TOALLERO

Medidas	Código	instalación		Selección de color / precio Seleção de cores de acabados / Preço					
		Derecha Direita	Izquierda Esquerda	U	B	H	K	O M L	P Z R Q N
		D-	S-						
				Blanco mate Branco mate	Silver Abrillantado	Negro mate	Cromo	Oro brillo Oro rosa brillo Cromo negro brillo	Oro satinado Oro rosa satinado Bronce satinado Cromo negro satinado Inox Spazzolato
Max 140	R80KUFRESOF			540 €	596 €	656 €	656 €	853 €	788 €
Max 180	R80KUFRESOF18			597 €	656 €	723 €	723 €	940 €	868 €

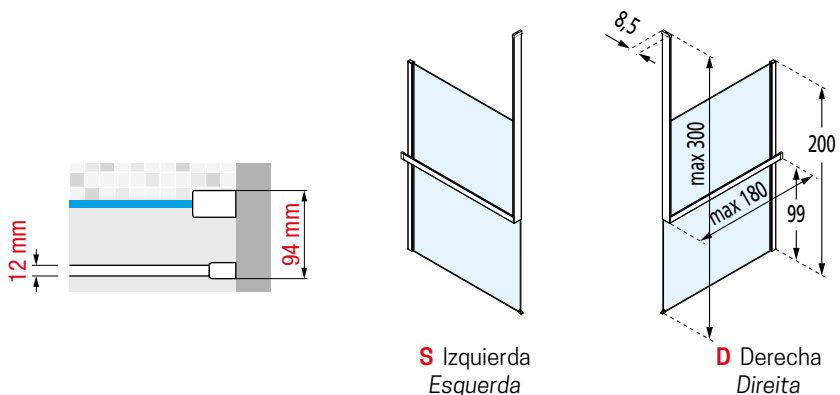



COLORES PERFILES / CORES PERFÍS

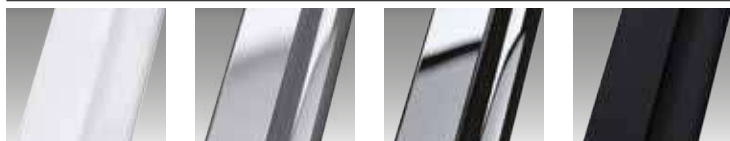

Blanco mate
Branco mate
cod. U

Silver
Abrillantado
cod. B

Cromo
cod. K

Negro mate
cod. H

COLORES PERFILES "COLORATISSIMI" / CORES PERFÍS "COLORATISSIMI"

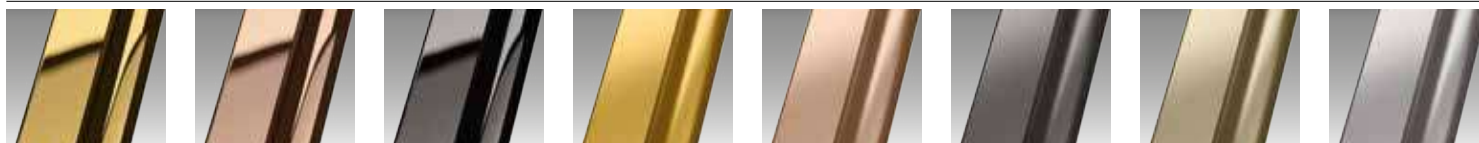

Oro brillo
cod. O

Oro rosa brillo
cod. M

Cromo negro
brillo
cod. L

Oro satinado
cod. P

Oro rosa
satinado
cod. R

Cromo negro
satinado
cod. N

Bronce satinado
cod. Q

Inox
satinado
cod. Z

KUADRA H KIT FRAME

VERSIÓN BARRA INTERNA FRAME + REPISA PORTA OBJETOS

PRECIO REFERIDO AL KIT FRAME. PEDIR CONJUNTAMENTE CON FIJO KUADRA H HASTA UNA ANCHURA MÁXIMA DE 165 CM

Código	instalación		Selección de color / precio Seleção de cores de acabados / Preço			
	Derecha Direita	Izquierda Esquerda	U	B	H	P R Q N Z
	D-	S-				
			Blanco mate Branco mate	Silver Abrillantado	Negro mate	Oro satinado Oro rosa satinado Bronce satinado Cromo negro satinado Inox satinado
R80KUFRI10			567 €	629 €	697 €	837 €

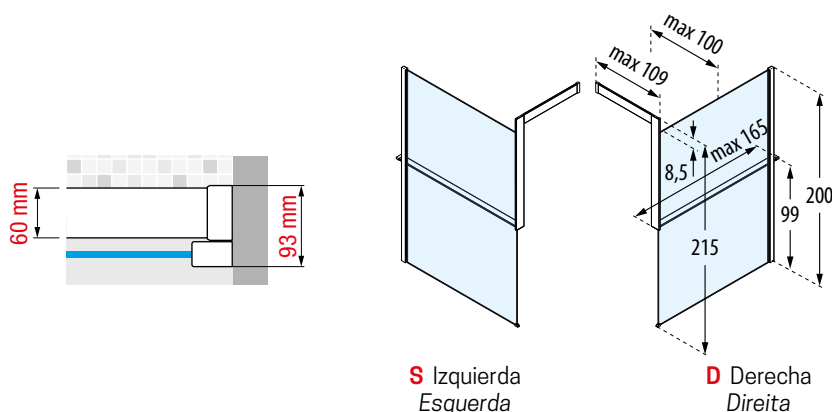

VERSIÓN BARRA INTERNA FRAME A TECHO + REPISA PORTA OBJETOS

Código	instalación		Selección de color / precio Seleção de cores de acabados / Preço			
	Derecha Direita	Izquierda Esquerda	U	B	H	P R Q N Z
	D-	S-				
			Blanco mate Branco mate	Silver Abrillantado	Negro mate	Oro satinado Oro rosa satinado Bronce satinado Cromo negro satinado Inox satinado
R80KUFRI10			498 €	554 €	615 €	738 €

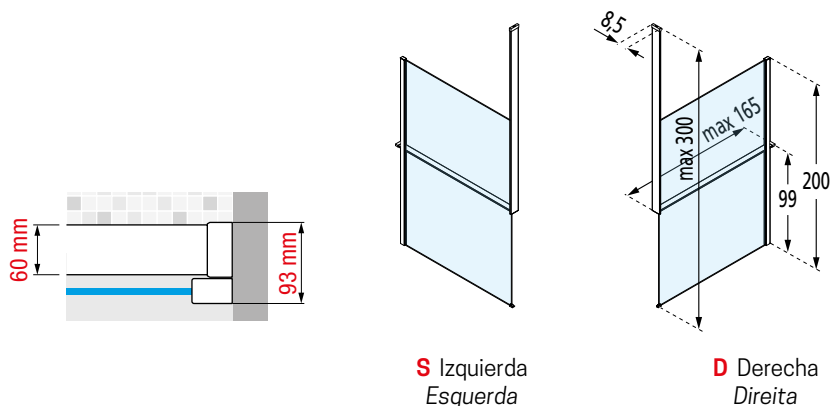



COLORES PERFILES / CORES PERFÍS



Blanco mate
Branco mate
cod. U



Silver
Abrillantado
cod. B

COLORES PERFILES "COLORATISSIMI" / CORES PERFÍS "COLORATISSIMI"

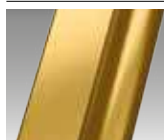

Oro satinado
cod. P



Oro rosa
satinado
cod. R

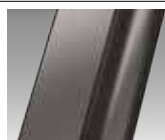

Cromo negro
satinado
cod. N

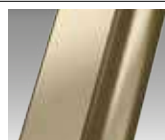

Bronce satinado
cod. Q

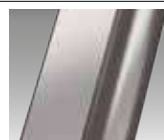

Inox
satinado
cod. Z

KUADRA HF FRAME

CON TOALLERO

PANEL FIJO INCLUIDO EN EL PRECIO



Medidas	Código	Selección Cristales Seleção Vidros	Selección de perfiles Seleção de perfis						
			U	B	K	H	O M L	P R Q N Z	
Medidas extensibilidad Medidas extensibilidade		1							
A		Transparente	Blanco mate Branco mate	Silver Abrillatado	Cromo	Negro mate	Oro brillo Oro rosa brillo Cromo negro brillo	Oro satinado Oro rosa satinado Bronce satinado Cromo negro satinado Inox satinado	
114	KUADFC116PS-		1.312 €	1.445 €	1.610 €	1.610 €	2.094 €	1.932 €	
134	KUADFC136PS-		1.385 €	1.524 €	1.696 €	1.696 €	2.205 €	2.035 €	
154	KUADFC156PS-		1.445 €	1.590 €	1.769 €	1.769 €	2.300 €	2.123 €	

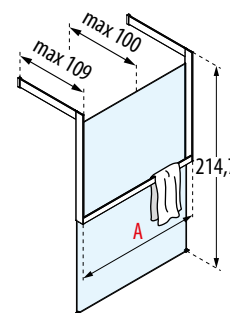

CON REPISA PORTA OBJETOS



Medidas	Código	Selección Cristales Seleção Vidros	Selección de perfiles Seleção de perfis			
			U	B	H	P R Q N Z
Medidas extensibilidad Medidas extensibilidade		1				
A		Transparente	Blanco mate Branco mate	Silver Abrillatado	Negro mate	Oro satinado Oro rosa satinado Bronce satinado Cromo negro satinado Inox satinado
114	KUADFC116PO-		1.272 €	1.405 €	1.564 €	1.876 €
134	KUADFC136PO-		1.345 €	1.484 €	1.650 €	1.981 €
154	KUADFC156PO-		1.405 €	1.551 €	1.723 €	2.067 €

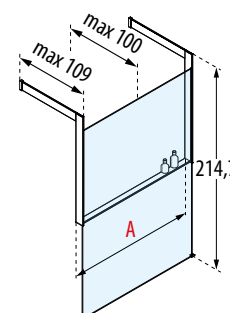



La combinación entre acabados, funciones y formas, tiene su máxima expresión en la colección **FRAME** by NOVELLINI. Los elementos en aluminio se unen con el cristal y los accesorios de ducha en un trío perfecto.

CRISTAL TEMPLADO/ VIDRO TEMPERADO



Trasparente
cod. 1

COLORES PERFILES / CORES PERFÍS



Blanco Mate
Branco Mate
cod. U

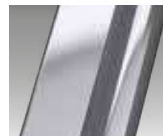

Silver
Abrillantado
cod. B



Cromo *
cod. K



Negro mate
cod. H

COLORES PERFILES "COLORATISSIMI" / CORES PERFÍS "COLORATISSIMI"



Oro brillo *
cod. O



Oro rosa brillo *
cod. M



Cromo negro
brillo *
cod. L

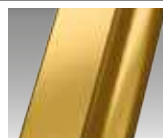

Oro satinado
cod. P



Oro rosa
satinado
cod. R

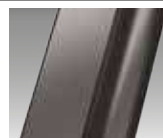

Cromo negro
satinado
cod. N

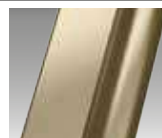

Bronce satinado
cod. Q

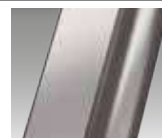

Inox
satinado
cod. Z

* solo para versiones con toallero exterior

KUADRA HN FRAME



200 cm



8 mm



3 cm



**CRISTAL TEMPLADO
VIDRO TEMPERADO**

Transparente
cod. 1

**COLORES PERFILES
CORES PERFÍS**



Blanco mate
Branco mate
cod. U

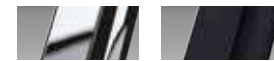

Silver
Abrillantado
cod. B



Cromo
cod. K



Negro mate
cod. H



Oro brillo
cod. O

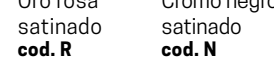

Oro rosa brillo
cod. M

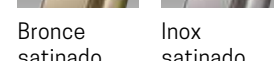

Cromo negro brillo
cod. L

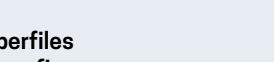

Oro satinado
cod. P



Oro rosa satinado
cod. R



Cromo negro satinado
cod. N



Bronce satinado
cod. Q



Inox satinado
cod. Z



Medidas				Código	instalación		Selección Cristales Seleção Vidros	Selección de perfiles Seleção de perfis							
Medidas extensibilidad Medidas extensibilidade	Medida fijo frontal	Entrada	Medidas del plato		Derecha Direita	Izquierda Esquerda		U	B	K	H	O M L	P R Q N Z		
A	F	*					Transparente	Blanco mate Branco mate	Silver Abrillantado	Cromo	Negro mate	Oro brillo Oro rosa brillo Cromo negro brillo	Oro satinado Oro rosa satinado Bronce satinado Cromo negro satinado Inox satinado		
117↔120	57	63	120	KUADHN120	D-	S-		683 €	756 €	842 €	842 €	1.095 €	1.010 €		
137↔140	77	63	140	KUADHN140	D-	S-		729 €	809 €	901 €	901 €	1.171 €	1.081 €		
147↔150	87	63	150	KUADHN150	D-	S-		742 €	822 €	915 €	915 €	1.189 €	1.098 €		
157↔160	97	63	160	KUADHN160	D-	S-		756 €	835 €	928 €	928 €	1.206 €	1.113 €		
167↔170	107	63	170	KUADHN170	D-	S-		802 €	888 €	988 €	988 €	1.285 €	1.186 €		
177↔180	117	63	180	KUADHN180	D-	S-		815 €	901 €	1.007 €	1.007 €	1.309 €	1.208 €		

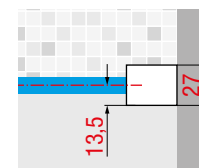
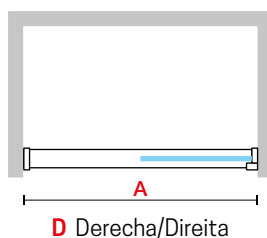
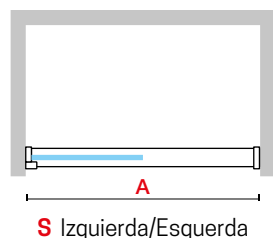
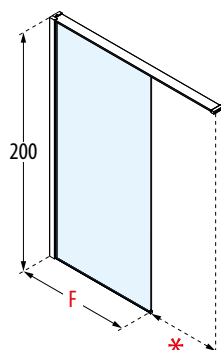

OPCIONAL

KUADRA H FRAME TOALLERO

TOALLERO EXTERIOR INSTALABLE SOLO CON PLATO ENRASADO



Medidas Medidas extensibilidad Medidas extensibilidade	Código	instalación		Selección de perfiles Seleção de perfis			
		Derecha Direita	Izquierda Esquerda	U	B	K	H
A		D-	S-	Blanco mate Branco mate	Silver Abrillantado	Cromo	Negro mate
117	R90AKFBPS	D-	S-	312 €	338 €	371 €	371 €
157	R90AKFBPS16	D-	S-	345 €	378 €	411 €	411 €

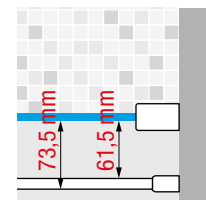
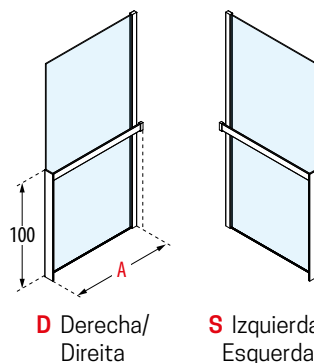

FRAME COLLECTION

OPCIONAL

KUADRA H FRAME REPISA PORTA OBJETOS

REPISA PORTA OBJETOS



Medidas Medidas extensibilidad Medidas extensibilidade	Código	instalación		Selección de perfiles Seleção de perfis		
		Derecha Direita	Izquierda Esquerda	U	B	H
A		D-	S-	Blanco mate Branco mate	Silver Abrillantado	Negro mate
117	R90AKFBPO	D-	S-	312 €	338 €	371 €
157	R90AKFBPO16	D-	S-	345 €	378 €	411 €

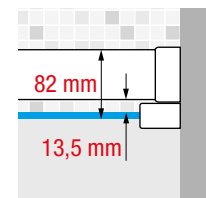
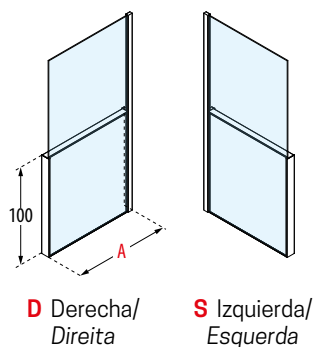

Detalle del sistema de apoyo para plato de ducha con relieve. Disponible en blanco y en negro



Construcción del código: **Código** + **Derecha/Direita** + **Perfiles Perfis** = Código completo del producto
 Construção do código: **Código** + **Izquierda/Esquerda** + **Perfis** = Código completo do produto

OPTIONAL

KUADRA HD FRAME

FRAME KIT BARRA TOALLERO EXTERIOR + REPISA INTERIOR

PRECIO REFERIDO AL KIT FRAME. PEDIR CONJUNTAMENTE CON FIJO KUADRA H



COLORES PERFILES CORES PERFÍS



Blanco mate
Branco mate
cod. U



Silver
Abrillantado
cod. B



Negro mate
cod. H

COLORATISSIMI



Oro satinado
cod. P



Oro rosa satinado
cod. R



Cromo negro satinado
cod. N



Bronce satinado
cod. Q



Inox satinado
cod. Z

Medidas	Código	instalación		Selección de color / precio Seleção de cores de acabados / Preço			
		Derecha Direita	Izquierda Esquerda	U	B	H	P R Q N Z
		D-	S-	Blanco mate Branco mate	Silver Abrillantado	Negro mate	Oro satinado Oro rosa satinado Bronce satinado Cromo negro satinado Inox satinado
Para paredes de hasta 120	R80KUFRHD12			376 €	376 €	413 €	541 €
Para paredes de 130 a 180	R80KUFRHD18			414 €	414 €	455 €	603 €

INSTALACIÓN SIN BARRA DE SOPORTE HASTA 120 CM MÁX.
INSTALAÇÃO SEM BARRA DE SUPORTE ATÉ UM MÁXIMO DE 120 CM

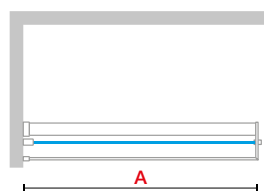
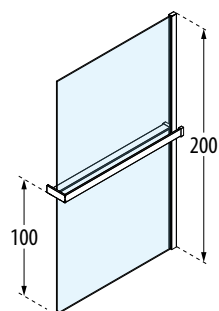

S Izquierda/Esquerda

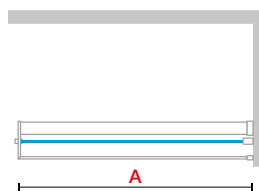

D Derecha/Direita



KUADRA HWL FRAME

2 REPISAS PORTA OBJETOS INTERIORES



200 cm



8 mm



3 cm



CRISTAL TEMPLADO VIDRO TEMPERADO



Transparente
cod. 1

COLORES PERFILES CORES PERFIS



Blanco Mate
Branco Mate
cod. U



Silver
Abrilantado
cod. B



Negro mate
cod. H



Medidas		Código	instalación		Selección Cristales Seleção Vidros	Selección de perfiles Seleção de perfis			
Medidas extensibilidad	Medidas del plato		Derecha Direita	Izquierda Esquerda		1	U	B	H
Medidas extensibilidad	Medidas del plato		D-	S-		1	U	B	H
A	AxB *± 2 mm				Transparente	Blanco mate Branco mate	Silver Abrilantado	Negro mate	
135↔138	140	KUADHWLP00140	D-	S-		1.868 €	2.054 €	2.260 €	
145↔148	150	KUADHWLP00150	D-	S-		1.891 €	2.081 €	2.289 €	
155↔158	160	KUADHWLP00160	D-	S-		1.939 €	2.134 €	2.347 €	
165↔168	170	KUADHWLP00170	D-	S-		1.963 €	2.160 €	2.377 €	
175↔178	180	KUADHWLP00180	D-	S-		1.988 €	2.187 €	2.405 €	
195↔198	200	KUADHWLP00200	D-	S-		2.012 €	2.213 €	2.435 €	
215↔218	220	KUADHWLP00220	D-	S-		2.048 €	2.253 €	2.478 €	

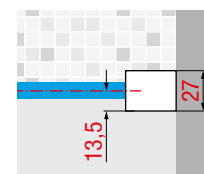
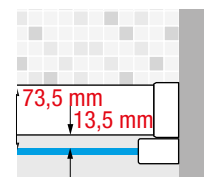
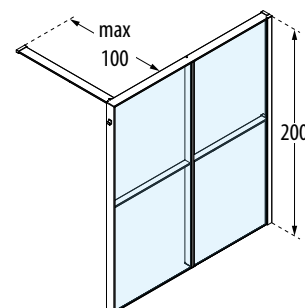

Detalle del sistema de apoyo para plato de ducha con relieve. Disponible en blanco y en negro

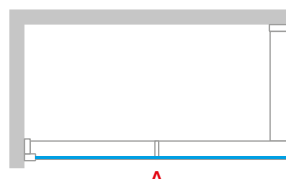

S Izquierda/Esquerda

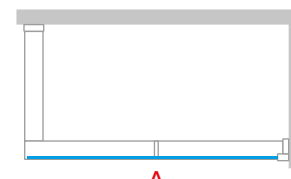

D Derecha/Direita

KUADRA HWZ1 FRAME



1 REPISA PORTA OBJETOS INTERIOR + 1 TOALLERO EXTERIOR AL LADO DE LA PARED.

PARA INSTALACIONES A RAS DE SUELO



CRISTAL TEMPLADO VIDRO TEMPERADO

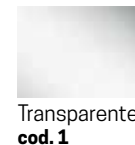

Transparente
cod. 1

COLORES PERFILES CORES PERFÍS



Blanco Mate
Branco Mate
cod. U



Silver
Abrillantado
cod. B



Negro mate
cod. H



Medidas	Código	instalación		Selección Cristales Seleção Vidros	Selección de perfiles Seleção de perfis		
		Derecha Direita	Izquierda Esquerda		1	U	B

A

Transparente

Blanco mate
Branco mate

Silver
Abrillantado

Negro mate

REPISA PORTAOBJETOS AL LADO DE LA ENTRADA

134↔137	KUADHWZPOS140	D-	S-		1.891 €	2.081 €	2.289 €
144↔147	KUADHWZPOS150	D-	S-		1.915 €	2.107 €	2.318 €
154↔157	KUADHWZPOS160	D-	S-		1.963 €	2.160 €	2.377 €
164↔167	KUADHWZPOS170	D-	S-		1.988 €	2.187 €	2.405 €
174↔177	KUADHWZPOS180	D-	S-		2.012 €	2.213 €	2.435 €
194↔197	KUADHWZPOS200	D-	S-		2.035 €	2.240 €	2.463 €
214↔217	KUADHWZPOS220	D-	S-		2.071 €	2.279 €	2.507 €

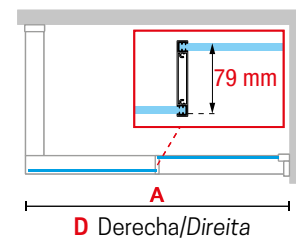
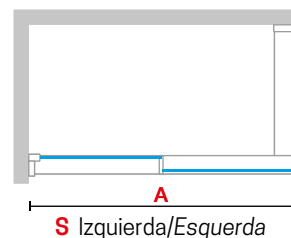
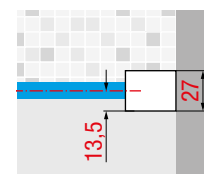
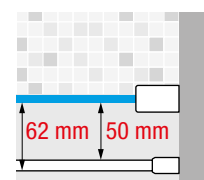
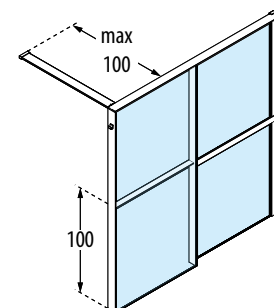

KUADRA HWZ2 FRAME



200 cm



8 mm



3 cm



1 REPISA PORTA OBJETOS INTERIOR + 1 TOALLERO EXTERIOR AL LADO DE LA ENTRADA

PARA INSTALACIONES A RAS DE SUELO



CRISTAL TEMPLADO VIDRO TEMPERADO



Transparente
cod. 1

COLORES PERFILES CORES PERFIS



Blanco Mate
Branco Mate
cod. U



Silver
Abrillantado
cod. B



Negro mate
cod. H



Medidas	Código	instalación		Selección Cristales Seleção Vidros	Selección de perfiles Seleção de perfis		
		Derecha Direita	Izquierda Esquerda		1	U	B
Medidas extensibilidad Medidas extensibilidade		D-	S-	1	U	B	H
A				Transparente	Blanco mate Branco mate	Silver Abrillantado	Negro mate

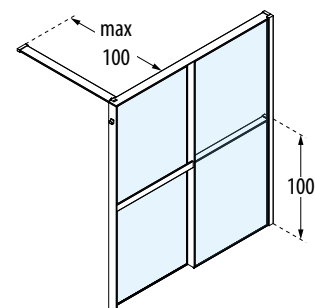

TOALLERO AL LADO DE LA ENTRADA

134↔137	KUADHWZPS0140	D-	S-		1.891 €	2.081 €	2.289 €
144↔147	KUADHWZPS0150	D-	S-		1.915 €	2.107 €	2.318 €
154↔157	KUADHWZPS0160	D-	S-		1.963 €	2.160 €	2.377 €
164↔167	KUADHWZPS0170	D-	S-		1.988 €	2.187 €	2.405 €
174↔177	KUADHWZPS0180	D-	S-		2.012 €	2.213 €	2.435 €
194↔197	KUADHWZPS0200	D-	S-		2.035 €	2.240 €	2.463 €
214↔217	KUADHWZPS0220	D-	S-		2.071 €	2.279 €	2.507 €

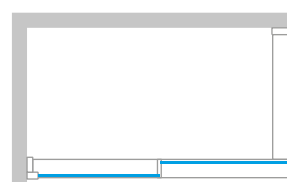
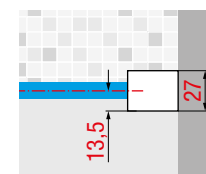
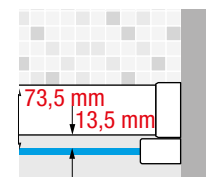

S Izquierda/Esquerda

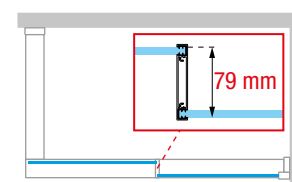

D Derecha/Direita

Construcción del código:
Construção do código:

Código

+

Derecha/Direita
Izquierda/Esquerda

+

Cristales
Vidros

+

Perfiles
Perfis

=

Código completo del producto
Código completo do produto

KUADRA HWS CON TOALLERO



PANEL FIJO CON TOALLERO EXTERIOR.
PARA INSTALACIONES A RAS DE SUELO



CRISTAL TEMPLADO VIDRO TEMPERADO



Transparente
cod. 1

COLORES PERFILES CORES PERFÍS



Blanco Mate
Branco Mate
cod. U

Silver
Abrillantado
cod. B



Negro mate
cod. H

Medidas	Código	instalación		Selección Cristales Seleção Vidros	Selección de perfiles Seleção de perfis		
		Derecha Direita	Izquierda Esquerda		1	U	B
Medidas extensibilidad Medidas extensibilidade				Transparente	Blanco mate Branco mate	Silver Abrillantado	Negro mate
A							
77↔80	KUADHWSPS80	D-	S-		1.197 €	1.302 €	1.428 €
87↔90	KUADHWSPS90	D-	S-		1.197 €	1.302 €	1.428 €
97↔100	KUADHWSPS100	D-	S-		1.197 €	1.302 €	1.428 €
107↔110	KUADHWSPS110	D-	S-		1.260 €	1.372 €	1.503 €
117↔120	KUADHWSPS120	D-	S-		1.274 €	1.385 €	1.518 €
127↔130	KUADHWSPS130	D-	S-		1.350 €	1.462 €	1.594 €
137↔140	KUADHWSPS140	D-	S-		1.350 €	1.462 €	1.594 €

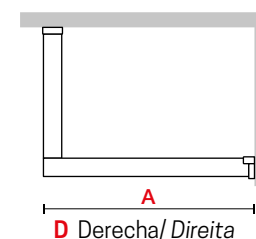
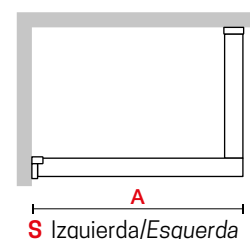
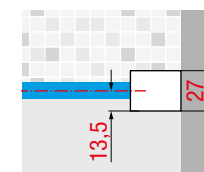
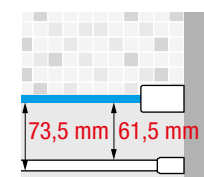
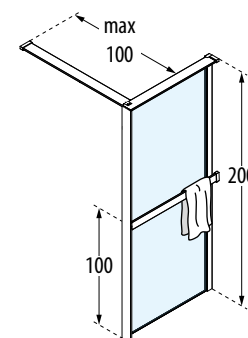

KUADRA HWS CON REPISA PORTA OBJETOS



200 cm



8 mm



3 cm

PANEL FIJO CON REPISA PORTAOBJETOS INTERIOR



CRISTAL TEMPLADO VIDRO TEMPERADO



Transparente
cod. 1

COLORES PERFILES CORES PERFIS



Blanco Mate
Branco Mate
cod. U



Silver
Abrillantado
cod. B



Negro mate
cod. H

Medidas	Código	instalación		Selección Cristales Seleção Vidros	Selección de perfiles Seleção de perfis		
		Derecha Direita	Izquierda Esquerda		U	B	H
A		D-	S-	1	U	B	H
				Transparente	Blanco mate Branco mate	Silver Abrillantado	Negro mate
77↔80	KUADHWSP080	D-	S-		1.197 €	1.302 €	1.428 €
87↔90	KUADHWSP090	D-	S-		1.197 €	1.302 €	1.428 €
97↔100	KUADHWSP0100	D-	S-		1.197 €	1.302 €	1.428 €
107↔110	KUADHWSP0110	D-	S-		1.260 €	1.372 €	1.503 €
117↔120	KUADHWSP0120	D-	S-		1.274 €	1.385 €	1.518 €
127↔130	KUADHWSP0130	D-	S-		1.350 €	1.462 €	1.594 €
137↔140	KUADHWSP0140	D-	S-		1.350 €	1.462 €	1.594 €

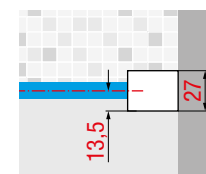
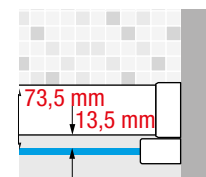
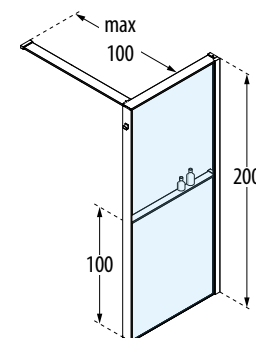

Detalle del sistema de apoyo para plato de ducha con relieve. Disponible en blanco y en negro

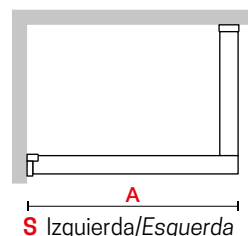

S Izquierda/Esquerda

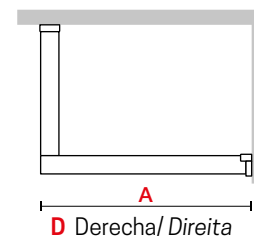

D Derecha/Direita

Construcción del código: Código + Derecha/Direita + Cristales + Perfiles = Código completo del producto
 Construção do código: Código + Izquierda/Esquerda + Vidros + Perfis = Código completo do produto

KUADRA H IN-ART

PANEL FIJO
PAINEL FIXO



200 cm



8 mm



3 cm



COLORES PERFILES CORES PERFÍS



Blanco mate
Branco mate
cod U



Silver
Abrillantado
cod B



Cromo
cod K



Negro mate
cod H



Inox
cod Z

Medidas	Código	Derecha Direita	Izquierda Esquerda	selección de imagen selecção imagem	Selección de perfiles Selecção de perfis				
Medidas extensibilidad Medidas extensibilidade		D-	S-	*	U	B	K	H	Z
A					Blanco mate Branco mate	Silver Abrillantado	Cromo	Negro mate	Inox
67↔70	KUADH70			Códigos imagen de pag. 183 a 185 Códigos imagem da pag. 183 a 185	1.200 €	1.253 €	1.312 €	1312	1477
72↔75	KUADH75				1.200 €	1.253 €	1.312 €	1312	1477
77↔80	KUADH80				1.272 €	1.325 €	1.385 €	1385	1550
87↔90	KUADH90				1.378 €	1.431 €	1.491 €	1491	1656
97↔100	KUADH100				1.378 €	1.431 €	1.491 €	1491	1656
107↔110	KUADH110				1.438 €	1.498 €	1.564 €	1564	1728
117↔120	KUADH120				1.544 €	1.604 €	1.670 €	1670	1834
127↔130	KUADH130				1.617 €	1.677 €	1.743 €	1743	1907
137↔140	KUADH140				1.617 €	1.677 €	1.743 €	1743	1907

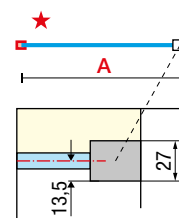
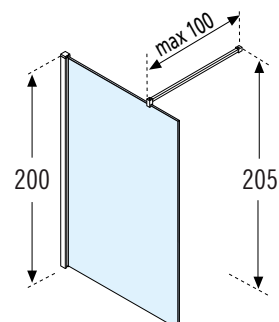

BARRA DE SUJECIÓN DE 100 CM. INCLUIDA
LA BARRA DE SUJECIÓN DE 150 CM. ES OPCIONAL (VER PÁG. 308)
A BARRA DE SUJEIÇÃO DE 150 CM. É OPCIONAL (VER PAG. 308)

In Art es un producto realizado hecho en polvo de vidrio por lo que la definición no es fotográfica y puede estar sujeta a pequeñas variaciones de color y resolución.

- No disponible en medidas especiales

- Bajo pedido y confirmación del departamento técnico, es posible crear imágenes personalizadas solo en artículos de tamaño estándar. Incremento sobre cristal transparente +500 euros.

Pieza de sujección del cristal a suelo
Peça de fixação do vidro ao chão

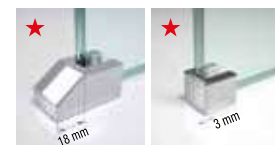

KUADRA FC IN-ART

PANEL FIJO A UNA SOLA PARED
PAINEL FIXO CENTRO PAREDE



COLORES PERFILES CORES PERFÍS



Blanco mate
Branco mate
cod U

Silver
Abrillantado
cod B



Cromo
cod K

Negro mate
cod H



Inox
cod Z



Medidas	Código	selección de imagen selecção imagem	Selección de perfiles Selecção de perfis				
			U	B	K	H	Z
Medidas extensibilidad Medidas extensibilidade		*					
C			Blanco mate Branco mate	Silver Abrillantado	Cromo	Negro mate	Inox
94	KUADFC96-	Códigos	1.438 €	1.498 €	1.564 €	1.564 €	1.728 €
114	KUADFC116-	imagen de pag. 183 a 185	1.571 €	1.630 €	1.696 €	1.696 €	1.860 €
134	KUADFC136-	Códigos imagem da pag. 183 a 185	1.624 €	1.683 €	1.749 €	1.749 €	1.913 €
154	KUADFC156-		1.663 €	1.730 €	1.802 €	1.802 €	1.966 €

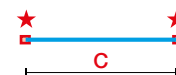
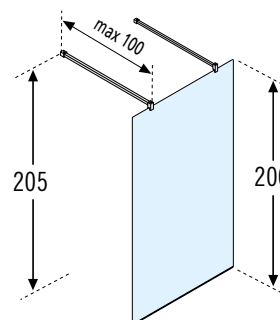

LA BARRA DE SUJECCIÓN DE 150 CM. ES OPCIONAL (VER PÁG. 308)
A BARRA DE SUJEIÇÃO DE 150 CM.É OPCIONAL (VER PAG. 308)

In Art es un producto realizado hecho en polvo de vidrio por lo que la definición no es fotográfica y puede estar sujeta a pequeñas variaciones de color y resolución.
- No disponible en medidas especiales
- Bajo pedido y confirmación del departamento técnico, es posible crear imágenes personalizadas solo en artículos de tamaño estándar. Incremento sobre cristal transparente +500 euros.

Pieza de sujeción del cristal a suelo
Peça de fixação do vidro ao chão



Construcción del código: Código + Cristales Vidros + Perfiles Perfis = Código completo del producto
Construção do código

KUADRA HL

PANEL FIJO
PAINEL FIXO



200 cm

8 mm



CRISTAL TEMPLADO VIDRO TEMPERADO



Transparente
cod 1

COLORES PERFILES / CORES PERFÍS



Blanco mate
Branco mate
cod A



Silver
Abrillantado
cod B



Cromo
cod K



Negro mate
cod H



Inox
cod Z

Medidas	Código	Selección Cristales Seleção Vidros	Selección de perfiles Seleção de perfís				
Medidas extensibilidad Medidas extensibilidade		1	U	B	K	H	Z

FIJO / FIXO

D		Transparente	Blanco mate Branco mate	Silver Abrillantado	Cromo	Negro mate	Inox
68	KUADHL70-		438 €	484 €	544 €	544 €	708 €
78	KUADHL80-		464 €	511 €	570 €	570 €	735 €
88	KUADHL90-		491 €	537 €	597 €	597 €	761 €
98	KUADHL100-		517 €	564 €	623 €	623 €	788 €
118	KUADHL120-		544 €	590 €	650 €	650 €	814 €
138	KUADHL140-		570 €	617 €	676 €	676 €	841 €
158	KUADHL160-		597 €	643 €	703 €	703 €	867 €

KUADRA HL

F							
15	KUADHL15-		186 €	206 €	226 €	226 €	270 €
30	KUADHL30-		206 €	226 €	246 €	246 €	295 €
40	KUADHL40-		232 €	252 €	272 €	272 €	326 €

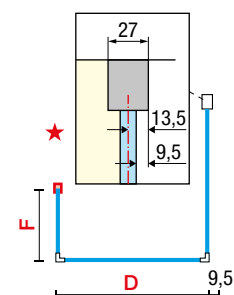
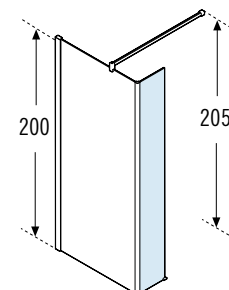
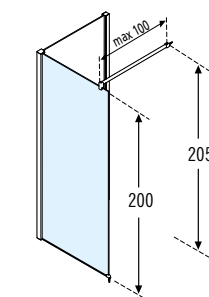

Pieza de sujeción
del cristal a suelo
Peça de fixação
do vidro ao chão

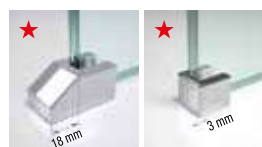

LA BARRA DE SUJECCIÓN DE 150 CM. ES OPCIONAL (VER PÁG. 308)
A BARRA DE SUJEIÇÃO DE 150 CM. É OPCIONAL (VER PAG. 308)



KUADRA H IN ART / SELECCIÓN DE DECORADOS / SELEÇÃO DE DECORAÇÃO

KUADRA H IN-ART



IZQUIERDA/ESQUERDA | COD. **FH020**

DERECHA/DIREITA | COD. **FH020**



IZQUIERDA/ESQUERDA | COD. **FH030**

DERECHA/DIREITA | COD. **FH030**



IZQUIERDA/ESQUERDA | COD. **FH042**

DERECHA/DIREITA | COD. **FH041**

NO DISPONIBLE PARA MEDIDA 70 - 75



IZQUIERDA/ESQUERDA | COD. **FH052**

DERECHA/DIREITA | COD. **FH051**

NO DISPONIBLE PARA MEDIDA 70 - 75



IZQUIERDA/ESQUERDA | COD. **GH020**

DERECHA/DIREITA | COD. **GH020**

NO DISPONIBLE PARA MEDIDA 70 - 75



IZQUIERDA/ESQUERDA | COD. **GH052**

DERECHA/DIREITA | COD. **GH051**

NO DISPONIBLE PARA MEDIDA 70 - 75



IZQUIERDA/ESQUERDA | COD. **GH062**

DERECHA/DIREITA | COD. **GH061**



IZQUIERDA/ESQUERDA | COD. **GH072**

DERECHA/DIREITA | COD. **GH071**

NO DISPONIBLE PARA MEDIDA 70 - 75 - 80

KUADRA H IN ART / SELECCIÓN DE DECORADOS / SELEÇÃO DE DECORAÇÃO

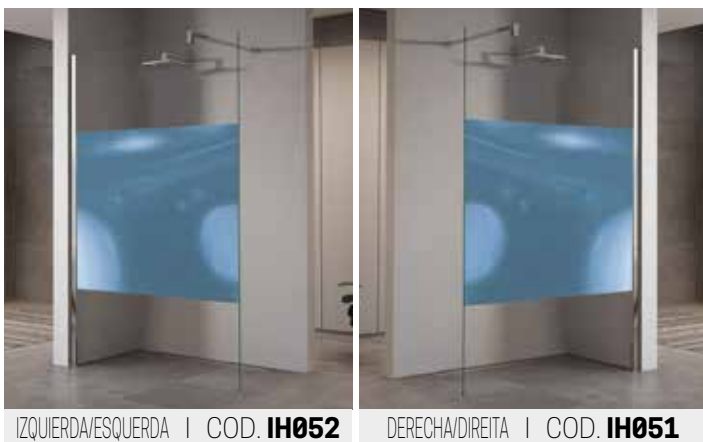

NO DISPONIBLE PARA MEDIDA 70 - 75 - 80



IZQUIERDA/ESQUERDA | COD. **T0301**



DERECHA/DIREITA | COD. **TS301**



IZQUIERDA/ESQUERDA | COD. **R0091**



DERECHA/DIREITA | COD. **RS091**



IZQUIERDA/ESQUERDA | COD. **RS101**



DERECHA/DIREITA | COD. **R0101**

NO DISPONIBLE PARA MEDIDA 70 - 75 - 80



IZQUIERDA/ESQUERDA | COD. **T0431**



DERECHA/DIREITA | COD. **T0431**

NO DISPONIBLE PARA MEDIDA 70 - 75 - 80 - 90 - 100



IZQUIERDA/ESQUERDA | COD. **TS271**



DERECHA/DIREITA | COD. **T0271**

NO DISPONIBLE PARA MEDIDA 70 - 75



IZQUIERDA/ESQUERDA | COD. **T0331**



DERECHA/DIREITA | COD. **T0331**



IZQUIERDA/ESQUERDA | COD. **A0051**



DERECHA/DIREITA | COD. **A0051**



GIADA H EDGE



◀ Amplia gama de accesorios para fijar al perfil
Vasta gama de acessórios para fixar ao perfil



◀ barra estabilizadora opcional
Barra de suporte opcional



◀ Barra-toallero exterior opcional
Toalheiro opcional

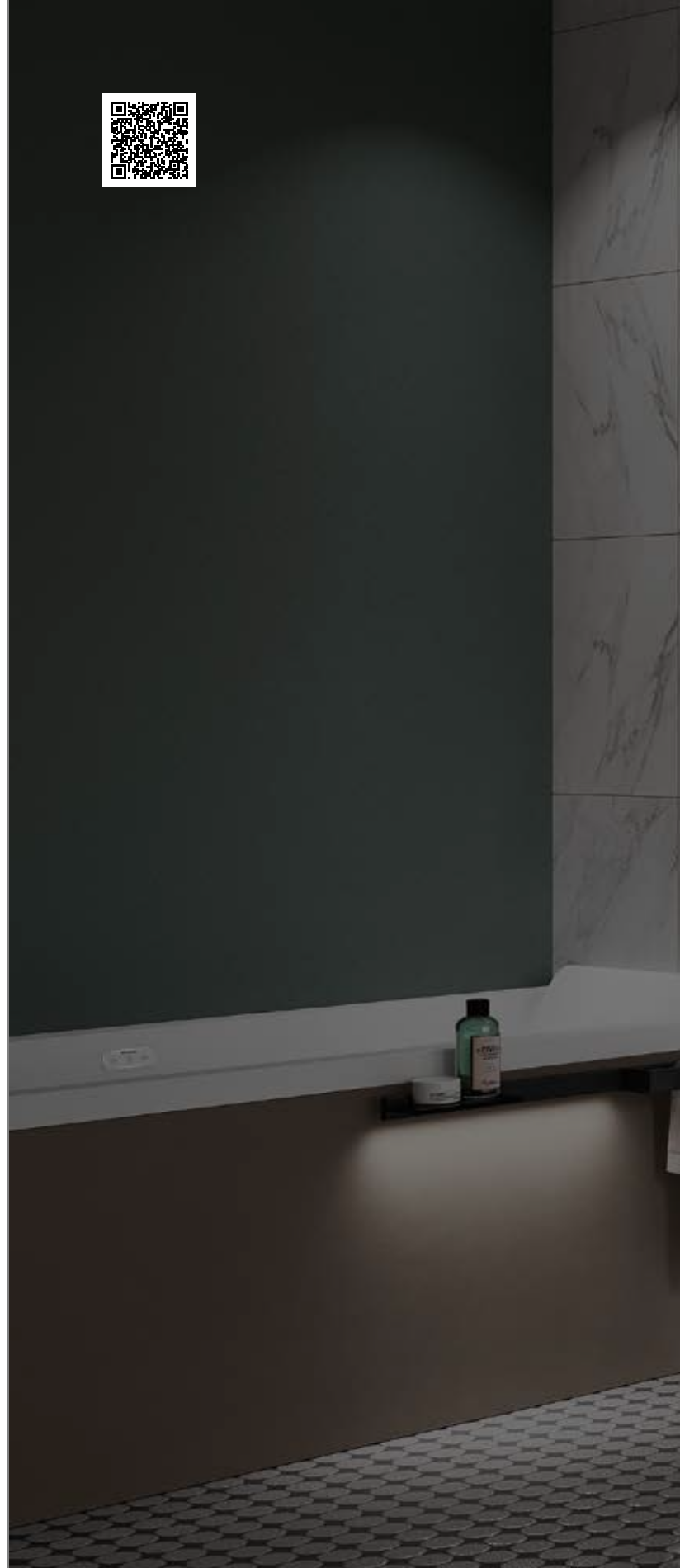

TRATTAMENTI





EDGE COLLECTION

GIADA H EDGE

GIADA H

PANEL FIJO
PAINEL FIXO



195 cm



6 mm



1,5 cm



CRISTAL TEMPLADO VIDRO TEMPERADO



Transparente
cod. 1



Banda satin
cod. 44

COLORES PERFILES CORES PERFIS



Blanco Mate
Branco Mate
cod. U



Silver
Abrillantado
cod. B



Cromo
cod. K



Negro mate
cod. H

Medidas	Código	Selección Cristales Seleção Vidros		Selección de perfiles Seleção de perfis			
		1	44	A	B	K	H
Medidas extensibilidad Medidas extensibilidade							
A		Transparente	banda satinada	Blanco Branco	Silver Abrillantado	Cromo	Negro mate
27↔28,5	GIADAH30-			325 €	358 €	398 €	398 €
37↔38,5	GIADAH40-			391 €	431 €	477 €	477 €
47↔48,5	GIADAH50-			451 €	497 €	550 €	550 €
57↔58,5	GIADAH60-			514 €	569 €	630 €	630 €
67↔68,5	GIADAH70-			528 €	582 €	643 €	643 €
72↔73,5	GIADAH75-			541 €	596 €	656 €	656 €
77↔78,5	GIADAH80-			555 €	608 €	670 €	670 €
87↔88,5	GIADAH90-			569 €	623 €	684 €	684 €
97↔98,5	GIADAH100-		+ 40 €	588 €	650 €	718 €	718 €
107↔108,5	GIADAH110-			602 €	663 €	730 €	730 €
117↔118,5	GIADAH120-			617 €	676 €	744 €	744 €
127↔128,5	GIADAH130-			630 €	691 €	758 €	758 €
137↔138,5	GIADAH140-			650 €	718 €	792 €	792 €
147↔148,5	GIADAH150-			670 €	737 €	811 €	811 €
157↔158,5	GIADAH160-			691 €	758 €	832 €	832 €
167↔168,5	GIADAH170-			723 €	795 €	875 €	875 €
177↔178,5	GIADAH180-			756 €	831 €	915 €	915 €

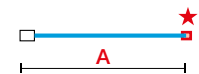
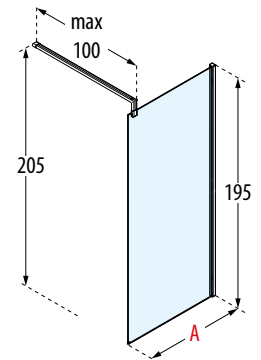

Pieza de sujeción del cristal a suelo
Peça de fixação do vidro ao chão

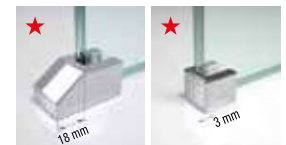

OPCIONAL

GIADA HFP1

PUERTA GIRATORIA PARA INSTALAR SOBRE PANEL FIJO



195 cm



6 mm



CRISTAL TEMPLADO VIDRO TEMPERADO



Transparente
cod. 1



Banda satin
cod. 44

COLORES PERFILES CORES PERFÍS



Blanco Mate
Branco Mate
cod. U



Silver
Abrillantado
cod. B



Cromo
cod. K



Negro mate
cod. H

Medidas	Código	Selección Cristales Seleção Vidros		Selección de perfiles Seleção de perfis			
		1	44	A	B	K	H
Medidas extensibilidad Medidas extensibilidade		Transparente	banda satinado	Blanco Branco	Silver Brillantado	Cromo	Negro mate
A	GIADAHAP37-		+ 42 €	299 €	329 €	359 €	359 €

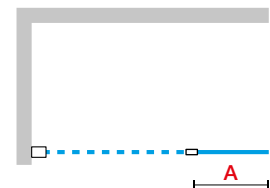
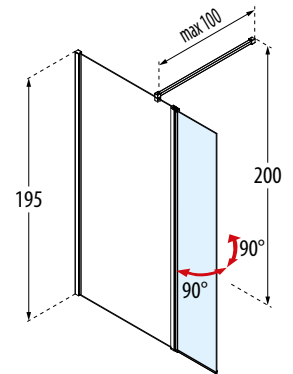

EDGE COLLECTION

OPTIONAL

GIADA HA

PUERTA GIRATORIA PARA INSTALAR SOBRE PANEL FIJO



CRISTAL TEMPLADO VIDRO TEMPERADO

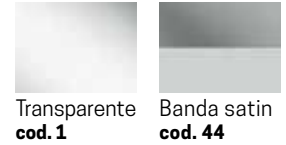

COLORES PERFILES CORES PERFÍS



Medidas	instalación	Código	Selección Cristales Seleção Vidros		Selección de perfiles Seleção de perfis		
			1	44	A	K	H
Medidas extensibilidad Medidas extensibilidade			Transparente	banda satinado	Blanco Branco	Cromo	Negro mate
A							
37		GIADAHA37-		-	212 €	212 €	212 €
	Derecha Direita	GIADAHA37D-		+ 40 €	212 €	212 €	212 €
	Izquierda Esquerda	GIADAHA37S-			212 €	212 €	212 €

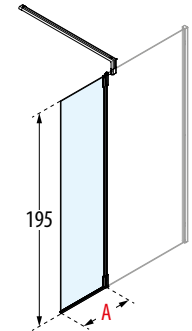

OPTIONAL

GIADA HF KIT EDGE

FIJO EN LÍNEA PARA INSTALAR SOBRE FIJO



CRISTAL TEMPLADO VIDRO TEMPERADO



Transparente
cod. 1

COLORES PERFILES CORES PERFIS



Blanco Mate
Branco Mate
cod. U



Silver
Abrilantado
cod. B



Cromo
cod. K



Negro mate
cod. H

Medidas	Código	Selección Cristales Seleção Vidros	Selección de perfiles Seleção de perfis			
Medidas extensibilidad Medidas extensibilidade		1	A	B	K	H
A		Transparente	Blanco Branco	Silver Abrilantado	Cromo	Negro mate
37	GIADAHF37-		464 €	511 €	562 €	562 €

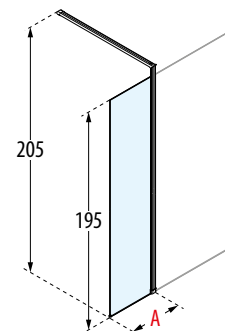

Construcción del código: **Código** + **Cristales Vidros** + **Perfiles Perfis** = Código completo del producto
 Construção do código: **Código** + **Cristales Vidros** + **Perfiles Perfis** = Código completo do produto

OPCIONAL

GIADA H+H KIT EDGE

PARA COMPONER UN GIADA H+H SELECCIONAR 3 CÓDIGOS: GIADA H + GIADA H + BARRA ESTABILIZADORA EDGE



COLORES PERFILES CORES PERFÍS



Blanco Mate
Branco Mate
cod. U



Silver
Abrillantado
cod. B



Cromo
cod. K



Negro mate
cod. H

BARRA ESTABILIZADORA EDGE PARA GIADA H+H

Medidas	Código	Selección de color / precio Seleção de cores de acabados / Preço			
		A	B	K	H
		Blanco Branco	Silver Abrillantado	Cromo	Negro mate
180	R80EDGHH180-	239 €	265 €	292 €	292 €

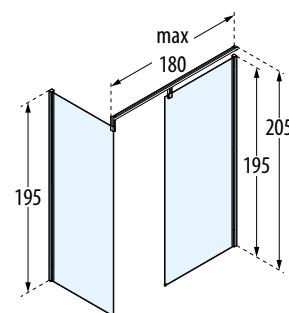

GIADA HL

PANEL FIJO
PAINEL FIXO



195 cm

6 mm



CRISTAL TEMPLADO VIDRO TEMPERADO



Transparente
cod. 1



Banda
satinada
cod. 44

COLORES PERFILES / CORES PERFIS



Blanco
Branco
cod. A



Silver
Abrillantado
cod. B



Cromo
cod. K

Medidas	Código	Selección Cristales Seleção Vidros		Selección de perfiles Seleção de perfis		
		1	44	A	B	K
Medidas extensibilidad Medidas extensibilidade						
F/D		Transparente	banda satinado	Blanco Branco	Silver Abrillantado	Cromo
15	GIADAHL15-			163 €	183 €	204 €
30	GIADAHL30-		-	183 €	204 €	225 €
40	GIADAHL40-			211 €	231 €	251 €
68	GIADAHL70-			421 €	466 €	528 €
78	GIADAHL80-			447 €	495 €	555 €
88	GIADAHL90-		+ 40 €	474 €	522 €	582 €
98	GIADAHL100-			501 €	549 €	608 €
118	GIADAHL120-			528 €	576 €	636 €

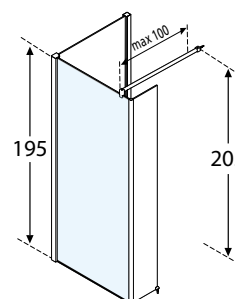
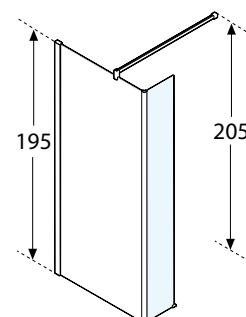

OPCIONAL



PIEZA PARA ELEVACIÓN DEL FIJO SOBRE EL PLATO DE DUCHA Ø 29 MM
PEÇA PARA ELEVAÇÃO DO FIXO SOBRE A BASE DE CHUVEIRO Ø 29 MM

Código	Precio / Preço
R05KUHL1-K	64 €

Pieza de sujeción del cristal a suelo
Peça de fixação do vidro ao chão

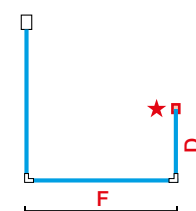
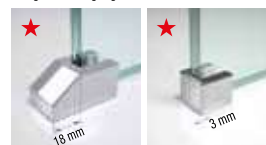

LA BARRA DE SUJECIÓN DE 150 CM. ES OPCIONAL (VER PÁG. 308)
A BARRA DE SUJEIÇÃO DE 150 CM. É OPCIONAL (VER PAG. 308)

Construcción del código: **Código** + **Cristales Vidros** + **Perfiles Perfis** = Código completo del producto
Construção do código: **Código** + **Cristales Vidros** + **Perfiles Perfis** = Código completo do produto

BARRA ESTABILIZADORA **EDGE**



BARRA ESTABILIZADORA EDGE PARA GIADA H

Medidas	Código	Selección de color / precio Seleção de cores de acabados / Preço			
		A	B	K	H
		Blanco Branco	Silver Abrillantado	Cromo	Negro mate
100	R80EDGH100-	193 €	212 €	232 €	232 €

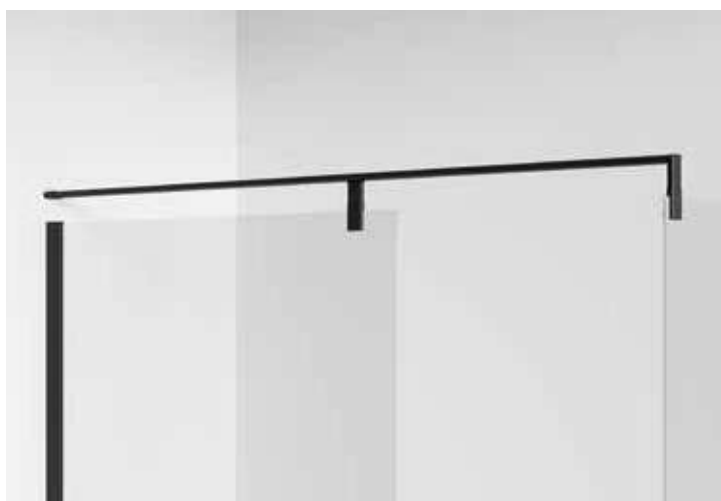

BARRA ESTABILIZADORA EDGE PARA GIADA H+H

Medidas	Código	Selección de color / precio Seleção de cores de acabados / Preço			
		A	B	K	H
		Blanco Branco	Silver Abrillantado	Cromo	Negro mate
180	R80EDGHH180-	239 €	265 €	292 €	292 €



BARRA ESPECIAL A SUELO EDGE

Código	Selección de color / precio Seleção de cores de acabados / Preço			
	A	B	K	H
	Blanco Branco	Silver Abrillantado	Cromo	Negro mate
R80EDGHPAV-	212 €	232 €	259 €	259 €

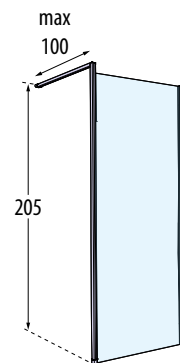

KIT PARA FIJACIÓN A TECHO DE LA BARRA DE SUJECCIÓN SUMINISTRADA KIT PARA FIXAÇÃO AO TECTO DA BARRA DE FIXAÇÃO (FORNECIDA)

Color Cores	Código	Precio / Preço
Blanco / Branco	R801SOFEL-A	42 €
Cromo	R801SOFEL-K	46 €
Negro mate	R801SOFEL-H	46 €



◀ **TOALLERO EDGE PAA GIADA H+H**

Medidas	Código	Selección de color / precio Seleção de cores de acabados / Preço			
		A	B	K	H
		Blanco Branco	Silver Abrilantado	Cromo	Negro mate
37	R90AGEBPS37VP-	166 €	186 €	206 €	206 €



◀ **BARRA-TOALLERO EXTERIOR PARA GIADA H**
FIJACIÓN DE PARED A PERFIL

Medidas	Código	Derecha Direita	Izquierda Esquerda	Selección de color / precio Seleção de cores de acabados / Preço			
				A	B	K	H
		D-	S-	Blanco Branco	Silver Abrilantado	Cromo	Negro mate
90	R90AGEBPS90PM	D-	S-	173 €	193 €	212 €	212 €
135	R90AGEBPS135PM	D-	S-	239 €	252 €	265 €	265 €
180	R90AGEBPS180PM	D-	S-	299 €	325 €	352 €	352 €

VERSIÓN IZQUIERDA / VERSÃO ESQUERDA



◀ **BARRA-TOALLERO EXTERIOR PARA GIADA H**
FIJACIÓN DE PARED A CRISTAL

Medidas	Código	Derecha Direita	Izquierda Esquerda	Selección de color / precio Seleção de cores de acabados / Preço			
				A	B	K	H
		D-	S-	Blanco Branco	Silver Abrilantado	Cromo	Negro mate
90	R90AGEBPS90VM	D-	S-	173 €	193 €	212 €	212 €
135	R90AGEBPS135VM	D-	S-	239 €	252 €	265 €	265 €
180	R90AGEBPS180VM	D-	S-	299 €	325 €	352 €	352 €

VERSIÓN IZQUIERDA / VERSÃO ESQUERDA

OPCIONES

GIADA H+HFA VERSIÓN ENTRE PAREDES / VERSÃO ENTRE PAREDES

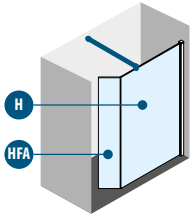

GIADA H
GIADA HFA
BARRA ESTABILIZADORA
SUMINISTRADA DE SERIE

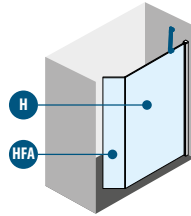

GIADA H
GIADA HFA
BARRA ORIENTABLE

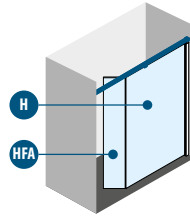

GIADA H
GIADA HFA
BARRA EVO
(entre paredes)

GIADA H+HFA VERSIÓN / VERSÃO EN ÁNGULO

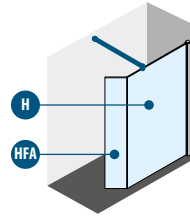

GIADA H
GIADA HFA
BARRA ESTABILIZADORA
SUMINISTRADA DE SERIE

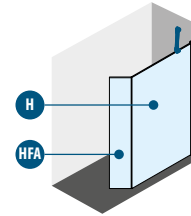

GIADA H
GIADA HFA
BARRA ORIENTABLE

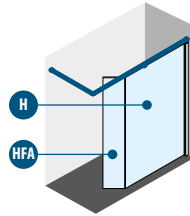

GIADA H
GIADA HFA
BARRA EVO (ángulo)

GIADA H+HFP1 VERSIÓN ENTRE PAREDES / VERSÃO ENTRE PAREDES

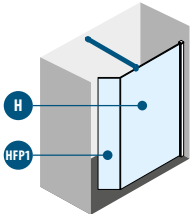

GIADA H
GIADA HFP1
BARRA ESTABILIZADORA
SUMINISTRADA DE SERIE

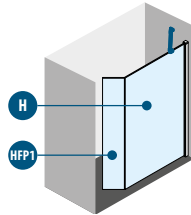

GIADA H
GIADA HFP1
BARRA ORIENTABLE

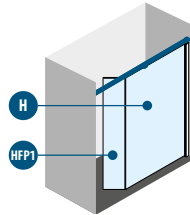

GIADA H
GIADA HFP1
BARRA EVO
(entre paredes)

GIADA H+HFP1 VERSIÓN / VERSÃO EN ÁNGULO

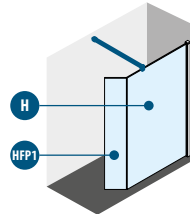

GIADA H
GIADA HFP1
BARRA ESTABILIZADORA
SUMINISTRADA DE SERIE

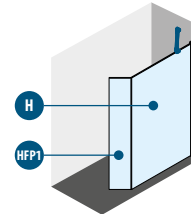

GIADA H
GIADA HFP1
BARRA ORIENTABLE

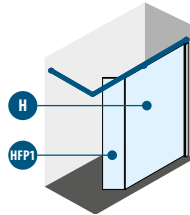

GIADA H
GIADA HFP1
BARRA EVO (ángulo)

GIADA H+H VERSIÓN / VERSÃO EN ÁNGULO

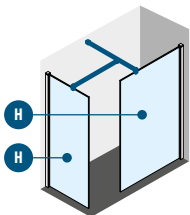

GIADA H x2
BARRA ESTABILIZADORA
SUMINISTRADA DE SERIE

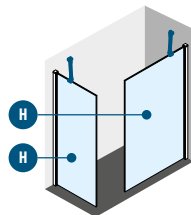

GIADA H x2
BARRA ORIENTABLE

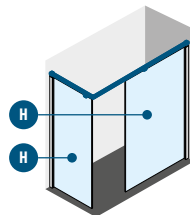

GIADA H x2
BARRA EVO (ángulo)

GIADA H6 VERSIÓN ENTRE PAREDES / VERSÃO ENTRE PAREDES

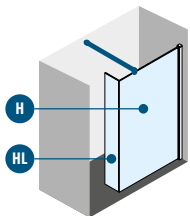

GIADA H
GIADA HL
BARRA ESTABILIZADORA
SUMINISTRADA DE SERIE

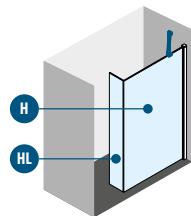

GIADA H
GIADA HL
BARRA ORIENTABLE

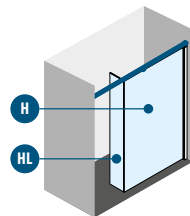

GIADA H
GIADA HL
BARRA EVO
(entre paredes)

GIADA H6 VERSIÓN / VERSÃO EN ÁNGULO

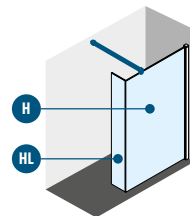

GIADA H
GIADA HL
BARRA ESTABILIZADORA
SUMINISTRADA DE SERIE

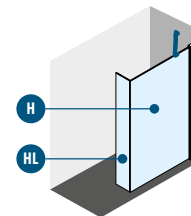

GIADA H
GIADA HL
BARRA ORIENTABLE

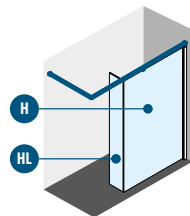

GIADA H
GIADA HL
BARRA EVO (ángulo)

GIADA H7 VERSIÓN / VERSÃO EN ÁNGULO

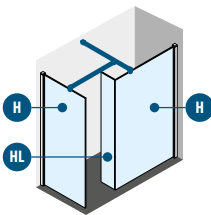

GIADA H x2
GIADA HL
BARRA ESTABILIZADORA
SUMINISTRADA DE SERIE

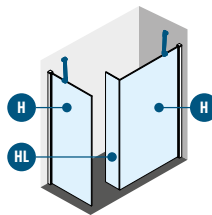

GIADA H x2
GIADA HL
BARRA ORIENTABLE x 2

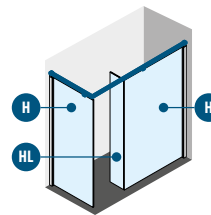

GIADA H x2
GIADA HL
BARRA EVO (ángulo)

KUADRA H9 VERSIÓN A UNA SOLA PARED / **VERSÃO CENTRO PARED**

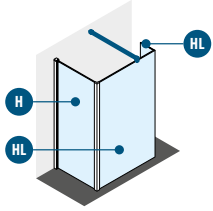

GIADA HL x2
GIADA H
BARRA ESTABILIZADORA
SUMINISTRADA DE SERIE

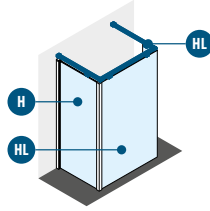

GIADA HL x2
GIADA H
BARRA EVO (en C)

GIADA H9 VERSIÓN / **VERSÃO EN ÁNGULO**

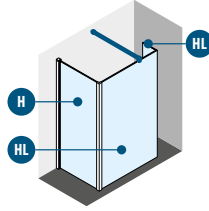

GIADA HL x2
GIADA H
BARRA ESTABILIZADORA
SUMINISTRADA DE SERIE

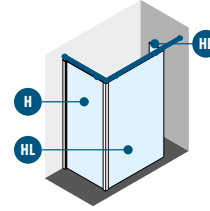

GIADA HL x2
GIADA H
BARRA EVO (ángulo)

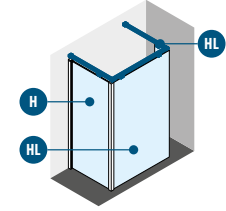

GIADA HL x2
GIADA H
BARRA EVO (en C)

DATOS TÉCNICOS / DADOS TÉCNICOS

COLORES PERFILES / CORES PERFÍS



Blanco/Cromo
Branco/Cromo
cod. A/D



Silver
Abrillantado
cod. B



Cromo
cod. K



Negro Mate
cod. H

CRISTAL / VIDRO 6 mm (European Standards UNI EN 14428)



Transparente ✦ CRYSTAL CLEAR
cod. 1

SERIGRAFIA



Banda satinada
cod. 44

BARRA ESTABILIZADORA SUMINISTRADA DE SERIE



Barra de sujeción 100 cm
Barra de fixação 100 cm

**MEDIDAS QUE OCUPAN LOS PERFILES EN LA PARED
ESPAÇO QUE OCUPAN OS PERFÍS NA PAREDE**

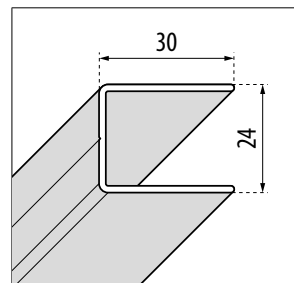

A PARED

Color/Cor	Código
Blanco/Branco	P01LGHST-A
Silver/Abrillantado	P01LGHST-B
Cromo	P01LGHST-K

PARA OTRAS OPCIONES DE BARRAS DE SUJECIÓN VER PÁG. 308

BARRAS DE SUJECIÓN PARA KUADRA H Y GIADA H

BARRA DE SUJECIÓN 150 CM

BARRA DE FIXAÇÃO 150 CM

barra de 100 cm suministrada
barra de 100 cm fornecida



Color Cores	Código	Precio Preço
Blanco Branco	R80GIANF15-A	99 €
Blanco mate Branco mate	R80GIANF15-U	99 €
Silver Brillantado	R80GIANF15-B	110 €
Cromo	R80GIANF15-K	122 €
Negro mate	R80GIANF15-H	122 €
Inox satinado	R80GIANF15-Z	146 €

KIT ESTABILIZADOR

“DOS BARRAS EN T”



Color Cores	Código	Precio Preço
Blanco Branco	R80KUORT150-D	170 €
Silver Brillantado	R80KUORT150-B	182 €
Cromo	R80KUORT150-K	194 €
Negro mate	R80KUORT150-H	194 €

- 2 barras de 150 cms ajustables a medida
- 1 pieza de fijación a pared
- 2 piezas de fijación al cristal
- 1 pieza de unión entre barras

BARRA ESTABILIZADORA

BARRA ESTABILIZADORA



Color Cores	Medidas	Código	Precio Preço
Blanco mate Branco mate	25 cm	R80LOU250-U	76 €
Cromo		R80LOU250-K	76 €
Negro mate		R80LOU250-H	76 €
Inox satinado	35 cm	R80LOU250-Z	92 €
Blanco mate Branco mate		R80LOU350-U	83 €
Cromo		R80LOU350-K	83 €
Negro mate	45 cm	R80LOU350-H	83 €
Inox satinado		R80LOU350-Z	100 €
Blanco mate Branco mate		R80LOU450-U	90 €
Cromo	45 cm	R80LOU450-K	90 €
Negro mate		R80LOU450-H	90 €
Inox satinado		R80LOU450-Z	108 €

SISTEMA ESTABILIZADOR EVO (entre paredes)



Color Cores	Código	Precio Preço
Blanco mate Branco mate	KUADHSFN-U	180 €
Silver Brillantado	KUADHSFN-B	194 €
Cromo	KUADHSFN-K	216 €
Negro mate	KUADHSFN-H	216 €
Inox satinado	KUADHSFN-Z	260 €

- Barra frontal de 180 cms
- Pieza para sujeción a pared

SISTEMA ESTABILIZADOR EVO (ángulo)



Color Cores	Código	Precio Preço
Blanco mate Branco mate	KUADHSF-U	243 €
Silver Brillantado	KUADHSF-B	262 €
Cromo	KUADHSF-K	283 €
Negro mate	KUADHSF-H	283 €
Inox satinado	KUADHSF-Z	340 €

- Barra frontal de 180 cms
- Barra lateral de 120 cms
- Piezas para sujeción a pared
- 1 pieza para la unión angular

SISTEMA ESTABILIZADOR EVO (en C)



Color Cores	Código	Precio Preço
Blanco mate Branco mate	KUADHSFC-U	315 €
Silver Brillantado	KUADHSFC-B	329 €
Cromo	KUADHSFC-K	349 €
Negro mate	KUADHSFC-H	349 €
Inox satinado	KUADHSFC-Z	419 €

- 1 barra frontal de 180 cm
- 2 barras laterales de 120 cm
- 4 piezas de fijación al cristal
- 2 piezas para la unión angular

BARRAS DE SUJECCIÓN PARA KUADRA H Y GIADA H

PERFIL ESTANCO DE ALUMINIO PARA FIJOS DE 6/8 MM PERFIS ESTANCO DE ALUMÍNIO PARA FIXOS DE 6/8 MM



Color Cores	Medidas	Código	Precio Preço	
Blanco / Branco	100	P51BOHU10-A	30 €	
Blanco mate Branco mate		P51BOHU10-U	30 €	
Silver Brillantado		P51BOHU10-B	35 €	
Cromo		P51BOHU10-K	39 €	
Negro mate		P51BOHU10-H	39 €	
Inox satinado		P51BOHU10-Z	48 €	
Blanco / Branco		150	P51BOHU15-A	36 €
Blanco mate Branco mate			P51BOHU15-U	36 €
Silver Brillantado			P51BOHU15-B	41 €
Cromo			P51BOHU15-K	48 €
Negro mate	P51BOHU15-H		48 €	
Inox satinado	P51BOHU15-Z		57 €	

KIT PARA FIJACIÓN A TECHO DE LA BARRA DE SUJECCIÓN SUMINISTRADA KIT PARA FIXAÇÃO AO TECTO DA BARRA DE FIXAÇÃO (FORNECIDA)



Color Cores	Código	Precio Preço
Blanco / Branco	R801SOFEL-A	42 €
Cromo	R801SOFEL-K	46 €
Negro mate	R801SOFEL-H	46 €

El kit incluye sólo las dos piezas de fijación, para completar con la barra de 100 cm. suministrada.

BARRA ORIENTABLE



Color Cores	Medidas	Código	Precio Preço
Blanco mate Branco mate	100	R80KUOR100-U	111 €
Silver / Brillantado		R80KUOR100-B	124 €
Cromo		R80KUOR100-K	135 €
Negro mate		R80KUOR100-H	135 €
Inox satinado		R80KUOR100-Z	162 €
Blanco mate Branco mate	150	R80KUOR150-U	115 €
Silver / Brillantado		R80KUOR150-B	127 €
Cromo		R80KUOR150-K	140 €
Negro mate		R80KUOR150-H	140 €
Inox satinado		R80KUOR150-Z	168 €
Blanco mate Branco mate	180	R80KUOR180-U	121 €
Silver / Brillantado		R80KUOR180-B	131 €
Cromo		R80KUOR180-K	143 €
Negro mate		R80KUOR180-H	143 €
Inox satinado		R80KUOR180-Z	172 €

1 barra orientable de 100/150/180 cms ajustables a medida, 1 pieza de fijación a pared, 1 bisagra fija a cristal / 1 dobradiça fixa ao vidro

PIEZA PARA ELEVACIÓN DEL FIJO SOBRE EL PLATO DE DUCHA Ø 29 MM PEÇA PARA ELEVAÇÃO DO FIXO SOBRE A BASE DE CHUVEIRO Ø 29 MM



Código	Precio / Preço
R05KUHL1-K	64 €

Para Kuadra HL y Giada HL

PERFIL PARA FIJACIÓN A TECHO PERFIL DE FIJACIÓN AO TETO



Color Cores	Código	Precio Preço
Blanco Branco	R80GKHSOF-D	201 €
Blanco mate Branco mate	R80GKHSOF-U	201 €
Silver Brillantado	R80GKHSOF-B	222 €
Cromo	R80GKHSOF-K	244 €
Negro mate	R80GKHSOF-H	244 €
Inox satinado	R80GKHSOF-Z	293 €

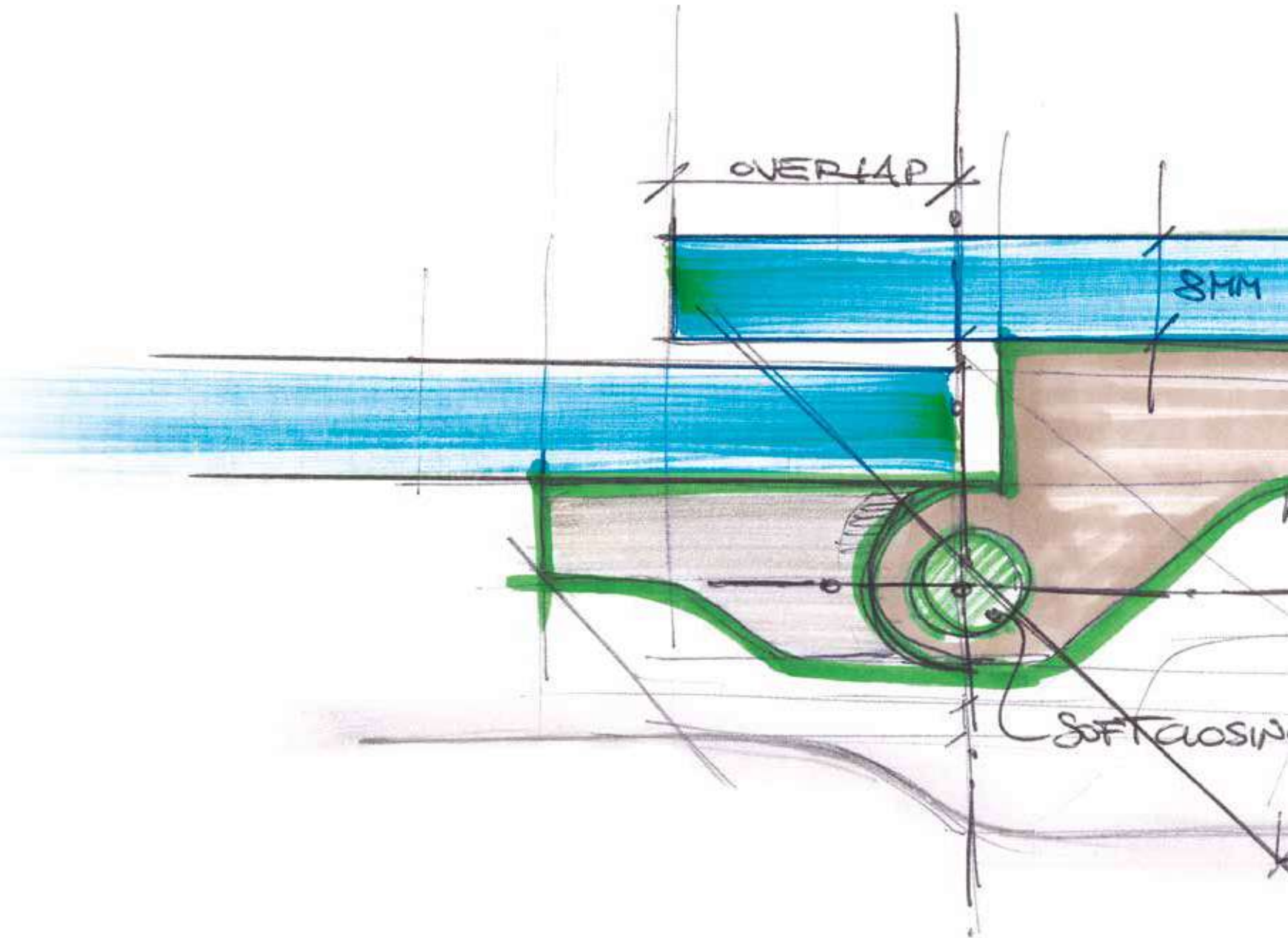

- 312 Kuadra
- 313 Young
- 316 Aurora



MAMPARAS DE BAÑERA

RESGUARDOS DE BANHEIRA

MAMPARA Y
BAÑERA EN UNA
MISMA SOLUCIÓN:
COMODIDAD Y
PRACTICIDAD
RESGUARDO
E BANHEIRA EM
UMA SOLUÇÃO:
CONFORTO E
PRACTICIDADE

Las renunciaciones no son para todos. La elección de la solución dos en uno logra el deseo de practicidad y satisface el deseo de conveniencia. Las mamparas de bañera Novellini ofrecen todo el bienestar y el placer de la bañera junto con la comodidad de la ducha. Para renovar el espacio o para nuevas instalaciones, es sin duda ideal para aquellos que saben lo que quieren: funcionalidad, facilidad, seguridad, versatilidad.

As renúncias não são para todos. A escolha da solução dois em um atinge o desejo de praticidade e satisfaz o desejo de conveniência. As resguardos de banheira Novellini oferecem todo o bem-estar e prazer da banheira, juntamente com o conforto do chuveiro. Para renovar o espaço ou para novas instalações, é sem dúvida ideal para quem sabe o que quer: funcionalidade, facilidade, segurança, versatilidade.

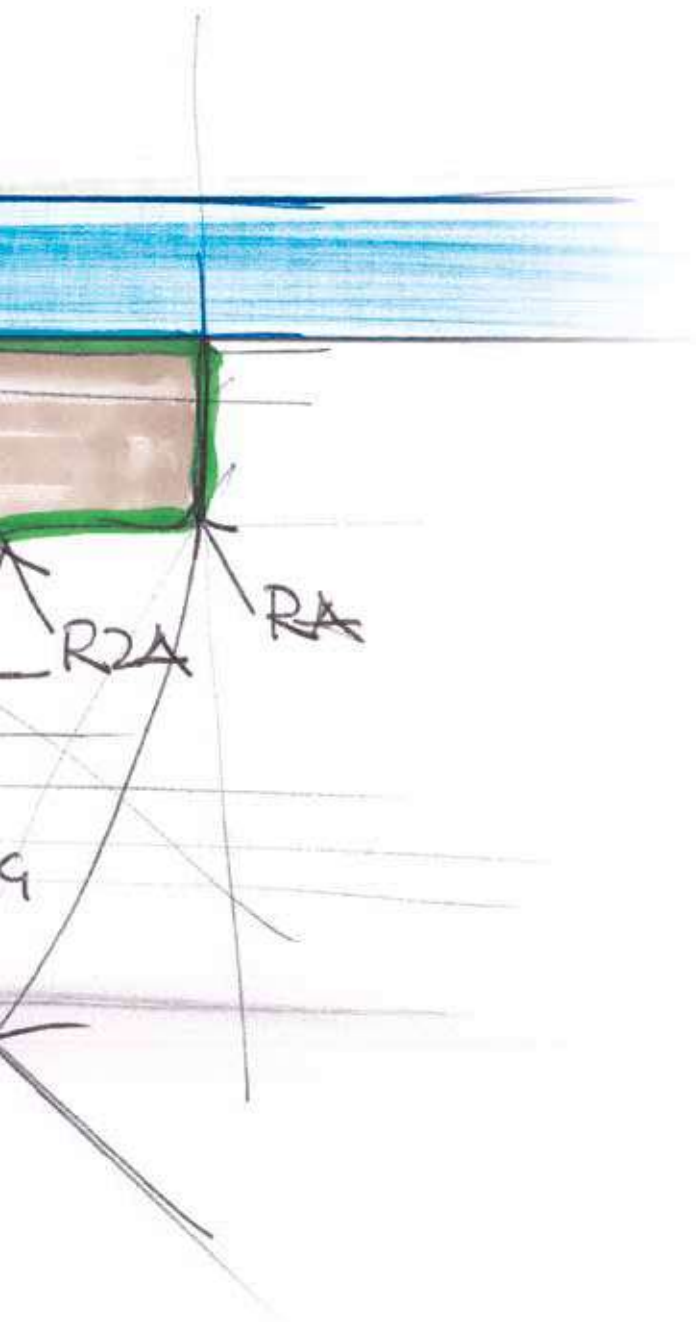

KUADRA 3V

MAMPARA DE BAÑERA , 1 FIJO Y 1 PUERTA GIRATORIA 180°
RESGUARDO DE BANHEIRA, 1 FIXO E 1 FOLHA GIRATÓRIA 180°



150 cm



8 mm



3 cm



CRISTAL TEMPLADO IDRO TEMPERADO



Transparente
cod 1

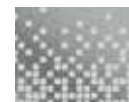

Ser. Ravenna
cod 51

COLORES PERFILES CORES PERFÍS



Blanco
Branco
cod A



Silver
Abrillantado
cod B



Cromo
cod K

Medidas	Código	Selección Cristales Seleção Vidros		Selección de perfiles Seleção de perfis		
		1	51	D	B	K
Medidas extensibilidad Medidas extensibilidade		Transparente	Ser. Ravenna	Blanco Branco	Silver Abrillantado	Cromo
97↔100	KUAD3V100-		+ 40 €	533 €	591 €	657 €

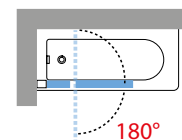
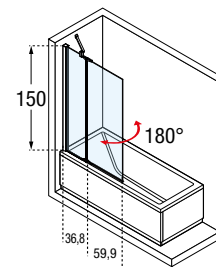

YOUNG 1V



151,6 cm



6 mm



2 cm



MAMPARA DE UNA HOJA GIRATORIA REVERSIBLE
MAMPARA DE UNA HOJA GIRATORIA REVERSIBLE



CRISTAL TEMPLADO VIDRO TEMPERADO



Transparente
cod 1



Aqua
cod 2



Satinado
Fosco
cod 4

COLORES PERFILES CORES PERFÍS



Blanco
Branco
cod A



Silver
Abrillantado
cod B



Cromo
cod K



Negro mate
cod H

Medidas	Código	Selección Cristales Seleção Vidros			Selección de perfiles Seleção de perfis			
		1	2	4	U	B	K	H
Medidas extensibilidad Medidas extensibilidade		Transparente	Aqua	Satinado Fosco	Blanco mate Branco mate	Silver Abrillantado	Cromo	Negro mate
70 x 151,6	Y21V70-				381 €	417 €	454 €	454 €
75 x 151,6	Y21V75-				395 €	432 €	472 €	472 €
80 x 151,6	Y21V80-		+ 40 €	+ 40 €	402 €	439 €	479 €	479 €
85 x 151,6	Y21V85-				418 €	455 €	496 €	496 €
90 x 151,6	Y21V90-				431 €	471 €	513 €	513 €

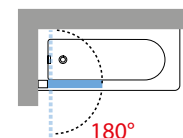
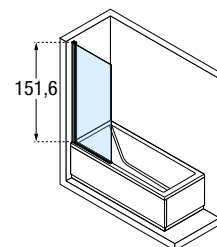

KIT ADAPTACIÓN PARA BAÑERA DIVINA



Para instalar en bañera DIVINA pedir:
1 mampara YOUNG 2.0 1V + 1 kit unión bañera

Código	Selección de perfiles Seleção de perfis		
	A	K	H
	Blanco Branco	Cromo	Negro mate
KITYD1V-	35 €	35 €	35 €

Construcción del código:
Construção do código

Código

+

Cristales
Vidros

+

Perfiles
Perfis

=

Código completo del producto
Código completo do produto

YOUNG 3V

MAMPARA DE BAÑERA , 1 FIJO Y 1 PUERTA GIRATORIA 180°
RESGUARDO DE BANHEIRA, 1 FIXO E 1 FOLHA GIRATÓRIA 180°



151,6 cm



6 mm



2 cm



CRISTAL TEMPLADO VIDRO TEMPERADO



Transparente
cod 1



Aqua
cod 2



Satinado
Fosco
cod 4

COLORES PERFILES CORES PERFÍS



Blanco
Branco
cod A



Silver
Abrillantado
cod B



Cromo
cod K



Negro mate
cod H

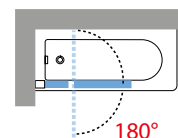
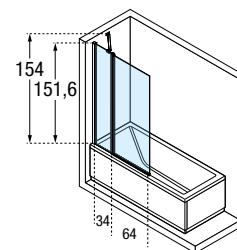

Medidas	Código	Selección Cristales Seleção Vidros			Selección de perfiles Seleção de perfis			
		1	2	4	U	B	K	H
Medidas extensibilidad Medidas extensibilidade		Transparente	Aqua	Satinado Fosco	Blanco mate Branco mate	Silver Abrillantado	Cromo	Negro mate
98 x 151,6	Y23V100-		+ 40 €	+ 40 €	481 €	525 €	575 €	575 €

YOUNG 1BSV



MAMPARA PARA BAÑERA FORMADA POR DOS HOJAS PLEGABLES Y ABATIBLE
RESGUARDO DE BANHEIRA, 2 FOLHAS DESDOBRÁVEL



CRISTAL TEMPLADO VIDRO TEMPERADO



Transparente
cod 1

Aqua
cod 2



Satinado
Fosco
cod 4

COLORES PERFILES CORES PERFIS



Blanco
Branco
cod A

Silver
Abrillantado
cod B



Cromo
cod K

Negro mate
cod H

Medidas	Código	Derecha	Izquierda	Selección Cristales			Selección de perfiles			
		Direita	Esquerda	Seleção Vidros			Seleção de perfis			
Medidas extensibilidad	Medidas extensibilidad	D-	S-	1	2	4	U	B	K	H
120 x 151,6	Y21BSV120	D-	S-	Transparente	Aqua	Satinado Fosco	Blanco mate	Silver	Cromo	Negro mate
					+ 40 €	+ 40 €	583 €	643 €	708 €	708 €

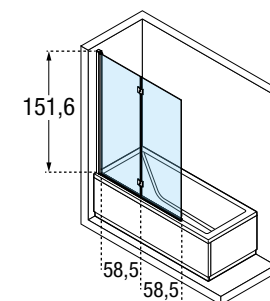

KIT ADAPTACIÓN PARA BAÑERA DIVINA



Para instalar en bañera DIVINA pedir:
1 mampara YOUNG 2.0 1V + 1 kit unión bañera

Código	Selección de perfiles		
	Seleção de perfis		
	A	K	H
	Blanco Branco	Cromo	Negro mate
KITYD1V-	35 €	35 €	35 €

Construcción del código: **Código** + **Izquierda / Derecha** + **Cristales** + **Perfiles** = Código completo del producto
Construção do código: **Código** + **Esquerda / Direita** + **Vidros** + **Perfis** = Código completo do produto

AURORA 1

MAMPARA DE UNA HOJA GIRATORIA REVERSIBLE
MAMPARA DE UNA HOJA GIRATORIA REVERSIBLE



150 cm



6 mm



3 cm



CRISTAL TEMPLADO VIDRO TEMPERADO



Transparente
cod 1



Aqua
cod 2



Satinado
Fosco
cod 4

COLORES PERFILES CORES PERFÍS



Blanco
Branco
cod A



Silver
Abrillantado
cod B



Cromo
cod K

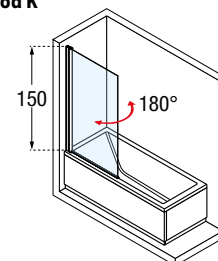

Medidas	Código	Selección Cristales Seleção Vidros			Selección de perfiles Seleção de perfis		
		1	2	4	A	B	K
Medidas extensibilidad Medidas extensibilidade		Transparente	Aqua	Satinado Fosco	Blanco Branco	Silver Abrillantado	Cromo
70 X 150 H	AURORAN170-				305 €	337 €	371 €
75 X 150 H	AURORAN175-				321 €	353 €	389 €
80 X 150 H	AURORAN180-		+ 40 €	+ 40 €	336 €	370 €	406 €
85 X 150 H	AURORAN185-				350 €	386 €	426 €
L 45↔100 x H 100↑170	ESPECIAL AURORAN1SP		+ 40 €	+ 40 €	427 €	471 €	518 €

AURORA 2



MAMPARA DE DOS HOJAS GIRATORIAS REVERSIBLE
RESGUARDO DE DUAS FOLHAS GIRATÓRIAS REVERSÍVEL



CRISTAL TEMPLADO VIDRO TEMPERADO



Transparente
cod 1

Aqua
cod 2



Satinado
Fosco
cod 4

COLORES PERFILES CORES PERFÍS



Blanco
Branco
cod A

Silver
Abrillantado
cod B



Cromo
cod K

Medidas	Código	Selección Cristales Seleção Vidros			Selección de perfiles Seleção de perfis		
		1	2	4	A	B	K
Medidas extensibilidad Medidas extensibilidade		Transparente	Aqua	Satinado Fosco	Blanco Branco	Silver Abrillantado	Cromo
120 x 150 H	AURORAN2-		+ 40 €	+ 40 €	497 €	559 €	625 €
B1=30↔70 + B2=30↔60 x H 100↑150	AURORAN2SP		+ 40 €	+ 40 €	604 €	677 €	760 €

PANEL FIJO LATERAL PAINEL FIXO LATERAL

F

67↔70	AURORAN2FV70-			438 €	484 €	530 €
72↔75	AURORAN2FV75-	+ 40 €	+ 40 €	451 €	497 €	550 €
77↔80	AURORAN2FV80-			464 €	511 €	564 €

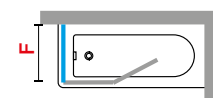
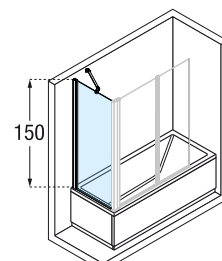
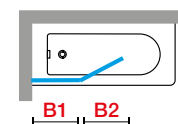
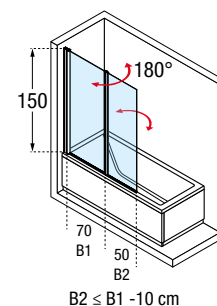

DIRECCIÓN DE GIRO



GIRO COMPLETO



Construcción del código:
Construção do código

Código

+

Cristales
Vidros

+

Perfiles
Perfis

=

Código completo del producto
Código completo do produto

AURORA 3

MAMPARA DE BAÑERA , 1 FIJO Y 1 PUERTA GIRATORIA 180°
RESGUARDO DE BANHEIRA, 1 FIXO E 1 FOLHA GIRATÓRIA 180°



150 cm



6 mm



3 cm



CRISTAL TEMPLADO / VIDRO TEMPERADO



Transparente
cod 1



Aqua
cod 2



Satinado
Fosco
cod 4

COLORES PERFILES / CORES PERFÍS



Blanco
Branco
cod A



Silver
Abrillantado
cod B



Cromo
cod K

Medidas	Código	Selección Cristales Seleção Vidros			Selección de perfiles Seleção de perfis		
		1	2	4	A	B	K
Medidas extensibilidad Medidas extensibilidade		Transparente	Aqua	Satinado Fosco	Blanco Branco	Silver Abrillantado	Cromo
98 x 150 H	AURORAN3-		+ 40 €	+ 40 €	413 €	466 €	528 €
30↔66 + 30↔80 x H 120†170	AURORAN3SP		+ 40 €	+ 40 €	504 €	569 €	644 €

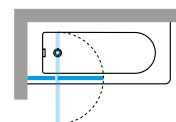
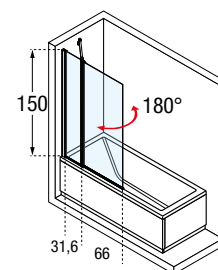

AURORA 4

CABINA PARA BAÑERA - DOS PUERTAS PLEGABLES



150 cm



5 mm se-
micircular /
semicircular



6 mm piso /
piso



3 cm



CRISTAL TEMPLADO / VIDRO TEMPERADO



Transparente
cod 1

COLORES PERFILES / CORES PERFÍS



Blanco
Branco
cod A



Silver
Abrillantado
cod B



Cromo
cod K

MAMPARAS
DE BAÑERA

Medidas	Código	Selección Cristales Seleção Vidros	Selección de perfiles Seleção de perfis		
Medidas extensibilidad Medidas extensibilidade		1	A	B	K
70 x 150 H	AURORA470-	Transparente	Blanco Branco	Silver Abrillantado	Cromo
75 x 150 H	AURORA475-		995 €	1.105 €	1.227 €
80 x 150 H	AURORA480-		995 €	1.105 €	1.227 €

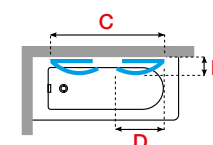
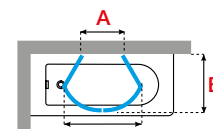
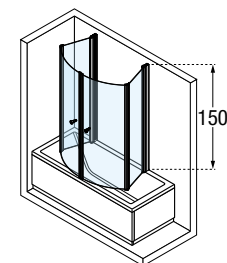

	A	B	C	D	E	F
70 cm	81	67	154	55	99,5	13,2
75 cm	81	72	164	55	99,5	13,2
80 cm	81	77	174	55	99,5	13,2

Construcción del código:
Construção do código

Código

+

Cristales
Vidros

+

Perfiles
Perfis

=

Código completo del producto
Código completo do produto

AURORA 5

PANEL FIJO
PAINEL FIXO



150 cm



6 mm



3 cm



CRISTAL TEMPLADO / VIDRO TEMPERADO



Transparente
cod 1

COLORES PERFILES / CORES PERFÍS



Blanco
Branco
cod A



Silver
Abrillantado
cod B



Cromo
cod K

Medidas	Código	Selección Cristales Seleção Vidros	Selección de perfiles Seleção de perfis		
		1	A	B	K
Medidas extensibilidad Medidas extensibilidade		Transparente	Blanco Branco	Silver Abrillantado	Cromo
70	AURORA570-		281 €	317 €	359 €
75	AURORA575-		297 €	337 €	381 €
80	AURORA580-		312 €	353 €	400 €
85	AURORA585-		329 €	373 €	422 €
H 100 ↓ 160 X L 40 ↔ 85 cm	AURORAN5SP		402 €	455 €	516 €

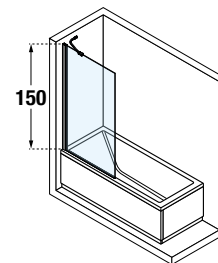

AURORA 9

MAMPARA DE BAÑERA FORMADA POR TRES HOJAS PLEGABLES
RESGUARDO BANHEIRA 3 FOLHAS DESDOBRÁVEL



138 cm



3 mm



CRISTAL TEMPLADO / VIDRO TEMPERADO



Transparente
cod 1



Estampado
cod 3



gotas
cod 16

COLORES PERFILES / CORES PERFIS



Blanco
Branco
cod A

MAMPARAS DE BAÑERA

Medidas	Código	Selección Cristales Seleção Vidros		Selección de perfiles Seleção de perfis	selección acrílico Seleção acrílico	Selección de perfiles Seleção de perfis
		1	3	A	16	A
Medidas extensibilidad Medidas extensibilidade		Transparente	Estampado	Blanco Branco	Anelli	Blanco Branco
138	AURORA93V-		+ 40 €	523 €		461 €

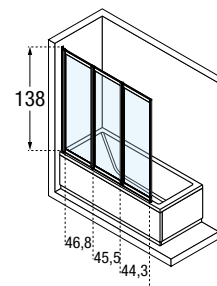

Construcción del código:
Construção do código

Código

+

Cristales
Vidros

+

Perfiles
Perfis

=

Código completo del producto
Código completo do produto

AURORA 3PV4

MAMPARA DE TRES HOJAS CORREDERAS
RESGUARDO DE 3 PORTAS DE CORRER



150 cm



3 mm



6 cm



CRISTAL TEMPLADO / VIDRO TEMPERADO



Transparente
cod 1



Estampado
cod 3



Ser. Esprit
cod 5



Circular
cod 43

COLORES PERFILES / CORES PERFÍS



Blanco
Branco
cod A



Silver
Abrillan-
tado
cod B



Cromo
cod K

Medidas		Código	Selección Cristales Seleção Vidros			Selección de perfiles Seleção de perfis			Selección acrílico Seleção acrílico	Selección de perfiles Seleção de perfis		
Medidas extensibilidad Medidas extensibilidade	Entrada		1	3	5	A	B	K	43	A	B	K
A	*		Transpa- rente	Estam- pado	Serig. Esprit	Blanco Branco	Silver Abrillan- tado	Cromo	circular	Blanco Branco	Silver Abrillan- tado	Cromo
138↔144	83	AURORA3PV138-				813 €	895 €	985 €		773 €	835 €	943 €
144↔150	87	AURORA3PV144-				813 €	895 €	985 €		773 €	835 €	943 €
150↔156	91	AURORA3PV150-				842 €	926 €	1.021 €		800 €	867 €	979 €
156↔162	95	AURORA3PV156-		+ 40 €	+ 40 €	842 €	926 €	1.021 €		800 €	867 €	979 €
162↔168	99	AURORA3PV162-				842 €	926 €	1.021 €		800 €	867 €	979 €
168↔174	103	AURORA3PV168-				872 €	959 €	1.057 €		830 €	896 €	1.014 €
174↔180	107	AURORA3PV174-				872 €	959 €	1.057 €		830 €	896 €	1.014 €

PUERTA DE ANCHURA ESPECIAL

L 180↔186	111	AURORA3PV180-								915 €	988 €	-
-----------	-----	----------------------	--	--	--	--	--	--	--	-------	-------	---

PUERTA DE ALTURA ESPECIAL

H 80↔160		AURORA3PVSP	+ 40 €	-		1.090 €	1.200 €	1.319 €		1.037 €	1.120 €	1.266 €
L 96↔186												

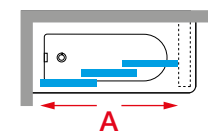
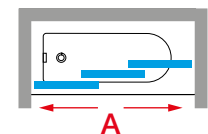
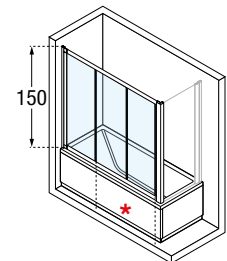

AURORA 2PV4



150 cm



4 mm



6 cm



MAMPARA DE BAÑERA DE DOS HOJAS: UNA CORREDERA + UNA FIJA
RESGUARDO DE BANHEIRA DE 2 FOLHAS; 1 PORTA DE CORRER + UMA FIXA



CRISTAL TEMPLADO / VIDRO TEMPERADO



Transparente
cod 1



Estampado
cod 3



Ser. Esprit
cod 5

COLORES PERFILES / CORES PERFIS



Blanco
Branco
cod A



Silver
Abrillantado
cod B



Cromo
cod K

MAMPARAS DE BAÑERA

Medidas			Código	Selección Cristales Seleção Vidros			Selección de perfiles Seleção de perfis		
Medidas extensibilidad Medidas extensibilidade	fijo panel en línea fijo painel em linha	Entrada		1	3	5	A	B	K
A	F1	*		Transparente	Estampado	Serig. Esprit	Blanco Branco	Silver Abrillantado	Cromo
138↔144	68	60	AURORA2PV138-				776 €	852 €	938 €
144↔150	71	63	AURORA2PV144-				776 €	852 €	938 €
150↔156	74	66	AURORA2PV150-				805 €	885 €	975 €
156↔162	77	69	AURORA2PV156-	+ 40 €		+ 40 €	805 €	885 €	975 €
166↔172	82	74	AURORA2PV166-				835 €	919 €	1.010 €
176↔182	87	79	AURORA2PV176-				835 €	919 €	1.010 €

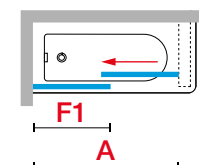
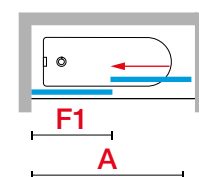
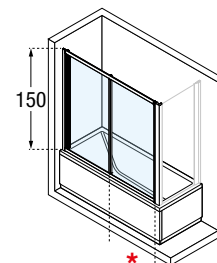

Construcción del código:
Construção do código

Código

+

Cristales
Vidros

+

Perfiles
Perfis

=

Código completo del producto
Código completo do produto

AURORA VFL4

PANEL FIJO LATERAL
PAINEL FIXO LATERAL



CRISTAL TEMPLADO VIDRO TEMPERADO



Transparente
cod 1

Estampado
cod 3



Ser. Esprit
cod 5

Circular
cod 43

COLORES PERFILES CORES PERFÍS



Blanco
Branco
cod A

Silver
Abrillantado
cod B



Cromo
cod K

Medidas	Código	Selección Cristales Seleção Vidros			Selección de perfiles Seleção de perfis			selección acrílico Seleção acrílico	Selección de perfiles Seleção de perfis		
		1	3	5	A	B	K	43	A	B	K
Medidas extensibilidad Medidas extensibilidade		Transparente	Estampado	Serig. Esprit	Blanco Branco	Silver Abrillantado	Cromo	circular	Blanco Branco	Silver Abrillantado	Cromo
62↔68	AURORAVFL62-				40 €	40 €	40 €		217 €	241 €	264 €
68↔74	AURORAVFL68-		+ 40 €	+ 40 €	40 €	40 €	40 €		233 €	258 €	284 €
74↔80	AURORAVFL74-				40 €	40 €	40 €		247 €	270 €	300 €
L 20↔100 H 80↔160	AURORAVFLSP		+ 40 €	-	338 €	373 €	410 €		305 €	337 €	371 €

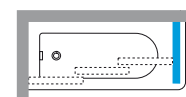
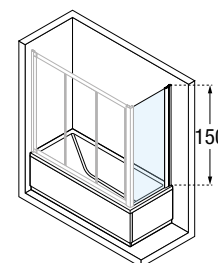

PARA INSTALACIONES CON 2 PANELES FIJOS LATERALES, UTILIZAR SIEMPRE 2 BARRAS DE SUJECIÓN EN ÁNGULO.



DATOS TÉCNICOS / DADOS TÉCNICOS

COLORES PERFILES / CORES PERFÍS



Blanco
Branco
cod. A-D



Silver
Abrillantado
cod. B



Cromo
cod. K



Negro mate
cod. H

CRISTAL / VIDRO (European standards UNE EN 14428)



Transparente
cod. 1



Aqua
cod. 2
(sólo para/só para: Young 2.0 1V, 3V, 1BSV, Aurora 1, 2, 3)



Estampado
cod. 3
(sólo para/só para: Aurora 9, 3PV4, 2SV4, 2AV4, VFL4)



Satinado
Fosco
cod. 4
(sólo para/só para Young 2.0 1V, 3V, 1BSV, Aurora 1, 2, 3)

SERIGRAFIA



Rose 1
cod. 56
(sólo para/só para Rose Rosse 2MV, 3PV, 2PV, PHV+F)



Esprit
cod. 5
(sólo para/só para Aurora 3PV4, 2SV4, 2AV4, VFL4)

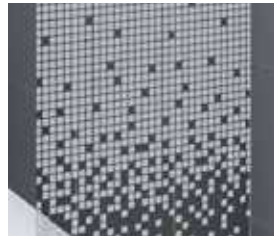

Ravenna
cod. 51
(sólo para/só para Kuadra 3V)



Riviera
code 55
(sólo para/só para RIVIERA 2.0 3PV+FV)

ACRILICO



Circular
cod. 43
(sólo para/só para Aurora 3PV4, VFL4)



Gotas
cod. 16
(sólo para/só para Aurora 9)

TOMA DE MEDIDAS

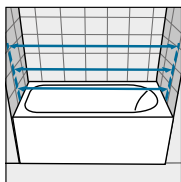
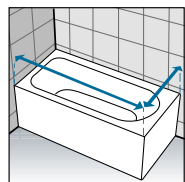

Tomar las medidas desde la pared hasta el borde externo de la bañera.
Medir a distância desde a parede até o rebordo externo da banheira.



- 329 Novosolid
- 335 Custom Touch
- 339 Custom
- 343 Olympic Plus
- 345 Olympic
- 347 Victory

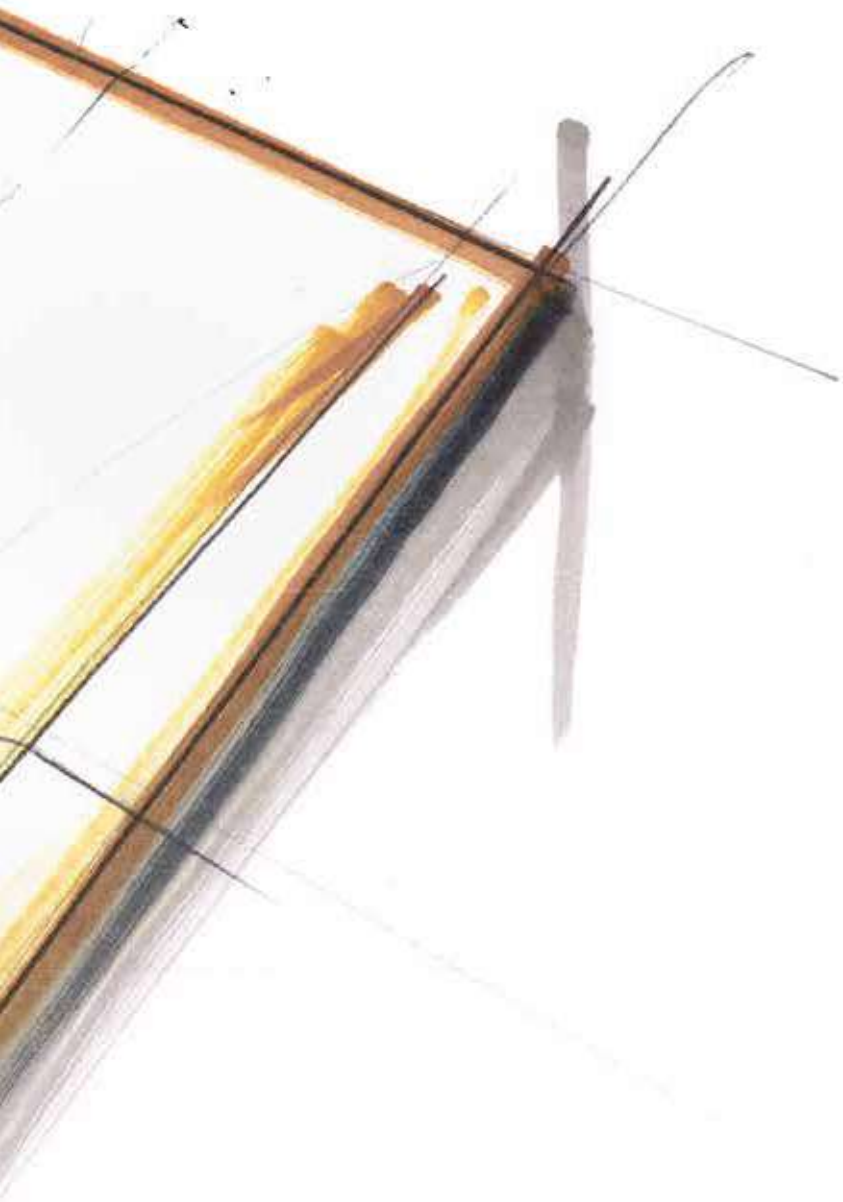

PLATOS DE DUCHA

BASES DE CHUVEIRO

LA OPCIÓN
CORRECTA SERVIDA
EN UN PLATO DE
DUCHA
*A ESCOLHA CERTA
SERVIDA EM UMA
BASE DE CHUVEIRO*

PLATOS DE DUCHA
BASES DE CHUVEIRO

Increíblemente resistente a los golpes y fácil de colocar, el plato de ducha Novellini se convierte en la base estable para el bienestar diario. Siempre esencial y elegante, el diseño se vuelve aún más moderno en la serie extra-plana. La facilidad de limpieza refuerza la funcionalidad de los elementos para la composición de un baño práctico y estético. Colores y tamaños, medidas y materiales permiten una personalización sin precedentes.

Incrivelmente resistente a choques e fácil de instalar, a base de chuveiro Novellini torna-se a base estável para o bem-estar diário. Sempre essencial e elegante, o design torna-se ainda mais moderno na série ultra plana. A facilidade de limpeza reforça a funcionalidade dos elementos para a composição de um banheiro prático e bonito. Cores e tamanhos, medidas e materiais permitem personalização sem precedentes.

NOVOSOLID

PLATO DE DUCHA DE RESINA BASE DE CHUVEIRO DE RESINA



◀ Válvula del mismo material
Válvula do mesmo material



◀ Fabricado con refuerzos
para garantizar una óptima
planimetría
*Fabricado com reforços
para garantir uma ótima
planimetría*



◀ Textura natural en acabado
pizarra y 4 colores a escoger

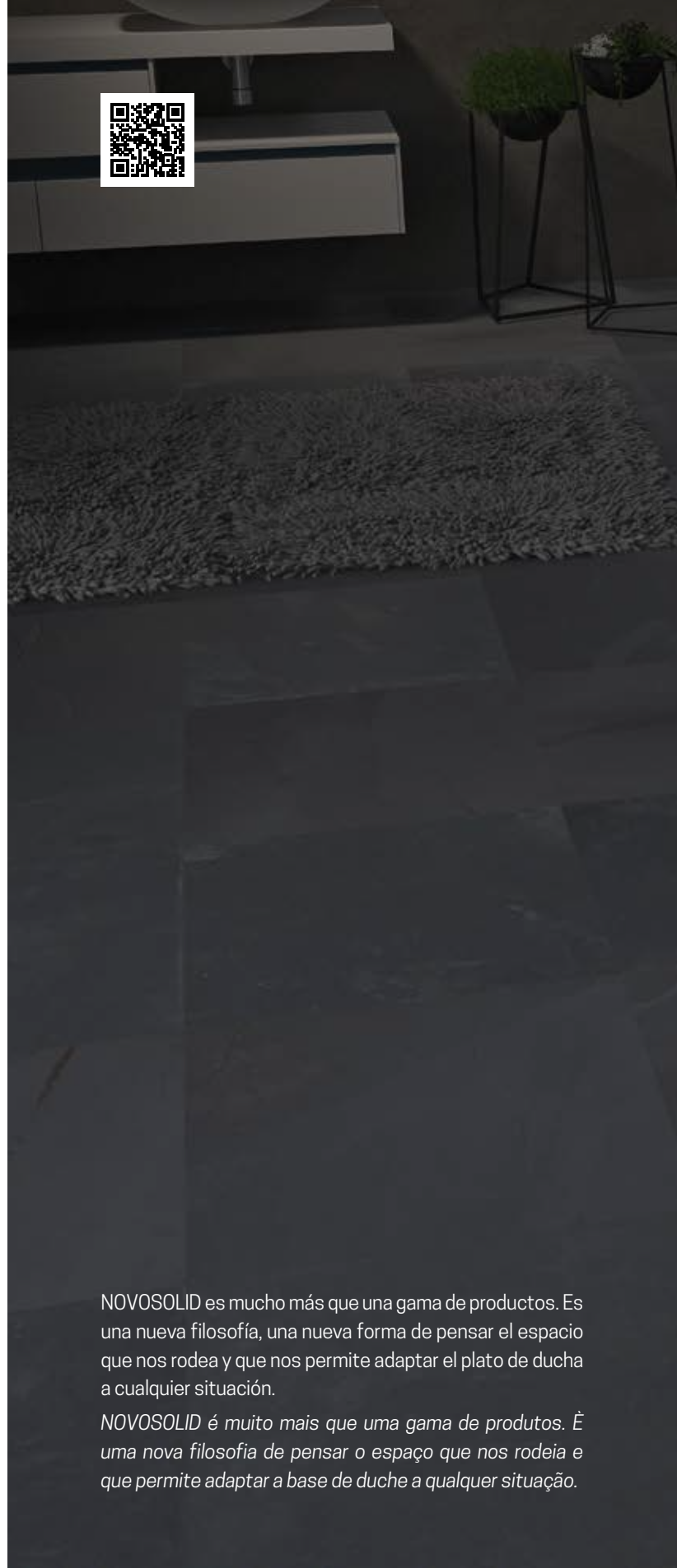

NOVOSOLID es mucho más que una gama de productos. Es una nueva filosofía, una nueva forma de pensar el espacio que nos rodea y que nos permite adaptar el plato de ducha a cualquier situación.

NOVOSOLID é muito mais que uma gama de produtos. É uma nova filosofia de pensar o espaço que nos rodeia e que permite adaptar a base de duche a qualquer situação.



NOVOSOLID

NOVOSOLID

NOVOSOLID

Medidas	Código	Selección de color / precio Seleção de cores de acabados / Preço			
		30	27	29	28
Ax B -2 / +3 mm		Blanco Branco	Corda	Gris Gris	Negro
80 x 80	NOS804-	573 €	629 €	629 €	660 €
90 x 90	NOS904-	626 €	689 €	689 €	724 €
100 x 100	NOS1004-	657 €	725 €	725 €	761 €
100 x 80	NOS100804-	626 €	689 €	689 €	724 €
120 x 70	NOS120704-	648 €	711 €	711 €	747 €
120 x 80	NOS120804-	695 €	764 €	764 €	802 €
120 x 90	NOS120904-	741 €	815 €	815 €	856 €
120 x 100	NOS120104-	785 €	865 €	865 €	908 €
140 x 70	NOS140704-	714 €	784 €	784 €	825 €
140 x 80	NOS140804-	755 €	829 €	829 €	870 €
140 x 90	NOS140904-	826 €	908 €	908 €	955 €
140 x 100	NOS140104-	853 €	939 €	939 €	987 €
150 x 70	NOS150704-	767 €	843 €	843 €	885 €
150 x 80	NOS150804-	800 €	880 €	880 €	924 €
160 x 70	NOS160704-	824 €	906 €	906 €	952 €
160 x 80	NOS160804-	848 €	932 €	932 €	979 €
160 x 90	NOS160904-	917 €	1.007 €	1.007 €	1.058 €
160 x 100	NOS160104-	975 €	1.071 €	1.071 €	1.125 €
170 x 70	NOS170704-	840 €	922 €	922 €	969 €
170 x 80	NOS170804-	940 €	1.032 €	1.032 €	1.085 €
180 x 80	NOS180804-	936 €	1.027 €	1.027 €	1.079 €
180 x 90	NOS180904-	1.011 €	1.111 €	1.111 €	1.167 €

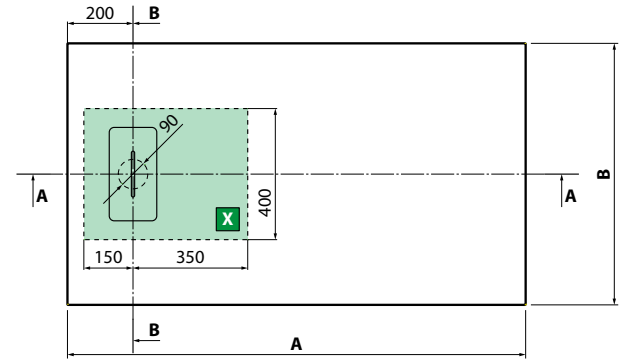

INSTALACIÓN DE APOYO SOBRE SUELO
INSTALAÇÃO DE APOIO AO CHÃO

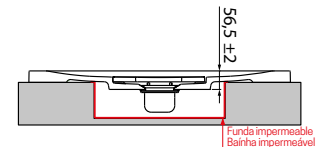
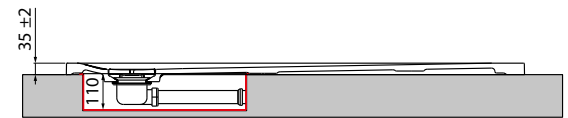

INSTALACIÓN OPCIONAL CON PIES REGULABLES Y PANEL AJUSTABLE A MEDIDA.
INSTALAÇÃO OPCIONAL COM PES REGULAVEIS E PAINEL AJUSTAVEL A MEDIDA.

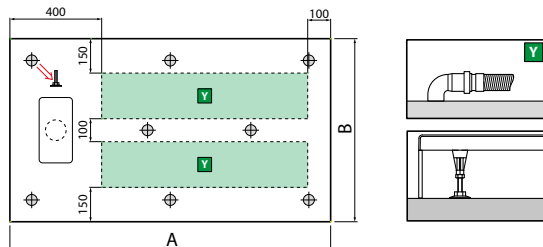
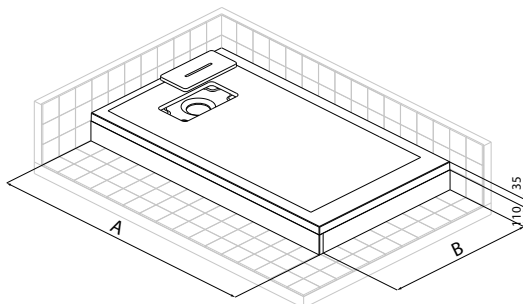

OPTION



Válvula de desagüe no incluida
Válvula não incluida

Código	Precio / Preço
PIL90PCAB-CR40	39 €

Para una optima instalación se aconseja usar nuestra válvula de desagüe **PIL90PCAB-CR40**, o una válvula equipada con doble junta.

Para uma optima instalação aconselha-se usar a nossa válvula de descarga **PIL90PCAB-CR40**, ou uma válvula equipada com junta dupla.

INSTALACIÓN A RAS DE SUELO
INSTALAÇÃO AO NÍVEL DO CHÃO



INSTALACIÓN DE APOYO SOBRE SUELO
INSTALAÇÃO DE APOIO AO CHÃO



INSTALACIÓN OPCIONAL CON PIES REGULABLES Y PANEL AJUSTABLE A MEDIDA.
INSTALAÇÃO OPCIONAL COM PES REGULAVEIS E PAINEL AJUSTAVEL A MEDIDA.



OPCIONAL

Kit de paneles para versión alta

- 1 panel lado corto de 90 cm + 1 panel lado largo*
- Altura del panel 11 cm.

Color Cores	Misura pannello lungo	Misura taglio min-max	Código	Precio / Preço
Blanco mate/Branco mate	100	70-100	PANPFLNS03-30	262 €
Corda	100	70-100	PANPFLNS03-27	264 €
Gris/Gris	100	70-100	PANPFLNS03-29	264 €
Negro mate	100	70-100	PANPFLNS03-28	267 €
Blanco mate/Branco mate	150	100-150	PANPFLNS02-30	297 €
Corda	150	100-150	PANPFLNS02-27	300 €
Gris/Gris	150	100-150	PANPFLNS02-29	300 €
Negro mate	150	100-150	PANPFLNS02-28	302 €
Blanco mate/Branco mate	180	150-180	PANPFLNS01-30	312 €
Corda	180	150-180	PANPFLNS01-27	316 €
Blanco mate/Branco mate	180	150-180	PANPFLNS01-29	316 €
Negro mate	180	150-180	PANPFLNS01-28	318 €

KIT DE REPARACIÓN / KIT DE REPARAÇÃO



OPCIONAL

KIT DE REPARACIÓN Compuesto de: resina bicomponente de protección para corte a medida + kit de reparación (en blister personalizado).

Color/Cores	Código	Precio / Preço
Blanco mate/Branco mate	KITRNS-30	147 €
Corda	KITRNS-27	148 €
Gris/Gris	KITRNS-29	148 €
Negro mate	KITRNS-28	150 €

CORTE

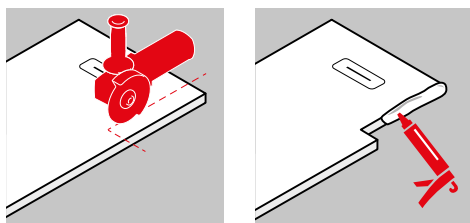

REPARACIÓN

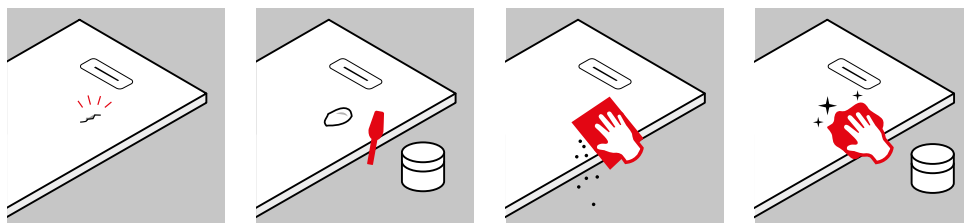

Novellini garantiza el producto incluso después del corte solo si la superficie ha sido tratada con el kit de reparación
Novellini confirma a garantia do produto mesmo depois do corte apenas se a superfície tiver sido tratada com o Kit de reparação.



CORTE ACONSEJADO EN LADO PARED
RECOMENDADO CORTE NO LADO DA PAREDE

CORTE A MEDIDA

NOVOSOLID es mucho más que un plato de ducha, es una nueva filosofía que permite concebir el espacio que nos rodea para adaptar el plato de ducha a muy diversas situaciones gracias a la posibilidad de ajustarlo hasta 9 cm en el lado largo y hasta 8 cm en el lado corto.

O NOVOSOLID é muito mais que uma base de duche, é uma nova filosofia pensar no espaço que o rodeia e permite adaptar a base de chuveiro a várias situações graças à possibilidade de o ajustar até 9 cm de comprimento e até 8 cm no lado mais curto.

CUSTOM TOUCH y CUSTOM

Es el plato de ducha:
É a base de chuveiro





1

ESTÉTICO Y FUNCIONAL

Con una altura de 3.5 cm y un exclusivo sistema de desagüe de 50 l/min, es el plato ideal para las instalaciones actuales con duchas de gran caudal.



Válvula de desagüe con capacidad de evacuación de 50 litros/minuto.

2

ADAPTABLE

Se pueda ajustar a medida de forma rápida y extremadamente limpia. 2 texturas y 6 colores disponibles.

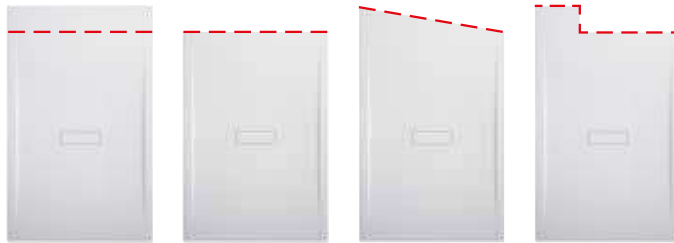

CUSTOM TOUCH

3

SÓLIDO Y LIGERO

Las barras perimetrales en acero le confieren planimetría perfecta y lo convierten en prácticamente indeformable.

Syntek Surface combina durabilidad y fácil instalación y transporte.

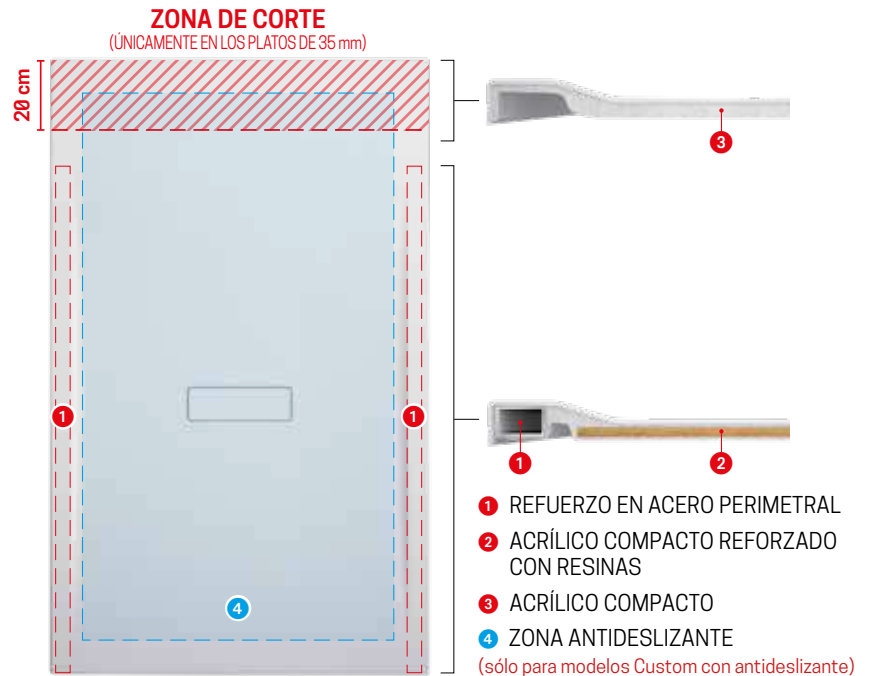

CUSTOM TOUCH

TECNOLOGIA Y
SIMPLICIDAD EN UN
UNICO PLATO

TECNOLOGIA E
SIMPLICIDADE EM UNA
ÚNICA BASE



◀ Nueva válvula de desagüe con caudal de 50 litros/ minuto con tapa de desagüe en acero inox pulido

Nova válvula de drenagem com uma taxa de fluxo de 50 litros/ minuto, com tampa de esgotos em aço inoxidável



◀ Efecto natural pizarra
Efeito natural ardósia



◀ Antideslizante y cálido al tacto
Antideslizante e quente ao toque



El primer plato Syntek Surface del mundo, sólido como la piedra. Antideslizante y cálido al tacto, resistente a los rayos UV, fácil de limpiar.

A primeira base em Syntek Surface do mundo, material como a pedra. Antideslizante e quente ao toque, resistente aos raios UV, fácil de limpar.



CUSTOM TOUCH

CUSTOM TOUCH

CUSTOM TOUCH

PLATO SOBRE ELEVADO
BORDE / REBORDO 3,5 CM.



Blanco mate
Branco mate

Beige

Corda

Gris

Negro mate

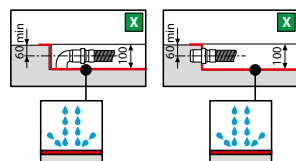
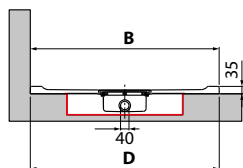
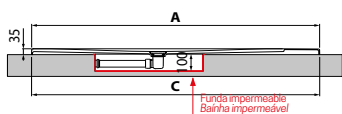
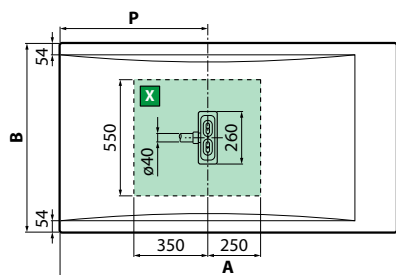

Medidas				Código	Selección de color / precio Seleção de cores de acabados / Preço				
AxB *± 2 mm	CxD **± 3 mm	P	79		11	27	29	28	
			Blanco mate Branco mate	Beige	Corda	Gris Gris	Negro		
100 x 80	994 x 792	996 x 794	400	CT100804-	597 €	628 €	628 €	628 €	628 €
120 x 70	1194 x 692	1196 x 694	500	CT120704-	606 €	636 €	636 €	636 €	636 €
120 x 80	1194 x 792	1196 x 794	500	CT120804-	613 €	646 €	646 €	646 €	646 €
120 x 90	1194 x 892	1196 x 894	500	CT120904-	640 €	675 €	675 €	675 €	675 €
120 x 100	1194 x 992	1196 x 994	500	CT120104-	667 €	703 €	703 €	703 €	703 €
140 x 70	1392 x 692	1394 x 694	600	CT140704-	631 €	663 €	663 €	663 €	663 €
140 x 80	1392 x 792	1394 x 794	600	CT140804-	659 €	692 €	692 €	692 €	692 €
140 x 90	1392 x 892	1394 x 894	600	CT140904-	694 €	731 €	731 €	731 €	731 €
160 x 70	1592 x 692	1594 x 694	700	CT160704-	666 €	700 €	700 €	700 €	700 €
160 x 80	1592 x 792	1594 x 794	700	CT160804-	718 €	755 €	755 €	755 €	755 €
160 x 90	1592 x 892	1594 x 894	700	CT160904-	726 €	763 €	763 €	763 €	763 €
180 x 80	1792 x 792	1794 x 794	800	CT180804-	755 €	793 €	793 €	793 €	793 €
180 x 90	1792 x 892	1794 x 894	800	CT180904-	776 €	815 €	815 €	815 €	815 €

* Medidas de la base del plato
Medidas de cima para a base

** Medidas del plato a suelo
Medições de base ao chão

INSTALACIÓN A RAS DE SUELO / INSTALAÇÃO AO NIVEL DO CHÃO

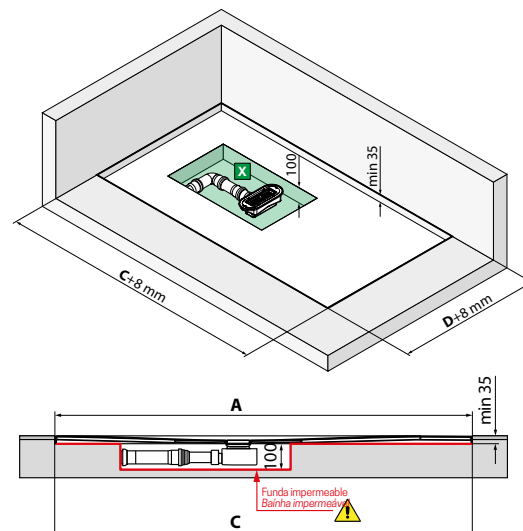

CUSTOM TOUCH

PLATO SOBRE ELEVADO
BORDE / REBORDO 12 CM.



PLATO NO RECORTABLE A MEDIDA



Blanco mate
Branco mate

Beige

Corda

Gris

Negro mate

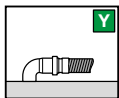
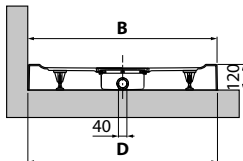
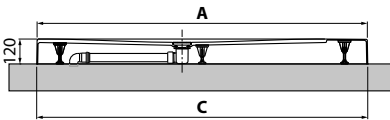
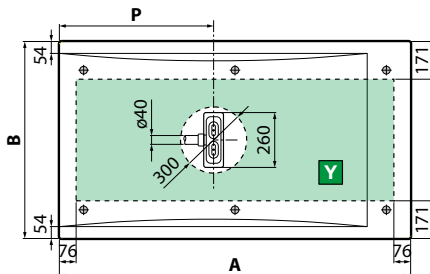

Medidas	Código	Selección de color / precio Seleção de cores de acabados / Preço							
		79	11	27	29	28			
		Blanco mate Branco mate	Beige	Corda	Gris Gris	Negro			
AxB *± 2 mm	CxD **± 3 mm	P							
100 x 80	994 x 792	1000 x 798	400	CT1008011-	597 €	628 €	628 €	628 €	628 €
120 x 70	1194 x 692	1200 x 698	500	CT1207011-	606 €	636 €	636 €	636 €	636 €
120 x 80	1194 x 792	1200 x 798	500	CT1208011-	613 €	646 €	646 €	646 €	646 €
120 x 90	1194 x 892	1200 x 898	500	CT1209011-	640 €	675 €	675 €	675 €	675 €
120 x 100	1194 x 992	1200 x 998	500	CT1201011-	667 €	703 €	703 €	703 €	703 €
140 x 70	1392 x 692	1398 x 698	600	CT1407011-	631 €	663 €	663 €	663 €	663 €
140 x 80	1392 x 792	1398 x 798	600	CT1408011-	659 €	692 €	692 €	692 €	692 €
140 x 90	1392 x 892	1398 x 898	600	CT1409011-	694 €	731 €	731 €	731 €	731 €
160 x 70	1592 x 692	1598 x 698	700	CT1607011-	666 €	700 €	700 €	700 €	700 €
160 x 80	1592 x 792	1598 x 798	700	CT1608011-	718 €	755 €	755 €	755 €	755 €
160 x 90	1592 x 892	1598 x 898	700	CT1609011-	726 €	763 €	763 €	763 €	763 €
180 x 80	1792 x 792	1798 x 798	800	CT1808011-	755 €	793 €	793 €	793 €	793 €
180 x 90	1792 x 892	1798 x 898	800	CT1809011-	776 €	815 €	815 €	815 €	815 €

* Medidas de la base del plato
Medidas de cima para a base

** Medidas del plato a suelo
Medições de base ao chão

OPCIONAL



Kit 2 embellecedores de plástico rígido 195 cm
Kit 2 embelezadores de plástico rígido 195 cm

Código	Precio / Preço
PRVA195-30	78 €

Construcción del código: Código + Colores/Coors = Código completo del producto
Construção do código: Código + Cores/Coors = Código completo do produto

CUSTOM

TECNOLOGIA Y
SIMPLICIDAD EN UN
UNICO PLATO
*TECNOLOGIA E
SIMPLICIDADE EM UNA
ÚNICA BASE*



◀ Nueva válvula de desagüe con caudal de 50 litros/ minuto con tapa de desagüe en acero inox pulido
Nova válvula de drenagem com uma taxa de fluxo de 50 litros/ minuto, com tampa de esgotos em aço inoxidável



◀ Perfil de refuerzo metálico
Perfil de reforço metálico



◀ Recortable para adaptarse a todas las necesidades.
Recorte para se adaptar a todas as necessidades

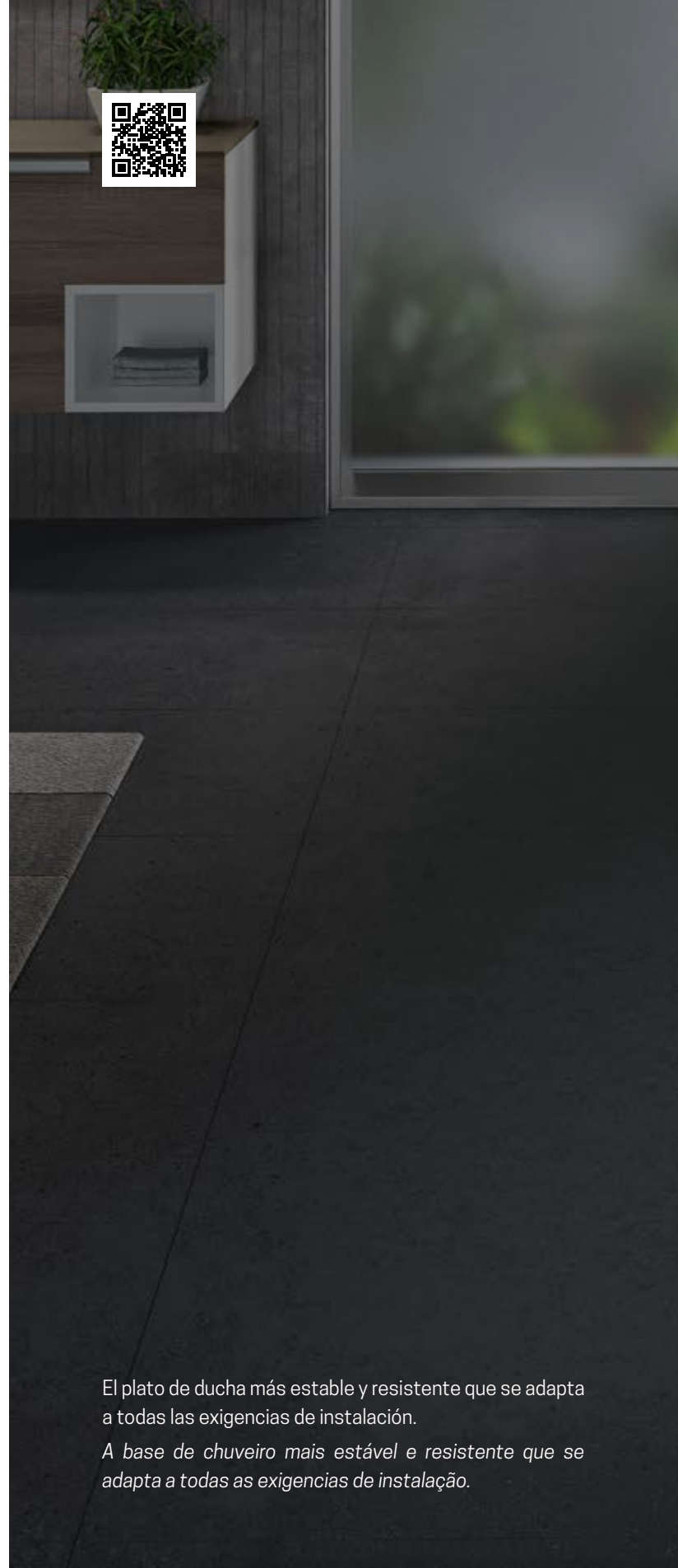

El plato de ducha más estable y resistente que se adapta a todas las exigencias de instalación.

A base de chuveiro mais estável e resistente que se adapta a todas as exigencias de instalação.



CUSTOM

CUSTOM

CUSTOM

PLATO SOBRE ELEVADO
BORDE / REBORDO 3,5 CM.



Blanco
Branco

Blanco mate
Branco mate

Beige

Corda

Gris

Negro mate

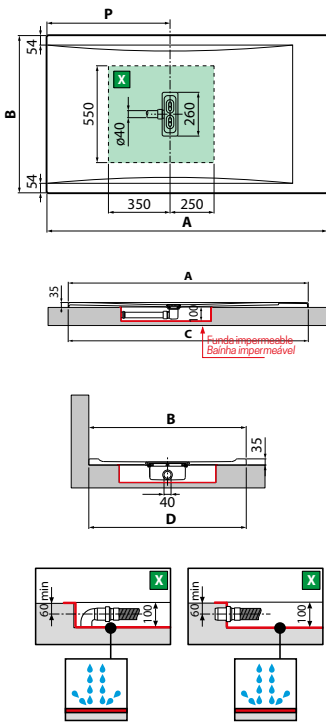

Medidas	Superficie lisa Código	Selección de color / precio Seleção de cores de acabados / Preço						con antideslizante Código	Precio / Preço		
		30	79	11	27	29	28				
AxB *± 2 mm	CxD **± 3 mm										
	P	Blanco Branco	Blanco mate Branco mate	Beige	Corda	Gris Gris	Negro		Blanco Branco		
100 x 80	994 x 792	996 x 794	400	CU100804-	355 €	532 €	564 €	564 €	564 €	CU100804A-	496 €
120 x 70	1194 x 692	1196 x 694	500	CU120704-	364 €	540 €	569 €	569 €	569 €	CU120704A-	506 €
120 x 80	1194 x 792	1196 x 794	500	CU120804-	373 €	546 €	577 €	577 €	577 €	CU120804A-	512 €
120 x 90	1194 x 892	1196 x 894	500	CU120904-	395 €	571 €	602 €	602 €	602 €	CU120904A-	535 €
120 x 100	1194 x 992	1196 x 994	500	CU120104-	423 €	596 €	631 €	631 €	631 €	CU120104A-	562 €
140 x 70	1392 x 692	1394 x 694	600	CU140704-	387 €	562 €	591 €	591 €	591 €	CU140704A-	528 €
140 x 80	1392 x 792	1394 x 794	600	CU140804-	413 €	587 €	619 €	619 €	619 €	CU140804A-	553 €
140 x 90	1392 x 892	1394 x 894	600	CU140904-	444 €	620 €	655 €	655 €	655 €	CU140904A-	585 €
160 x 70	1592 x 692	1594 x 694	700	CU160704-	419 €	594 €	625 €	625 €	625 €	CU160704A-	559 €
160 x 80	1592 x 792	1594 x 794	700	CU160804-	464 €	639 €	672 €	672 €	672 €	CU160804A-	603 €
160 x 90	1592 x 892	1594 x 894	700	CU160904-	472 €	647 €	682 €	682 €	682 €	CU160904A-	613 €
180 x 80	1792 x 792	1794 x 794	800	CU180804-	496 €	671 €	707 €	707 €	707 €	CU180804A-	635 €
180 x 90	1792 x 892	1794 x 894	800	CU180904-	517 €	693 €	736 €	736 €	736 €	CU180904A-	657 €

- * Medidas de la base del plato
Medidas de cima para a base
- ** Medidas del plato a suelo
Medições de base ao chão

INSTALACIÓN A RAS DE SUELO / INSTALAÇÃO AO NÍVEL DO CHÃO



SÓLO PARA PLATOS DE BORDE 3,5 CM
SÓ PARA BASES DE REBORDO DE 3,5 CM

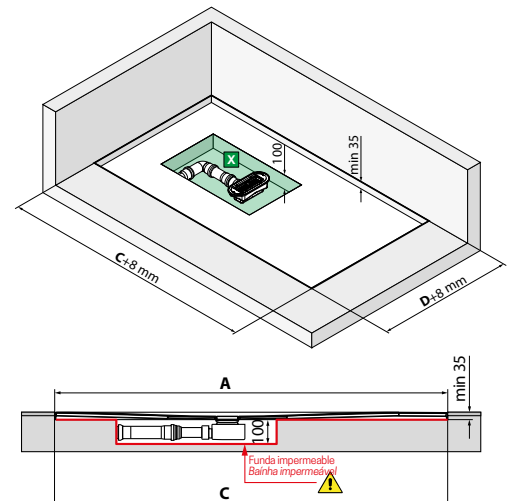

CUSTOM

PLATO SOBRE ELEVADO
BORDE / REBORDO 12 CM.



Blanco
Branco

Blanco mate
Branco mate

Beige

Corda

Gris

Negro mate

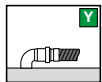
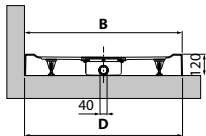
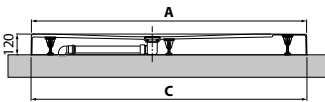
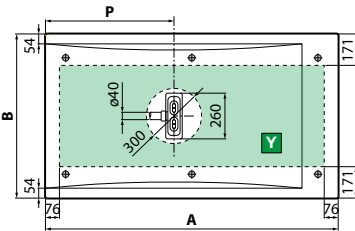

Medidas				Superficie lisa Código	Selección de color / precio Seleção de cores de acabados / Preço						con antideslizante Código	Precio / Preço
AxB	CxD	P			30	79	11	27	29	28		30
*± 2 mm	**± 3 mm				Blanco Branco	Blanco mate Branco mate	Beige	Corda	Gris Gris	Negro		Blanco Branco
100 x 80	994 x 792	1000 x 798	400	CU1008011-	335 €	532 €	564 €	564 €	564 €	564 €	CU1008011A-	496 €
120 x 70	1194 x 692	1200 x 698	500	CU1207011-	343 €	540 €	569 €	569 €	569 €	569 €	CU1207011A-	506 €
120 x 80	1194 x 792	1200 x 798	500	CU1208011-	352 €	546 €	577 €	577 €	577 €	577 €	CU1208011A-	512 €
120 x 90	1194 x 892	1200 x 898	500	CU1209011-	373 €	571 €	602 €	602 €	602 €	602 €	CU1209011A-	535 €
120 x 100	1194 x 992	1200 x 998	500	CU1201011-	399 €	596 €	631 €	631 €	631 €	631 €	CU1201011A-	562 €
140 x 70	1392 x 692	1398 x 698	600	CU1407011-	365 €	562 €	591 €	591 €	591 €	591 €	CU1407011A-	528 €
140 x 80	1392 x 792	1398 x 798	600	CU1408011-	390 €	587 €	619 €	619 €	619 €	619 €	CU1408011A-	553 €
140 x 90	1392 x 892	1398 x 898	600	CU1409011-	419 €	620 €	655 €	655 €	655 €	655 €	CU1409011A-	585 €
160 x 70	1592 x 692	1598 x 698	700	CU1607011-	395 €	594 €	625 €	625 €	625 €	625 €	CU1607011A-	559 €
160 x 80	1592 x 792	1598 x 798	700	CU1608011-	438 €	639 €	672 €	672 €	672 €	672 €	CU1608011A-	603 €
160 x 90	1592 x 892	1598 x 898	700	CU1609011-	445 €	647 €	682 €	682 €	682 €	682 €	CU1609011A-	613 €
180 x 80	1792 x 792	1798 x 798	800	CU1808011-	468 €	671 €	707 €	707 €	707 €	707 €	CU1808011A-	635 €
180 x 90	1792 x 892	1798 x 898	800	CU1809011-	488 €	693 €	736 €	736 €	736 €	736 €	CU1809011A-	657 €

* Medidas de la base del plato
Medidas de cima para a base

** Medidas del plato a suelo
Medições de base ao chão

OPCIONAL



Kit 2 embellecedores de plástico rígido 195 cm
Kit 2 embelezadores de plástico rígido 195 cm

Código	Precio / Preço
PRVA195-30	78 €

Construcción del código: Código + Colores/Colores = Código completo del producto
Construção do código: Código + Cores/Colores = Código completo do produto

OLYMPIC PLUS

**PLATO DE DUCHA REFORZADO
CON PERFIL METÁLICO
BASE DE DUCHE REFORÇADO
COM PERFIS METÁLICO**



Válvula de desagüe
ø 90 incluída
Válvula ø 90
incluído

NOVEDAD
fondo liso
NOVIDADE
fundo suave

Blanco
Branco
(30)

Blanco mate
Branco mate
(79)

Beige
(11)

Corda
(27)

Gris
(29)

Negro mate
(28)

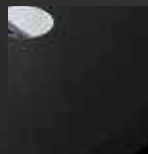
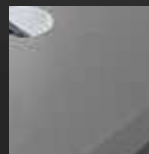
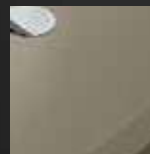
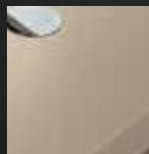

OPCIONAL

Embellecedor desagüe miosmo acabado que el plato

Color Cores	Código	Precio / Preço
Blanco brillo/Branco brilho	KR90CPILOLP-30	29 €
Blanco mate/Branco mate	KR90CPILOLP-79	29 €
Beige	KR90CPILOLP-11	29 €
Corda	KR90CPILOLP-27	29 €
Negro	KR90CPILOLP-28	29 €
Gris/Gris	KR90CPILOLP-29	29 €

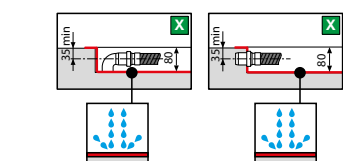
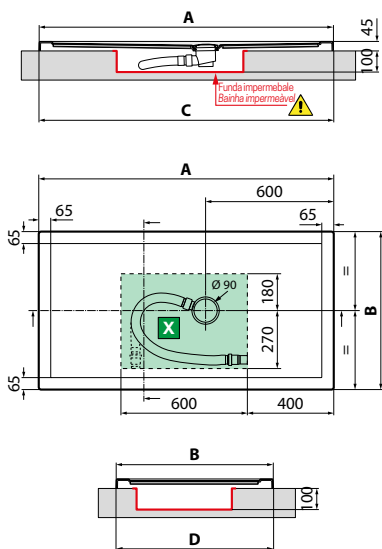

X Altura necesaria empotrada en el suelo para el desagüe H100 mm



* Perfil de refuerzo metálico

OLYMPIC PLUS

BORDE / REBORDO 4,5 CM

Medidas		Código	Selección de color / precio Seleção de cores de acabados / Preço						
AxB *± 2 mm	CxD **± 3 mm		30	79	11	27	29	28	
			Blanco Branco	Blanco mate Branco mate	Beige	Corda	Gris Gris	Negro	
110 x 70	1094 x 692	1096 x 694	OL110704-	283 €	459 €	484 €	484 €	484 €	484 €
110 x 80	1094 x 792	1096 x 794	OL110804-	289 €	465 €	492 €	492 €	492 €	492 €
120 x 70	1194 x 692	1196 x 694	OL120704-	294 €	469 €	496 €	496 €	496 €	496 €
120 x 80	1194 x 792	1196 x 794	OL801204-	300 €	475 €	506 €	506 €	506 €	506 €
120 x 90	1194 x 892	1196 x 894	OL120904-	323 €	498 €	530 €	530 €	530 €	530 €
120 x 100	1194 x 992	1196 x 994	OL120104-	343 €	518 €	550 €	550 €	550 €	550 €
140 x 70	1392 x 692	1394 x 694	OL140704-	315 €	491 €	519 €	519 €	519 €	519 €
140 x 75	1392 x 742	1394 x 744	OL140754-	315 €	491 €	519 €	519 €	519 €	519 €
140 x 80	1392 x 792	1394 x 794	OL140804-	341 €	516 €	546 €	546 €	546 €	546 €
140 x 90	1392 x 892	1394 x 894	OL140904-	374 €	549 €	582 €	582 €	582 €	582 €
140 x 100	1392 x 992	1394 x 994	OL140104-	390 €	565 €	599 €	599 €	599 €	599 €
150 x 70	1492 x 692	1494 x 694	OL150704-	326 €	500 €	532 €	532 €	532 €	532 €
150 x 75	1492 x 742	1494 x 744	OL150754-	345 €	519 €	553 €	553 €	553 €	553 €
160 x 70	1592 x 692	1594 x 694	OL160704-	347 €	522 €	554 €	554 €	554 €	554 €
160 x 75	1592 x 742	1594 x 744	OL160754-	354 €	530 €	562 €	562 €	562 €	562 €
160 x 80	1592 x 792	1594 x 794	OL160804-	391 €	566 €	601 €	601 €	601 €	601 €
160 x 90	1592 x 892	1594 x 894	OL160904-	400 €	576 €	612 €	612 €	612 €	612 €
170 x 70	1692 x 692	1694 x 694	OL170704-	358 €	534 €	566 €	566 €	566 €	566 €
170 x 75	1692 x 742	1694 x 744	OL170754-	386 €	561 €	596 €	596 €	596 €	596 €
170 x 80	1692 x 792	1694 x 794	OL170804-	396 €	572 €	608 €	608 €	608 €	608 €
170 x 90	1692 x 892	1694 x 894	OL170904-	422 €	597 €	633 €	633 €	633 €	633 €
180 x 75	1792 x 742	1794 x 744	OL180754-	402 €	578 €	614 €	614 €	614 €	614 €
180 x 80	1792 x 792	1794 x 794	OL180804-	424 €	599 €	635 €	635 €	635 €	635 €
180 x 90	1792 x 892	1794 x 894	OL180904-	448 €	623 €	661 €	661 €	661 €	661 €

OLYMPIC PLUS

OLYMPIC PLUS

BORDE / REBORDO 12,5 CM

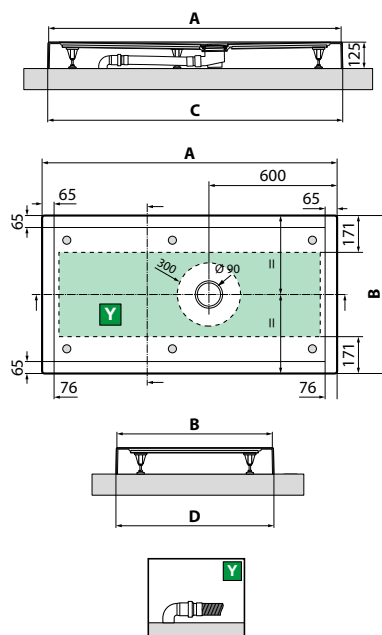

Y Área disponible de desagüe por encima del pavimento

* Medidas de la base del plato
Medidas de cima para a base
** Medidas del plato a suelo
Medições de base ao chão

Medidas		Código	Selección de color / precio Seleção de cores de acabados / Preço						
AxB *± 2 mm	CxD **± 3 mm		30	79	11	27	29	28	
			Blanco Branco	Blanco mate Branco mate	Beige	Corda	Gris Gris	Negro	
110 x 70	1094 x 692	1100 x 698	OL1107011-	283 €	459 €	484 €	484 €	484 €	484 €
110 x 80	1094 x 792	1100 x 798	OL1108011-	289 €	465 €	492 €	492 €	492 €	492 €
120 x 70	1194 x 692	1200 x 698	OL1207011-	294 €	469 €	496 €	496 €	496 €	496 €
120 x 80	1194 x 792	1200 x 798	OL8012011-	300 €	475 €	506 €	506 €	506 €	506 €
120 x 90	1194 x 892	1200 x 898	OL1209011-	323 €	498 €	530 €	530 €	530 €	530 €
120 x 100	1194 x 992	1200 x 998	OL1201011-	343 €	518 €	550 €	550 €	550 €	550 €
140 x 70	1392 x 692	1398 x 698	OL1407011-	315 €	491 €	519 €	519 €	519 €	519 €
140 x 75	1392 x 742	1398 x 748	OL1407511-	315 €	491 €	519 €	519 €	519 €	519 €
140 x 80	1392 x 792	1398 x 798	OL1408011-	341 €	516 €	546 €	546 €	546 €	546 €
140 x 90	1392 x 892	1398 x 898	OL1409011-	374 €	549 €	582 €	582 €	582 €	582 €
140 x 100	1392 x 992	1398 x 998	OL1401011-	390 €	565 €	599 €	599 €	599 €	599 €
150 x 70	1492 x 692	1498 x 698	OL1507011-	326 €	500 €	532 €	532 €	532 €	532 €
150 x 75	1492 x 742	1498 x 748	OL1507511-	345 €	519 €	553 €	553 €	553 €	553 €
160 x 70	1592 x 692	1598 x 698	OL1607011-	347 €	522 €	554 €	554 €	554 €	554 €
160 x 75	1592 x 742	1598 x 748	OL1607511-	354 €	530 €	562 €	562 €	562 €	562 €
160 x 80	1592 x 792	1598 x 798	OL1608011-	391 €	566 €	601 €	601 €	601 €	601 €
160 x 90	1592 x 892	1598 x 898	OL1609011-	400 €	576 €	612 €	612 €	612 €	612 €
170 x 70	1692 x 692	1698 x 698	OL1707011-	358 €	534 €	566 €	566 €	566 €	566 €
170 x 75	1692 x 742	1698 x 748	OL1707511-	386 €	561 €	596 €	596 €	596 €	596 €
170 x 80	1692 x 792	1698 x 798	OL1708011-	396 €	572 €	608 €	608 €	608 €	608 €
170 x 90	1692 x 892	1698 x 898	OL1709011-	422 €	597 €	633 €	633 €	633 €	633 €
180 x 75	1792 x 742	1798 x 748	OL1807511-	402 €	578 €	614 €	614 €	614 €	614 €
180 x 80	1792 x 792	1798 x 798	OL1808011-	424 €	599 €	635 €	635 €	635 €	635 €
180 x 90	1792 x 892	1798 x 898	OL1809011-	448 €	623 €	661 €	661 €	661 €	661 €

OLYMPIC



**PLATO DE DUCHA
CUADRADO O RECTANGULAR
BASE DE CHUVEIRO
QUADRADA OU RECTANGULAR**

NOVEDAD
fondo liso
NOVIDADE
fundo suave



OPCIONAL

Válvula de desagüe no
incluída/Válvula não incluída

Código	Precio Preço
PIL90PCAB-CR40	39 €

Para una óptima instalación se aconseja usar nuestra válvula de desagüe **PIL90PCAB-CR40**, o una válvula equipada con doble junta
Para uma óptima instalação aconséha-se usar a nossa válvula de descarga **PIL90PCAB-CR40**, ou uma válvula equipada com junta dupla

Blanco
Branco
(30)
Blanco mate
Branco mate
(79)

Beige
(11)

Corda
(27)

Gris
(29)

Negro mate
(28)



OPCIONAL

Embelecedor desagüe mismo acabado que el plato

Color Cores	Código	Precio Preço
Blanco brillo/Branco brilho	KR90CPILOLP-30	29 €
Blanco mate/Branco mate	KR90CPILOLP-79	29 €
Beige	KR90CPILOLP-11	29 €
Corda	KR90CPILOLP-27	29 €
Negro	KR90CPILOLP-28	29 €
Gris/Gris	KR90CPILOLP-29	29 €

OLYMPIC

BORDE / REBORDO 4,5 CM

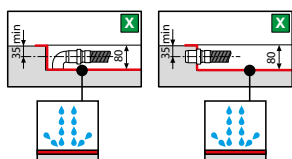
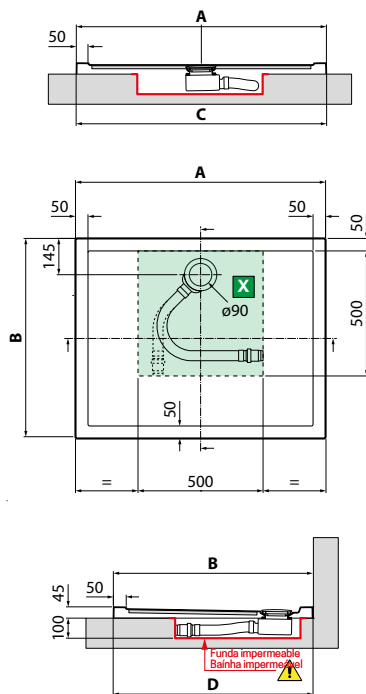

Medidas	Código	Selección de color / precio Seleccção de cores de acabados / Preço					
		30	79	11	27	29	28
		Blanco Branco	Blanco mate Branco mate	Beige	Corda	Gris Gris	Negro
80 x 80	794 x 794 796 x 796	OLN804-	232 €	402 €	424 €	424 €	424 €
90 x 90	894 x 894 896 x 896	OLN904-	252 €	423 €	445 €	445 €	445 €
100 x 100	994 x 994 996 x 996	OLN1004-	279 €	448 €	472 €	472 €	472 €
90 x 70	894 x 694 896 x 696	OLN90704-	239 €	408 €	431 €	431 €	431 €
90 x 75	894 x 744 896 x 746	OLN90754-	252 €	423 €	445 €	445 €	445 €
100 x 70	994 x 694 996 x 696	OLN100704-	265 €	437 €	459 €	459 €	459 €
100 x 80	994 x 794 996 x 796	OLN100804-	272 €	443 €	465 €	465 €	465 €
120 x 80	1194 x 794 1196 x 796	OLN120804-	279 €	448 €	472 €	472 €	472 €
120 x 90	1194 x 894 1196 x 896	OLN120904-	305 €	475 €	500 €	500 €	500 €

* Medidas de la base del plato
Medidas de cima para a base

** Medidas del plato a suelo
Medições de base ao chão



* Perfil de refuerzo metálico

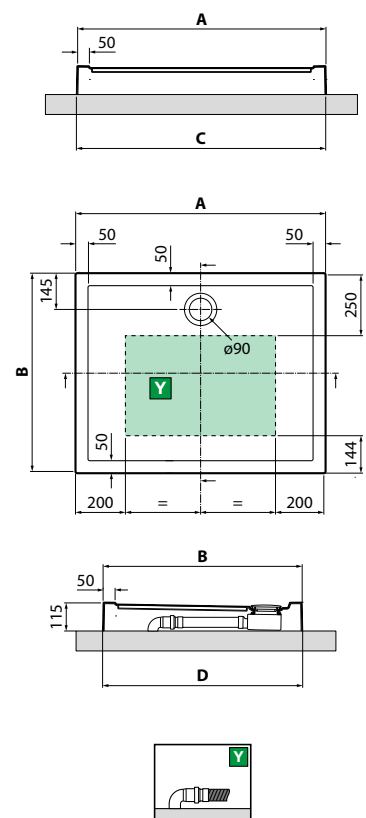

OLYMPIC

BORDE / REBORDO 11,5 CM

Medidas	Código	Selección de color / precio Seleccção de cores de acabados / Preço					
		30	79	11	27	29	28
		Blanco Branco	Blanco mate Branco mate	Beige	Corda	Gris Gris	Negro
80 x 80	794 x 794 798 x 798	OLN8011-	232 €	402 €	424 €	424 €	424 €
90 x 90	894 x 894 898 x 898	OLN9011-	252 €	423 €	445 €	445 €	445 €
100 x 100	994 x 994 998 x 998	OLN10011-	279 €	448 €	472 €	472 €	472 €
90 x 70	894 x 694 898 x 698	OLN907011-	239 €	408 €	431 €	431 €	431 €
90 x 75	894 x 744 898 x 748	OLN907511-	252 €	423 €	445 €	445 €	445 €
100 x 70	994 x 694 998 x 698	OLN1007011-	265 €	437 €	459 €	459 €	459 €
100 x 80	994 x 794 998 x 798	OLN1008011-	272 €	443 €	465 €	465 €	465 €
120 x 80	1194 x 794 1198 x 798	OLN1208011-	279 €	448 €	472 €	472 €	472 €
120 x 90	1194 x 894 1198 x 898	OLN1209011-	305 €	475 €	500 €	500 €	500 €

* Medidas de la base del plato
Medidas de cima para a base

** Medidas del plato a suelo
Medições de base ao chão

VICTORY



PLATO DE DUCHA SEMICIRCULAR BASE DE CHUVEIRO SEMICIRCULAR

NOVEDAD
fondo liso
NOVIDADE
fundo suave



OPCIONAL

Válvula de desagüe no
incluída/Válvula não incluída

Código	Precio / Preço
PIL90PCAB-CR40	39 €

Para una óptima instalación se aconseja usar nuestra válvula de desagüe **PIL90PCAB-CR40**, o una válvula equipada con doble junta
Para uma óptima instalação aconselha-se usar a nossa válvula de descarga **PIL90PCAB-CR40**, ou uma válvula equipada com junta dupla



Blanco
Branco
(30)
Blanco mate
Branco mate
(79)

Beige
(11)

Corda
(27)

Gris
(29)

Negro mate
(28)



OPCIONAL

Embelecedor desagüe mismo acabado que el plato

Color Cores	Código	Precio / Preço
Blanco brillo/Branco brilho	KR90CPILOLP-30	29 €
Blanco mate/Branco mate	KR90CPILOLP-79	29 €
Beige	KR90CPILOLP-11	29 €
Corda	KR90CPILOLP-27	29 €
Negro	KR90CPILOLP-28	29 €
Gris/Gris	KR90CPILOLP-29	29 €

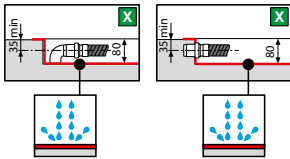
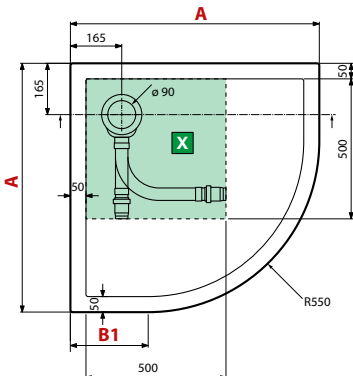
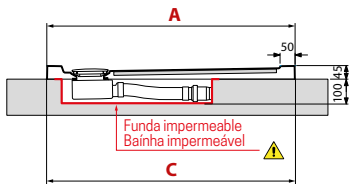

VICTORY

BORDE / REBORDO 4,5 CM

Medidas	Código	Selección de color / precio Seleção de cores de acabados / Preço								
		30	79	11	27	29	28			
		Blanco Branco	Blanco mate Branco mate	Beige	Corda	Gris Gris	Negro			
80 x 80	VINR804-	794	244	796	285 €	465 €	490 €	490 €	490 €	490 €
90 x 90	VINR904-	894	344	896	304 €	485 €	511 €	511 €	511 €	511 €
100 x 100	VINR1004-	994	444	996	318 €	500 €	525 €	525 €	525 €	525 €

* Perfil de refuerzo metálico

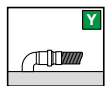
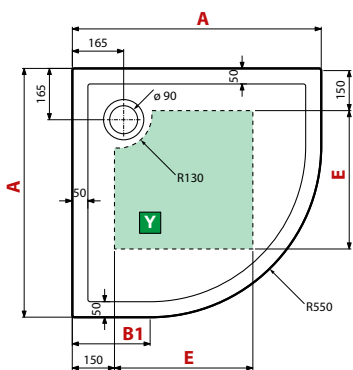
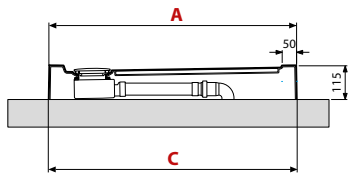

VICTORY

BORDE / REBORDO 11,5 CM

Medidas	Código	Selección de color / precio Seleção de cores de acabados / Preço								
		30	79	11	27	29	28			
		Blanco Branco	Blanco mate Branco mate	Beige	Corda	Gris Gris	Negro			
80 x 80	VINR8011-	794	244	400	798	285 €	465 €	490 €	490 €	490 €
90 x 90	VINR9011-	894	344	500	898	304 €	485 €	511 €	511 €	511 €
100 x 100	VINR10011-	994	444	600	998	318 €	500 €	525 €	525 €	525 €

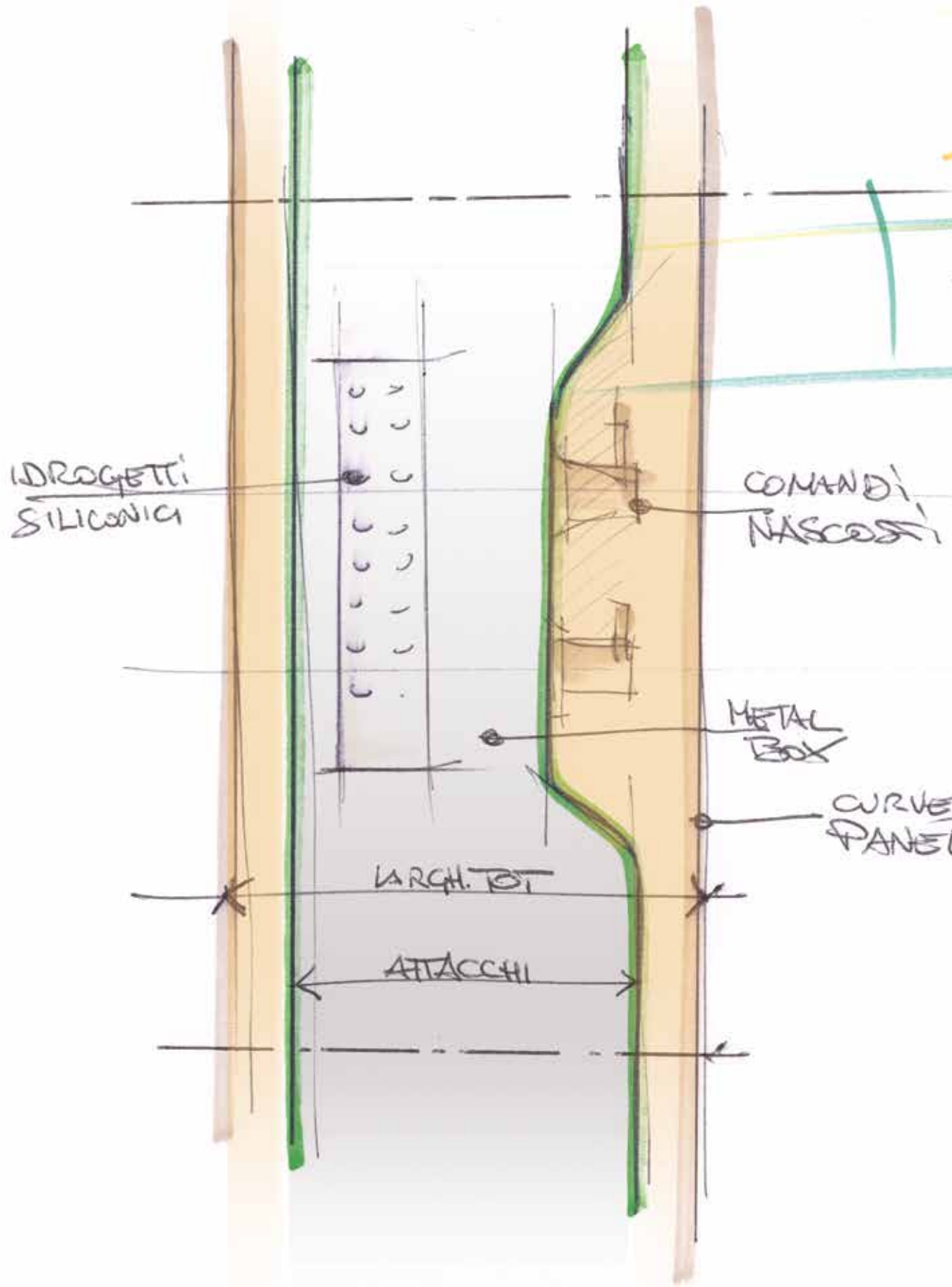

- 350 F
- 351 Z
- 353 Easy
- 355 Line
- 357 Revif
- 358 Vanity



COLUMNAS *COLUNAS*

EL COMPLEMENTO
MÁS ACERTADO
EN TU DUCHA
- EXPRESA
BIENESTAR
*O COMPLEMENTO
ADEQUADO PARA
O SEU CHUVEIRO -
SIGNIFICA
BEM-ESTAR*

La revolución con pocos y simples pasos. Las columnas Novellini completan el baño con mucha facilidad, añadiendo la nota de bienestar que faltaba para brindarte cada día una experiencia de ensueño en tu ducha gracias al hidromasaje integrado. Diseño esencial y refinado, montaje a pared o en ángulo y con una infinidad de detalles que marcan la diferencia.

A revolução em alguns passos simples. As colunas de duche Novellini completam o espaço da casa de banho com muita facilidade, acrescentando a nota de bem-estar que faltava para proporcionar-lhe todos os dias uma experiência de duche de sonho graças à hidromassagem integrada. Design essencial e refinado, montagem em parede ou canto e uma infinidad de detalhes que fazem a diferença.

F

COLUMNA DE LATÓN CROMADO CON DUCHA FIJA TELESCÓPICA. INSTALACIÓN A PARED FRONTAL COLUNA MULTIFUNÇÃO DE LATÃO CROMADO.

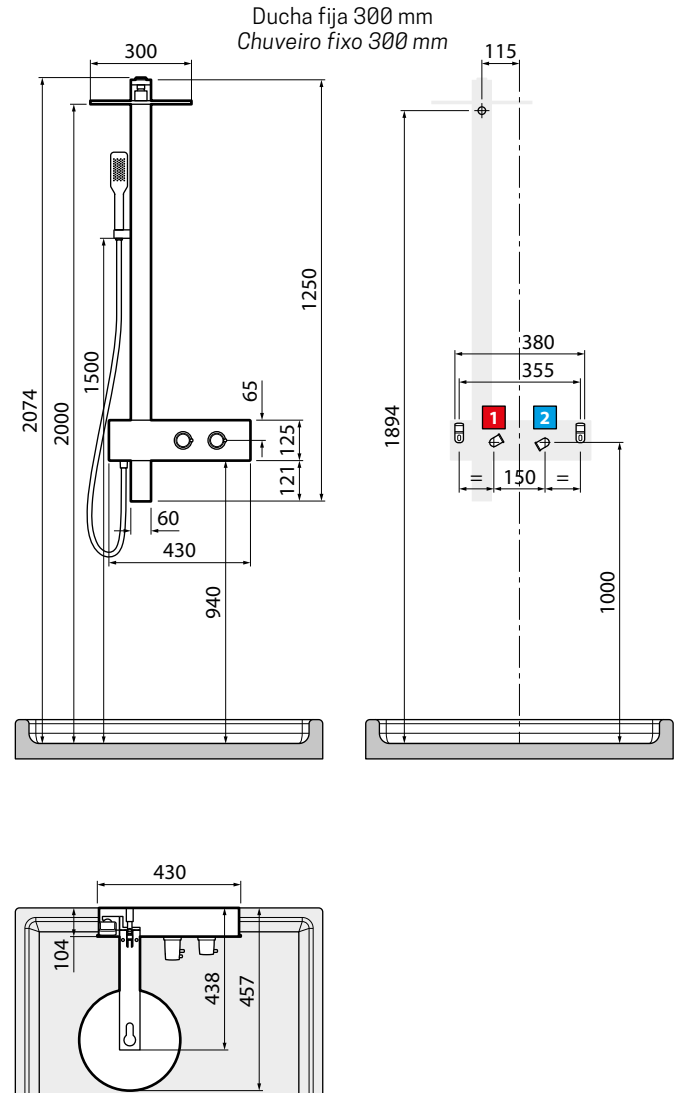

Mezclador Misturadora	Medidas (cm)	Código	Color Cores		
			U Blanco mate Branco mate	H Negro mate	B Silver Abrilantado

STANDARD					
Monomando Monocomando	42x8,4x125	EFFEM-	1.212 €	1.574 €	1.393 €
Termostático Termostática	42x8,4x125	EFFET-	1.299 €	1.662 €	1.481 €

Z

COLUMNA DE LATÓN CROMADO CON DUCHA FIJA TELESCÓPICA. INSTALACIÓN A PARED FRONTAL COLUNA MULTIFUNÇÃO DE LATÃO CROMADO.

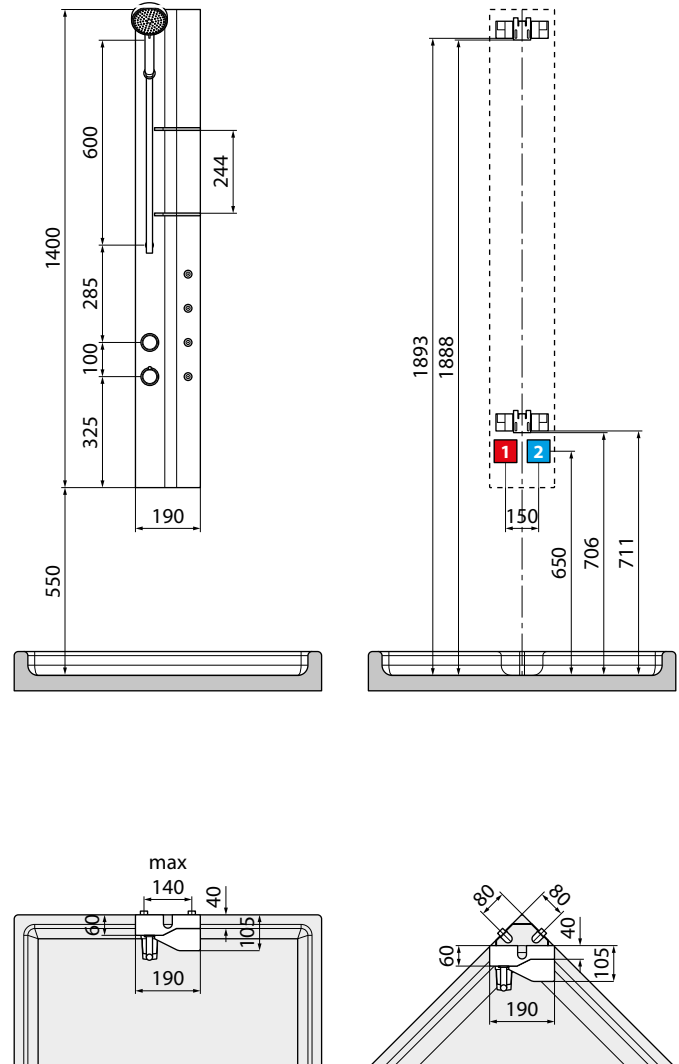

Mezclador Misturadora	Medidas (cm)	Código	Color Cores		
			U	H	B
			Blanco mate Branco mate	Negro mate	Silver Abrillantado

STANDARD					
Monomando Monocomando	19x6x140	ZETAM-	835 €	919 €	919 €
Termostático Termostática	19x6x140	ZETAT-	922 €	1.006 €	1.006 €
HIDROMASAJE / HIDROMASSAGEM					
Monomando Monocomando	19x6x140	ZETAVM-	1.087 €	1.170 €	1.170 €
Termostático Termostática	19x6x140	ZETA VT-	1.174 €	1.258 €	1.258 €

EASY 2

COLUMNA DE LATÓN CROMADO CON DUCHA FIJA TELESCÓPICA. INSTALACIÓN A PARED FRONTAL
COLUNA MULTIFUNÇÃO DE LATÃO CROMADO.



Ducha fija de 200x200 mm
 Chuveiro fixo 200x200 mm

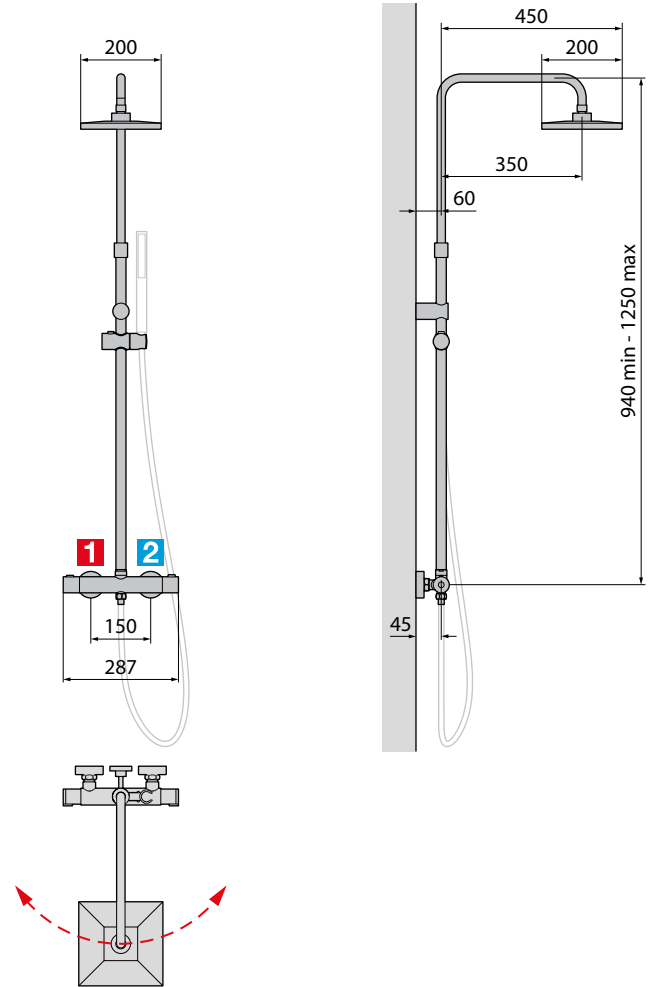

Mezclador Misturadora	Medidas (cm)	Código	Precio / Preço	
			K Cromo	H Negro mate
Termostático Termostática	29 x H 125	EASY2T-	694 €	937 €



1 2 Tomas para grifería

- 1** **CARACTERÍSTICAS HIDRÁULICAS**
CARACTERÍSTICAS HIDRÁULICAS
- 2** **CARACTERÍSTICAS HIDRÁULICAS**
- Presión requerida 2÷5 bar
 - Pressão requerida 2/5 bar
 - Agua caliente 1/2"
 - Água quente 1/2"
 - Agua fría 1/2"
 - Água fria 1/2"

PROMOSTOCK

EASY 2R

COLUMNA DE LATÓN CROMADO CON DUCHA FIJA TELESCÓPICA. INSTALACIÓN A PARED FRONTAL
COLUNA MULTIFUNÇÃO DE LATÃO CROMADO



Ducha fija 300 mm
 Chuveiro fixo 300 mm

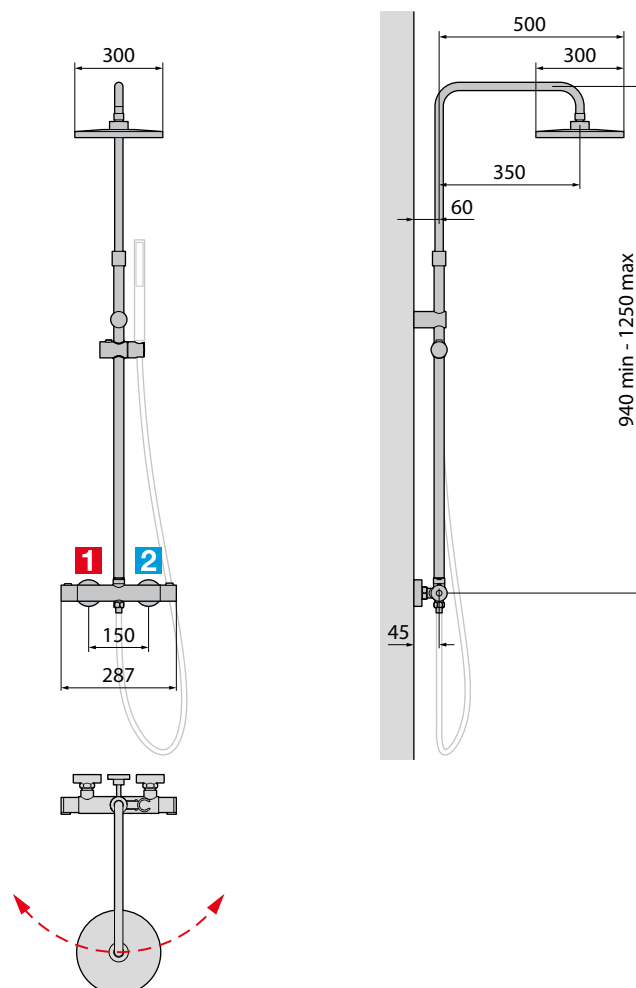

COLUMNAS
 COLUNAS

Mezclador Misturadora	Medidas (cm)	Código	Precio / Preço	
			K Cromo	H Negro mate
Termostático Termostática	29 x H 125	EASY2R-	799 €	1.079 €



1 2 Tomas para grifería

- 1** CARACTERÍSTICAS HIDRÁULICAS
 CARACTERÍSTICAS HIDRÁULICAS
- 2** CARACTERÍSTICAS HIDRÁULICAS
 CARACTERÍSTICAS HIDRÁULICAS
- Presión requerida 2÷5 bar
 - Pressão requerida 2/5 bar
 - Agua caliente 1/2"
 - Água quente 1/2"
 - Agua fría 1/2"
 - Água fria 1/2"

Construcción del código: **Código** + **Color Cores** = Código completo del producto
 Construção do código: **Código** + **Color Cores** = Código completo do produto

LINE 1

COLUMNA DE HIDROMASAJE DE ALUMINIO. INSTALACIÓN A PARED FRONTAL O EN ANGULO

COLUNA MULTIFUNÇÃO DE ALUMINIO.

Design Marco Pellici

Ducha fija de 200x200 mm
Chuveiro fixo 200x200 mm

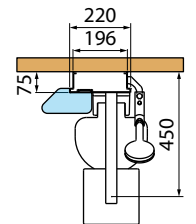
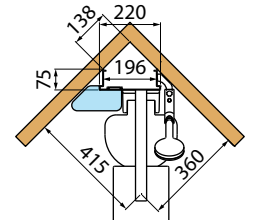
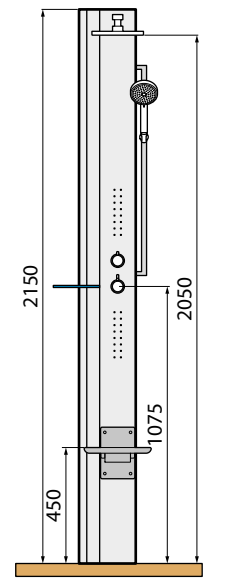
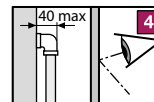
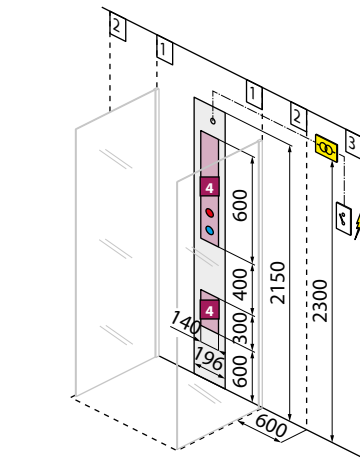
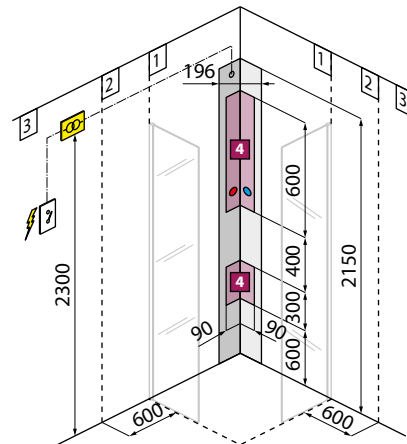

Mezclador Misturadora	Medidas (cm)	Código	Selección de color / precio		Seleção de cores de acabados / Preço				
			Silver Abrillantado	Tortora	Plata Prata	Tortora	Negro mate	Negro mate	Blanco mate Branco mate
			Columnas blanco mate franja y repisa franja e prateleira		columnas negro franja y repisa franja e prateleira		columnas plata franja y repisa franja e prateleira	columnas silver franja y repisa franja e prateleira	
			UB	UN2	HJ	HN2	JH	BH	BU
			Silver Abrillantado	Tortora	Plata Prata	Tortora	Negro mate	Negro mate	Blanco mate Branco mate

SIN ASIENTO / SEM ASSENTO									
Monomando Monocomando	22 x 7,5 x H215	LINE1M-	1.314 €	1.314 €	1.476 €	1.476 €	1.405 €	1.476 €	1.476 €
Termostático Termostática	22 x 7,5 x H215	LINE1T-	1.399 €	1.399 €	1.560 €	1.560 €	1.489 €	1.560 €	1.560 €

HIDROSAMAJE CON ASIENTO / HIDROMASAGEM COM ASSENTO									
			Asiento blanco Asiento branco		asiento negro mate		asiento negro mate	asiento negro mate	Asiento blanco Asiento branco
Monomando Monocomando	22 x 7,5 x H215	LINE1PVM-	1.825 €	1.825 €	1.984 €	1.984 €	1.915 €	1.984 €	1.984 €
Termostático Termostática	22 x 7,5 x H215	LINE1PVT-	1.908 €	1.908 €	2.069 €	2.069 €	1.998 €	2.069 €	2.069 €

LIGHT									
			Asiento blanco Asiento branco		asiento negro mate		asiento negro mate	asiento negro mate	Asiento blanco Asiento branco
Monomando Monocomando	22 x 7,5 x H215	LINE1PVML-	2.162 €	2.162 €	2.324 €	2.324 €	2.253 €	2.324 €	2.324 €
Termostático Termostática	22 x 7,5 x H215	LINE1PVTL-	2.247 €	2.247 €	2.406 €	2.406 €	2.337 €	2.406 €	2.406 €

1 2 Tomas para grifería



CARACTERÍSTICAS HIDRÁULICAS
CARACTERÍSTICAS HIDRÁULICAS

- Presión requerida 2+5 bar
- Pressão requerida 2/5 bar
- Agua caliente 1/2"
- Água quente 1/2"
- Agua fría 1/2"
- Água fria 1/2"

CARACTERÍSTICAS ELÉCTRICAS
CARACTERÍSTICAS ELÉTRICAS

- 220-230 V
- 50/60 Hz
- Potencia nominal: 25 W

Antes de la instalación eléctrica de la columna, debe instalarse un diferencial de 30mA provisto de interruptor con ≥ 3 mm, de apertura mínima de los contactos.

Antes da instalação elétrica da cabine, deve instalar-se um diferencial de 30 mA provisto de interruptor com ≥ 3 mm de abertura mínima dos contatos.

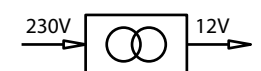

LINE 2

COLUMNA DE HIDROMASAJE DE ALUMINIO. INSTALACIÓN A PARED FRONTAL O EN ANGULO

COLUNA MULTIFUNÇÃO DE ALUMINIO.

Design Marco Pellici

Ducha fija de 200x200 mm

Chuveiro fixo 200x200 mm

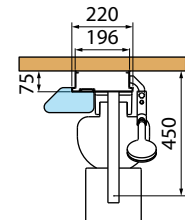
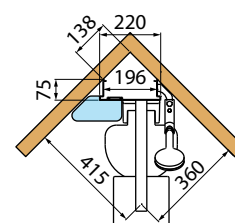
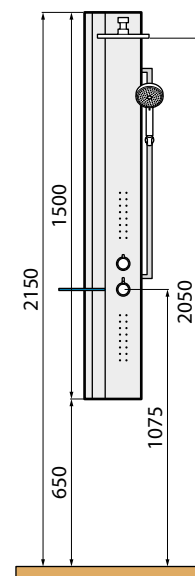
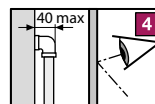
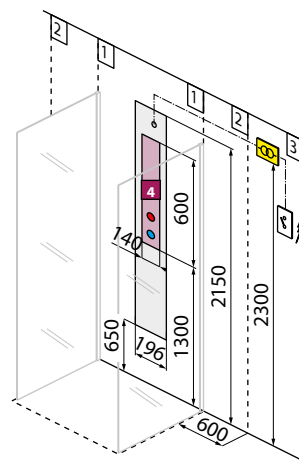
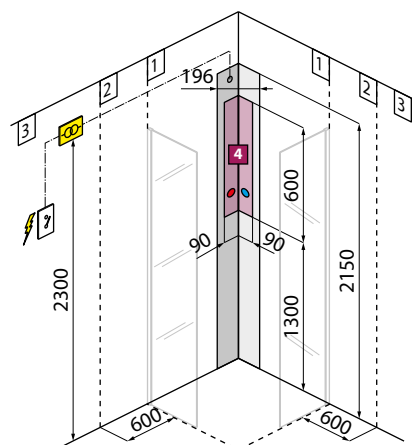

COLUMNAS
COLUNAS

Mezclador Misturadora	Medidas (cm)	Código	Selección de color / precio				Seleção de cores de acabados / Preço		
			Silver Abrillantado	Tortora	Plata Prata	Tortora	Negro mate	Negro mate	Blanco mate Branco mate
			Columnas blanco mate Columnas branco mate		columnas negro columnas negro		columnas plata columnas prata		columnas silver columnas brilhantado
			franja y repisa franja e prateleira		franja y repisa franja e prateleira		franja y repisa franja e prateleira		franja y repisa franja e prateleira
			UB	UN2	HJ	HN2	JH	BH	BU
			Silver Abrillantado	Tortora	Plata Prata	Tortora	Negro mate	Negro mate	Blanco mate Branco mate

1 2 Tomas para grifería



CARACTERÍSTICAS HIDRÁULICAS
CARACTERÍSTICAS HIDRÁULICAS

- Presión requerida 2÷5 bar
- Pressão requerida 2/5 bar
- Agua caliente 1/2"
- Água quente 1/2"
- Agua fría 1/2"
- Água fria 1/2"

STANDARD

Monomando Monocomando	22 x 7,5 x H150	LINE2M-	1.217 €	1.217 €	1.365 €	1.365 €	1.302 €	1.365 €	1.365 €
Termostático Termostática	22 x 7,5 x H150	LINE2T-	1.302 €	1.302 €	1.450 €	1.450 €	1.386 €	1.450 €	1.450 €

HIDROMASAJE / HIDROMASSAGEM

Monomando Monocomando	22 x 7,5 x H150	LINE2VM-	1.414 €	1.414 €	1.564 €	1.564 €	1.499 €	1.564 €	1.564 €
Termostático Termostática	22 x 7,5 x H150	LINE2VT-	1.499 €	1.499 €	1.648 €	1.648 €	1.584 €	1.648 €	1.648 €

LIGHT

Monomando Monocomando	22 x 7,5 x H150	LINE2VML-	1.753 €	1.753 €	1.903 €	1.903 €	1.838 €	1.903 €	1.903 €
Termostático Termostática	22 x 7,5 x H150	LINE2VTL-	1.838 €	1.838 €	1.988 €	1.988 €	1.923 €	1.988 €	1.988 €

CARACTERÍSTICAS ELÉCTRICAS
CARACTERÍSTICAS ELÉTRICAS

- 220-230 V
- 50/60 Hz
- Potencia nominal: 25 W

Antes de la instalación eléctrica de la columna, debe instalarse un diferencial de 30mA provisto de interruptor con ≥ 3 mm, de apertura mínima de los contactos.

Antes da instalação elétrica da cabine, deve instalar-se um diferencial de 30 mA provisto de interruptor com ≥ 3 mm de abertura mínima dos contatos.

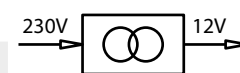

Construcción del código: **Código** + **Color Cores** = Código completo del producto
Construção do código: **Código** + **Color Cores** = Código completo do produto

REVIF PLUS

COLUMNA DE HIDROMASAJE DE ACERO INOX - PULIDO ESPEJO
COLUNA DE HIDROMASSAGEM DE AÇO INOX - PULIDO ESPELHO



Ducha fija de 200x200 mm
 Chuveiro fixo 200x200 mm

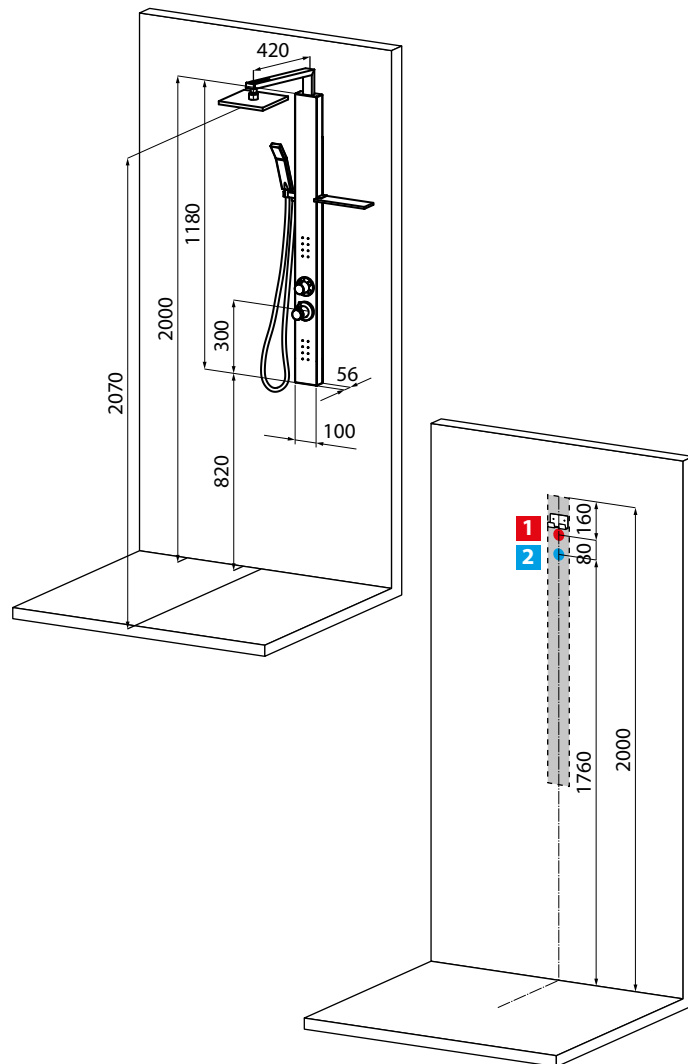

Mezclador Misturadora	Medidas (cm)	Código	Precio / Preço
--------------------------	--------------	--------	----------------

STANDARD CON HIDROMASAJE / HIDROMASSAGEM			
Monomando Monocomando	10 X H 118	REV1VM-K	984 €
Termostático Termostática	10 X H 118	REV1VT-K	1.065 €



1 2 Tomas para grifería

- 1** **CARACTERÍSTICAS HIDRÁULICAS**
CARACTERÍSTICAS HIDRÁULICAS
- 2** **CARACTERÍSTICAS HIDRÁULICAS**
- Presión requerida 2÷5 bar
 - Pressão requerida 2/5 bar
 - Agua caliente 1/2"
 - Água quente 1/2"
 - Agua fría 1/2"
 - Água fria 1/2"

REVIF

COLUMNA DE ACERO INOX - PULIDO ESPEJO
COLUNA DE AÇO INOX - PULIDO ESPELHO

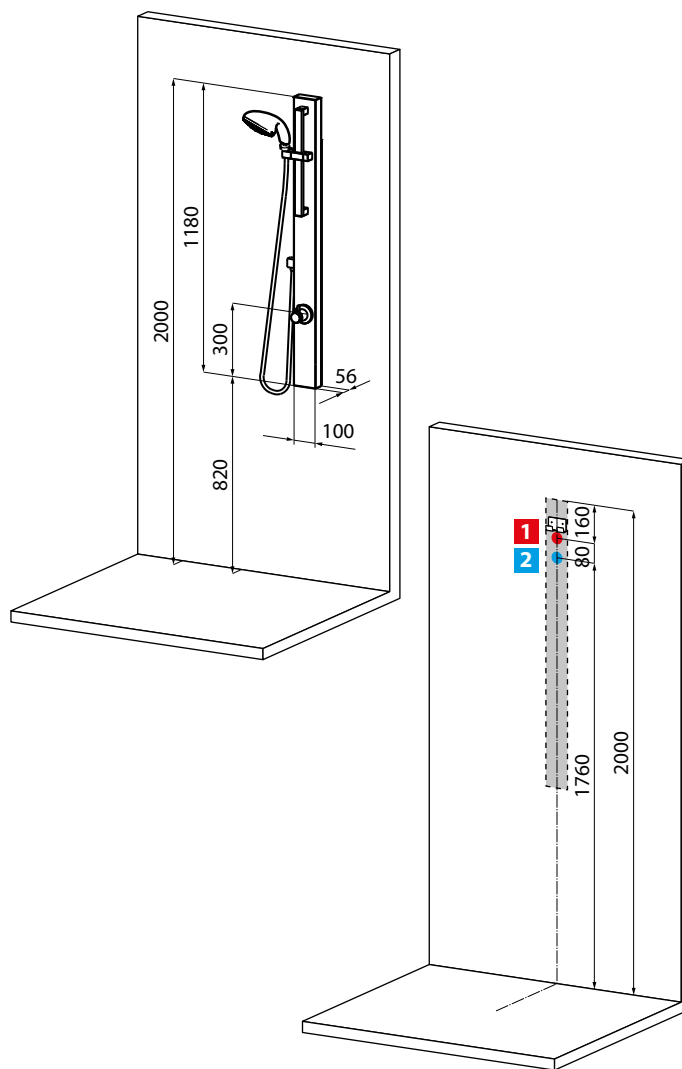

COLUMNAS
COLUNAS

Mezclador Misturadora	Medidas (cm)	Código	Precio / Preço
--------------------------	--------------	--------	----------------

Monomando Monocomando	10 X H 118	REV1M-K	615 €
Termostático Termostática	10 X H 118	REV1T-K	710 €



VANITY S

COLUMNA DE HIDROMASAJE
COLUNA DE HIDROMASSAGEM



Ducha fija de 200x200 mm
Chuveiro fixo 200x200 mm

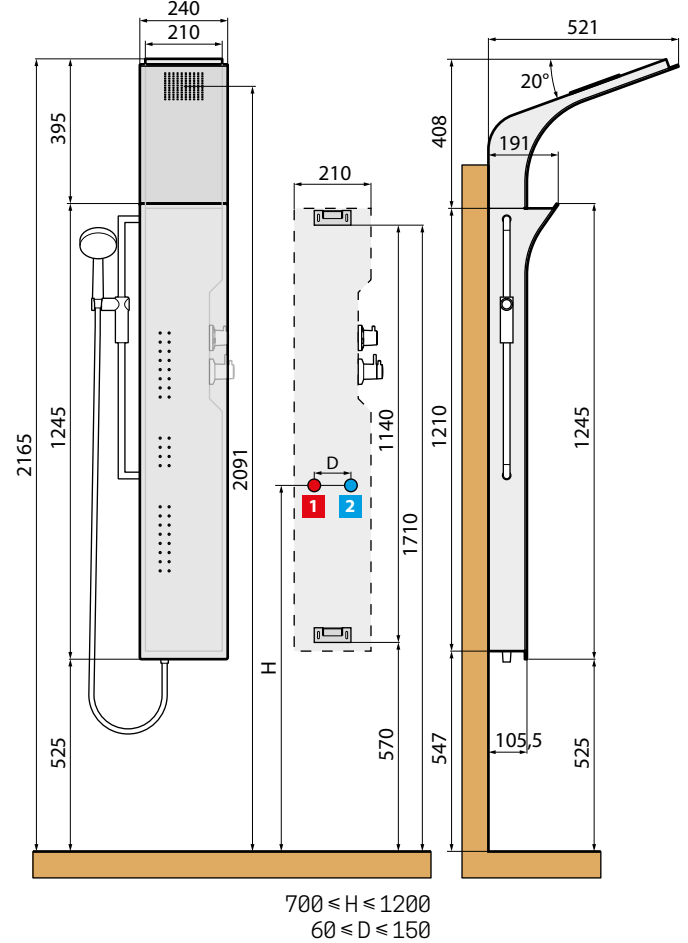

Mezclador Misturadora	Medidas (cm)	Código	Selección de color / precio Seleção de cores de acabados / Preço					
			A	U	I	M	N	V
			Blanco brillo Branco brilho	Blanco mate Branco mate	Blanco rayado Branco listrado	Grain	Burlington	wengue wengue

STANDARD								
Monomando Monocomando	24 x 52 x H 164	VANITY2MF-	1.488 €	1.530 €	1.571 €	1.571 €	1.571 €	1.571 €
Termostático Termostática	24 x 52 x H 164	VANITY2TF-	1.577 €	1.619 €	1.659 €	1.659 €	1.659 €	1.659 €
VERSIÓN HIDROMASAJE / VERSÃO HIDROMASSAGEM								
Monomando Monocomando	24 x 52 x H 164	VANITY2VMF-	1.679 €	1.721 €	1.764 €	1.764 €	1.764 €	1.764 €
Termostático Termostática	24 x 52 x H 164	VANITY2VTF-	1.767 €	1.809 €	1.852 €	1.852 €	1.852 €	1.852 €

1 2 Tomas para grifería

- 1** CARACTERÍSTICAS HIDRÁULICAS
CARACTERÍSTICAS HIDRÁULICAS
- 2** · Presión requerida 2÷5 bar
· Pressão requerida 2/5 bar
· Agua caliente 1/2"
· Água quente 1/2"
· Agua fría 1/2"
· Água fria 1/2"



COLUMNAS
COLUMNAS



- 363 Skill
- 371 Glax 2
- 383 Glax 1
- 395 Eon
- 409 Media Glass
- 417 Media
- 435 Revolution



CABINAS MULTIFUNCIÓN

LAS CABINAS
NOVELLINI TE
GARANTIZAN LA MÁS
INCREÍBLE EXPERIENCIA
EN LA DUCHA.

*A EXPERIÊNCIA MAIS
SURPREENDENTE
É GARANTIDA NAS
CABINES DE NOVELLINI.*

Confortables, funcionales y personalizables, estas fascinantes soluciones de diseño combinan el aspecto sofisticado con el aspecto multifuncional y multisensorial para satisfacer tus deseos de relajación. Fáciles de mantener y utilizar, las cabinas de ducha Novellini son únicas, exclusivas como quién las elige y permiten un excelente equilibrio en el baño, acorde a las exigencias de cada situación, a la personalización de cada estilo.

Confortáveis, funcionais e personalizáveis, estas soluções de design fascinantes combinam o aspecto sofisticado com o aspecto multifuncional e multissensorial para satisfazer o desejo de relaxamento. De fácil manutenção e uso, as cabinas Novellini são tão exclusivas quanto os que os escolhem e permitem um excelente gerenciamento do banheiro, satisfazendo as necessidades de reestruturação e estilos diferentes.



SKILL A 120X80 BLANCO MATE / BRANCO MATE



SKILL A 120X80 GRIS PERLA / CINZA PEROLA



SKILL DUAL AZUL BRILLO / AZUL BRILHO

SKILL | ACABADOS / ACABAMENTOS

ACABADO PERFILES / PERFIS



Blanco brillo
Branco brilho

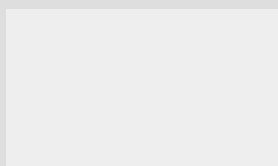

Blanco mate
Branco mate

CRISTAL / VIDRO



Transparente

ACABADOS PANELES MULTIFUNCIÓN

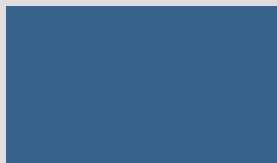

Azul brillo
Azul brilho
cod N0

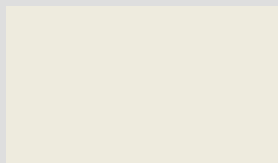

Blanco grisáceo
Branco cinza
cod N1

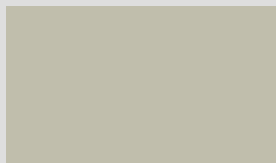

Gris tórtola
Cinza tortola
cod N2

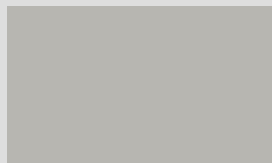

Gris perla
Cinza perola
cod N3

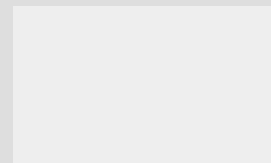

Blanco mate
Branco mate
cod U

SKILL | EQUIPAMIENTO Y FUNCIONES (disponibles según versión)



Grifería monomando o termostática /
Torneira monocomando ou termostática
Ducha de mano con flexo/
Chuveiro de mão com tubo flexível

Techo/Teto
Ducha fija tipo lluvia/ Duche fixo tipo chuva

Hidromasaje vertical y dorsal
Hidromassagem vertical e dorsal

Cascada
Cascata

Repisa porta objetos
Prateleira porta-objetos

Bluetooth

Asiento
Assento

Panel de mando electrónico soft-touch
Painel de comando electrónico soft-touch

Cromolight (hammam)
Iluminación interna LED (essential)
Iluminação interna LED (essential)

Sauna de Vapor + Jet de vapor con porta-esencia
Sauna de vapor + Jet de vapor com porta-essência

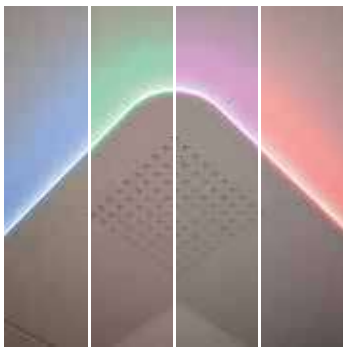

Sumérgete en un baño emocional de luz con Chromolight integrado en el techo de la cabina.

Mergulhe em um banho de luz emocional com o Chromolight embutido no tecto.

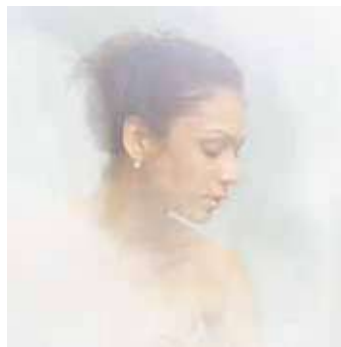

Envuelve tu cuerpo con una suave nube de vapor y aromas de aceites esenciales.

Envolve o corpo com uma nuvem suave de vapor e aromas de óleos essenciais.



Panel de Control simple y seguro
Painel de controle simples e seguro



Asiento plegable para adaptarse a todos los usos de la cabina.
Assento dobrável para se adaptar a todos os usos da cabine.

SKILL

SKILL



SKILL DUAL



CABINA MULTIFUNCIÓN PARA DOS PERSONAS Y SAUNA DE VAPOR, MAMPARA DE APERTURA CORREDERA COMPUESTA POR DOS FIJOS Y DOS PUERTAS CENTRALES MÁS DOS PANELES FIJOS LATERALES

CABINE MULTIFUNÇÃO PARA DUAS PESSOAS E SAUNA DE VAPOR, RESGUARDO COMPOSTO DE DUAS PORTAS DE CORRER CENTRAIS E DOIS PAINÉIS FIXOS LATERAIS

Design Marco Pellici

Medidas				Código	instalación		Mezclador Misturadora	cristal vidro	Selección de color Seleção de cores de acabados								
					D	S			Acabado blanco brillo Acabado branco brilho				Acabado blanco mate Acabado branco mate				
Medidas	plato de ducha bases de chuveiro	altura cabina altura da cabine(cm)	Entrada		D	S	T	1	AN0	AN1	AN2	AN3	UN0	UN1	UN2	UN3	UU
	C		*		Dere- cha Direita	Izquierda Esquer- da	Termo- stático Termo- stática	Transpa- rente	Azul brillo Azul brilho	Blanco grisáceo Branco cinza	Tortora	Perla	Azul brillo Azul brilho	Blanco grisáceo Branco cinza	Tortora	Perla	Blanco mate Branco mate
HAMMAM INSTALACIÓN A UNA SOLA PARED HAMMAM INSTALAÇÃO CENTRO DE PAREDE																	
					D	S	T5-	1	AN0	AN1	AN2	AN3	UN0	UN1	UN2	UN3	UU
160 x 97	H 4,5	211	62	SK12A160	-	-			13.279 €	13.279 €	13.279 €	13.279 €	13.646 €	13.646 €	13.646 €	13.646 €	13.646 €
160 x 97	H 12,5	219	62	SK12A169	-	-			13.279 €	13.279 €	13.279 €	13.279 €	13.646 €	13.646 €	13.646 €	13.646 €	13.646 €
HAMMAM INSTALACIÓN ANGULAR HAMMAM INSTALAÇÃO ANGULADA																	
					D	S	T5-	1	AN0	AN1	AN2	AN3	UN0	UN1	UN2	UN3	UU
160 x 97	H 4,5	211	62	SK12A160					13.279 €	13.279 €	13.279 €	13.279 €	13.646 €	13.646 €	13.646 €	13.646 €	13.646 €
160 x 97	H 12,5	219	62	SK12A169					13.279 €	13.279 €	13.279 €	13.279 €	13.646 €	13.646 €	13.646 €	13.646 €	13.646 €





SKILL

SKILL DUAL GRIS PERLA / CINZA PEROLA

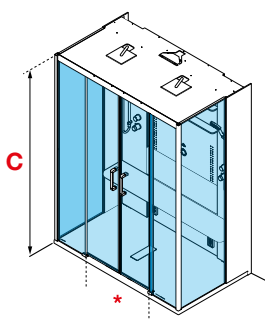

S Izquierda
Esquerda

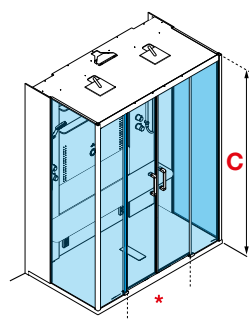

D Derecha
Direita

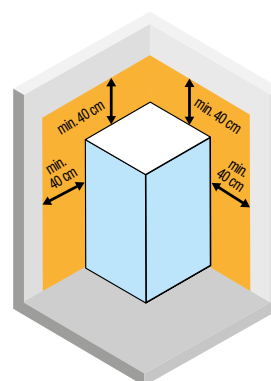
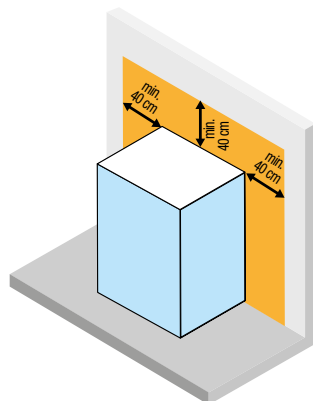

SE DEBE GARANTIZAR
LA RENOVACIÓN DE
AIRE EN EL BAÑO.
DEVE-SE GARANTIR A
RENOVAÇÃO DE AR NA
SALA DE BANHO

CABINA MULTIFUNCIÓN - MAMPARA EN ÁNGULO FORMADA POR DOS FIJOS Y DOS PUERTAS CORREDERAS DE ENTRADA POR EL ÁNGULO

CABINE MULTIFUNÇÃO - RESGUARDO ASSIMÉTRICO COMPUESTO POR DOIS FIXOS E DUAS PORTAS DE CORRER ABERTURA VÉRTICE

Design Marco Pellici

Medidas				Código	instalación		Mezclador Misturadora		cristal vidro	Selección de color Seleção de cores de acabados								
										Acabado blanco brillo Acabado branco brilho				Acabado blanco mate Acabado branco mate				
Medidas	plato de ducha bases de chuveiro	altura cabina altura da cabine(cm)	Entrada		D	S	M	T	1	AN0	AN1	AN2	AN3	UN0	UN1	UN2	UN3	UU
			C *		Derecha Direita	Izquierda Esquerda	Mono- mando Monoco- mando	Termo- stático Termo- stática	Transpa- rente	Azul brillo Azul brilho	Blanco grisáceo Branco cinza	Tortora	Perla	Azul brillo Azul brilho	Blanco grisáceo Branco cinza	Tortora	Perla	Blanco mate Branco mate

ESSENTIAL

				D	S	M1F-	T1F-	1	AN0	AN1	AN2	AN3	UN0	UN1	UN2	UN3	UU
100 x 80	H 4,5	209,5	44						6.294 €	6.294 €	6.294 €	6.294 €	6.622 €	6.622 €	6.622 €	6.622 €	6.622 €
100 x 80	H 12,5	217,5	44														
120 x 80	H 4,5	209,5	51						6.570 €	6.570 €	6.570 €	6.570 €	6.897 €	6.897 €	6.897 €	6.897 €	6.897 €
120 x 80	H 12,5	217,5	51														
120 x 90	H 4,5	209,5	54				+ 143 €		6.924 €	6.924 €	6.924 €	6.924 €	7.250 €	7.250 €	7.250 €	7.250 €	7.250 €
120 x 90	H 12,5	217,5	54														
120 x 100	H 4,5	209,5	58						7.291 €	7.291 €	7.291 €	7.291 €	7.618 €	7.618 €	7.618 €	7.618 €	7.618 €
120 x 100	H 12,5	217,5	58														

HAMMAM

				D	S	M5-	T5-	1	AN0	AN1	AN2	AN3	UN0	UN1	UN2	UN3	UU
100 x 80	H 4,5	211	44						7.566 €	7.566 €	7.566 €	7.566 €	7.894 €	7.894 €	7.894 €	7.894 €	7.894 €
100 x 80	H 12,5	219	44														
120 x 80	H 4,5	211	51						7.842 €	7.842 €	7.842 €	7.842 €	8.169 €	8.169 €	8.169 €	8.169 €	8.169 €
120 x 80	H 12,5	219	51														
120 x 90	H 4,5	211	54				+ 143 €		8.194 €	8.194 €	8.194 €	8.194 €	8.521 €	8.521 €	8.521 €	8.521 €	8.521 €
120 x 90	H 12,5	219	54														
120 x 100	H 4,5	211	58						8.563 €	8.563 €	8.563 €	8.563 €	8.890 €	8.890 €	8.890 €	8.890 €	8.890 €
120 x 100	H 12,5	219	58														



SKILL A GRIS PERLA / CINZA PEROLA

SKILL

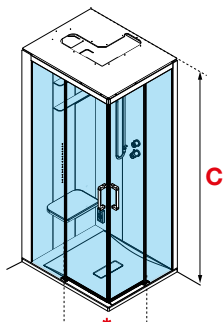

S Izquierda
Esquerda

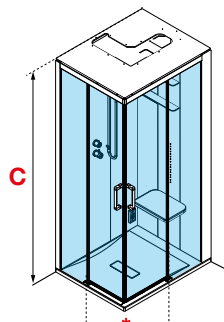

D Derecha
Direita

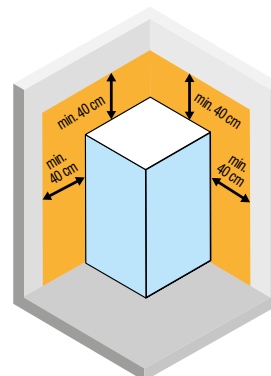

**SE DEBE GARANTIZAR
LA RENOVACIÓN DE
AIRE EN EL BAÑO.
DEVE-SE GARANTIR A
RENOVAÇÃO DE AR NA
SALA DE BANHO**

SKILL 2P



CABINA MULTIFUNCIÓN: MAMPARA COMPUESTA POR UN FRONTAL DE FIJO Y PUERTA CORREDERA MÁS UN FIJO LATERAL
CABINE MULTIFUNÇÃO RESGUARDO COMPOSTO POR UM FRONTAL DA FIXO E PORTA DA CORRER E PAINEL FIXO LATERAL
 Design Marco Pellici

Medidas				Código	instalación		Mezclador Misturadora		cristal vidro	Selección de color Seleção de cores de acabados								
										Acabado blanco brillo Acabado branco brilho				Acabado blanco mate Acabado branco mate				
Medidas	plato de ducha bases de chuveiro	altura cabina altura da cabine(cm)	Entrada		D	S	M	T	1	AN0	AN1	AN2	AN3	UN0	UN1	UN2	UN3	UU
			C			*												
					Derecha Direita	Izquierda Esquerda	Mono- mando Monoco- mando	Termo- stático Termo- stática	Transpa- rente	Azul brillo Azul brilho	Blanco grisáceo Branco cinza	Tortora	Perla	Azul brillo Azul brilho	Blanco grisáceo Branco cinza	Tortora	Perla	Blanco mate Branco mate
ESSENTIAL																		
					D	S	M1F-	T1F-	1	AN0	AN1	AN2	AN3	UN0	UN1	UN2	UN3	UU
140 x 80	H 4,5	209,5	55	SKI2P140				+ 143 €		7.296 €	7.296 €	7.296 €	7.296 €	7.624 €	7.624 €	7.624 €	7.624 €	7.624 €
140 x 80	H 12,5	217,5	55	SKI2P149														
HAMMAM																		
					D	S	M5-	T5-	1	AN0	AN1	AN2	AN3	UN0	UN1	UN2	UN3	UU
140 x 80	H 4,5	209,5	55	SKI2P140				+ 143 €		8.565 €	8.565 €	8.565 €	8.565 €	8.892 €	8.892 €	8.892 €	8.892 €	8.892 €
140 x 80	H 12,5	217,5	55	SKI2P149														



SKILL

SKILL 2P GRIS PERLA / CINZA PEROLA

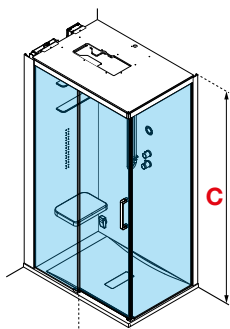

S Izquierda
Esquerda

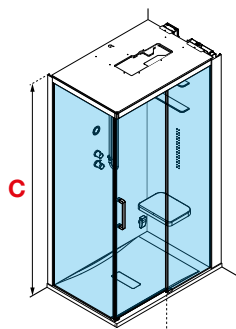

D Derecha
Direita

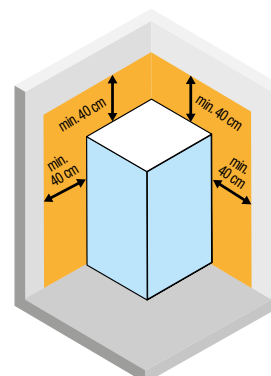

SE DEBE GARANTIZAR
LA RENOVACIÓN DE
AIRE EN EL BAÑO.
DEVE-SE GARANTIR A
RENOVAÇÃO DE AR NA
SALA DE BANHO



WHITE



TOTAL WHITE



BLACK



SILVER



CORDA

GLAX 2 | ACABADOS / ACABAMENTOS

	COLORES PERFILES / CORES PERFIS	TIRADOR	COLUMNAS / COLUNAS	PARED CABINA / PAREDE CABINE	PLATO / BASE	TECHO / TECTO *	ASIENTO / ASSENTO *
WHITE	Negro	Negro	Blanco/ Branco	Negro	Blanco/ Branco	Blanco/ Branco	Blanco/ Branco
TOTAL WHITE	Blanco/ Branco	Blanco/ Branco	Blanco/ Branco	Blanco/ Branco	Blanco/ Branco	Blanco/ Branco	Blanco/ Branco
BLACK	Blanco/ Branco	Blanco/ Branco	Negro	Blanco/ Branco	Negro mate	Negro	Blanco/ Branco
SILVER/ ABRILLANTADO	Silver / Abrillantado	Cromo	Silver / Abrillantado	Blanco/ Branco	Blanco / Branco brillo	Blanco/ Branco	Blanco/ Branco
CORDA	Blanco/ Branco	Blanco/ Branco	Corda	Blanco/ Branco	Corda mate	Corda	Blanco/ Branco

* disponible según el modelo
disponível de acordo com o modelo

GLAX 2 | EQUIPAMIENTO Y FUNCIONES (disponibles según versión)



Grifería monomando o termostática /
Torneira monocomando ou termostática
Ducha de mano con flexo/
Chuveiro de mão com tubo flexível

Techo/Teto
Ducha fija tipo lluvia/ Duche fixo tipo chuva

Hidromasaje vertical y dorsal
Hidromassagem vertical e dorsal

Repisa porta objetos
Prateleira porta-objetos

Bluetooth

Asiento
Assento

Panel de mando electrónico soft-touch
Painel de comando electrónico soft-touch

Cromolight (hammam)
Iluminación interna LED (essential)
Iluminação interna LED (essential)

Sauna de Vapor + Jet de vapor con porta-
essencia
Sauna de vapor + Jet de vapor com porta-
essência



GLAX 2 2.0 2P CORDA



Diseño limpio y contemporáneo, con grandes superficies acristaladas y poca perfilaría. El techo de cristal se integra en el propio espesor de los perfiles.
Design limpo e contemporâneo com grandes superfícies de vidro e pouco perfil.
O telhado de vidro é integrado na espessura dos perfis.



La luz LED blanca o en versión Cromolight se integra de forma elegante en la columna.
Luz LED branca ou com programação Cromolight elegantemente integrada na coluna.



Hidromasaje vertical relajante y tonificante.
Hidromassagem vertical relaxante e revigorante.



Sauna de vapor con difusor de aroma: una experiencia para los sentidos.
Sauna a vapor com difusor de aromas uma experiência para os sentidos.

GLAX 2



GLAX 2

GLAX 2 2P



CABINA MULTIFUNCIÓN: MAMPARA COMPUESTA POR UN FRONTAL DE FIJO Y PUERTA CORREDERA MÁS UN FIJO LATERAL
CABINE MULTIFUNÇÃO RESGUARDO COMPOSTO POR UM FRONTAL DA FIXO E PORTA DA CORRER E PAINEL FIXO LATERAL

Design Marco Pellici

Medidas				Código	instalación		Mezclador Misturadora		cristal vidro	Selección de color Seleção de cores de acabados					
Medidas (cm.)	plato de ducha bases de chuveiro	altura cabina altura da cabine(cm)	Entrada		D	S	M	T		1	UH	UU	HU	BB	TU
		C	*			Derecha Direita	Izquierda Esquerda	Monomando Monocomando	Termostático Termostática	Transparente	White	Total White	Black	Silver Abrillantado	Corde
HYDRO															
					D	S	M1-	T1-	1	UH	UU	HU	BB	TU	
120 X 80	4,5	217	49	G222P120						4.095 €	3.713 €	4.519 €	4.519 €	4.519 €	
120 X 80	11,5	224	49	G222P129											
140 X 80	4,5	217	60	G222P140						4.577 €	4.181 €	5.013 €	5.013 €	5.013 €	
140 X 80	12,5	225	60	G222P149											
120 X 90	4,5	217	49	G222P290				+ 98 €		4.245 €	3.850 €	4.682 €	4.682 €	4.682 €	
120 X 90	11,5	224	49	G222P299											
140 X 90	4,5	217	60	G222P490						4.722 €	4.327 €	5.159 €	5.159 €	5.159 €	
140 X 90	12,5	225	60	G222P499											
HYDRO PLUS															
					D	S	M1L-	T1L-	1	UH	UU	HU	BB	TU	
120 X 80	4,5	217	49	G222P120						4.545 €	4.122 €	5.011 €	5.011 €	5.011 €	
120 X 80	11,5	224	49	G222P129											
140 X 80	4,5	217	60	G222P140						5.028 €	4.590 €	5.511 €	5.511 €	5.511 €	
140 X 80	12,5	225	60	G222P149											
120 X 90	4,5	217	49	G222P290				+ 98 €		4.696 €	4.259 €	5.180 €	5.180 €	5.180 €	
120 X 90	11,5	224	49	G222P299											
140 X 90	4,5	217	60	G222P490						5.173 €	4.736 €	5.657 €	5.657 €	5.657 €	
140 X 90	12,5	225	60	G222P499											
HAMMAM															
					D	S	M5-	T5-	1	UH	UU	HU	BB	TU	
120 X 80	4,5	217	49	G222P120						5.297 €	4.805 €	5.835 €	5.835 €	5.835 €	
120 X 80	11,5	224	49	G222P129											
140 X 80	4,5	217	60	G222P140						5.777 €	5.272 €	6.337 €	6.337 €	6.337 €	
140 X 80	12,5	225	60	G222P149											
120 X 90	4,5	217	49	G222P290				+ 98 €		5.446 €	4.942 €	6.005 €	6.005 €	6.005 €	
120 X 90	11,5	224	49	G222P299											
140 X 90	4,5	217	60	G222P490						5.923 €	5.419 €	6.482 €	6.482 €	6.482 €	
140 X 90	12,5	225	60	G222P499											



GLAX 2

GLAX 2 2.0 2P CORDA

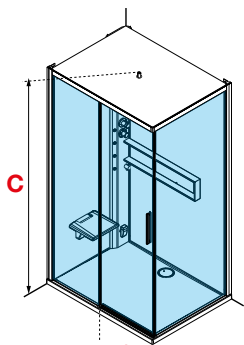

S Izquierda
Esquerda

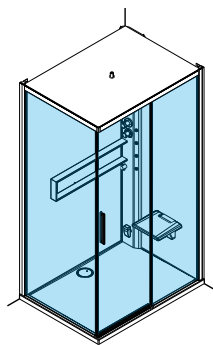

D Derecha
Direita

CABINA MULTIFUNCIÓN: MAMPARA COMPUESTA POR DOS FIJOS Y DOS CORREDERAS DE APERTURA EN VÉRTICE
CABINE MULTIFUNÇÃO - RESGUARDO COMPUESTO POR DOIS FIXOS E DUAS PORTAS DE CORRER ABERTURA VÉRTICE

Design Marco Pellici

Medidas				Código	instalación		Mezclador Misturadora		cristal vidro	Selección de color Seleção de cores de acabados				
Medidas (cm.)	plato de ducha bases de chuveiro	altura cabina altura da cabine(cm)	Entrada		D	S	M	T	1	UH	UU	HU	BB	TU
					Derecha Direita	Izquierda Esquerda	Monomando Monocomando	Termostático Termostática	Transparente	White	Total White	Black	Silver Abrillantado	Corda
				C										
HYDRO														
					D	S	M1-	T1-	1	UH	UU	HU	BB	TU
80 X 80	4,5	217	40	G22A80	-	-				3.795 €	3.440 €	4.184 €	4.184 €	4.184 €
80 X 80	11,5	224	40	G22A89	-	-								
90 X 90	4,5	217	47	G22A90	-	-				3.871 €	3.509 €	4.272 €	4.272 €	4.272 €
90 X 90	11,5	224	47	G22A99	-	-								
100 X 100	4,5	217	54	G22A100	-	-				3.945 €	3.576 €	4.354 €	4.354 €	4.354 €
100 X 100	11,5	224	54	G22A109	-	-								
90 X 70	4,5	217	40	G22A9070				+ 98 €		3.795 €	3.440 €	4.184 €	4.184 €	4.184 €
90 X 70	11,5	224	40	G22A9079										
100 X 70	4,5	217	43,5	G22A107						3.871 €	3.509 €	4.272 €	4.272 €	4.272 €
100 X 70	11,5	224	43,5	G22A197										
100 X 80	4,5	217	47,5	G22A108						3.945 €	3.576 €	4.354 €	4.354 €	4.354 €
100 X 80	11,5	224	47,5	G22A198										
HYDRO PLUS														
					D	S	M1L-	T1L-	1	UH	UU	HU	BB	TU
80 X 80	4,5	217	40	G22A80	-	-				4.245 €	3.850 €	4.682 €	4.682 €	4.682 €
80 X 80	11,5	224	40	G22A89	-	-								
90 X 90	4,5	217	47	G22A90	-	-				4.320 €	3.919 €	4.764 €	4.764 €	4.764 €
90 X 90	11,5	224	47	G22A99	-	-								
100 X 100	4,5	217	54	G22A100	-	-				4.396 €	3.986 €	4.846 €	4.846 €	4.846 €
100 X 100	11,5	224	54	G22A109	-	-								
90 X 70	4,5	217	40	G22A9070				+ 98 €		4.245 €	3.850 €	4.682 €	4.682 €	4.682 €
90 X 70	11,5	224	40	G22A9079										
100 X 70	4,5	217	43,5	G22A107						4.320 €	3.919 €	4.764 €	4.764 €	4.764 €
100 X 70	11,5	224	43,5	G22A197										
100 X 80	4,5	217	47,5	G22A108						4.396 €	3.986 €	4.846 €	4.846 €	4.846 €
100 X 80	11,5	224	47,5	G22A198										
HAMMAM														
					D	S	M5-	T5-	1	UH	UU	HU	BB	TU
80 X 80	4,5	217	40	G22A80	-	-				4.996 €	4.532 €	5.509 €	5.509 €	5.509 €
80 X 80	11,5	224	40	G22A89	-	-								
90 X 90	4,5	217	47	G22A90	-	-				5.071 €	4.600 €	5.589 €	5.589 €	5.589 €
90 X 90	11,5	224	47	G22A99	-	-								
100 X 100	4,5	217	54	G22A100	-	-				5.146 €	4.668 €	5.671 €	5.671 €	5.671 €
100 X 100	11,5	224	54	G22A109	-	-								
90 X 70	4,5	217	40	G22A9070				+ 98 €		4.996 €	4.532 €	5.509 €	5.509 €	5.509 €
90 X 70	11,5	224	40	G22A9079										
100 X 70	4,5	217	43,5	G22A107						5.071 €	4.600 €	5.589 €	5.589 €	5.589 €
100 X 70	11,5	224	43,5	G22A197										
100 X 80	4,5	217	47,5	G22A108						5.146 €	4.668 €	5.671 €	5.671 €	5.671 €
100 X 80	11,5	224	47,5	G22A198										



GLAX 2

GLAX 2.0 A TOTAL WHITE

80x80 | 90x90 | 100x100

90x70 | 100x70 | 100x80

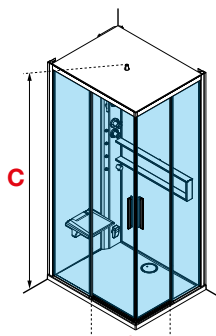
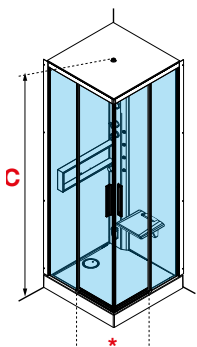

S Izquierda
Esquerda

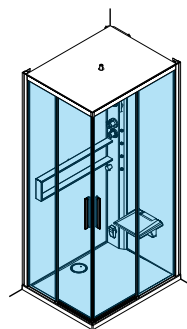

D Derecha
Direita

GLAX 2 G+F



CABINA MULTIFUNCIÓN: MAMPARA COMPUESTA POR UNA PUERTA ABATIBLE Y UN FIJO LATERAL
CABINE MULTIFUNCIONAL: MOMPARA COMPOSTA POR UMA PORTA DOBRADA E UM LADO FIXO

Design Marco Pellici

Medidas				Código	instalación		Mezclador Misturadora		cristal vidrio	Selección de color Seleção de cores de acabados				
Medidas (cm.)	plato de ducha bases de chuveiro	altura cabina altura da cabine(cm)	Entrada		D	S	M	T		1	UH	UU	HU	BB
		C	*		Derecha Direita	Izquierda Esquerda	Monomando Monocomando	Termostático Termostática	Transparente	White	Total White	Black	Silver Abrillantado	Corde
HYDRO														
					D	S	M1-	T1-	1	UH	UU	HU	BB	TU
80 X 80	4,5	217	61	G22GF80						3.795 €	3.440 €	4.184 €	4.184 €	4.184 €
80 X 80	11,5	224	61	G22GF89				+ 98 €						
90 X 90	4,5	217	71	G22GF90						3.871 €	3.509 €	4.272 €	4.272 €	4.272 €
90 X 90	11,5	224	71	G22GF99										
HYDRO PLUS														
					D	S	M1L-	T1L-	1	UH	UU	HU	BB	TU
80 X 80	4,5	217	61	G22GF80						4.245 €	3.850 €	4.682 €	4.682 €	4.682 €
80 X 80	11,5	224	61	G22GF89				+ 98 €						
90 X 90	4,5	217	71	G22GF90						4.320 €	3.919 €	4.764 €	4.764 €	4.764 €
90 X 90	11,5	224	71	G22GF99										
HAMMAM														
					D	S	M5-	T5-	1	UH	UU	HU	BB	TU
80 X 80	4,5	217	61	G22GF80						4.996 €	4.532 €	5.509 €	5.509 €	5.509 €
80 X 80	11,5	224	61	G22GF89				+ 98 €						
90 X 90	4,5	217	71	G22GF90						5.071 €	4.600 €	5.589 €	5.589 €	5.589 €
90 X 90	11,5	224	71	G22GF99										



GLAX 2

GLAX 2.0 G WHITE

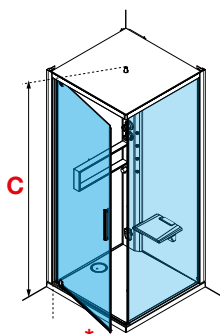

S Izquierda
Esquerda

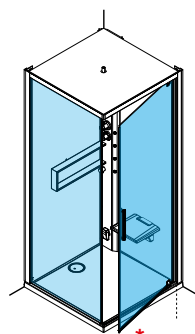

D Derecha
Direita

CABINA MULTIFUNCIÓN: MAMPARA SEMICIRCULAR COMPUESTA POR DOS FIJOS Y DOS PUERTAS CORREDERAS CENTRALES
RESGUARDO PARA BASE SEMICIRCULAR COMPUESTO POR DUAS PORTAS DE CORRER E DOIS FIXOS

Design Marco Pellici

Medidas				Código	Mezclador Misturadora		crystal vidro	Selección de color Seleção de cores de acabados				
Medidas (cm.)	plato de ducha bases de chuveiro	altura cabina altura da cabine(cm)	Entrada		M	T	1	UH	UU	HU	BB	TU
					Monomando Monocomando	Termostático Termostática	Transparente	White	Total White	Black	Silver Abrillantado	Corde
		C	*									
HYDRO												
					M1-	T1-	1	UH	UU	HU	BB	TU
90 X 90	4,5	217	49	G22R90				4.396 €	3.986 €	4.846 €	4.846 €	4.846 €
90 X 90	11,5	224	49	G22R99		+ 98 €						
100 X 100	4,5	217	49	G22R100				4.545 €	4.122 €	5.011 €	5.011 €	5.011 €
100 X 100	11,5	224	49	G22R109								
HYDRO PLUS												
					M1L-	T1L-	1	UH	UU	HU	BB	TU
90 X 90	4,5	217	49	G22R90				4.846 €	4.396 €	5.345 €	5.345 €	5.345 €
90 X 90	11,5	224	49	G22R99		+ 98 €						
100 X 100	4,5	217	49	G22R100				4.996 €	4.532 €	5.509 €	5.509 €	5.509 €
100 X 100	11,5	224	49	G22R109								
HAMMAM												
					M5-	T5-	1	UH	UU	HU	BB	TU
90 X 90	4,5	217	49	G22R90				5.596 €	5.077 €	6.169 €	6.169 €	6.169 €
90 X 90	11,5	224	49	G22R99		+ 98 €						
100 X 100	4,5	217	49	G22R100				5.747 €	5.214 €	6.334 €	6.334 €	6.334 €
100 X 100	11,5	224	49	G22R109								



GLAX 2.0 R SILVER

GLAX 2

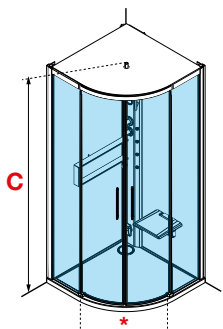

GLAX 2 A+F



CABINA MULTIFUNCIÓN A PARED, COMPUESTA POR UN PANEL FIJO LATERAL Y UNA MAMPARA ANGULAR DE ENTRADA EN EL VÉRTICE
CABINE MULTIFUNÇÃO Á PAREDE, FORMADA POR UM PAINEL FIXO LATERAL E UM RESGUARDO DE CORRER DE CANTO.



OPCIONAL



Asiento en material acrílico opaco
Assento em material acrílico opaco

Código	Precio / Preço
SED030PL	391 €

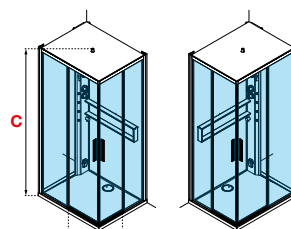

S Izquierda
Esquerda

D Derecha
Direita

Medidas				Código	instalación		Mezclador Misturadora		cristal vidro	Selección de color Seleção de cores de acabados				
Medidas (cm.)	plato de ducha bases de chuveiro	altura cabina altura da cabine(cm)	Entrada		D	S	M	T		1	UH	UU	HU	BB
		C	*		Derecha Direita	Izquierda Esquerda	Monomando Monocomando	Termostático Termostática	Transpa- rente	White	Total White	Black	Silver Abrillantado	Corda

HYDRO

				D	S	M1-	T1-	1	UH	UU	HU	BB	TU	
100 X 80	4,5	217	47,5	G22AF108						4.142 €	3.756 €	4.573 €	4.573 €	4.573 €
100 X 80	11,5	224	47,5	G22AF198				+ 98 €						

HYDRO PLUS

				D	S	M1L-	T1L-	1	UH	UU	HU	BB	TU	
100 X 80	4,5	217	47,5	G22AF108						4.615 €	4.186 €	5.088 €	5.088 €	5.088 €
100 X 80	11,5	224	47,5	G22AF198				+ 98 €						

HAMMAM

				D	S	M5-	T5-	1	UH	UU	HU	BB	TU	
100 X 80	4,5	217	47,5	G22AF108						5.405 €	4.903 €	5.955 €	5.955 €	5.955 €
100 X 80	11,5	224	47,5	G22AF198				+ 98 €						

GLAX 2 2P+2F



CABINA MULTIFUNCIÓN, COMPUESTA POR DOS PANELES FIJOS LATERALES Y UNA MAMPARA FRONTAL DE FIJO Y PUERTA CORREDERA
CABINE MULTIFUNÇÃO À PAREDE, FORMADA POR DOIS PAINÉIS FIXOS LATERAIS E UM RESGUARDO FRONTAL DE PORTA DE CORRER



OPCIONAL



Asiento en material acrílico opaco
Assento em material acrílico opaco

Código	Precio / Preço
SED030PL	391 €

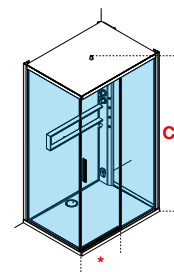

Medidas				Código	Mezclador Misturadora		cristal vidro	Selección de color Seleção de cores de acabados				
Medidas (cm.)	plato de ducha bases de chuveiro	altura cabina altura da cabine(cm)	Entrada		M	T		1	UH	UU	HU	BB
		C	*		Monomando Monocomando	Termostático Termostática	Transparente	White	Total White	Black	Silver Abrilantado	Corda

HYDRO												
				M1-	T1-	1	UH	UU	HU	BB	TU	
120 X 80	4,5	217	49	G222PF120			4.300 €	3.900 €	4.746 €	4.746 €	4.746 €	
120 X 80	11,5	224	49	G222PF129	+ 98 €							

HYDRO PLUS												
				M1L-	T1L-	1	UH	UU	HU	BB	TU	
120 X 80	4,5	217	49	G222PF120			4.773 €	4.329 €	5.262 €	5.262 €	5.262 €	
120 X 80	11,5	224	49	G222PF129	+ 98 €							

HAMMAM												
				M5-	T5-	1	UH	UU	HU	BB	TU	
120 X 80	4,5	217	49	G222PF120			5.562 €	5.046 €	6.129 €	6.129 €	6.129 €	
120 X 80	11,5	224	49	G222PF129	+ 98 €							

Construcción del código: **Código** + **Mezclador Misturadora** + **Cristal Vidro** + **Perfiles Perfis** = Código completo del producto
 Construção do código: **Código** + **Misturadora** + **Vidro** + **Perfis** = Código completo do produto

WHITE



BLACK



SILVER



GLAX 1 | ACABADOS / ACABAMENTOS

	PERFILES PERFIS	TIRADOR	COLUMNAS COLUNAS	JABONERA SABONETEIRA	PARED CABINA PAREDE CABINE	PLATO BASE	TECHO TECTO *	ASIENTO ASSENTO *
WHITE	Blanco Branco mate	Blanco Branco mate	Blanco Branco mate	Blanco Branco mate	Blanco Branco	Blanco Branco brillo	Blanco Branco mate	Blanco Branco
BLACK	Negro mate	Negro mate	Negro mate	Negro mate	Blanco Branco	Blanco Branco brillo	Blanco Branco mate	Blanco Branco
SILVER	Silver Abrillantado	Cromo	Silver Abrillantado	Cromo	Blanco Branco	Blanco Branco brillo	Blanco Branco mate	Blanco Branco

* disponible según el modelo
disponível de acordo com o modelo

GLAX 1 | EQUIPAMIENTO Y FUNCIONES (disponibles según versión)

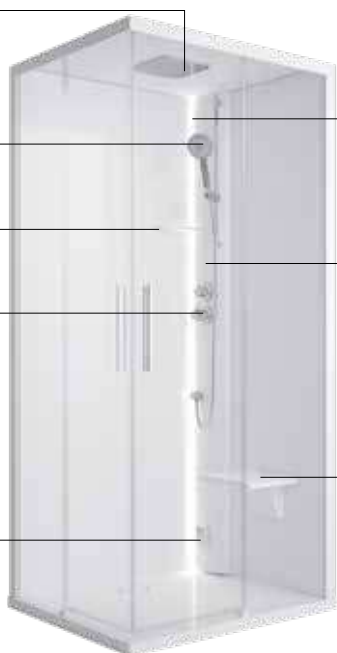

Grifería monomando o termostática /
Torneira monocomando ou termostática
Ducha de mano con flexo/
Chuveiro de mão com tubo flexível

Techo/Teto
Ducha fija tipo lluvia/ Duche fixo tipo chuva

Repisa porta objetos
Prateleira porta-objects

Bluetooth

Asiento
Assento

Panel de mando electrónico soft-touch
Painel de comando electrónico soft-touch

Cromolight (hammam)
Iluminación interna LED (essential)
Iluminação interna LED (essential)

Sauna de Vapor + Jet de vapor con porta-
essencia
Sauna de vapor + Jet de vapor com porta-
essência



GLAX 1 2P WHITE

GLAX 1



Diseño limpio y contemporáneo, con grandes superficies acristaladas y poca perfilería. El techo de cristal se integra en el propio espesor de los perfiles. *Design limpo e contemporâneo com grandes superfícies de vidro e pouco perfil. O tecto de vidro é integrado na espessura dos perfis.*



Asiento reclinable
Assento reclinável



La luz LED blanca o en versión Cromolight se integra de forma elegante en la columna. *Luz LED branca ou com programação Cromolight elegantemente integrada na coluna.*



Sauna de vapor con difusor de aroma: una experiencia para los sentidos. *Sauna a vapor com difusor de aromas uma experiência para os sentidos.*

GLAX 1



GLAX 1 2P



200 cm
6 mm
puerta/
porta
5 mm

CABINA DE DUCHA - MAMPARA COMPUESTA POR UN FRONTAL DE FIJO Y PUERTA CORREDERA MÁS UN FIJO LATERAL

CABINE DUCHA RESGUARDO COMPOSTO POR UM FRONTAL DA FIXO E PORTA DA CORRER E PAINEL FIXO LATERAL

Design Marco Pellici

Medidas				Código	instalación		Mezclador Misturadora		cristal vidro	Selección de color Seleção de cores de acabados		
Medidas (cm.)	plato de ducha bases de chuveiro	altura cabina altura da cabine(cm)	Entrada		D	S	M	T		1	UU	HH
		C	*		Derecha Direita	Izquierda Esquerda	Monomando Monocomando	Termostático Termostática	Transparente	White	Black	Silver Abrillantado
STANDARD												
					D	S	M-	T-	1	UU	HH	BB
120 X 80	4,5	210	49	G212P120						2.758 €	3.044 €	3.044 €
120 X 80	11,5	217	49	G212P129								
140 X 80	4,5	210	60	G212P140						3.226 €	3.527 €	3.527 €
140 X 80	12,5	218	60	G212P149								
120 X 90	4,5	210	49	G212P290				+ 98 €		2.894 €	3.195 €	3.195 €
120 X 90	11,5	217	49	G212P299								
140 X 90	4,5	210	60	G212P490						3.371 €	3.672 €	3.672 €
140 X 90	12,5	218	60	G212P499								
STANDARD + TECHO / TECTO												
					D	S	MF-	TF-	1	UU	HH	BB
120 X 80	4,5	217	49	G212P120						3.167 €	3.495 €	3.495 €
120 X 80	11,5	224	49	G212P129								
140 X 80	4,5	217	60	G212P140						3.635 €	3.977 €	3.977 €
140 X 80	12,5	225	60	G212P149								
120 X 90	4,5	217	49	G212P290				+ 98 €		3.304 €	3.645 €	3.645 €
120 X 90	11,5	224	49	G212P299								
140 X 90	4,5	217	60	G212P490						3.781 €	4.122 €	4.122 €
140 X 90	12,5	225	60	G212P499								
STANDARD +TECHO+LUZ / +TECTO+LUZ												
					D	S	MFL-	TFL-	1	UU	HH	BB
120 X 80	4,5	217	49	G212P120						3.576 €	3.945 €	3.945 €
120 X 80	11,5	224	49	G212P129								
140 X 80	4,5	217	60	G212P140						4.044 €	4.426 €	4.426 €
140 X 80	12,5	225	60	G212P149								
120 X 90	4,5	217	49	G212P290				+ 98 €		3.713 €	4.095 €	4.095 €
120 X 90	11,5	224	49	G212P299								
140 X 90	4,5	217	60	G212P490						4.190 €	4.572 €	4.572 €
140 X 90	12,5	225	60	G212P499								
HAMMAM												
					D	S	M5-	T5-	1	UU	HH	BB
120 X 80	4,5	217	49	G212P120						4.122 €	4.545 €	4.545 €
120 X 80	11,5	224	49	G212P129								
140 X 80	4,5	217	60	G212P140						4.590 €	5.028 €	5.028 €
140 X 80	12,5	225	60	G212P149								
120 X 90	4,5	217	49	G212P290				+ 98 €		4.259 €	4.696 €	4.696 €
120 X 90	11,5	224	49	G212P299								
140 X 90	4,5	217	60	G212P490						4.736 €	5.173 €	5.173 €
140 X 90	12,5	225	60	G212P499								



GLAX 1

GLAX 1 2P WHITE

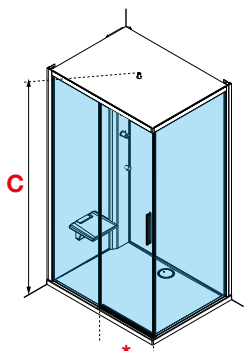

S Izquierda
Esquerda

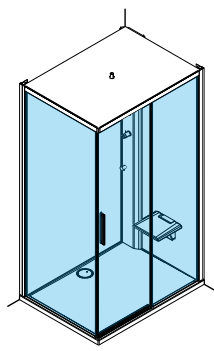

D Derecha
Direita

CABINA MULTIFUNCIÓN: MAMPARA EN ÁNGULO FORMADA POR DOS FIJOS Y DOS PUERTAS CORREDERAS DE ENTRADA POR EL VÉRTICE
CABINE DUCHA - RESGUARDO COMPUESTO POR DOIS FIXOS E DUAS PORTAS DE CORRER ABERTURA VÉRTICE

Design Marco Pellici

Medidas				Código	instalación		Mezclador Misturadora		cristal vidrio	Selección de color Seleccion de cores de acabados		
Medidas (cm.)	plato de ducha bases de chuveiro	altura cabina altura da cabine(cm)	Entrada		D	S	M	T		1	UU	HH
		C	*		Derecha Dereita	Izquierda Esquerda	Monomando Monocomando	Termostático Termostática	Transparente	White	Black	Silver Abrillatado
STANDARD												
					D	S	M-	T-	1	UU	HH	BB
80 X 80	4,5	210	40	G21A80	-	-				2.485 €	2.744 €	2.744 €
80 X 80	11,5	217	40	G21A89	-	-						
90 X 90	4,5	210	47	G21A90	-	-				2.554 €	2.819 €	2.819 €
90 X 90	11,5	217	47	G21A99	-	-						
100 X 100	4,5	210	54	G21A100	-	-				2.621 €	2.894 €	2.894 €
100 X 100	11,5	217	54	G21A109	-	-						
90 X 70	4,5	210	40	G21A9070				+ 98 €		2.485 €	2.744 €	2.744 €
90 X 70	11,5	217	40	G21A9079								
100 X 70	4,5	210	43,5	G21A107						2.554 €	2.819 €	2.819 €
100 X 70	11,5	217	43,5	G21A197								
100 X 80	4,5	210	47,5	G21A108						2.621 €	2.894 €	2.894 €
100 X 80	11,5	217	47,5	G21A198								
STANDARD + TECHO / TECTO												
					D	S	MF-	TF-	1	UU	HH	BB
80 X 80	4,5	217	40	G21A80	-	-				2.894 €	3.195 €	3.195 €
80 X 80	11,5	224	40	G21A89	-	-						
90 X 90	4,5	217	47	G21A90	-	-				2.963 €	3.269 €	3.269 €
90 X 90	11,5	224	47	G21A99	-	-						
100 X 100	4,5	217	54	G21A100	-	-				3.031 €	3.344 €	3.344 €
100 X 100	11,5	224	54	G21A109	-	-						
90 X 70	4,5	217	40	G21A9070				+ 98 €		2.894 €	3.195 €	3.195 €
90 X 70	11,5	224	40	G21A9079								
100 X 70	4,5	217	43,5	G21A107						2.963 €	3.269 €	3.269 €
100 X 70	11,5	224	43,5	G21A197								
100 X 80	4,5	217	47,5	G21A108						3.031 €	3.344 €	3.344 €
100 X 80	11,5	224	47,5	G21A198								
STANDARD + TECHO+LUZ / +TECTO+LUZ												
					D	S	MFL-	TFL-	1	UU	HH	BB
80 X 80	4,5	217	40	G21A80	-	-				3.304 €	3.645 €	3.645 €
80 X 80	11,5	224	40	G21A89	-	-						
90 X 90	4,5	217	47	G21A90	-	-				3.373 €	3.720 €	3.720 €
90 X 90	11,5	224	47	G21A99	-	-						
100 X 100	4,5	217	54	G21A100	-	-				3.440 €	3.795 €	3.795 €
100 X 100	11,5	224	54	G21A109	-	-						
90 X 70	4,5	217	40	G21A9070				+ 98 €		3.304 €	3.645 €	3.645 €
90 X 70	11,5	224	40	G21A9079								
100 X 70	4,5	217	43,5	G21A107						3.373 €	3.720 €	3.720 €
100 X 70	11,5	224	43,5	G21A197								
100 X 80	4,5	217	47,5	G21A108						3.440 €	3.795 €	3.795 €
100 X 80	11,5	224	47,5	G21A198								
HAMMAM												
					D	S	M5-	T5-	1	UU	HH	BB
80 X 80	4,5	217	40	G21A80	-	-				3.850 €	4.245 €	4.245 €
80 X 80	11,5	224	40	G21A89	-	-						
90 X 90	4,5	217	47	G21A90	-	-				3.919 €	4.320 €	4.320 €
90 X 90	11,5	224	47	G21A99	-	-						
100 X 100	4,5	217	54	G21A100	-	-				3.986 €	4.396 €	4.396 €
100 X 100	11,5	224	54	G21A109	-	-						
90 X 70	4,5	217	40	G21A9070				+ 98 €		3.850 €	4.245 €	4.245 €
90 X 70	11,5	224	40	G21A9079								
100 X 70	4,5	217	43,5	G21A107						3.919 €	4.320 €	4.320 €
100 X 70	11,5	224	43,5	G21A197								
100 X 80	4,5	217	47,5	G21A108						3.986 €	4.396 €	4.396 €
100 X 80	11,5	224	47,5	G21A198								

Construcción del código:
 Construção do código:

Código + **Lado** + **Mezclador Misturadora** + **Cristal Vidrio** + **Color Cores** = Código completo del producto
 Código completo do produto



GLAX 1

GLAX 1 A SILVER

80x80 | 90x90 | 100x100

90x70 | 100x70 | 100x80

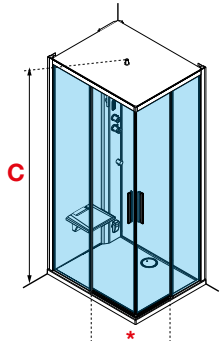
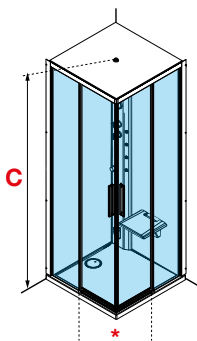

S Izquierda
Esquerda

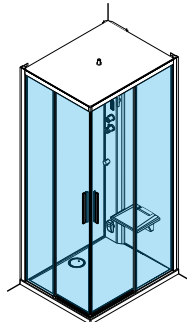

D Derecha
Direita

GLAX 1 G+F



CABINA MULTIFUNCIÓN: MAMPARA COMPUESTA POR UNA PUERTA ABATIBLE Y UN FIJO LATERAL
CABINE MULTIFUNCIÓN: RESGUARDO COMPOSTO POR UMA PORTA DOBRADA E UM LADO FIXO
 Design Marco Pellici

Medidas				Código	instalación		Mezclador Misturadora		cristal vidro	Selección de color Seleção de cores de acabados		
Medidas (cm.)	plato de ducha bases de chuveiro	altura cabina altura da cabine(cm)	Entrada		D	S	M	T		1	UU	HH
		C	*		Derecha Direita	Izquierda Esquerda	Monomando Monocomando	Termostático Termostática	Transparente	White	Black	Silver Abrilantado
STANDARD												
					D	S	M-	T-	1	UU	HH	BB
80 X 80	4,5	210	61	G21GF80						2.485 €	2.744 €	2.744 €
80 X 80	11,5	217	61	G21GF89				+ 98 €				
90 X 90	4,5	210	71	G21GF90						2.554 €	2.819 €	2.819 €
90 X 90	11,5	217	71	G21GF99								
STANDARD + TECTO / TECTO												
					D	S	MF-	TF-	1	UU	HH	BB
80 X 80	4,5	217	61	G21GF80						2.894 €	3.195 €	3.195 €
80 X 80	11,5	224	61	G21GF89				+ 98 €				
90 X 90	4,5	217	71	G21GF90						2.963 €	3.269 €	3.269 €
90 X 90	11,5	224	71	G21GF99								
STANDARD + TECTO + LUZ / + TECTO + LUZ												
					D	S	MFL-	TFL-	1	UU	HH	BB
80 X 80	4,5	217	61	G21GF80						3.304 €	3.645 €	3.645 €
80 X 80	11,5	224	61	G21GF89				+ 98 €				
90 X 90	4,5	217	71	G21GF90						3.373 €	3.720 €	3.720 €
90 X 90	11,5	224	71	G21GF99								
HAMMAM												
					D	S	M5-	T5-	1	UU	HH	BB
80 X 80	4,5	217	61	G21GF80						3.850 €	4.245 €	4.245 €
80 X 80	11,5	224	61	G21GF89				+ 98 €				
90 X 90	4,5	217	71	G21GF90						3.919 €	4.320 €	4.320 €
90 X 90	11,5	224	71	G21GF99								



GLAX 1

GLAX 1 G BLACK

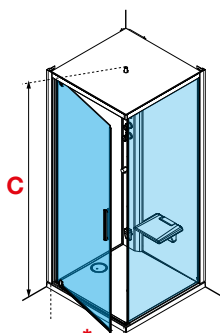

S Izquierda
Esquerda

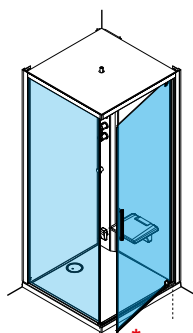

D Derecha
Direita

GLAX 1 R



CABINA MULTIFUNCIÓN: MAMPARA SEMICIRCULAR COMPUESTA POR DOS FIJOS Y DOS PUERTAS CORREDERAS CENTRALES

RESGUARDO PARA BASE SEMICIRCULAR COMPUESTO POR DUAS PORTAS DE CORRER E DOIS FIXOS

Design Marco Pellici

Medidas				Código	Mezclador Misturadora		cristal vidro	Selección de color Seleção de cores de acabados		
Medidas (cm.)	plato de ducha bases de chuveiro	altura cabina altura da cabine(cm)	Entrada		M	T		UU	HH	BB
		C	*		Monomando Monocomando	Termostático Termostática	Transparente	White	Black	Silver Abrillantado
STANDARD										
					M-	T-	1	UU	HH	BB
90 X 90	4,5	210	49	G21R90				3.031 €	3.344 €	3.344 €
90 X 90	11,5	217	49	G21R99		+ 98 €				
100 X 100	4,5	210	49	G21R100				3.167 €	3.495 €	3.495 €
100 X 100	11,5	217	49	G21R109						
STANDARD + TECTO / TECTO										
					MF-	TF-	1	UU	HH	BB
90 X 90	4,5	217	49	G21R90				3.440 €	3.795 €	3.795 €
90 X 90	11,5	224	49	G21R99		+ 98 €				
100 X 100	4,5	217	49	G21R100				3.576 €	3.945 €	3.945 €
100 X 100	11,5	224	49	G21R109						
STANDARD + TECTO+LUZ / +TECTO+LUZ										
					MFL-	TFL-	1	UU	HH	BB
90 X 90	4,5	217	49	G21R90				3.850 €	4.245 €	4.245 €
90 X 90	11,5	224	49	G21R99		+ 98 €				
100 X 100	4,5	217	49	G21R100				3.986 €	4.396 €	4.396 €
100 X 100	11,5	224	49	G21R109						
HAMMAM										
					M5-	T5-	1	UU	HH	BB
90 X 90	4,5	217	49	G21R90				4.396 €	4.846 €	4.846 €
90 X 90	11,5	224	49	G21R99		+ 98 €				
100 X 100	4,5	217	49	G21R100				4.532 €	4.996 €	4.996 €
100 X 100	11,5	224	49	G21R109						





GLAX 1

GLAX 1 R BLACK

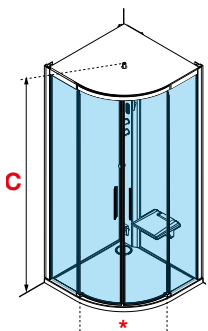

GLAX 1 A+F



CABINA MULTIFUNCIÓN A PARED, COMPUESTA POR UN PANEL FIJO LATERAL Y UNA MAMPARA ANGULAR DE ENTRADA EN EL VÉRTICE
CABINE MULTIFUNÇÃO À PAREDE, FORMADA POR UM PAINEL FIXO LATERAL E UM RESGUARDO DE CORRER DE CANTO
 Design Marco Pellici



OPCIONAL



Asiento en material acrílico opaco
Assento em material acrílico opaco

Código	Precio / Preço
SED030PL	391 €

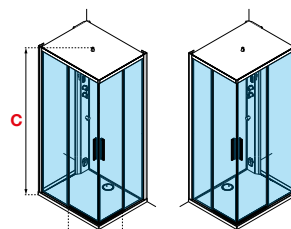

S Izquierda / Esquerda **D** Derecha / Direita

Medidas				Código	instalación		Mezclador / Misturadora		cristal / vidro	Selección de color / Selecção de cores de acabados		
Medidas (cm.)	plato de ducha / bases de chuveiro	altura cabina / altura da cabine (cm)	Entrada		D	S	M	T		UU	HH	BB
		C	*		Derecha / Direita	Izquierda / Esquerda	Monomando / Monocomando	Termostático / Termostática	Transparente	White	Black	Silver / Abrrilantado

STANDARD

Medidas (cm.)	plato de ducha / bases de chuveiro	altura cabina / altura da cabine (cm)	Entrada	Código	D	S	M-	T-	1	UU	HH	BB
100 X 80	4,5	210	47,5	G21AF108								
100 X 80	11,5	217	47,5	G21AF198				+ 98 €		2.753 €	3.040 €	3.040 €

STANDARD + TECHO / TECTO

Medidas (cm.)	plato de ducha / bases de chuveiro	altura cabina / altura da cabine (cm)	Entrada	Código	D	S	MF-	TF-	1	UU	HH	BB
100 X 80	4,5	217	47,5	G21AF108								
100 X 80	11,5	224	47,5	G21AF198				+ 98 €		3.183 €	3.513 €	3.513 €

STANDARD +TECHO+LUZ / +TECTO+LUZ

Medidas (cm.)	plato de ducha / bases de chuveiro	altura cabina / altura da cabine (cm)	Entrada	Código	D	S	MFL-	TFL-	1	UU	HH	BB
100 X 80	4,5	217	47,5	G21AF108								
100 X 80	11,5	224	47,5	G21AF198				+ 98 €		3.612 €	3.986 €	3.986 €

HAMMAM

Medidas (cm.)	plato de ducha / bases de chuveiro	altura cabina / altura da cabine (cm)	Entrada	Código	D	S	M5-	T5-	1	UU	HH	BB
100 X 80	4,5	217	47,5	G21AF108								
100 X 80	11,5	224	47,5	G21AF198				+ 98 €		4.186 €	4.615 €	4.615 €

GLAX 1 2P+2F



CABINA MULTIFUNCIÓN COMPUESTA POR DOS FIJOS LATERALES Y UNA MAMPARA FRONTAL DE FIJO Y PUERTA CORREDERA
CABINE MULTIFUNÇÃO À PAREDE, FORMADA POR DOIS PAINÉIS FIXOS LATERAIS E UM RESGUARDO FRONTAL DE PORTA DE CORRER

Design Marco Pellici



OPCIONAL



Asiento en material acrílico opaco
Assento em material acrílico opaco

Código	Precio / Preço
SED030PL	391 €

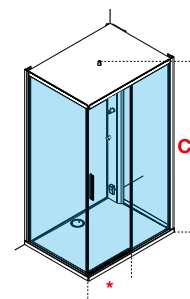

Medidas				Código	Mezclador Misturadora		cristal vidrio	Selección de color Seleccion de cores de acabados		
Medidas (cm.)	plato de ducha bases de chuveiro	altura cabina altura da cabine(cm)	Entrada		M	T		UU	HH	BB
		C	*		Monomando Monocomando	Termostático Termostática	Transparente	White	Black	Silver Abrrillantado
STANDARD										
					M-	T-	1	UU	HH	BB
120 X 80	4,5	210	49	G212PF120				2.897 €	3.196 €	3.196 €
120 X 80	11,5	217	49	G212PF129		+ 98 €				
STANDARD + TECHO / TECTO										
					MF-	TF-	1	UU	HH	BB
120 X 80	4,5	217	49	G212PF120				3.326 €	3.670 €	3.670 €
120 X 80	11,5	224	49	G212PF129		+ 98 €				
STANDARD +TECHO+LUZ / +TECTO+LUZ										
					MFL-	TFL-	1	UU	HH	BB
120 X 80	4,5	217	49	G212PF120				3.756 €	4.142 €	4.142 €
120 X 80	11,5	224	49	G212PF129		+ 98 €				
HAMMAM										
					M5-	T5-	1	UU	HH	BB
120 X 80	4,5	217	49	G212PF120				4.329 €	4.773 €	4.773 €
120 X 80	11,5	224	49	G212PF129		+ 98 €				

Construcción del código: **Código** + **Lado** + **Mezclador Misturadora** + **Cristal Vidrio** + **Color Cores** = Código completo del producto
 Construção do código: **Código** + **Lado** + **Mezclador Misturadora** + **Cristal Vidrio** + **Color Cores** = Código completo do produto



EON 2P HAMMAM BLANCO/ BRANCO



EON A HAMMAM SILVER/ ABRILLANTADO



EON G HAMMAM CROMO

EON | ACABADOS / ACABAMENTOS

ACABADO ESTRUCTURA



Blanco/ Branco
cod A



Silver/Abillantado
cod B



Cromo
cod K

CRISTAL / VIDRO



Transparente 6 mm

ACABADOS PANELES



Blanco brillo/ Branco brilhante
cod A

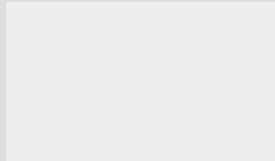

Blanco mate/ Branco mate
cod U

EON | EQUIPAMIENTO Y FUNCIONES (disponibles según versión)



- 

 Grifería monomando o termostática /
 Torneira monocomando ou termostática
 Ducha de mano con flexo /
 Chuveiro de mão com tubo flexível
- 

 Techo/ Teto
 Ducha fija tipo lluvia/ Duche fixo tipo chuva
- 
 Hidromasaje vertical y dorsal
 Hidromassagem vertical e dorsal
- 
 Repisa porta objetos
 Prateleira porta-objetos
- 
 Bluetooth
- 
 Mando a distancia "Touch Screen"
 Comando á distancia "Touch Screen"
- 

 Cromolight (hammam)
 Iluminacion interna LED (essential)
 Iluminação interna LED (essential)
- 
 Sauna de Vapor + Jet de vapor con porta-
 esencia
 Sauna de vapor + Jet de vapor com porta-
 essência



EON 2P HAMMAM CROMO



Mezclador monomando o termostático
Misturadora monocomando o termostática



Repisa integrada
Prateleira integrada



Sistema de hidromasaje vertical con pulverización.
Sistema de hidromassagem vertical pulverizado.



Mando a distancia (solo en la versión Hammam).
Telecomando (apenas na versão de Hammam).

EON



EON



CABINA MULTIFUNCIÓN - MAMPARA COMPUESTA POR UN FRONTAL DE FIJO Y PUERTA CORREDERA MÁS UN FIJO LATERAL
CABINE MULTIFUNÇÃO - RESGUARDO COMPUESTO POR UM FIXO E UMA PORTA DE CORRER E PAINEL FIXO LATERAL

Medidas				Código	instalación		Mezclador Misturadora		Hidro- masaje Hidromas- sagem	cristal vidro	Selección de color Seleção de cores de acabados					
Medidas (cm.)	plato de ducha bases de chuveiro	altura cabina altura da cabine(cm)	Entrada		D	S	M	T			1	Panel Blanco brillo Painel Branco brilhante			Panel Blanco mate Painel Branco mate	
											AA	AB	AK	UA	UB	UK
											Blanco Branco	Silver Abrillantado	Cromo	Blanco Branco	Silver Abrillantado	Cromo
STANDARD SIN TECHO STANDARD SEM TECTO																
					D	S	M-	T-		1	AA	AB	AK	UA	UB	UK
120x80	4,5	209,5	47	EON2P120					-		2.461 €	2.461 €	2.574 €	2.788 €	2.788 €	2.901 €
120x80	11,5	216,5	47	EON2P129					-							
120x90	4,5	209,5	47	EON2P290					+ 88 €							
120x90	11,5	216,5	47	EON2P299					-		2.563 €	2.563 €	2.675 €	2.891 €	2.891 €	3.003 €
STANDARD CON TECHO (PLAFÓN LUMINOSO CON INTERRUPTOR) STANDARD COM TECTO																
					D	S	M	T	T-	1	AA	AB	AK	UA	UB	UK
120x80	4,5	214	47	EON2P120							2.955 €	2.955 €	3.068 €	3.284 €	3.284 €	3.395 €
120x80	11,5	221	47	EON2P129												
120x90	4,5	214	47	EON2P290					+ 88 €							
120x90	11,5	221	47	EON2P299							3.057 €	3.057 €	3.169 €	3.385 €	3.385 €	3.497 €
HIDRO SIN TECHO SEM TECTO																
					D	S	M	T	1-	1	AA	AB	AK	UA	UB	UK
120x80	4,5	209,5	47	EON2P120							2.781 €	2.781 €	2.894 €	3.109 €	3.109 €	3.221 €
120x80	11,5	216,5	47	EON2P129												
120x90	4,5	209,5	47	EON2P290					+ 88 €							
120x90	11,5	216,5	47	EON2P299							2.883 €	2.883 €	2.997 €	3.211 €	3.211 €	3.325 €
HIDRO CON TECHO + DUCHA FIJO (TECHO LUMINOSO CON INTERRUPTOR) HIDRO COM TECTO + DUCHE FIXO (TECTO LUMINOSO COM INTERRUPTOR)																
					D	S	M	T	1F-	1	AA	AB	AK	UA	UB	UK
120x80	4,5	214	47	EON2P120							3.334 €	3.334 €	3.447 €	3.661 €	3.661 €	3.774 €
120x80	11,5	221	47	EON2P129												
120x90	4,5	214	47	EON2P290					+ 88 €							
120x90	11,5	221	47	EON2P299							3.437 €	3.437 €	3.548 €	3.763 €	3.763 €	3.876 €
HAMMAM (CROMOLIGHT CON MANDO A DISTANCIA) HAMMAM (CROMOLIGHT COM COMANDO À DISTANCIA)																
					D	S	M	T	1N-	1	AA	AB	AK	UA	UB	UK
120x80	4,5	229,5	47	EON2P120							4.164 €	4.164 €	4.275 €	4.491 €	4.491 €	4.604 €
120x80	11,5	236,5	47	EON2P129												
120x90	4,5	229,5	47	EON2P290					+ 88 €							
120x90	11,5	236,5	47	EON2P299							4.264 €	4.264 €	4.378 €	4.592 €	4.592 €	4.705 €



EON 2P HAMMAM CROMO

EON

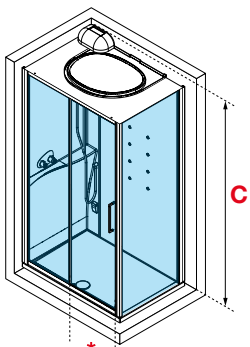

S Izquierda
Esquerda

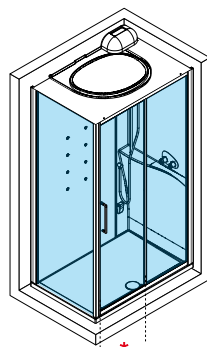

D Derecha
Direita

OPCIONAL



ASIENTO EN MATERIAL ACRÍLICO
OPACO DE ALTA RESISTENCIA
ASSENTO EM MATERIAL ACRILICO
OPACO DE ALTA RESISTENCIA

Código	Precio / Preço
SED030PL	391 €

EON 2P INSTALACIÓN ENTRE PAREDES



CABINA MULTIFUNCIÓN - MAMPARA COMPUESTA POR UN FRONTAL DE FIJO Y PUERTA CORREDERA
CABINE MULTIFUNÇÃO - RESGUARDO COMPUESTO POR UM FIXO E UMA PORTA DE CORRER

Medidas				Código	instalación		Mezclador Misturadora		Hidro-masaje Hidromasagem	cristal vidrio	Selección de color Seleção de cores de acabados					
Medidas (cm.)	plato de ducha bases de chuveiro	altura cabina altura da cabine (cm)	Entrada		D	S	M	T			Panel Blanco brillo Painel Branco brilhante			Panel Blanco mate Painel Branco mate		
									1	AA	AB	AK	UA	UB	UK	
										1	AA	AB	AK	UA	UB	UK
										Transparente	Blanco Branco	Silver Abrelantado	Cromo	Blanco Branco	Silver Abrelantado	Cromo
STANDAR SIN TECHA ENTRE PAREDES STANDARD SEM TECTO ENTRE PAREDES																
					D	S	M-	T-		1	AA	AB	AK	UA	UB	UK
120x80	4,5	209,5	48	EON2PN120							2.461 €	2.461 €	2.574 €	2.788 €	2.788 €	2.901 €
120x80	11,5	216,5	48	EON2PN129												
120x90	4,5	209,5	48	EON2PN290												
120x90	11,5	216,5	48	EON2PN299												
STANDARD CON TECHO ENTRE PAREDES (PLAFÓN LUMINOSO CON INTERRUPTOR) STANDARD COM TECTO ENTRE PAREDES																
					D	S	M	T	T-	1	AA	AB	AK	UA	UB	UK
120x80	4,5	214	48	EON2PN120							2.955 €	2.955 €	3.068 €	3.284 €	3.284 €	3.395 €
120x80	11,5	221	48	EON2PN129												
120x90	4,5	214	48	EON2PN290												
120x90	11,5	221	48	EON2PN299												
HIDRO SIN TECHO ENTRE PAREDES HIDRO SEM TECTO ENTRE PAREDES																
					D	S	M	T	1-	1	AA	AB	AK	UA	UB	UK
120x80	4,5	209,5	48	EON2PN120							2.781 €	2.781 €	2.894 €	3.109 €	3.109 €	3.221 €
120x80	11,5	216,5	48	EON2PN129												
120x90	4,5	209,5	48	EON2PN290												
120x90	11,5	216,5	48	EON2PN299												
HIDRO CON TECHO + DUCHA FIJO (TECHO LUMINOSO CON INTERRUPTOR) HIDRO COM TECTO + DUCHE FIXO (TECTO LUMINOSO COM INTERRUPTOR)																
					D	S	M	T	1F-	1	AA	AB	AK	UA	UB	UK
120x80	4,5	214	48	EON2PN120							3.334 €	3.334 €	3.447 €	3.661 €	3.661 €	3.774 €
120x80	11,5	221	48	EON2PN129												
120x90	4,5	214	48	EON2PN290												
120x90	11,5	221	48	EON2PN299												
HAMMAM INSTALACIÓN ENTRE PAREDES (CROMOLIGHT CON MANDO A DISTANCIA) HAMMAM INSTALAÇÃO ENTRE PAREDES (CROMOLIGHT COM COMANDO À DISTANCIA)																
					D	S	M	T	1N-	1	AA	AB	AK	UA	UB	UK
120x80	4,5	229,5	48	EON2PN120							4.164 €	4.164 €	4.275 €	4.491 €	4.491 €	4.604 €
120x80	11,5	236,5	48	EON2PN129												
120x90	4,5	229,5	48	EON2PN290												
120x90	11,5	236,5	48	EON2PN299												



EON 2P HAMMAM ENTRE PAREDES CROMO

EON

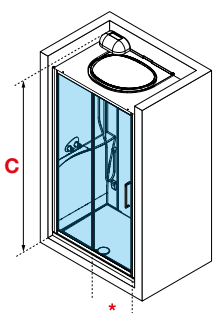

S Izquierda
Esquerda

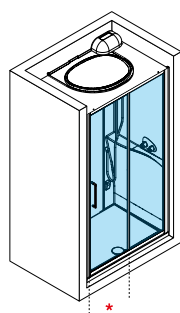

D Derecha
Direita

OPCIONAL



ASIENTO EN MATERIAL ACRÍLICO
OPACO DE ALTA RESISTENCIA
ASSENTO EM MATERIAL ACRILICO
OPACO DE ALTA RESISTENCIA

Código	Precio / Preço
SED030PL	391 €

CABINA MULTIFUNCIÓN: MAMPARA COMPUESTA POR DOS FIJOS Y DOS CORREDERAS DE APERTURA EN VÉRTICE
CABINE MULTIFUNÇÃO - RESGUARDO COMPUESTO POR DOIS FIXOS E DUAS PORTAS DE CORRER ABERTURA VÉRTICE

Medidas				Código	instalación		Mezclador Misturadora		Hidro-masaje Hidro-massagem	cristal vidrio	Selección de color Seleção de cores de acabados					
Medidas (cm.)	plato de ducha bases de chuveiro	altura cabina altura da cabine(cm)	Entrada		D	S	M	T			1	Panel Blanco brillo Painel Branco brilhante			Panel Blanco mate Painel Branco mate	
											AA	AB	AK	UA	UB	UK
											AA	AB	AK	UA	UB	UK
											AA	AB	AK	UA	UB	UK

STANDARD SIN TECHO
STANDARD SEM TECTO

					D	S	M-	T-		1	AA	AB	AK	UA	UB	UK
80x80	4,5	209,5	38	EONA80	-	-					2.113 €	2.113 €	2.225 €	2.440 €	2.440 €	2.554 €
80x80	11,5	216,5	38	EONA89	-	-										
90x90	4,5	209,5	45	EONA90	-	-					2.432 €	2.432 €	2.543 €	2.759 €	2.759 €	2.872 €
90x90	11,5	216,5	45	EONA99	-	-		+ 88 €								
100x80	4,5	209,5	45	EONA100							2.403 €	2.403 €	2.516 €	2.730 €	2.730 €	2.844 €
100x80	11,5	216,5	45	EONA109												

STANDARD CON TECHO (PLAFÓN LUMINOSO CON INTERRUPTOR)
STANDARD COM TECTO

					D	S	M	T	T-	1	AA	AB	AK	UA	UB	UK
80x80	4,5	214	38	EONA80	-	-					2.607 €	2.607 €	2.719 €	2.934 €	2.934 €	3.046 €
80x80	11,5	221	38	EONA89	-	-										
90x90	4,5	214	45	EONA90	-	-					2.928 €	2.928 €	3.040 €	3.254 €	3.254 €	3.369 €
90x90	11,5	221	45	EONA99	-	-		+ 88 €								
100x80	4,5	214	45	EONA100							2.897 €	2.897 €	3.010 €	3.225 €	3.225 €	3.338 €
100x80	11,5	221	45	EONA109												

HIDRO SIN TECHO
SEM TECTO

					D	S	M	T	1-	1	AA	AB	AK	UA	UB	UK
80x80	4,5	209,5	38	EONA80	-	-					2.432 €	2.432 €	2.543 €	2.759 €	2.759 €	2.872 €
80x80	11,5	216,5	38	EONA89	-	-										
90x90	4,5	209,5	45	EONA90	-	-					2.753 €	2.753 €	2.864 €	3.079 €	3.079 €	3.193 €
90x90	11,5	216,5	45	EONA99	-	-		+ 88 €								
100x80	4,5	209,5	45	EONA100							2.722 €	2.722 €	2.836 €	3.051 €	3.051 €	3.163 €
100x80	11,5	216,5	45	EONA109												

HIDRO CON TECHO + DUCHA FIJO (TECHO LUMINOSO CON INTERRUPTOR)
HIDRO COM TECTO + DUCHE FIXO (TECTO LUMINOSO COM INTERRUPTOR)

					D	S	M	T	1F-	1	AA	AB	AK	UA	UB	UK
80x80	4,5	214	38	EONA80	-	-					2.984 €	2.984 €	3.098 €	3.311 €	3.311 €	3.426 €
80x80	11,5	221	38	EONA89	-	-										
90x90	4,5	214	45	EONA90	-	-					3.304 €	3.304 €	3.417 €	3.631 €	3.631 €	3.745 €
90x90	11,5	221	45	EONA99	-	-		+ 88 €								
100x80	4,5	214	45	EONA100							3.275 €	3.275 €	3.389 €	3.604 €	3.604 €	3.715 €
100x80	11,5	221	45	EONA109												

HAMMAM (CROMOLIGHT CON MANDO A DISTANCIA)
HAMMAM (CROMOLIGHT COM COMANDO À DISTANCIA)

					D	S	M	T	1N-	1	AA	AB	AK	UA	UB	UK
80x80	4,5	229,5	38	EONA80	-	-					3.814 €	3.814 €	3.927 €	4.142 €	4.142 €	4.255 €
80x80	11,5	236,5	38	EONA89	-	-										
90x90	4,5	229,5	45	EONA90	-	-					4.133 €	4.133 €	4.247 €	4.462 €	4.462 €	4.574 €
90x90	11,5	236,5	45	EONA99	-	-		+ 88 €								
100x80	4,5	229,5	45	EONA100							4.105 €	4.105 €	4.218 €	4.433 €	4.433 €	4.545 €
100x80	11,5	236,5	45	EONA109												



EON A HAMMAM CROMO

EON

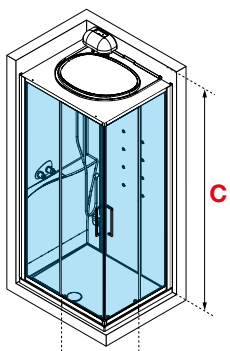

S Izquierda
Esquerda

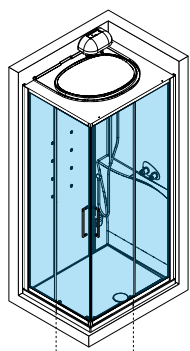

D Derecha
Direita

OPCIONAL



ASIENTO EN MATERIAL ACRÍLICO
OPACO DE ALTA RESISTENCIA
ASSENTO EM MATERIAL ACRÍLICO
OPACO DE ALTA RESISTENCIA

Código	Precio / Preço
SED030PL	391 €

CABINA MULTIFUNCIÓN: MAMPARA COMPUESTA POR UNA PUERTA ABATIBLE Y UN FIJO LATERAL
CABINE MULTIFUNCIÓN: MOMPARA COMPOSTA POR UMA PORTA DOBRADA E UM LADO FIXO

Medidas				Código	Mezclador Misturadora		Hidromasaje Hidromassa- gem	cristal vidro	Selección de color Seleção de cores de acabados					
Medidas (cm.)	plato de ducha bases de chuveiro	altura cabina altura da cabine(cm)	Entrada		M	T			Panel Blanco brillo Painel Branco brilhante			Panel Blanco mate Painel Branco mate		
						AA	AB	AK	UA	UB	UK			
			C		Monomando Monocomando	Termostático Termostática		1	Blanco Branco	Silver Abrillantado	Cromo	Blanco Branco	Silver Abrillantado	Cromo
STANDARD SIN TECHO STANDARD SEM TECTO														
					M-	T-		1	AA	AB	AK	UA	UB	UK
90x90	4,5	209,5	68	EONGF90		+ 88 €			2.432 €	2.432 €	2.543 €	2.759 €	2.759 €	2.872 €
90x90	11,5	216,5	68	EONGF99										
STANDARD CON TECHO (PLAFÓN LUMINOSO CON INTERRUPTOR) STANDARD COM TECTO														
					M	T	T-	1	AA	AB	AK	UA	UB	UK
90x90	4,5	214	68	EONGF90		+ 88 €			2.928 €	2.928 €	3.040 €	3.254 €	3.254 €	3.369 €
90x90	11,5	221	68	EONGF99										
HIDRO SIN TECHO SEM TECTO														
					M	T	1-	1	AA	AB	AK	UA	UB	UK
90x90	4,5	209,5	68	EONGF90		+ 88 €			2.753 €	2.753 €	2.864 €	3.079 €	3.079 €	3.193 €
90x90	11,5	216,5	68	EONGF99										
HIDRO CON TECHO + DUCHA FIJO (TECHO LUMINOSO CON INTERRUPTOR) HIDRO COM TECTO + DUCHE FIXO (TECTO LUMINOSO CON INTERRUPTOR)														
					M	T	1F-	1	AA	AB	AK	UA	UB	UK
90x90	4,5	214	68	EONGF90		+ 88 €			3.304 €	3.304 €	3.417 €	3.631 €	3.631 €	3.745 €
90x90	11,5	221	68	EONGF99										
HAMMAM (CROMOLIGHT CON MANDO A DISTANCIA) HAMMAM (CROMOLIGHT COM COMANDO À DISTANCIA)														
					M	T	1N-	1	AA	AB	AK	UA	UB	UK
90x90	4,5	229,5	68	EONGF90		+ 88 €			4.133 €	4.133 €	4.247 €	4.462 €	4.462 €	4.574 €
90x90	11,5	236,5	68	EONGF99										

LAS PAREDES DE LA CABINA SE PUEDEN INVERTIR PARA CAMBIAR A DERECHA O IZQUIERDA
PAREDES DA CABINE PODEM SER INVERTIDAS PARA MUDAR A DIREITA OU ESQUERDA



EON GF HAMMAM CROMO

EON

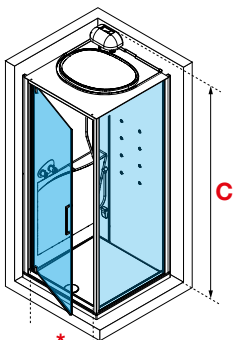

S Izquierda
Esquerda

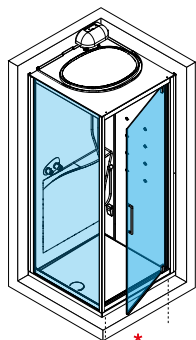

D Derecha
Direita

OPCIONAL



ASIENTO EN MATERIAL ACRÍLICO
OPACO DE ALTA RESISTENCIA
ASSENTO EM MATERIAL ACRILICO
OPACO DE ALTA RESISTENCIA

Código	Precio / Preço
SED030PL	391 €

EON G INSTALACIÓN ENTRE PAREDES



CABINA MULTIFUNCIÓN - MAMPARA COMPUESTA POR UNA PUERTA ABATIBLE
CABINE MULTIFUNÇÃO - RESGUARDO COMPUESTO POR UMA PORTA ABATÍVEL

Medidas				Código	Mezclador Misturadora		Hidromasaje Hidromassagem	cristal vidro	Selección de color Seleção de cores de acabados					
Medidas (cm.)	plato de ducha bases de chuveiro	altura cabina altura da cabine(cm)	Entrada		M	T			1	Panel Blanco brillo Painel Branco brilhante			Panel Blanco mate Painel Branco mate	
									AA	AB	AK	UA	UB	UK
									Blanco Branco	Silver Abrillantado	Cromo	Blanco Branco	Silver Abrillantado	Cromo
C														
STANDAR SIN TECHA ENTRE PAREDES STANDARD SEM TECTO ENTRE PAREDES														
					M-	T-		1	AA	AB	AK	UA	UB	UK
80x80	4,5	209,5	56	EONGN80					2.113 €	2.113 €	2.225 €	2.440 €	2.440 €	2.554 €
80x80	11,5	216,5	56	EONGN89										
90x90	4,5	209,5	66	EONGN90		+ 88 €			2.432 €	2.432 €	2.543 €	2.759 €	2.759 €	2.872 €
90x90	11,5	216,5	66	EONGN99										
STANDARD CON TECHO ENTRE PAREDES (PLAFÓN LUMINOSO CON INTERRUPTOR) STANDARD COM TECTO ENTRE PAREDES														
					M	T	T-	1	AA	AB	AK	UA	UB	UK
80x80	4,5	214	56	EONGN80					2.607 €	2.607 €	2.719 €	2.934 €	2.934 €	3.046 €
80x80	11,5	221	56	EONGN89										
90x90	4,5	214	66	EONGN90		+ 88 €			2.928 €	2.928 €	3.040 €	3.254 €	3.254 €	3.369 €
90x90	11,5	221	66	EONGN99										
HIDRO SIN TECHO ENTRE PAREDES HIDRO SEM TECTO ENTRE PAREDES														
					M	T	1-	1	AA	AB	AK	UA	UB	UK
80x80	4,5	209,5	56	EONGN80					2.432 €	2.432 €	2.543 €	2.759 €	2.759 €	2.872 €
80x80	11,5	216,5	56	EONGN89										
90x90	4,5	209,5	66	EONGN90		+ 88 €			2.753 €	2.753 €	2.864 €	3.079 €	3.079 €	3.193 €
90x90	11,5	216,5	66	EONGN99										
HIDRO CON TECHO + DUCHA FIJO (TECHO LUMINOSO CON INTERRUPTOR) HIDRO COM TECTO + DUCHE FIXO (TECTO LUMINOSO COM INTERRUPTOR)														
					M	T	1F-	1	AA	AB	AK	UA	UB	UK
80x80	4,5	214	56	EONGN80					2.984 €	2.984 €	3.098 €	3.311 €	3.311 €	3.426 €
80x80	11,5	221	56	EONGN89										
90x90	4,5	214	66	EONGN90		+ 88 €			3.304 €	3.304 €	3.417 €	3.631 €	3.631 €	3.745 €
90x90	11,5	221	66	EONGN99										
HAMMAM INSTALACIÓN ENTRE PAREDES (CROMOLIGHT CON MANDO A DISTANCIA) HAMMAM INSTALAÇÃO ENTRE PAREDES (CROMOLIGHT COM COMANDO À DISTANCIA)														
					M	T	1N-	1	AA	AB	AK	UA	UB	UK
80x80	4,5	229,5	56	EONGN80					3.814 €	3.814 €	3.927 €	4.142 €	4.142 €	4.255 €
80x80	11,5	236,5	56	EONGN89										
90x90	4,5	229,5	66	EONGN90		+ 88 €			4.133 €	4.133 €	4.247 €	4.462 €	4.462 €	4.574 €
90x90	11,5	236,5	66	EONGN99										



EON

EON G ENTRE PAREDES HAMMAM CROMO

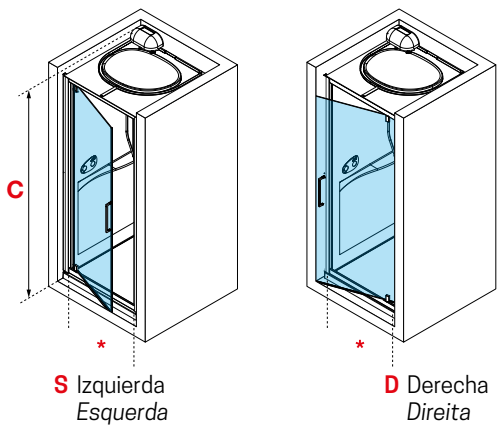

OPCIONAL



**ASIENTO EN MATERIAL ACRÍLICO
OPACO DE ALTA RESISTENCIA
ASSENTO EM MATERIAL ACRILICO
OPACO DE ALTA RESISTENCIA**

Código	Precio / Preço
SED030PL	391 €



CABINA MULTIFUNCIÓN: MAMPARA SEMICIRCULAR COMPUESTA POR DOS FIJOS Y DOS PUERTAS CORREDERAS CENTRALES
CABINE MULTIFUNÇÃO - RESGUARDO PARA BASE SEMICIRCULAR COMPUESTO POR DUAS PORTAS DE CORRER E DOIS FIXOS

Medidas				Código	Mezclador Misturadora		Hidromasaje Hidromassagem	cristal vidro	Selección de color Seleção de cores de acabados					
Medidas (cm.)	plato de ducha bases de chuveiro	altura cabina altura da cabine(cm)	Entrada		M	T			Panel Blanco brillo Painel Branco brilhante			Panel Blanco mate Painel Branco mate		
								1	AA	AB	AK	UA	UB	UK
									Blanco Branco	Silver Abrillantado	Cromo	Blanco Branco	Silver Abrillantado	Cromo
				C										
				*										
					Monomando Monocomando	Termostático Termostática		Transpa- rente						
STANDARD SIN TECTO STANDARD SEM TECTO														
					M-	T-		1	AA	AB	AK	UA	UB	UK
90x90	4,5	209,5	48	EONR90		+ 88 €			2.650 €	2.650 €	2.763 €	2.978 €	2.978 €	3.090 €
90x90	11,5	216,5	48	EONR99										
STANDARD CON TECTO (PLAFÓN LUMINOSO CON INTERRUPTOR) STANDARD COM TECTO														
					M	T	T-	1	AA	AB	AK	UA	UB	UK
90x90	4,5	214	48	EONR90		+ 88 €			3.145 €	3.145 €	3.257 €	3.472 €	3.472 €	3.585 €
90x90	11,5	221	48	EONR99										
HIDRO SIN TECTO SEM TECTO														
					M	T	1-	1	AA	AB	AK	UA	UB	UK
90x90	4,5	209,5	48	EONR90		+ 88 €			2.970 €	2.970 €	3.082 €	3.297 €	3.297 €	3.410 €
90x90	11,5	216,5	48	EONR99										
HIDRO CON TECTO + DUCHA FIJO (TECHO LUMINOSO CON INTERRUPTOR) HIDRO COM TECTO + DUCHE FIXO (TECTO LUMINOSO COM INTERRUPTOR)														
					M	T	1F-	1	AA	AB	AK	UA	UB	UK
90x90	4,5	214	48	EONR90		+ 88 €			3.523 €	3.523 €	3.636 €	3.851 €	3.851 €	3.964 €
90x90	11,5	221	48	EONR99										
HAMMAM (CROMOLIGHT CON MANDO A DISTANCIA) HAMMAM (CROMOLIGHT COM COMANDO À DISTANCIA)														
					M	T	1N-	1	AA	AB	AK	UA	UB	UK
90x90	4,5	229,5	48	EONR90		+ 88 €			4.351 €	4.351 €	4.466 €	4.679 €	4.679 €	4.793 €
90x90	11,5	236,5	48	EONR99										



EON R HAMMAM CROMO

EON

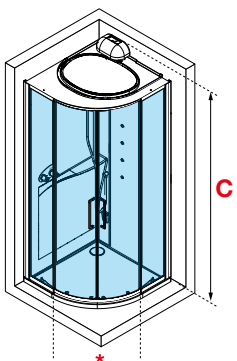

OPCIONAL



**ASIENTO EN MATERIAL ACRÍLICO
OPACO DE ALTA RESISTENCIA
ASSENTO EM MATERIAL ACRILICO
OPACO DE ALTA RESISTENCIA**

Código	Precio / Preço
SED030PL	391 €



MEDIA GLASS 2P



MEDIA GLASS GF

MEDIA GLASS | ACABADOS / ACABAMENTOS

ACABADOS PERFILES / PERFIS



Blanco
Branco
cod A

CRISTAL/ VIDRO



Transparente
4 mm

MEDIA GLASS | EQUIPAMIENTO Y FUNCIONES (disponibles según versión)



Grifería monomando o termostática /
Torneira monocomando ou termostática
Ducha de mano con flexo/
Chuveiro de mão com tubo flexível

Techo/Teto
Ducha fija tipo lluvia/ Duche fixo tipo chuva

Repisas porta objetos
Prateleiras porta-objectos



MEDIA GLASS A

MEDIA GLASS



Fácil instalación directamente en la esquina
Instalação fácil directamente no canto



Paredes traseras
Vidrio templado de 4 mm
Paredes traseiras
Vidro temperado de 4 mm



Repisas porta objetos
Prateleiras porta-objetos



Guía deslizante con articulación frontal
Calha deslizante com junta frontal

MEDIA GLASS

MEDIA GLASS 2P



CABINA MULTIFUNCIÓN - MAMPARA COMPUESTA POR UN FRONTAL DE FIJO Y PUERTA CORREDERA MÁS UN FIJO LATERAL
CABINE MULTIFUNÇÃO - RESGUARDO COMPUESTO POR UM FIXO E UMA PORTA DE CORRER E PAINEL FIXO LATERAL

Medidas			Código	Mezclador Misturadora		Cristal Vidro	Selección de color Seleção de cores de acabados
Medidas (cm.)	altura cabina altura da cabine(cm)	Entrada		M	T	1	Acabado blanco brillo Acabado branco brilho
	C	*		Monomando Monocomando	Termostático Termostática	Transparente	Blanco Branco

STANDARD							
				M-	T-	1	AA
120 X 80	210	47	MEG2P120		+ 85 €		2.255 €

HIDRO CON TECHO + DUCHA FIJO HIDRO COM TECTO + DUCHE FIXO							
				MF-	TF-	1	AA
120 X 80	226	47	MEG2P120		+ 85 €		2.530 €



MEDIA GLASS

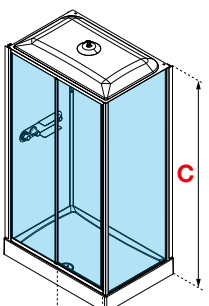

S Izquierda
Esquerda

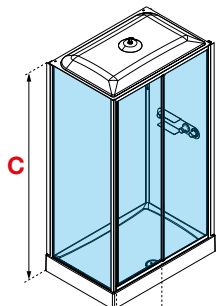

D Derecha
Direita

MEDIA GLASS GF



207 cm



3 mm
puerta/
porta



4 mm



CABINA MULTIFUNCIÓN: MAMPARA COMPUESTA POR UNA PUERTA ABATIBLE Y UN FIJO LATERAL
CABINE MULTIFUNCIONAL: MOMPARA COMPOSTA POR UMA PORTA DOBRADA E UM LADO FIXO

Medidas			Código	Mezclador Misturadora		Cristal Vidro	Selección de color Seleção de cores de acabados
Medidas (cm.)	altura cabina altura da cabine (cm)	Entrada		M	T	1	Acabado blanco brillo
	C	*		Monomando Monocomando	Termostático Termostática	Transparente	AA Blanco Branco

STANDARD



				M-	T-	1	AA
80 X 80	210	60	MEGGF80				1.714 €
90 X 90	210	70	MEGGF90		+ 85 €		2.049 €

HIDRO CON TECHO + DUCHA FIJO HIDRO COM TECTO + DUCHE FIXO



				MF-	TF-	1	AA
80 X 80	226	60	MEGGF80				1.990 €
90 X 90	226	70	MEGGF90		+ 85 €		2.325 €



MEDIA GLASS

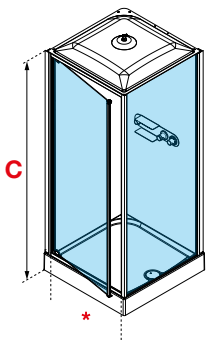

S Izquierda
Esquerda

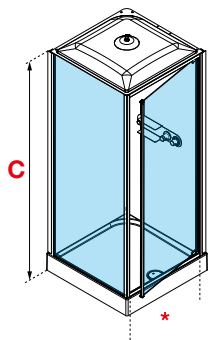

D Derecha
Direita

MEDIA GLASS A



CABINA MULTIFUNCIÓN: MAMPARA COMPUESTA POR DOS FIJOS Y DOS CORREDERAS DE APERTURA EN VÉRTICE
CABINE MULTIFUNÇÃO - RESGUARDO COMPUESTO POR DOIS FIXOS E DUAS PORTAS DE CORRER ABERTURA VÉRTICE



Medidas			Código	Mezclador Misturadora		Cristal Vidro	Selección de color Seleção de cores de acabados
Medidas (cm.)	altura cabina altura da cabine(cm)	Entrada		M	T		1
	C	*		Monomando Monocomando	Termostático Termostática	Transparente	Blanco Branco

80x80 - 90x90

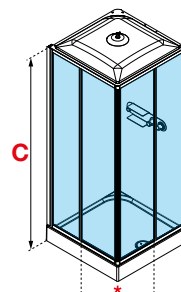

STANDARD							
			M-	T-	1	AA	
80 X 80	210	44	MEGA80			1.739 €	
90 X 90	210	48	MEGA90			1.945 €	
90 X 70	210	36	MEGA7090		+ 85 €		
100 X 70	210	48	MEGA107			2.048 €	
100 X 80	210	50	MEGA100				

90x70 - 100x70 - 100x80

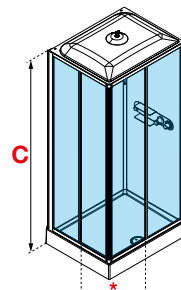

HIDRO CON TECHO + DUCHA FIJO HIDRO COM TECTO + DUCHE FIXO							
			MF-	TF-	1	AA	
80 X 80	226	44	MEGA80			2.015 €	
90 X 90	226	48	MEGA90			2.221 €	
90 X 70	226	36	MEGA7090		+ 85 €		
100 X 70	226	48	MEGA107			2.323 €	
100 X 80	226	50	MEGA100				

D Derecha
Direita

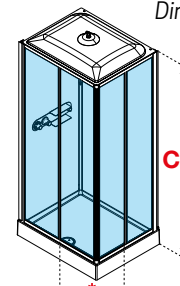

S Izquierda
Esquerda



MEDIA GLASS R



CABINA MULTIFUNCIÓN: MAMPARA SEMICIRCULAR COMPUESTA POR DOS FIJOS Y DOS PUERTAS CORREDERAS CENTRALES
CABINE MULTIFUNÇÃO - RESGUARDO PARA BASE SEMICIRCULAR COMPUESTO POR DUAS PORTAS DE CORRER E DOIS FIXOS



Medidas			Código	Mezcladora Misturadora		Cristal Vidro	Selección de color Seleção de cores de acabados	
Medidas (cm.)	altura cabina altura da cabine(cm)	Entrada		M	T		Acabado blanco brillo	
	C	*		Monomando Monocomando	Termostático Termostática	1	Transparente	AA Blanco Branco

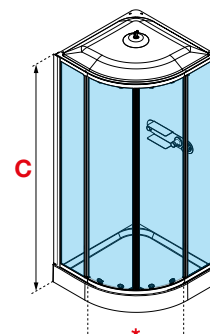

STANDARD							
				M-	T-	1	AA
90 X 90	210	48	MEGR90		+ 85 €		2.192 €

HIDRO CON TECHO + DUCHA FIJO HIDRO COM TECTO + DUCHE FIXO							
				MF-	TF-	1	AA
90 X 90	226	48	MEGR90		+ 85 €		2.468 €

Construcción del código: **Código** + **Mezclador Misturadora** + **Cristal Vidro** + **Color Cores** = Código completo del producto
 Construção do código: **Código** + **Mezclador Misturadora** + **Cristal Vidro** + **Color Cores** = Código completo do produto



MEDIA | ACABADOS / ACABAMENTOS

ACABADOS PERFILES / PERFIS



Blanco
Branco
cod A



Silver
Abrillantado
cod B

CRISTAL/ VIDRO



Transparente 3 mm

MEDIA | EQUIPAMIENTO Y FUNCIONES (disponibles según versión)



Grifería monomando o termostática /
Torneira monocomando ou termostática
Ducha de mano con flexo/
Chuveiro de mão com tubo flexível



Techo/Teto
Ducha fija tipo lluvia/ Duche fixo tipo chuva



Hidromasaje vertical
Hidromassagem vertical



2 Repisas porta objetos
2 Prateleiras porta-objects





Sistema de hidromasaje vertical
Sistema de hidromassagem vertical



Repisa portaobjetos
Estante portaobjetos



Techo con ducha fija integrada
Tecto com ducha fixo integrado



La cabina de hidromasaje más esencial y de formas más nítidas.
A cabine de hidromassagem mais essencial e de formas mais nítidas



MEDIA

MEDIA

MEDIA 2P



207 cm



3 mm



CABINA DE DUCHA - MAMPARA COMPUESTA POR UN FRONTAL DE FIJO Y PUERTA CORREDERA MÁS UN FIJO LATERAL
CABINE DUCHA RESGUARDO COMPOSTO POR UM FRONTAL DA FIXO E PORTA DA CORRER E PAINEL FIXO LATERAL



Medidas			Código	Mezclador Misturadora		cristal vidro	Selección de color Seleção de cores de acabados	
Medidas (cm.)	altura cabina altura da cabine(cm)	Entrada		M	T		1	AA
	C	*		Monomando Monocomando	Termostático Termostática	Transparente	Blanco Branco	Silver Abrillantado
STANDARD								
				M-	T-	1	AA	AB
120 X 80	210	47	ME22P120		+ 88 €		1.863 €	2.013 €
HIDRO SIN TECHO SEM TECTO								
				M	T	1-	AA	AB
120 X 80	210	47	ME22P120		+ 88 €		2.138 €	2.289 €
HIDRO CON TECHO Y DUCHA FIJA COM TECTO E DUCHE FIXO								
				M	T	1F-	AA	AB
120 X 80	226	47	ME22P120		+ 88 €		2.491 €	2.643 €

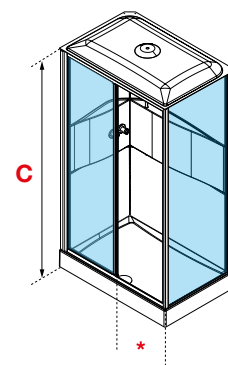

Izquierda
Esquerda

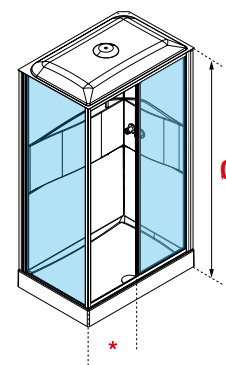

Derecha
Direita

MEDIA GF



207 cm



3 mm



CABINA MULTIFUNCIÓN: MAMPARA COMPUESTA POR UNA PUERTA ABATIBLE Y UN FIJO LATERAL
CABINE MULTIFUNCCIONAL: MOMPARA COMPOSTA POR UMA PORTA DOBRADA E UM LADO FIXO



Medidas			Código	Mezclador Misturadora		cristal vidro	Selección de color Seleção de cores de acabados	
Medidas (cm.)	altura cabina altura da cabine(cm)	Entrada		M	T		1	AA
	C	*		Monomando Monocomando	Termostático Termostática	Transparente	Blanco Branco	Silver Abrilantado
STANDARD								
				M-	T-		1	AA AB
80 X 80	210	60	ME2GF80		+ 88 €		1.397 €	1.511 €
90 X 90	210	70	ME2GF90				1.497 €	1.617 €
HIDRO SIN TECHO SEM TECTO								
				M	T	1-	1	AA AB
80 X 80	210	60	ME2GF80		+ 88 €		1.673 €	1.786 €
90 X 90	210	70	ME2GF90				1.770 €	1.891 €
HIDRO CON TECHO Y DUCHA FIJA COM TECTO E DUCHE FIXO								
				M	T	1F-	1	AA AB
80 X 80	226	60	ME2GF80		+ 88 €		2.027 €	2.138 €
90 X 90	226	70	ME2GF90				2.124 €	2.245 €

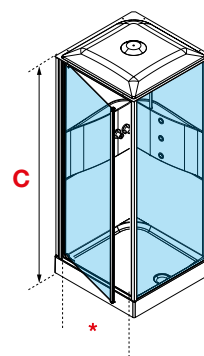

Izquierda
Esquerda

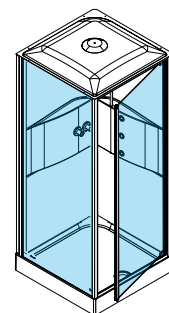

Derecha
Direita

MEDIA

Construcción del código: **Código** + **Mezclador Misturadora** + **Hidromasaje Hidromassagem** + **Cristal Vidro** + **Color Cores** = Código completo del producto
 Construção do código: **Código** + **Mezclador Misturadora** + **Hidromasaje Hidromassagem** + **Cristal Vidro** + **Color Cores** = Código completo do produto

CABINA MULTIFUNCIÓN: MAMPARA COMPUESTA POR DOS FIJOS Y DOS CORREDERAS DE APERTURA EN VÉRTICE
CABINE MULTIFUNÇÃO - RESGUARDO COMPUESTO POR DOIS FIXOS E DUAS PORTAS DE CORRER ABERTURA VÉRTICE

Medidas			Código	Mezclador Misturadora			cristal vidro	Selección de color Seleção de cores de acabados	
Medidas (cm.)	altura cabina altura da cabine(cm)	Entrada		M	T		1	AA	AB
	C	*		Monomando Monocomando	Termostático Termostática		Transparente	Blanco Branco	Silver Abrillantado
STANDARD									
				M-	T-		1	AA	AB
80 X 80	210	44	ME2A80					1.299 €	1.402 €
90 X 90	210	48	ME2A90					1.397 €	1.511 €
90 X 70	210	36	ME2A7090		+ 88 €				
100 X 70	210	48	ME2A107					1.582 €	1.709 €
100 X 80	210	50	ME2A100						
HIDRO SIN TECHO SEM TECTO									
				M	T	1-	1	AA	AB
80 X 80	210	44	ME2A80					1.573 €	1.678 €
90 X 90	210	48	ME2A90					1.673 €	1.786 €
90 X 70	210	36	ME2A7090		+ 88 €				
100 X 70	210	48	ME2A107					1.855 €	1.984 €
100 X 80	210	50	ME2A100						
HIDRO CON TECHO Y DUCHA FIJA COM TECTO E DUCHE FIXO									
				M	T	1F-	1	AA	AB
80 X 80	226	44	ME2A80					1.927 €	2.032 €
90 X 90	226	48	ME2A90					2.027 €	2.138 €
90 X 70	226	36	ME2A7090		+ 88 €				
100 X 70	226	48	ME2A107					2.209 €	2.336 €
100 X 80	226	50	ME2A100						



MEDIA

80x80 - 90x90

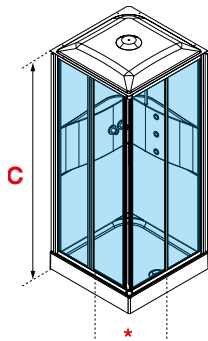

90x70 - 100x70 - 100x80

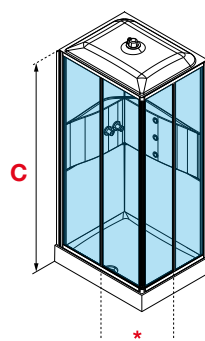

Izquierda
Esquerda

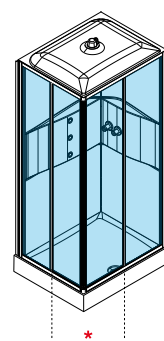

Derecha
Direita

MEDIA R



CABINA MULTIFUNCIÓN: MAMPARA SEMICIRCULAR COMPUESTA POR DOS FIJOS Y DOS PUERTAS CORREDERAS CENTRALES
CABINE MULTIFUNÇÃO - RESGUARDO PARA BASE SEMICIRCULAR COMPUESTO POR DUAS PORTAS DE CORRER E DOIS FIXOS

Medidas			Código	Mezclador Misturadora			cristal vidro	Selección de color Seleção de cores de acabados	
Medidas (cm.)	altura cabina altura da cabine(cm)	Entrada		M	T		1	AA	AB
	C	*		Monomando Mono- comando	Termostático Termostática		Transparente	Blanco Branco	Silver Abrillantado
STANDARD									
				M-	T-		1	AA	AB
90 X 90	210	48	ME2R90		+ 88 €			1.721 €	1.860 €
HIDRO SIN TECHO SEM TECTO									
				M	T	1-	1	AA	AB
90 X 90	210	48	ME2R90		+ 88 €			1.997 €	2.135 €
HIDRO CON TECHO Y DUCHA FIJA COM TECTO E DUCHE FIXO									
				M	T	1F-	1	AA	AB
90 X 90	226	48	ME2R90		+ 88 €			2.351 €	2.489 €



MEDIA

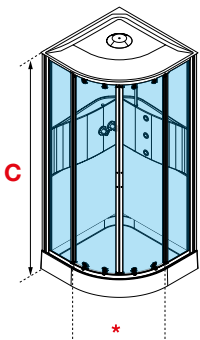

SKILL DUAL PLATO BORDE / BASE DE DUCHE REBORDO 45 MM DATOS TÉCNICOS / DADOS TÉCNICOS

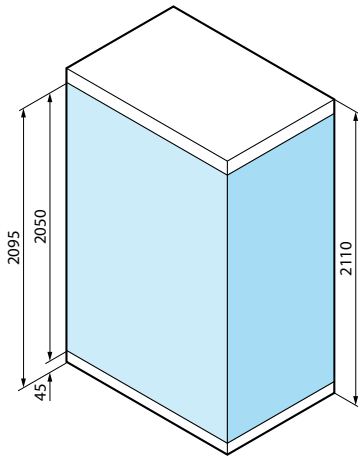

instalación a una sola pared / instalação centro de parede

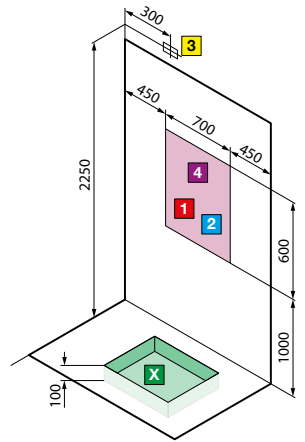

versión izquierda / versão esquerda

versión derecha / versão direita

instalación en ángulo / instalação angulada

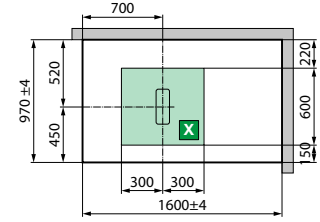
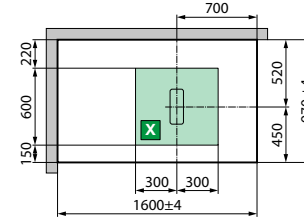
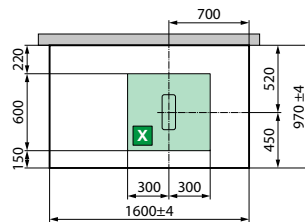
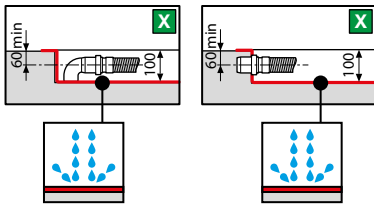
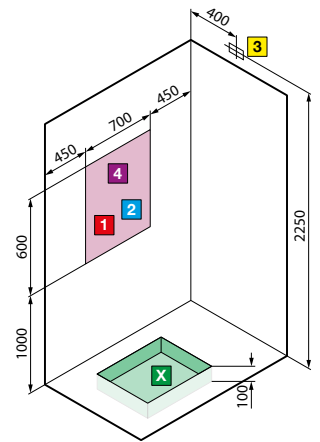
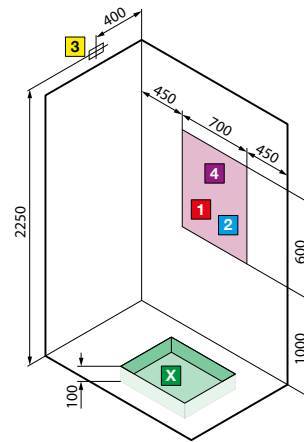

SKILL DUAL PLATO BORDE / BASE DE DUCHE REBORDO 125 MM

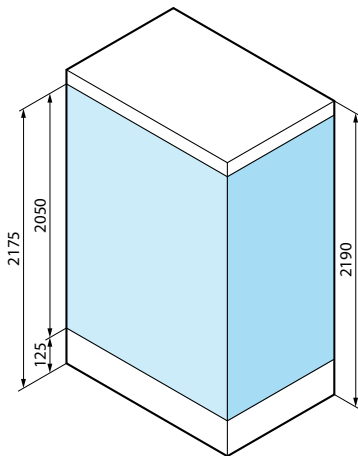

instalación a una sola pared / instalação centro de parede

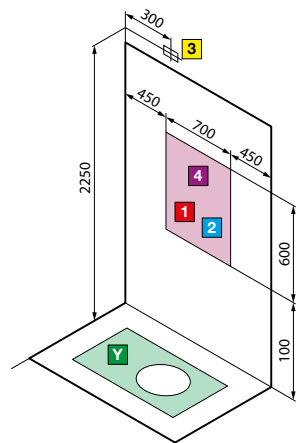

versión izquierda / versão esquerda

versión derecha / versão direita

instalación en ángulo / instalação angulada

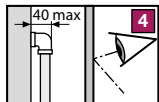
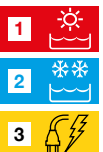
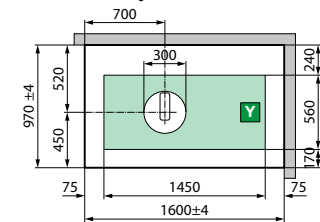
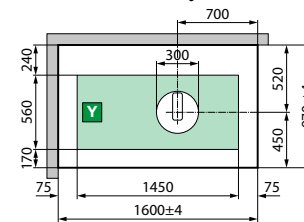
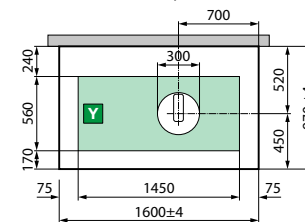
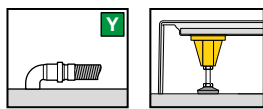
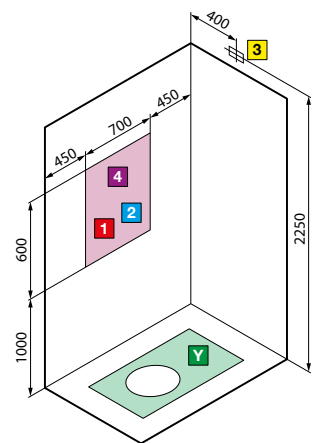
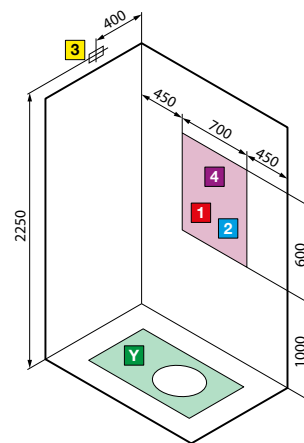

No inspeccionable / Não ispeccionável

 El producto está certificado de acuerdo con la normativa de compatibilidad electromagnética
EN55014-1
EN55014-2
 O produto é certificado de acordo com os regulamentos de compatibilidade eletromagnética

 **ATENCIÓN!!** Puede ser perjudicial para las personas que utilizan marcapasos
ATENÇÃO!! Pode ser prejudicial para pessoas que usem pacemaker

CARACTERÍSTICAS HIDRÁULICAS

- Presión requerida 2=5 bar
- Agua caliente 1/2" / Água quente 1/2"
- Agua fría 1/2" / Água fría 1/2"
- Conexión del sifón de Ø 40 mm / Ligaçao sifão de Ø 40 mm

CARACTERÍSTICAS ELÉCTRICAS

- Tensión: 220-230 V / Tensão: 220-230 V
- Frecuencia: 50/60 Hz / Frequência: 50/60 Hz
- Potencia máxima absorbida / Potencia maxima absorbida: 5100 W
- Potencia nominal: 5000 W

Debe instalarse un interruptor diferencial de 30 mA con una apertura mínima de los contactos igual a 3 mm. fabricado según la legislación vigente. Deve instalar-se um interruptor diferencial de 30mA com uma abertura mínima dos contactos igual a 3 mm. Fabricado segundo as normas.

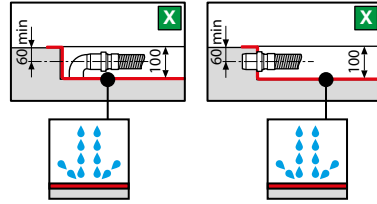
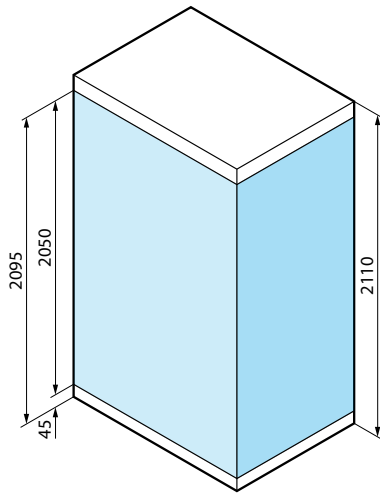

versión izquierda / versão esquerda | versión derecha / versão direita
 para modelos **A100x80 - A120x80 - A120x90 - A120x100 - 2P 140x80**

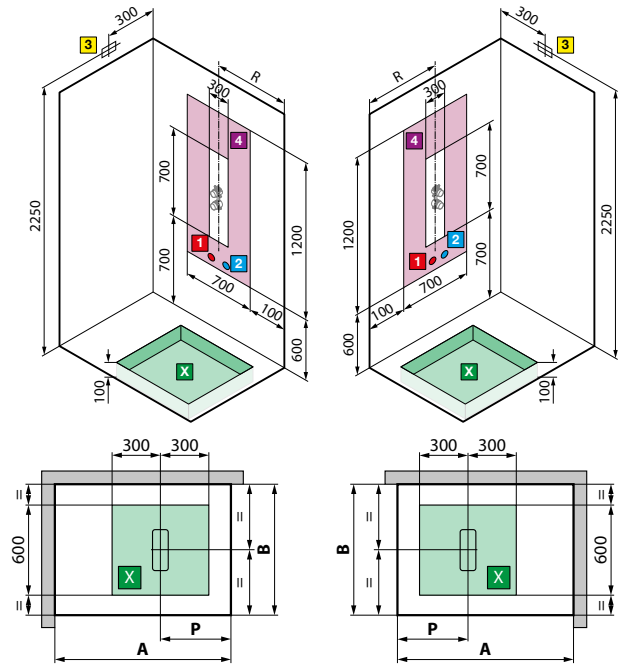

modelo	A ± 2	B ± 2	P	R
A100x80	1000	800	400	450
A120x80	1200	800	500	550
A120x90	1200	900	500	550
A120x100	1200	1000	500	550
2P140x80	1400	800	600	650

SKILL PLATO BORDE / BASE DE DUCHE REBORDO 125 MM

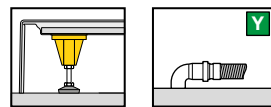
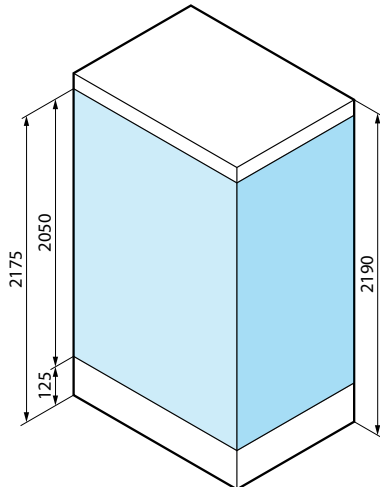

versión izquierda / versão esquerda | versión derecha / versão direita
 para modelos **A100x80 - A120x80 - A120x90 - A120x100 - 2P 140x80**

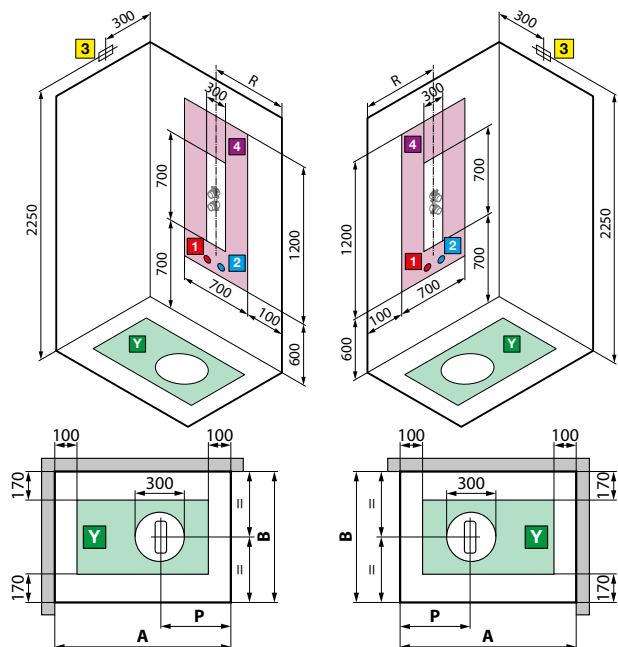

modelo	A ± 2	B ± 2	P	R
A100x80	1000	800	400	450
A120x80	1200	800	500	550
A120x90	1200	900	500	550
A120x100	1200	1000	500	550
2P140x80	1400	800	600	650



40 max
 No inspeccionable
 Não ispezionabile

El producto está certificado de acuerdo con la normativa de compatibilidad electromagnética
EN55014-1
EN55014-2
 O produto é certificado de acordo com os regulamentos de compatibilidade eletromagnética

ATENCIÓN!! Puede ser perjudicial para las personas que utilizan marcapasos
ATENÇÃO!! Pode ser prejudicial para pessoas que usem pacemaker

CARACTERÍSTICAS HIDRÁULICAS
 · Presión requerida 2=5 bar
 · Agua caliente 1/2" / Água quente 1/2"
 · Agua fría 1/2" / Água fría 1/2"
 · Conexión del sifón de Ø 40 mm / Ligaçao sifão de Ø 40 mm

CARACTERÍSTICAS ELÉCTRICAS
CARACTERÍSTICAS ELÉTRICAS
 · Tensión: 220-230 V / Tensão: 220-230 V
 · Frecuencia: 50/60 Hz / Frequência: 50/60 Hz
 · Potencia máxima absorbida / Potencia maxima absorbida: 2600 W
 · Potencia nominal: 2500 W

Debe instalarse un interruptor diferencial de 30 mA con una apertura mínima de los contactos igual a 3 mm. fabricado según la legislación vigente. Deve instalar-se um interruptor diferencial de 30mA com uma abertura mínima dos contactos igual a 3mm. Fabricado segundo as normas.

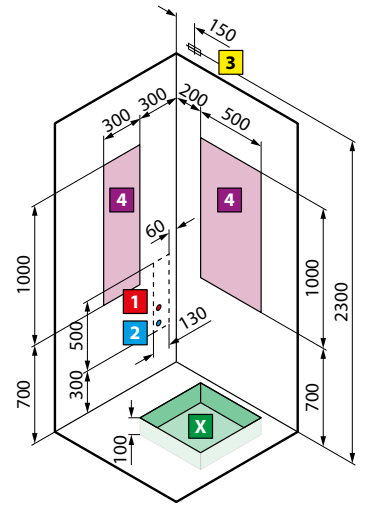
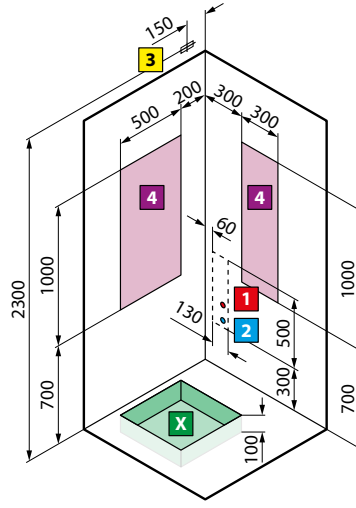
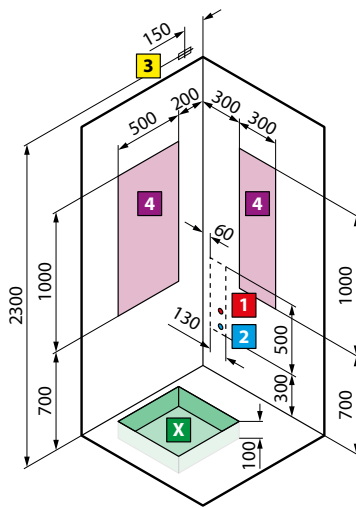
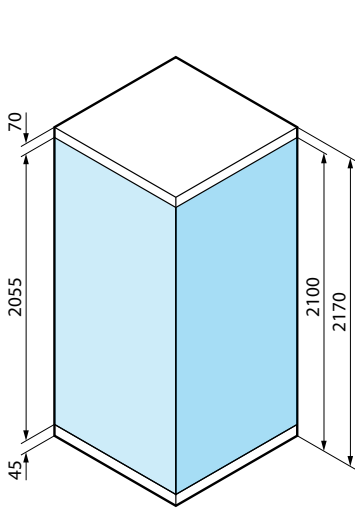

para modelos
A80 - A90 - A100 - GF80 - GF90 - R90 - R100

versión derecha / versão direita versión izquierda / versão esquerda
per mod. **A90x70 - A100x70 - A100x80 - 2P120x80 - 2P120x90**

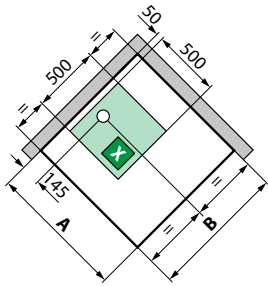

modelo	A ± 3	B ± 3
A80	796	796
A90	896	896
A 100	996	996
GF80	796	796
GF90	896	896

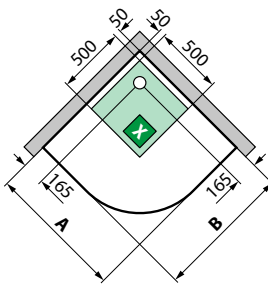

modelo	A ± 3	B ± 3
R90	896	896
R100	996	996

S INSTALACIÓN A MANO IZQUIERDA
INSTALAÇÃO ESQUERDA

D INSTALACIÓN A MANO DERECHA
INSTALAÇÃO DIREITA

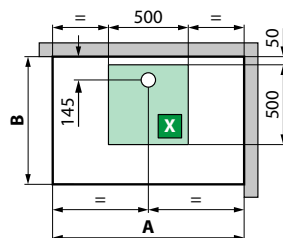
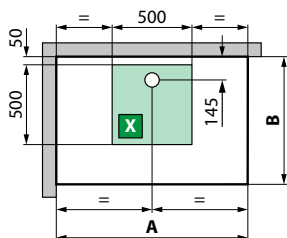

modelo	A ± 3	B ± 3
A90x70	896	696
A100x70	996	696
A100x80	996	796
2P120x80	1196	796
2P120x90	1196	896

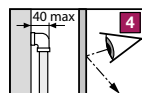
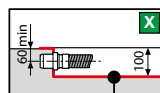
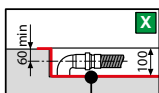

No inspeccionable
Não ispezionabile

ATENCIÓN!! Puede ser perjudicial para las personas que utilizan marcapasos
ATENÇÃO!! Pode ser prejudicial para pessoas que usem pacemaker

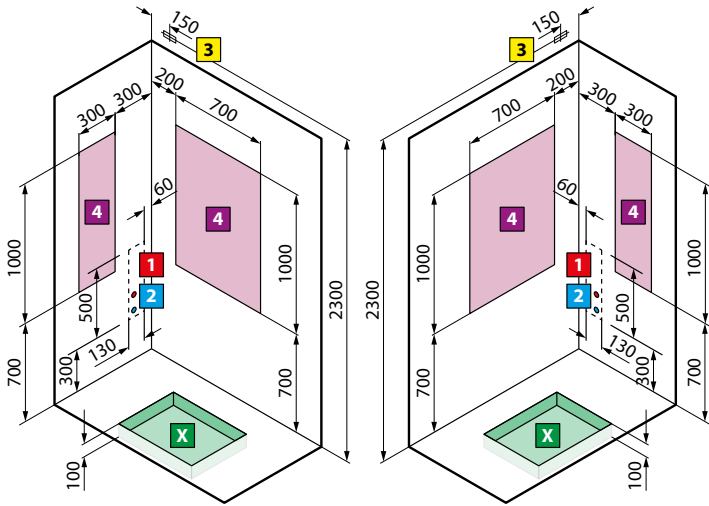

versión izquierda / versão esquerda versión derecha / versão direita

per mod. **2P140x80 - 2P140x90**

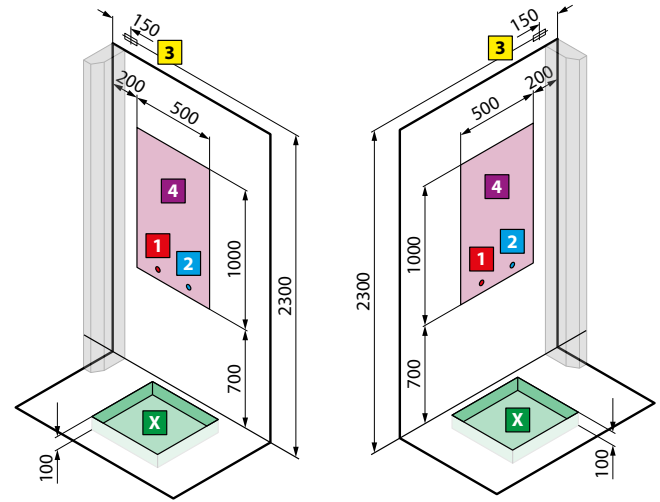

versión izquierda / versão esquerda

per mod. **A100x80**

versión derecha / versão direita

per mod. **A100x80 - 2P120x80**

S INSTALACIÓN A MANO IZQUIERDA
INSTALAÇÃO ESQUERDA

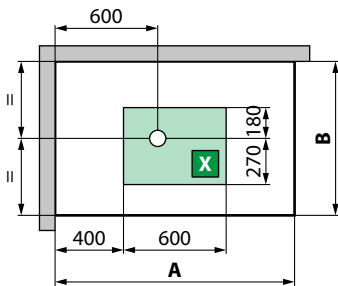

D INSTALACIÓN A MANO DERECHA
INSTALAÇÃO DIREITA

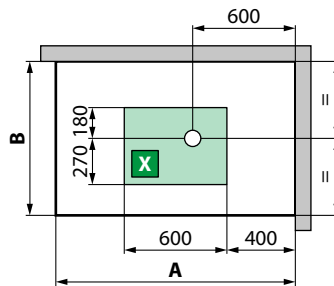

modelo	A ± 3	B ± 3
2P140x80	1394	794
2P140x90	1394	894

S INSTALACIÓN A MANO IZQUIERDA
INSTALAÇÃO ESQUERDA

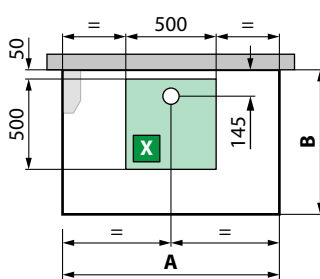

D INSTALACIÓN A MANO DERECHA
INSTALAÇÃO DIREITA

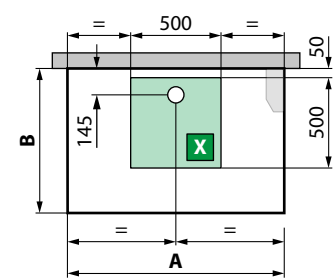

modelo	A ± 3	B ± 3
A+F100x80	996	796
2P+2F120x80	1196	796

CARACTERÍSTICAS HIDRÁULICAS

- Presión requerida 2÷5 bar
- Agua caliente 1/2" / Água quente 1/2"
- Agua fría 1/2" / Água fría 1/2"
- Conexión del sifón de Ø 40 mm / Ligaçãõ sifão de Ø 40 mm

CARACTERÍSTICAS ELÉCTRICAS

- Tensión: 220-230 V / Tensão: 220-230 V
- Frecuencia: 50/60 Hz / Frequência: 50/60 Hz
- Potencia máxima absorbida / Potencia máxima absorbida: 2600 W
- Potencia nominal: 2500 W

Debe instalarse un interruptor diferencial de 30 mA con una apertura mínima de los contactos igual a 3 mm. fabricado según la legislación vigente. Deve instalar-se um interruptor diferencial de 30mA com uma abertura mínima dos contactos igual a 3 mm. Fabricado segundo as normas.

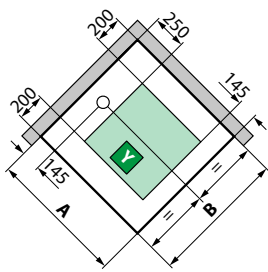
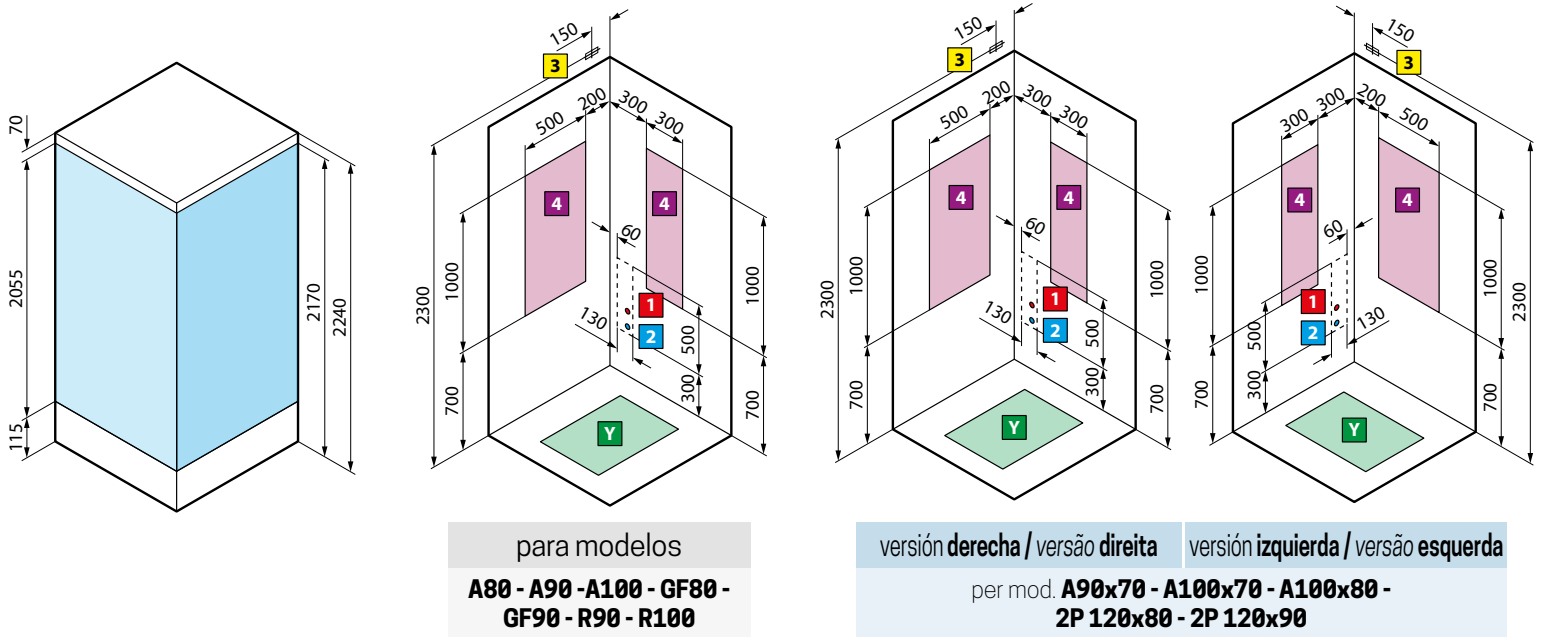

modelo	A ± 4	B ± 4
A80	798	798
A90	898	898
A 100	998	998
GF80	798	798
GF90	898	898

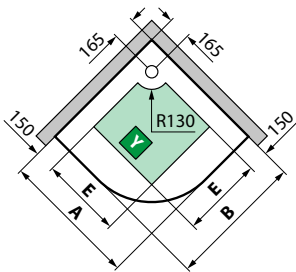

modelo	A ± 4	B ± 4	E
R90	898	898	500
R100	998	998	600

S INSTALACIÓN A MANO IZQUIERDA
INSTALAÇÃO ESQUERDA

D INSTALACIÓN A MANO DERECHA
INSTALAÇÃO DIREITA

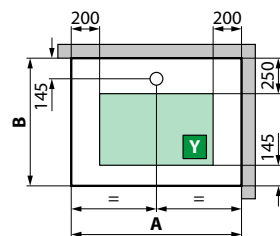
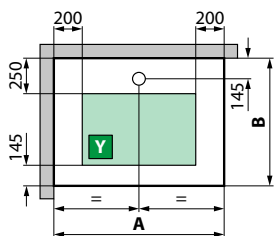

modelo	A ± 4	B ± 4
A90x70	898	698
A100x70	998	698
A100x80	998	798
2P120x80	1198	798
2P120x90	1198	898

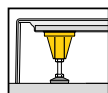
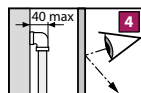
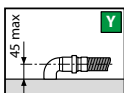

ATENCIÓN!! Puede ser perjudicial para las personas que utilizan marcapasos
ATENÇÃO!! Pode ser prejudicial para pessoas que usam pacemaker

No inspeccionable
Não inspezionabile

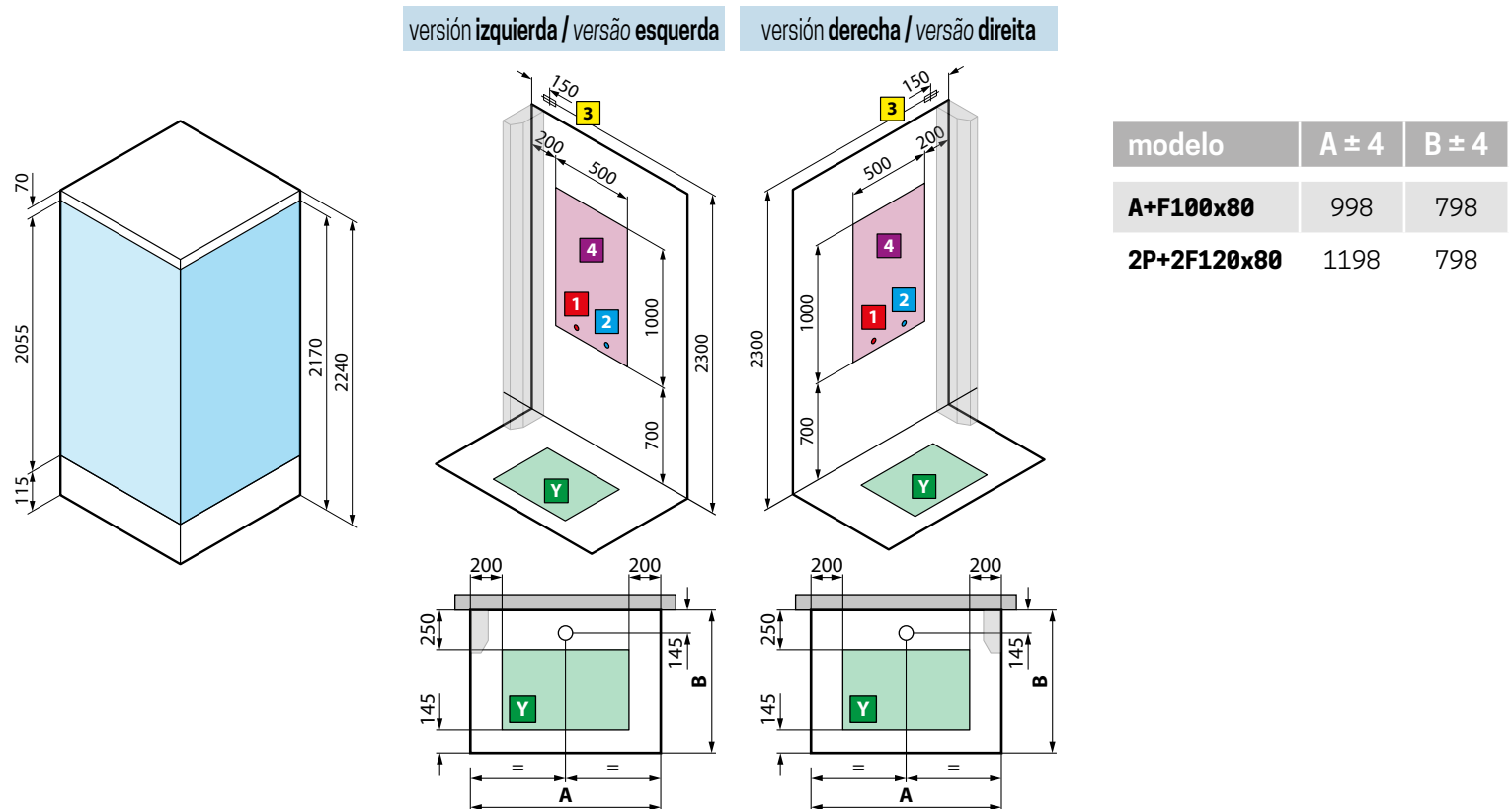
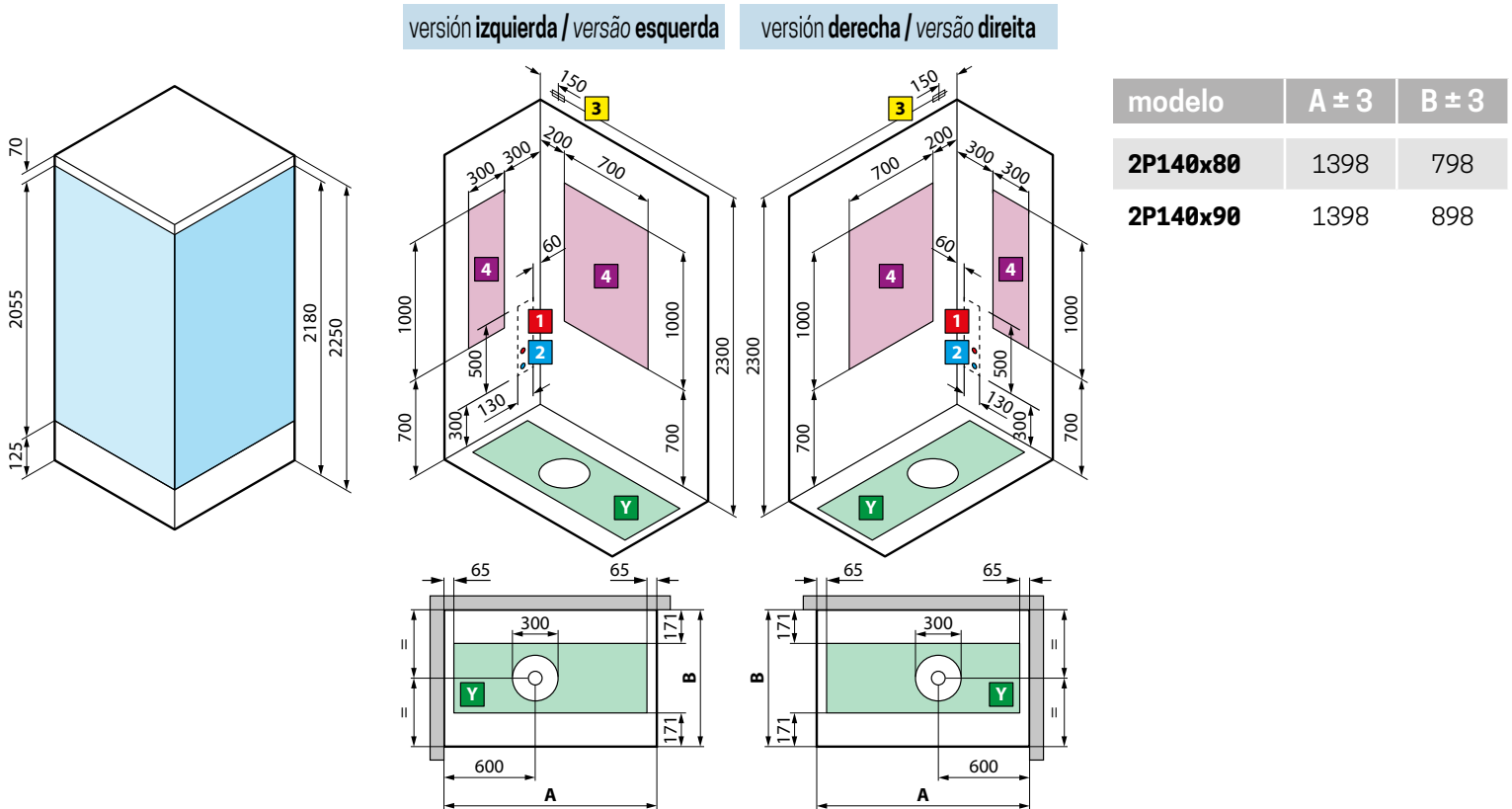

CARACTERÍSTICAS HIDRÁULICAS

- Presión requerida 2÷5 bar
- Agua caliente 1/2" / Água quente 1/2"
- Agua fría 1/2" / Água fría 1/2"
- Conexión del sifón de Ø 40 mm / Ligeação sifão de Ø 40 mm

CARACTERÍSTICAS ELÉCTRICAS

- CARACTERÍSTICAS ELÉTRICAS**
- Tensión: 220-230 V / Tensão: 220-230 V
 - Frecuencia: 50/60 Hz / Frequência: 50/60 Hz
 - Potencia máxima absorbida / Potencia máxima absorbida: 2600 W
 - Potencia nominal: 2500 W

Debe instalarse un interruptor diferencial de 30 mA con una apertura mínima de los contactos igual a 3 mm. fabricado según la legislación vigente. Deve instalar-se um interruptor diferencial de 30mA com uma abertura mínima dos contactos igual a 3 mm. Fabricado segundo as normas.

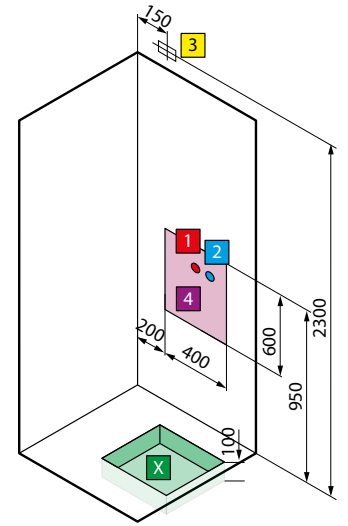
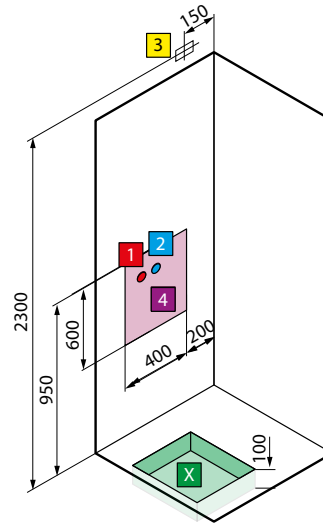
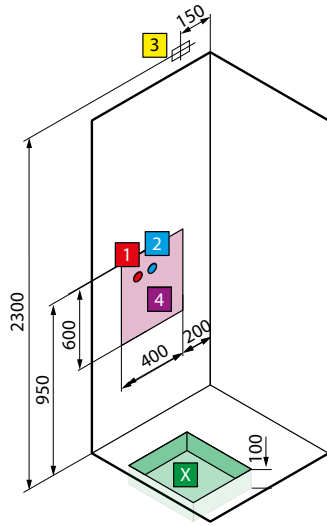
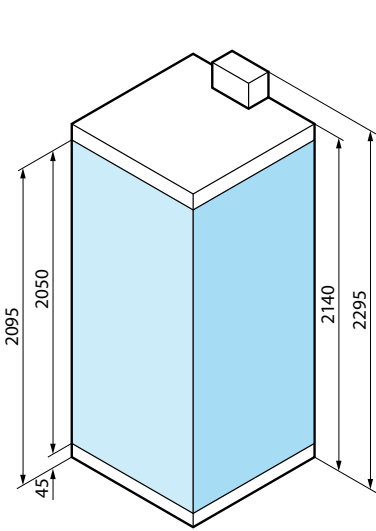

para modelos
GF/A80 - GF/A90 - G90 - R90 - 2P120

versión izquierda / versão esquerda versión derecha / versão direita
para modelos **A100x80 - 2P120x80 - 2P120x90**

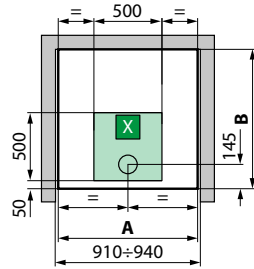
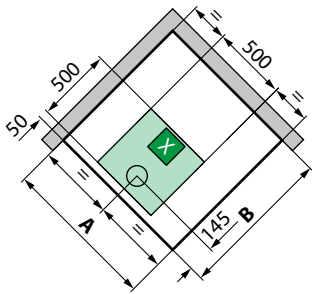

modelo	A ± 4	B ± 4
GF/A80	802	802
GF/A90	902	902
G90	902	902

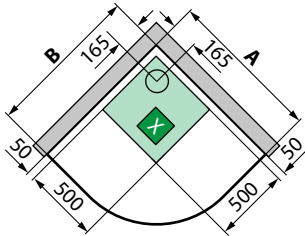

modelo	A ± 4	B ± 4
R90	902	902

S INSTALACIÓN A MANO IZQUIERDA
INSTALAÇÃO ESQUERDA

D INSTALACIÓN A MANO DERECHA
INSTALAÇÃO DIREITA

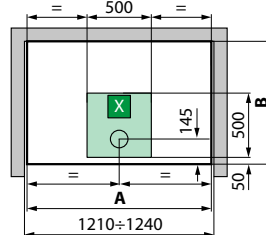
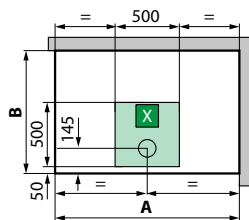
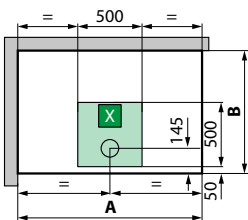

modelo	A ± 4	B ± 4
A100x80	1002	802
2P120x80	1202	802
2P120x90	1202	902
2P120x80/90	1202	902

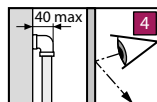
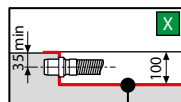
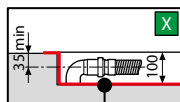

No inspeccionable
Não ispezionabile

ATENCIÓN!! Puede ser perjudicial para las personas que utilizan marcapasos
ATENÇÃO!! Pode ser prejudicial para pessoas que usam pacemaker

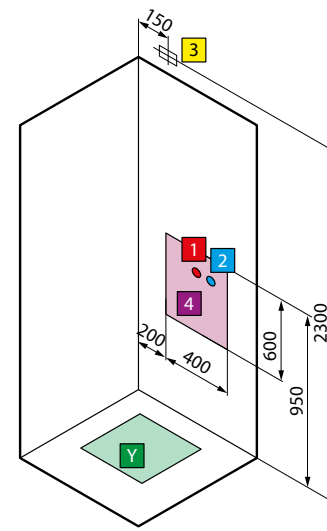
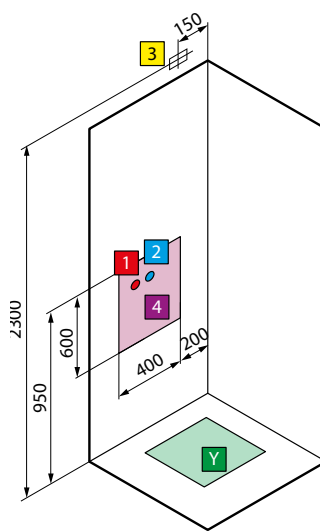
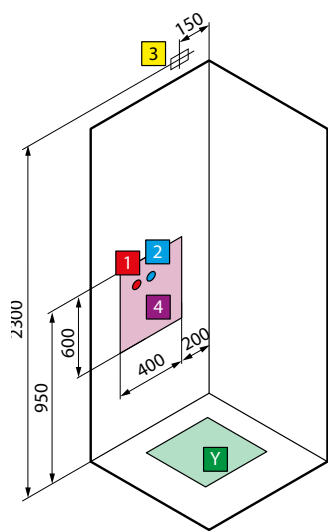
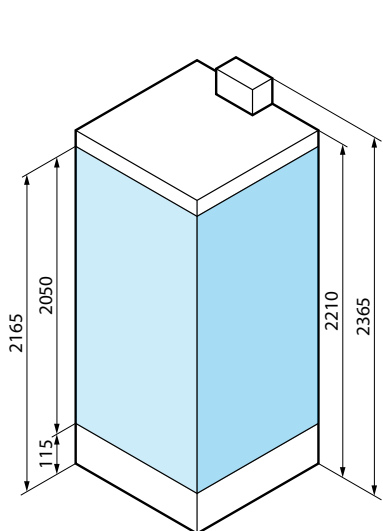

para modelos
GF/A80 - GF/A90 - G90 - R90 - 2P120

versión izquierda / versão esquerda versión derecha / versão direita
para modelos **A100x80 - 2P120x80 - 2P120x90**

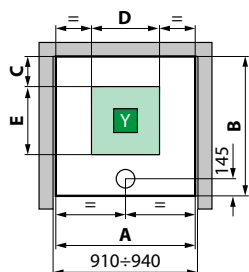
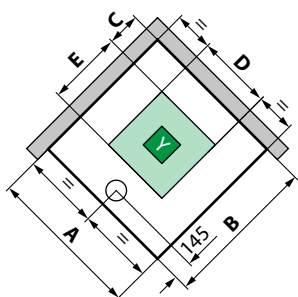

modelo	A ± 4	B ± 4	C	D	E
GF/A80	802	802	150	400	400
GF/A90	902	902	150	500	500
G90	902	902	150	500	500

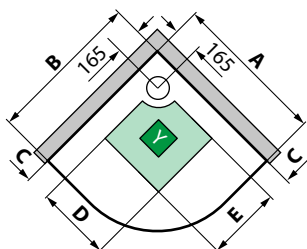

modelo	A ± 4	B ± 4	C	D	E
R90	902 ± 4	902	156	500	500

S INSTALACIÓN A MANO IZQUIERDA
INSTALAÇÃO ESQUERDA

D INSTALACIÓN A MANO DERECHA
INSTALAÇÃO DIREITA

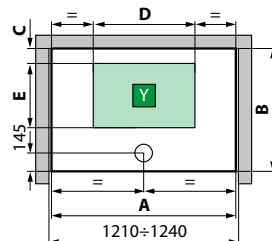
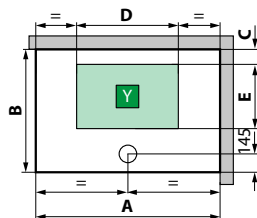
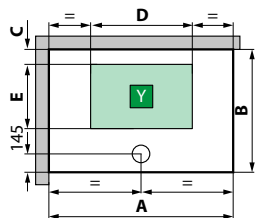

modelo	A ± 4	B ± 4	C	D	E
A100x80	1002	802	150	600	400
2P120x80	1202	802	150	800	400
2P120x90	1202	902	150	800	500
2P120x80/90	1202	902	150	800	500

CARACTERÍSTICAS HIDRÁULICAS

- Presión requerida 2÷5 bar
- Agua caliente 1/2" / Água quente 1/2"
- Agua fría 1/2" / Água fría 1/2"
- Conexión del sifón de Ø 40 mm / Ligação sifão de Ø 40 mm

CARACTERÍSTICAS ELÉCTRICAS

- Tensión: 220-230 V / Tensão: 220-230 V
- Frecuencia: 50/60 Hz / Frequência: 50/60 Hz
- Potencia nominal: 2500 W
- Potencia máxima HAMMAM: 2600 W
- Potencia máxima BASE e HIDRO: 50 W

Debe instalarse un interruptor diferencial de 30 mA con una apertura mínima de los contactos igual a 3 mm. fabricado según la legislación vigente. Deve instalar-se um interruptor diferencial de 30mA com uma abertura mínima dos contactos igual a 3 mm. Fabricado segundo as normas.

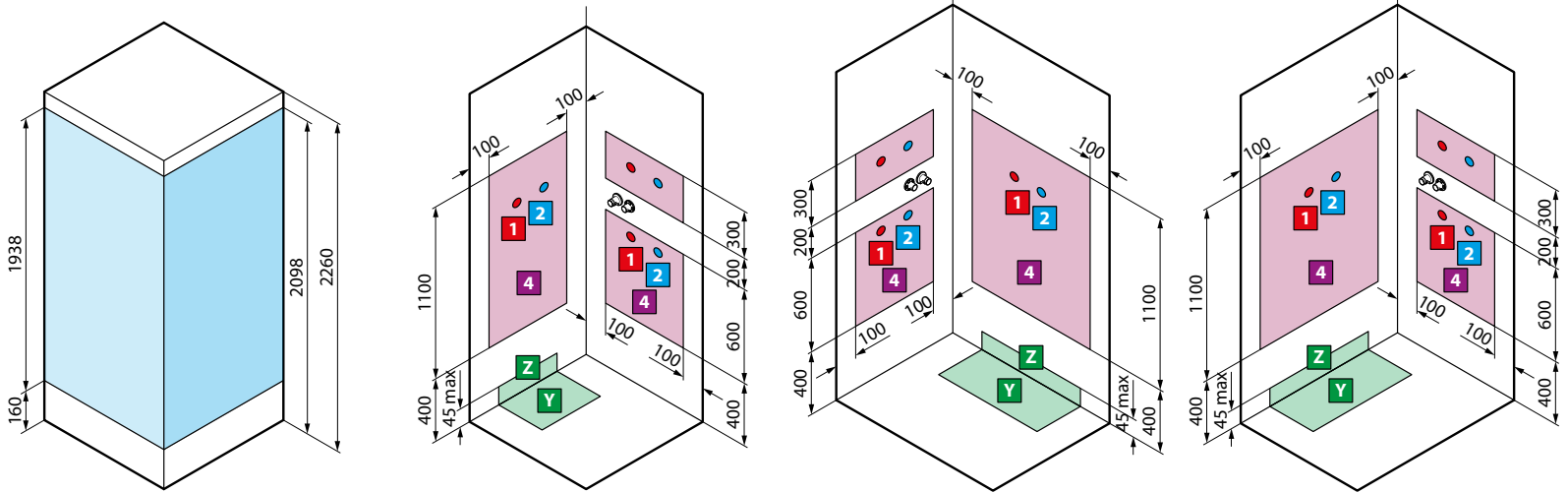

para modelos
A80 - A90 - R90 - GF80 - GF90

versión **izquierda** / versão **esquerda** versión **derecha** / versão **direita**
para modelos **A 90x70 - A 100x70 - A 100x80 - 2P 120x80**

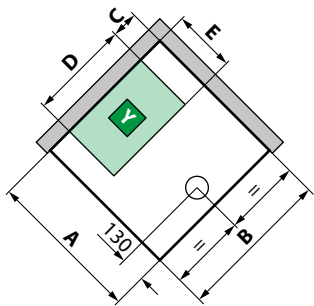

modelo	A ± 5	B ± 5	C	D	E
A80	804	804	200	404	300
A90	904	904	200	504	300
GF80	804	804	200	404	300
GF90	904	904	200	504	300

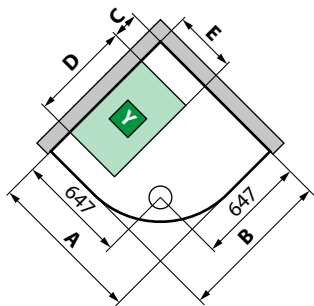

modelo	A ± 5	B ± 5	C	D	E
R90	904	904	200	504	300

S INSTALACIÓN A MANO IZQUIERDA
INSTALAÇÃO ESQUERDA

D INSTALACIÓN A MANO DERECHA
INSTALAÇÃO DIREITA

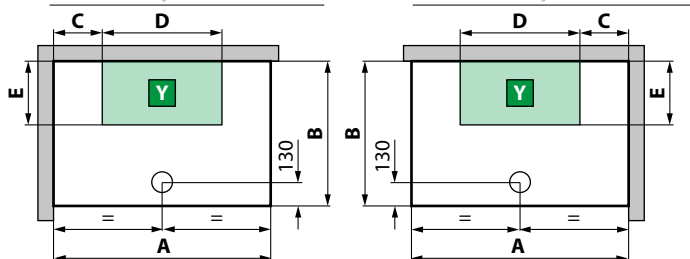

modelo	A ± 5	B ± 5	C	D	E
A90x70	904	704	200	504	300
A100x70	1004	704	200	604	300
A100x80	1004	804	200	604	300
2P120x80	1204	804	200	804	300

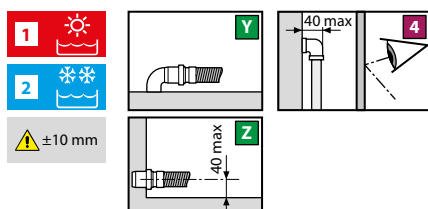

CARACTERÍSTICAS HIDRÁULICAS

- Presión requerida 2÷5 bar
- Agua caliente 1/2" / Água quente 1/2"
- Agua fría 1/2" / Água fría 1/2"
- Conexión del sifón de Ø 40 mm / Ligaçao sifão de Ø 40 mm

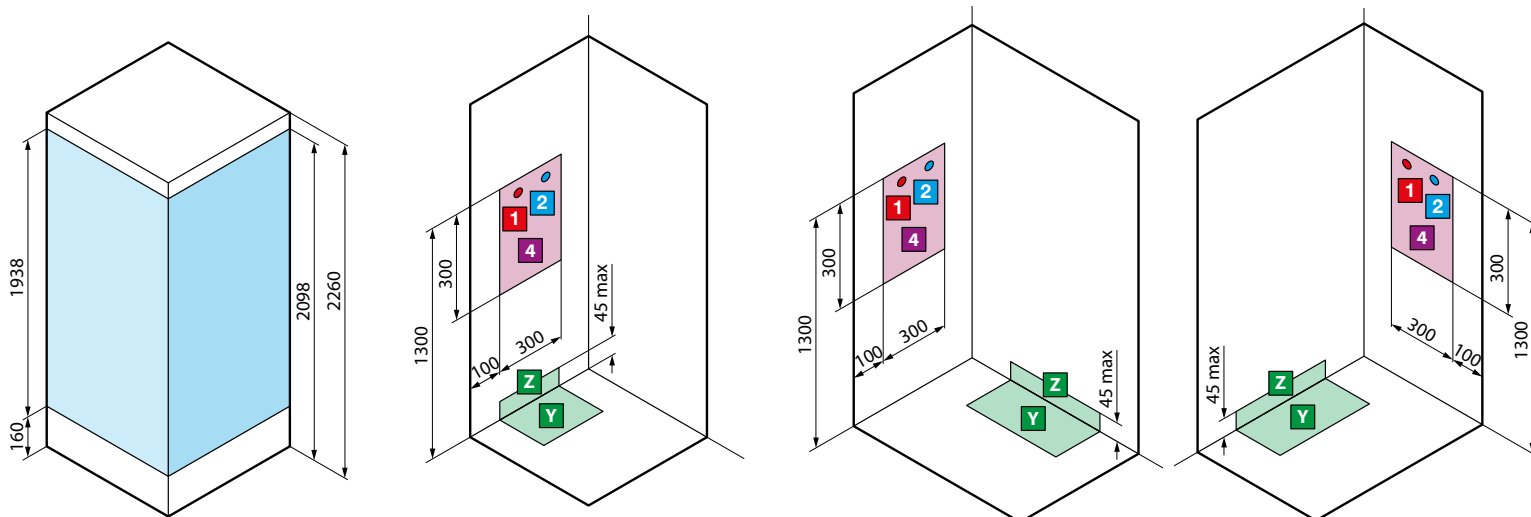

para modelos
A80 - A90 - R90 - GF80 - GF90

versión izquierda / versão esquerda versión derecha / versão direita
para modelos **A 90x70 - A 100x70 - A 100x80 - 2P 120x80**

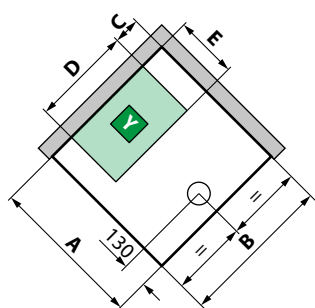

modelo	A ± 5	B ± 5	C	D	E
A80	804	804	200	404	300
A90	904	904	200	504	300
GF80	804	804	200	404	300
GF90	904	904	200	504	300

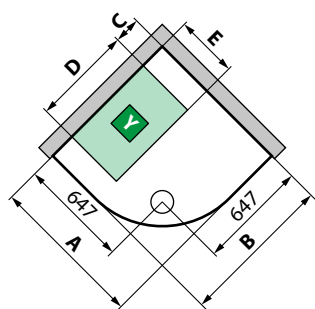

modelo	A ± 5	B ± 5	C	D	E
R90	904	904	200	504	300

S INSTALACIÓN A MANO IZQUIERDA INSTALAÇÃO ESQUERDA

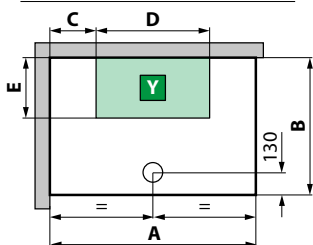

D INSTALACIÓN A MANO DERECHA INSTALAÇÃO DIREITA

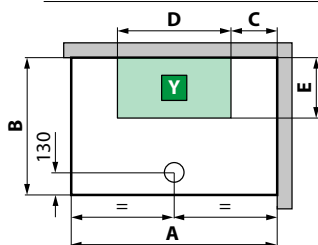

modelo	A ± 5	B ± 5	C	D	E
A90x70	904	704	200	504	300
A100x70	1004	704	200	604	300
A100x80	1004	804	200	604	300
2P120x80	1204	804	200	804	300

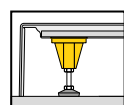
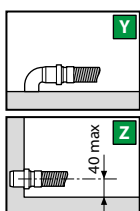

No inspeccionable / Não ispezionabile
En los modelos previstos / Nos modelos previstos

CARACTERÍSTICAS HIDRÁULICAS

- Presión requerida 2÷5 bar
- Agua caliente 1/2" / Água quente 1/2"
- Agua fría 1/2" / Água fria 1/2"
- Conexión del sifón de Ø 40 mm / Ligaçao sifão de Ø 40 mm

REVOLUTION

Práctica

Fácil y rápida de instalar, reduciendo al mínimo los trabajos de albañilería.

La mejor solución para cambiar la vieja bañera o cabina.

Seguridad y robustez

La garantía profesional de un proyecto desarrollado por el equipo técnico de una gran empresa.

Diferentes propuestas de configuración

Máxima funcionalidad para tu baño.
Máximas posibilidades de configuración para un baño elegante y bien equipado.

Novellini facilita el montaje.

Contacta con nosotros para conocer la facilidad de montaje de nuestro producto.



TRATAMIENTOS / TRATAMENTOS





REVOLUTION

REVOLUTION

REVOLUTION **es...**

Una **cabina de ducha** con **mampara**



Una **cabina de ducha** con **armario para lavadora** con cajonera inferior



Una **cabina** con una **mampara de baño** de **espacio abierto**



Un baño equipado a 360°



Una cabina de ducha con armario para lavadora y secadora



Una cabina de ducha con columna multifunción.

REVOLUTION

CON MAMPARAS DE BAÑO / RESGUARDOS DE BANHO

UN SOLO CÓDIGO PARA PEDIR EL KIT, COMPUESTO POR:

- MAMPARA DE BAÑO ZAFIRO 2P (ACABADO CROMO, CRISTAL TRANSPARENTE)
- PLATO DE DUCHA NEW OLYMPIC BLANCO BRILLO
- PANELES DE PARED DE CRISTAL BLANCO



ANCHO 140

Pared posterior baja

Pared posterior alta

Medidas	Código	Precio / Preço	Código	Precio / Preço
140 X 70	KREAC1472P-1K	2.767 €	KREAA1472P-1K	3.137 €
140 X 75	KREAC1452P-1K	2.767 €	KREAA1452P-1K	3.137 €
140 X 80	KREAC1482P-1K	2.807 €	KREAA1482P-1K	3.177 €

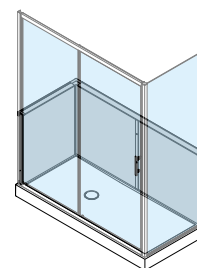

Pared posterior baja

ANCHO 160

Pared posterior baja

Pared posterior alta

Medidas	Código	Precio / Preço	Código	Precio / Preço
160 X 70	KREAC1672P-1K	2.876 €	KREAA1672P-1K	3.246 €
160 X 75	KREAC1652P-1K	2.883 €	KREAA1652P-1K	3.253 €
160 X 80	KREAC1682P-1K	2.935 €	KREAA1682P-1K	3.305 €

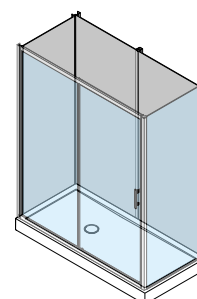

Pared posterior alta

ANCHO 170

Pared posterior baja

Pared posterior alta

Medidas	Código	Precio / Preço	Código	Precio / Preço
170 X 70	KREAC1772P-1K	2.907 €	KREAA1772P-1K	3.275 €
170 X 75	KREAC1752P-1K	2.934 €	KREAA1752P-1K	3.304 €
170 X 80	KREAC1782P-1K	2.961 €	KREAA1782P-1K	3.331 €

REVOLUTION

CON MAMPARA EN ESPACIO ABIERTO

UN SOLO CÓDIGO PARA PEDIR EL KIT, COMPUESTO POR:

- GIADA H (ACABADO CROMO, CRISTAL TRANSPARENTE)
- PLATO DE DUCHA NEW OLYMPIC BLANCO BRILLO
- PANELES DE PARED DE CRISTAL BLANCO



ANCHO 140

Pared posterior baja

Medidas	Código	Precio / Preço	Código	Precio / Preço
140 X 70	KREAC147HH-1K	2.642 €	KREAA147HH-1K	3.009 €
140 X 75	KREAC145HH-1K	2.654 €	KREAA145HH-1K	3.024 €
140 X 80	KREAC148HH-1K	2.695 €	KREAA148HH-1K	3.063 €

Pared posterior alta

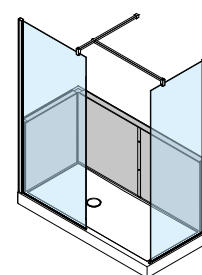

Pared posterior baja

ANCHO 160

Pared posterior baja

Medidas	Código	Precio / Preço	Código	Precio / Preço
160 X 70	KREAC167HH-1K	2.721 €	KREAA167HH-1K	3.090 €
160 X 75	KREAC165HH-1K	2.744 €	KREAA165HH-1K	3.114 €
160 X 80	KREAC168HH-1K	2.796 €	KREAA168HH-1K	3.166 €

Pared posterior alta

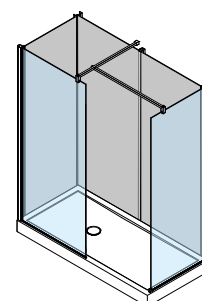

Pared posterior alta

ANCHO 170

Pared posterior baja

Medidas	Código	Precio / Preço	Código	Precio / Preço
170 X 70	KREAC177HH-1K	2.749 €	KREAA177HH-1K	3.119 €
170 X 75	KREAC175HH-1K	2.791 €	KREAA175HH-1K	3.161 €
170 X 80	KREAC178HH-1K	2.816 €	KREAA178HH-1K	3.187 €

Pared posterior alta



REVOLUTION CON COLUMNA MULTIFUNCIÓN

UN SOLO CÓDIGO PARA PEDIR EL KIT, COMPUESTO POR:

- MAMPARA DE BAÑO ZAFIRO 2P (ACABADO CROMO, CRISTAL TRANSPARENTE)
- PLATO DE DUCHA NEW OLYMPIC BLANCO BRILLO
- PANELES DE PARED DE CRISTAL BLANCO

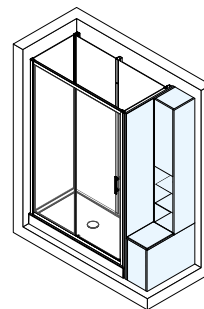
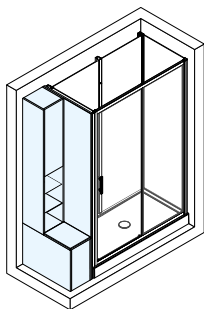

Medidas	COLUMNA BLANCA IZQUIERDA		COLUMNA BLANCA DERECHA	
	Código	Precio / Preço	Código	Precio / Preço
170 X 70	KREAA1772P08-1KA	4.466 €	KREAA1772P05-1KA	4.466 €
170 X 80	KREAA1782P10-1KA	4.625 €	KREAA1782P07-1KA	4.625 €

Medidas	COLUMNA BURLINGTON IZQUIERDA		COLUMNA BURLINGTON DERECHA	
	Código	Precio / Preço	Código	Precio / Preço
170 X 70	KREAA1772P08-1KN	4.466 €	KREAA1772P05-1KN	4.466 €
170 X 80	KREAA1782P10-1KN	4.625 €	KREAA1782P07-1KN	4.625 €

OPCIONAL

TAPA-PANEL DE TERMINACIÓN (de 5-25 cm.) de 206,5 cm de altura (recortable a medida)

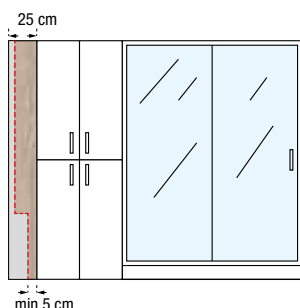

Color Cores	Código	Precio / Preço
Blanco Branco	REVO06A	290 €
Blanco rayado Branco listrado	REVO06I	290 €
Burlington	REVO06N	290 €
Grain	REVO06M	290 €
wengue wengue	REVO06V	290 €

La tapa-panel de terminación se puede recortar y permite la instalación de la Revolution incluso en situaciones especiales en las entregas a pared.

La medida mínima de la tapa es de 5 cm. después del recorte.



REVOLUTION CON ARMARIO PARA LAVADORA O PARA LAVADORA Y SECADORA

UN SOLO CÓDIGO PARA PEDIR EL KIT, COMPUESTO POR:

- MAMPARA DE BAÑO ZAFIRO 2P (ACABADO CROMO, CRISTAL TRANSPARENTE)
- PLATO DE DUCHA NEW OLYMPIC BLANCO BRILLO
- PANELES DE PARED DE CRISTAL BLANCO
- ARMARIO PARA LAVADORA O PARA LAVADORA Y SECADORA

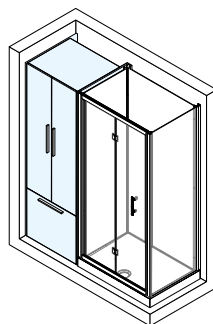

Medidas	ARMARIO PARA LAVADORA BLANCO		ARMARIO PARA LAVADORA BURLINGTON	
	Código	Precio / Preço	Código	Precio / Preço
170 X 70	KREAA177S001-1KA	4.675 €	KREAA177S001-1KN	4.675 €
170 X 80	KREAA178S002-1KA	4.790 €	KREAA178S002-1KN	4.790 €

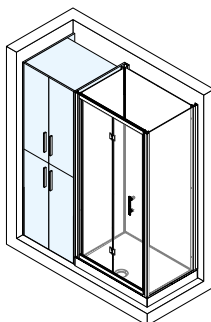

Medidas	ARMARIO PARA LAVADORA Y SECADORA BLANCO		ARMARIO PARA LAVADORA Y SECADORA BURLINGTON	
	Código	Precio / Preço	Código	Precio / Preço
170 X 70	KREAA177S003-1KA	4.441 €	KREAA177S003-1KN	4.526 €
170 X 80	KREAA178S004-1KA	4.641 €	KREAA178S004-1KN	4.641 €

OPCIONAL

ACCESORIOS ARMARIO

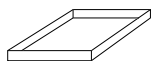

BANDEJA PARA DETERGENTES

200 x 460 x H 30

Código	Precio / Preço
REVB11A	142 €

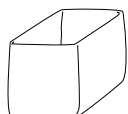

CESTA PARA LA COLADA

360 x 460 x H 360

Código	Precio / Preço
REVB11B	262 €

TAPA-PANEL DE TERMINACIÓN (DE 5-25 CM.) DE 206,5 CM DE ALTURA (RECORTABLE A MEDIDA)

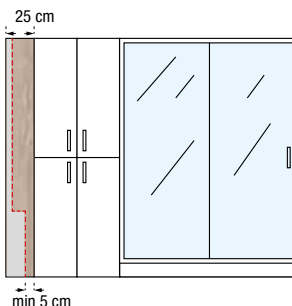

Color Cores	Código	Precio / Preço
Blanco Branco	REVO06A	290 €
Blanco rayado Branco listrado	REVO06I	290 €
Burlington	REVO06N	290 €
Grain	REVO06M	290 €
wengue wengue	REVO06V	290 €

MODELO DE PEDIDO

COMO PERSONALIZAR TU REVOLUTION EN 4 PASOS



1	PLATOS DE DUCHA BASES DE CHUVEIRO p. 445		COD.
		ZEPHYROS 2P	COD.
2	MAMPARAS DE BAÑO RESGUARDOS DE BANHEIRAS p. 446	ZEPHYROS 2A	COD.
		ZEPHYROS F	COD.
2	ESPACIOS ABIERTOS ESPAÇOS ABERTOS p. 448	GIADA H1	COD.
		GIADA H2	COD.
		GIADA HA	COD.
3	PANELES A PARED PAINÉIS DE PAREDE p. 449		COD.
		COLUMNAS / COLUNAS	COD.
		ASIENTO/ASSENTO	COD.
4	ACCESORIOS ACESSÓRIOS p. 450	ESPEJO/ESPELHO	COD.
		REPOSAPIÉS/APOIA-PÉS	COD.
		AGARRADERO/PEGA	COD.
		CAJA PARA SUJETAR GRIFERÍA CAIXA PARA SEGURAR TORNEIRAS	COD.

1 PLATOS DE DUCHA/BASES DE CHUVEIRO - OLYMPIC PLUS

BORDE / REBORDO 4,5 CM

con antideslizante
com antiderrapante

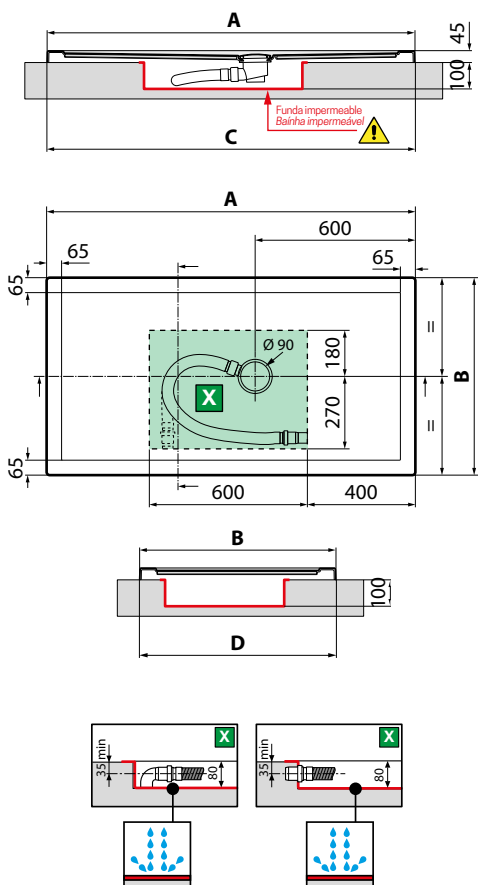

Medidas	Código	Selección de color / precio Seleção de Cores de acabados / Preço						Código	30
		30	79	11	27	29	28		
AxB* ± 2 mm	CxD** ± 3 mm	Blanco Branco	Blanco mate Branco mate	Beige	Corda	Gris	Negro mate		Blanco Branco
120x70	1194x692 1196x694	OL120704-	294 €	469 €	496 €	496 €	496 €	OL120704A-	434 €
120x80	1194x792 1196x794	OL801204-	300 €	475 €	506 €	506 €	506 €	OL801204A-	440 €
120x90	1194x892 1196x894	OL120904-	323 €	498 €	530 €	530 €	530 €	OL120904A-	464 €
140x70	1392x692 1394x694	OL140704-	315 €	491 €	519 €	519 €	519 €	OL140704A-	455 €
140x75	1392x742 1394x744	OL140754-	315 €	491 €	519 €	519 €	519 €	OL140754A-	455 €
140x80	1392x792 1394x794	OL140804-	341 €	516 €	546 €	546 €	546 €	OL140804A-	481 €
140x90	1392x892 1394x894	OL140904-	374 €	549 €	582 €	582 €	582 €	OL140904A-	514 €
160x70	1592x692 1594x694	OL160704-	347 €	522 €	554 €	554 €	554 €	OL160704A-	487 €
160x75	1592x742 1594x744	OL160754-	354 €	530 €	562 €	562 €	562 €	OL160754A-	495 €
160x80	1592x792 1594x794	OL160804-	391 €	566 €	601 €	601 €	601 €	OL160804A-	532 €
160x90	1592x892 1594x894	OL160904-	400 €	576 €	612 €	612 €	612 €	OL160904A-	540 €
170x70	1692x692 1694x694	OL170704-	358 €	534 €	566 €	566 €	566 €	OL170704A-	498 €
170x75	1692x742 1694x744	OL170754-	386 €	561 €	596 €	596 €	596 €	OL170754A-	527 €
170x80	1692x792 1694x794	OL170804-	396 €	572 €	608 €	608 €	608 €	OL170804A-	537 €
170x90	1692x892 1694x894	OL170904-	422 €	597 €	633 €	633 €	633 €	OL170904A-	562 €
180x75	1792x742 1794x744	OL180754-	402 €	578 €	614 €	614 €	614 €	OL180754A-	543 €
180x80	1792x792 1794x794	OL180804-	424 €	599 €	635 €	635 €	635 €	OL180804A-	565 €



BORDE / REBORDO 12,5 CM

con antideslizante
com antiderrapante

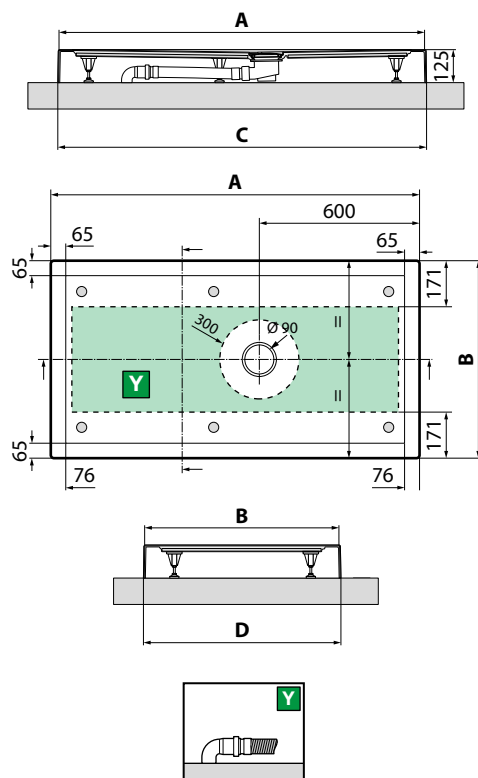

Medidas	Código	Selección de color / precio Seleção de Cores de acabados / Preço						Código	30
		30	79	11	27	29	28		
AxB* ± 2 mm	CxD** ± 3 mm	Blanco Branco	Blanco mate Branco mate	Beige	Corda	Gris	Negro mate		Blanco Branco
120x70	1194x692 1200x698	OL1207011-	294 €	469 €	496 €	496 €	496 €	OL1207011A-	434 €
120x80	1194x792 1200x798	OL8012011-	300 €	475 €	506 €	506 €	506 €	OL8012011A-	440 €
120x90	1194x892 1200x898	OL1209011-	323 €	498 €	530 €	530 €	530 €	OL1209011A-	464 €
140x70	1392x692 1398x698	OL1407011-	315 €	491 €	519 €	519 €	519 €	OL1407011A-	455 €
140x75	1392x742 1398x748	OL1407511-	315 €	491 €	519 €	519 €	519 €	OL1407511A-	455 €
140x80	1392x792 1398x798	OL1408011-	341 €	516 €	546 €	546 €	546 €	OL1408011A-	481 €
140x90	1392x892 1398x898	OL1409011-	374 €	549 €	582 €	582 €	582 €	OL1409011A-	514 €
160x70	1592x692 1598x698	OL1607011-	347 €	522 €	554 €	554 €	554 €	OL1607011A-	487 €
160x75	1592x742 1598x748	OL1607511-	354 €	530 €	562 €	562 €	562 €	OL1607511A-	495 €
160x80	1592x792 1598x798	OL1608011-	391 €	566 €	601 €	601 €	601 €	OL1608011A-	532 €
160x90	1592x892 1598x898	OL1609011-	400 €	576 €	612 €	612 €	612 €	OL1609011A-	540 €
170x70	1692x692 1698x698	OL1707011-	358 €	534 €	566 €	566 €	566 €	OL1707011A-	498 €
170x75	1692x742 1698x748	OL1707511-	386 €	561 €	596 €	596 €	596 €	OL1707511A-	527 €
170x80	1692x792 1698x798	OL1708011-	396 €	572 €	608 €	608 €	608 €	OL1708011A-	537 €
170x90	1692x892 1698x898	OL1709011-	422 €	597 €	633 €	633 €	633 €	OL1709011A-	562 €
180x75	1792x742 1798x748	OL1807511-	402 €	578 €	614 €	614 €	614 €	OL1807511A-	543 €
180x80	1792x792 1798x798	OL1808011-	424 €	599 €	635 €	635 €	635 €	OL1808011A-	565 €

X Altura necesaria empotrada en el suelo para el desagüe H100 mm

Y Área disponible de desagüe por encima del pavimento

2 MAMPARAS DE BAÑO / RESGUARDOS DE BANHEIRAS



PUERTA / PORTA

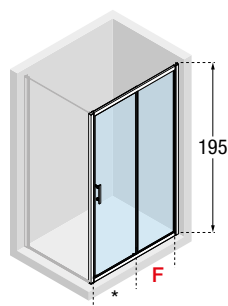

Reversible
Reversível

ZEPHYROS 2P para instalar entre paredes o con panel fijo lateral

Medidas			Código	Selección Cristales Seleção Vidros				Selección de perfiles Seleção de perfis			
Medidas extensibilidad Medidas extensibilidade	Fijo frontal Fixo frontal	Entrada		1	4	11	91	U	B	K	H
A	F1	*		Transparente	Satinado Fosco	Niva	Serigrafía Strip	Blanco mate Branco mate	Silver Abrillantado	Cromo	Negro mate
116↔122	54	47	ZEP22P116-					832 €	925 €	1.018 €	1.018 €
136↔142	64	57	ZEP22P136-	+ 40 €	+ 40 €	+ 40 €		909 €	1.002 €	1.095 €	1.095 €

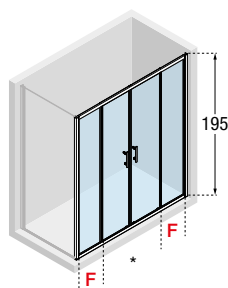

Reversible
Reversível

ZEPHYROS 2A para instalar entre paredes o con panel fijo lateral

Medidas			Código	Selección Cristales Seleção Vidros				Selección de perfiles Seleção de perfis			
Medidas extensibilidad Medidas extensibilidade	Fijo frontal Fixo frontal	Entrada		1	4	11	91	U	B	K	H
A	F1	*		Transparente	Satinado Fosco	Niva	Serigrafía Strip	Blanco mate Branco mate	Silver Abrillantado	Cromo	Negro mate
146↔152	35	54	ZEP22A146-					1.102 €	1.216 €	1.328 €	1.328 €
156↔162	38	59	ZEP22A156-					1.116 €	1.229 €	1.343 €	1.343 €
166↔172	40	64	ZEP22A166-	+ 40 €	+ 40 €	+ 40 €		1.133 €	1.246 €	1.359 €	1.359 €
176↔182	43	69	ZEP22A176-					1.149 €	1.261 €	1.376 €	1.376 €

PARA INSTALAR ENTRE PAREDES

Datos técnicos para la instalación ver pág. 460

Cuando la medida de luz es mayor que la medida STANDARD pedir los perfiles expansores adicionales (ver texto al pie de página)

PARA INSTALAR EN ÁNGULO

Datos técnicos para la instalación ver pág. 460

PEDIR UN PANEL FIJO

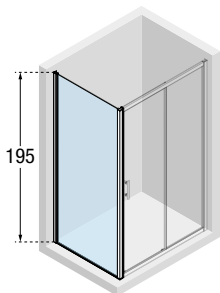

Reversible
Reversível

ZEPHYROS F

Medidas		Código	Selección Cristales Seleção Vidros				Selección de perfiles / Precio Seleção de perfis / Preço			
Extensibilidad	extensibilidad / extensibilidade		1	68	11	54	A	B	K	H
			Transpa- rente	Serigrafía Zephyros 1	Niva	Fumé gris	Blanco Branco	Silver Abrillantado	Cromo	Negro mate
70	68↔71	ZEPHYRF68-					343 €	373 €	402 €	402 €
75	73↔76	ZEPHYRF73-		+ 40 €	+ 40 €	+ 106 €	343 €	373 €	402 €	402 €
80	78↔81	ZEPHYRF78-					358 €	386 €	416 €	416 €
90	88↔91	ZEPHYRF88-					373 €	402 €	429 €	429 €

PARA INSTALAR A UNA PARED

Datos técnicos para la instalación ver pág. 460

PEDIR DOS FIJOS LATERALES

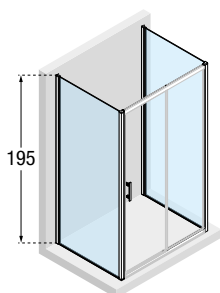

Reversible
Reversível

ZEPHYROS F

Medidas		Código	Selección Cristales Seleção Vidros				Selección de perfiles / Precio Seleção de perfis / Preço			
Extensibilidad	extensibilidad / extensibilidade		1	68	11	54	A	B	K	H
			Transpa- rente	Serigrafía Zephyros 1	Niva	Fumé gris	Blanco Branco	Silver Abrillantado	Cromo	Negro mate
70	68↔71	ZEPHYRF68-					343 €	373 €	402 €	402 €
75	73↔76	ZEPHYRF73-		+ 40 €	+ 40 €	+ 106 €	343 €	373 €	402 €	402 €
80	78↔81	ZEPHYRF78-					358 €	386 €	416 €	416 €
90	88↔91	ZEPHYRF88-					373 €	402 €	429 €	429 €

PERFIL DE COMPENSACIÓN

Datos técnicos para la instalación ver pág. 460

PERFIL DE COMPENSACIÓN + 15 mm

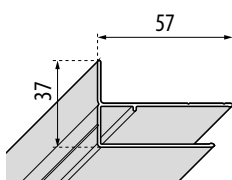

Perfiles Perfis	Código	Precio / Preço
Blanco Branco	P05BHCST-A	82 €
Silver Abrillantado	P05BHCST-B	91 €
Cromo	P05BHCST-K	101 €
Negro mate	P05BHCST-H	101 €

PERFIL DE COMPENSACIÓN + 25 mm

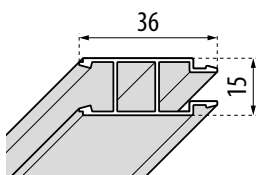

Perfiles Perfis	Código	Precio / Preço
Blanco Branco	P05HAAST3-A	68 €
Silver Abrillantado	P05HAAST3-B	75 €
Cromo	P05HAAST3-K	84 €
Negro mate	P05HAAST3-H	84 €

PERFIL DE COMPENSACIÓN - GIADA H + 15 mm

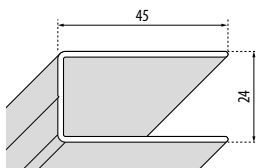

Perfiles Perfis	Código	Precio / Preço
Blanco Branco	P01BLMOST-A	72 €
Silver Abrillantado	P01BLMOST-B	80 €
Cromo	P01BLMOST-K	89 €

TAPA-PANEL DE TERMINACIÓN

(de 5-25 cm.) de 206,5 cm de altura (recortable a medida)

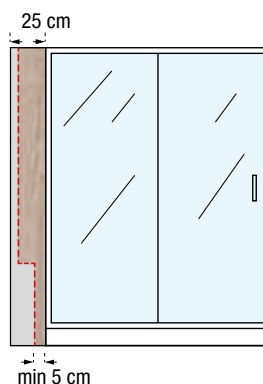

La tapa-panel de terminación se puede recortar y permite la instalación de la Revolution incluso en situaciones especiales en las entregas a pared. La medida mínima de la tapa es de 5 cm. después del recorte.

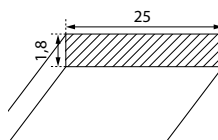

Color Cores	Código	Precio / Preço
Blanco Branco	REVO07A	290 €
Blanco rayado Branco listrado	REVO07I	290 €
Burlington	REVO07N	290 €
Grain	REVO07M	290 €
wengue wengue	REVO07V	290 €

2 ESPACIOS ABIERTOS/ESPAÇOS ABERTOS INSTALABLE SÓLO EN LA VERSIÓN EN ÁNGULO

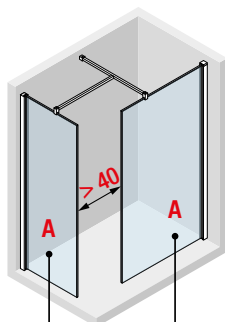

GIADA H
LADO CORTO

GIADA H
LADO LARGO

Para esta composición pasar pedido de: GIADA H + GIADA H

Reversible
Reversível

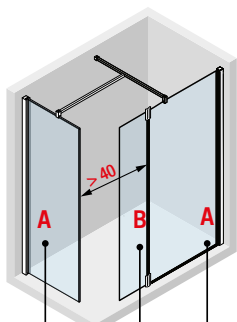

GIADA H
LADO CORTO

GIADA H
LADO LARGO

GIADA HA
PUERTA GIRATORIA

Para esta composición pasar pedido de:
GIADA H + GIADA H + GIADA HA

Reversible
Reversível

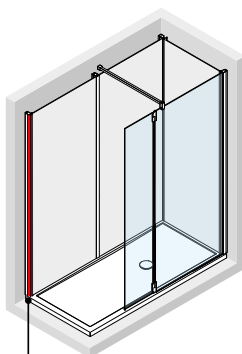

KIT DE ACABADO ESPECIAL

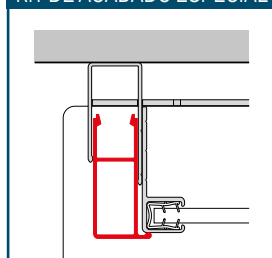

GIADA H LADO LARGO

Datos técnicos para la instalación ver pág. 460

Medidas		Código	Selección Cristales Seleção Vidros		Selección de color / precio Seleção de Cores de acabados / Preço		
Misura consigliata piatto	Medida del fijo		1	44	A	B	K
ancho	A		Transparente	banda satinada	Blanco Branco	Silver Abrillantado	Cromo
120	67↔68,5	GIADAH70-			528 €	582 €	643 €
	77↔78,5	GIADAH80-			555 €	608 €	670 €
140	87↔88,5	GIADAH90-			569 €	623 €	684 €
160	107↔108,5	GIADAH110-		+ 40 €	602 €	663 €	730 €
170	117↔118,5	GIADAH120-			617 €	676 €	744 €
180	127↔128,5	GIADAH130-			630 €	691 €	758 €

GIADA H LADO CORTO

Datos técnicos para la instalación ver pág. 460

Medidas		Código	Selección Cristales Seleção Vidros		Selección de color / precio Seleção de Cores de acabados / Preço		
Misura consigliata piatto	Medida del fijo		1	44	A	B	K
ancho	A		Transparente	banda satinada	Blanco Branco	Silver Abrillantado	Cromo
70	67↔68,5	GIADAH70-			528 €	582 €	643 €
75	72↔73,5	GIADAH75-			541 €	596 €	656 €
80	77↔78,5	GIADAH80-		+ 40 €	555 €	608 €	670 €
90	87↔88,5	GIADAH90-			569 €	623 €	684 €

GIADA HA PUERTA GIRATORIA/PORTA GIRATORIA

Medidas		Código	Selección Cristales/Seleção Vidros	
Misura consigliata piatto	Medidas extensibilidad Medidas extensibilidade		1	K
ancho	B		Transparente	Cromo
70	37	GIADAHA37-		212 €
70	37	GIADAHA37D-	-	212 €
70	37	GIADAHA37S-	-	212 €

Para versión sin GIADA H LADO CORTO pedir el **KIT DE ACABADO ESPECIAL**

Perfiles/Perfis	Código	Precio / Preço
Blanco/Branco	P51REGHST-A	167 €
Silver/Abrillantado	P51REGHST-B	186 €
Cromo	P51REGHST-K	205 €

3 PANELES A PARED

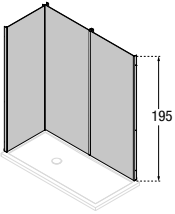
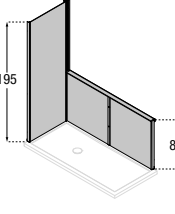
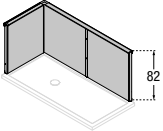
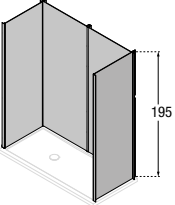
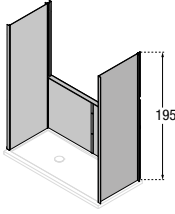
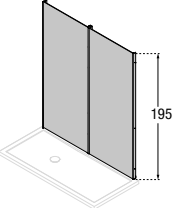
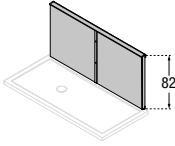
Combinaciones	Profundidad	extensibilidad / código					Blanco	Negro	Precio / Preço	
		120 cm	140 cm	160 cm	170 cm	180 cm	Branco	-H		
ÁNGULO										
	70	REVAA12070	REVAA14070	REVAA16070	REVAA17070	-			1.256 €	
	75	-	REVAA14075	REVAA16075	REVAA17075	REVAA18075			1.256 €	
	80	REVAA12080	REVAA14080	REVAA16080	REVAA17080	REVAA18080			1.256 €	
	90	REVAA12090	REVAA14090	REVAA16090	REVAA17090	-			1.256 €	
	70	REVAB12070	REVAB14070	REVAB16070	REVAB17070	-			1.110 €	
	75	-	REVAB14075	REVAB16075	REVAB17075	REVAB18075			1.110 €	
	80	REVAB12080	REVAB14080	REVAB16080	REVAB17080	REVAB18080			1.110 €	
	90	REVAB12090	REVAB14090	REVAB16090	REVAB17090	-			1.110 €	
	70	REVAC12070	REVAC14070	REVAC16070	REVAC17070	-			887 €	
	75	-	REVAC14075	REVAC16075	REVAC17075	REVAC18075			887 €	
	80	REVAC12080	REVAC14080	REVAC16080	REVAC17080	REVAC18080			887 €	
	90	REVAC12090	REVAC14090	REVAC16090	REVAC17090	-			887 €	
	ENTRE PAREDES									
	SÓLO ZEPHYROS									
		70	REVNA12070	REVNA14070	REVNA16070	REVNA17070	-			1.625 €
75		-	REVNA14075	REVNA16075	REVNA17075	REVNA18075			1.625 €	
80		REVNA12080	REVNA14080	REVNA16080	REVNA17080	REVNA18080			1.625 €	
90		REVNA12090	REVNA14090	REVNA16090	REVNA17090	-			1.625 €	
70		REVNB12070	REVNB14070	REVNB16070	REVNB17070	-			1.478 €	
	75	-	REVNB14075	REVNB16075	REVNB17075	REVNB18075			1.478 €	
	80	REVNB12080	REVNB14080	REVNB16080	REVNB17080	REVNB18080			1.478 €	
	90	REVNB12090	REVNB14090	REVNB16090	REVNB17090	-			1.478 €	
	ENTRE PAREDES									
	SÓLO ZEPHYROS									
	70, 75, 80, 90 cm	120 cm	140 cm	160 cm	170 cm	180 cm	-A	-H	1.036 €	
		REVFA12080	REVFA14080	REVFA16080	REVFA17080	-				
	70, 75, 80, 90 cm	120 cm	140 cm	160 cm	170 cm	180 cm	-A	-H	814 €	
		REVFB12080	REVFB14080	REVFB16080	REVFB17080	-				

4 ACCESORIOS / ACESSÓRIOS



COLUMNA DE DUCHA

Para datos técnicos y detalles ver pag. 308

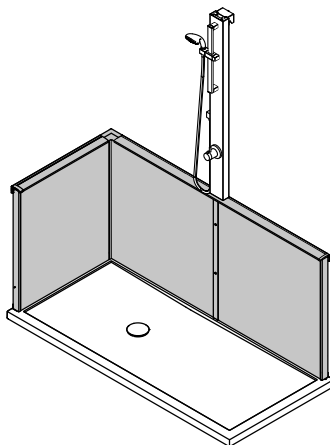

SUJECIÓN A PARED

Attacco a muro	Código	Precio / Preço
Monomando Monocomando	REV2CM-K	636 €
Termostático Termostática	REV2CT-K	725 €

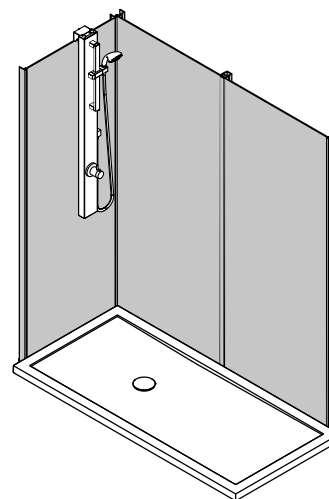

SUJECIÓN SOBRE PANEL

Attacco su pannello	Código	Precio / Preço
Monomando Monocomando	REV2AM-K	636 €
Termostático Termostática	REV2AT-K	725 €



COLUMNA DE DUCHA PLUS CON PORTAOBJETOS

Para datos técnicos y detalles ver pag. 357

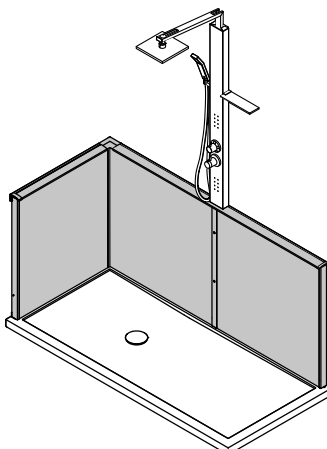

SUJECIÓN A PARED

Attacco a muro	Código	Precio / Preço
Monomando Monocomando	REV2CVM-K	1.007 €
Termostático Termostática	REV2CVT-K	1.096 €

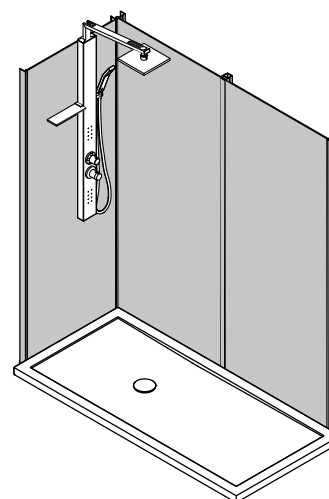

SUJECIÓN SOBRE PANEL

Attacco su pannello	Código	Precio / Preço
Monomando Monocomando	REV2AVM-K	1.007 €
Termostático Termostática	REV2AVT-K	1.096 €

4 ACCESORIOS / ACESSÓRIOS



ESPEJO CON REPISA PORTAOBJETOS

Para instalar a pared o sobre panel H 195 cm

Código	Precio / Preço
REVO01	371 €

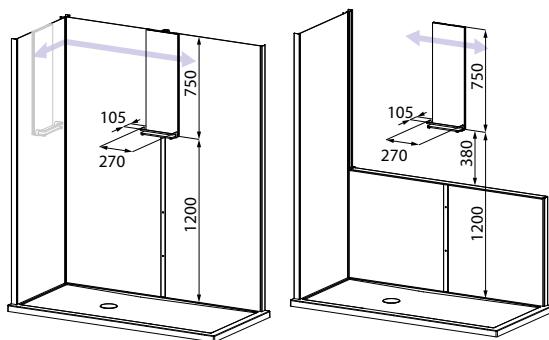

TAPA-PANEL DE TERMINACIÓN

(de 5-25 cm.) de 206,5 cm de altura (recortable a medida)

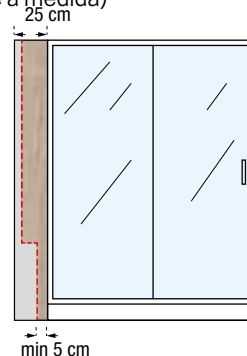

Color Cores	Código	Precio / Preço
Blanco Branco	REVO07A	290 €
Blanco rayado Branco listrado	REVO07I	290 €
Burlington	REVO07N	290 €
Grain	REVO07M	290 €
wengue wengue	REVO07V	290 €



ASIENTO REDONDEADO PLEGABLE ASSENTO REDONDO

REBATIVEL

en material EVA impermeable, antibacterias y atóxico
Peso máximo 150 kg

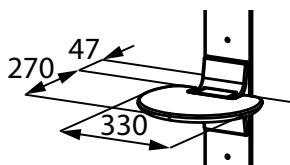

Color Cores	Código	Precio / Preço
Blanco Branco	REVO03-A	578 €
Negro	REVO03-H	578 €



REPOSAPIÉS APOIA-PÉS

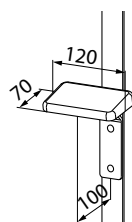

Color Cores	Código	Precio / Preço
Blanco Branco	REVO02-A	135 €
Negro	REVO02-H	135 €



CAJA PARA SUJETAR GRIFERÍA

Completa (flexibles no incluidos)

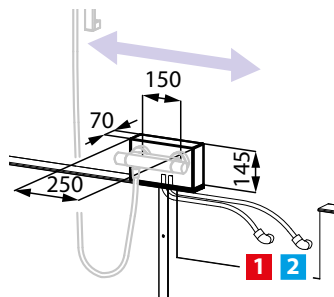

Código	Precio / Preço
REVO04-K	262 €

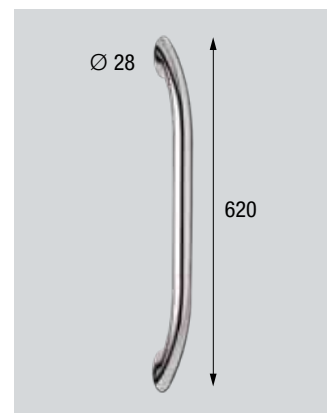

TIRADOR PUXADOR

Código	Precio / Preço
R90MANGL0C-K	262 €

MODELO DE PEDIDO

COMO PERSONALIZAR TU REVOLUTION 2 EN 5 PASOS

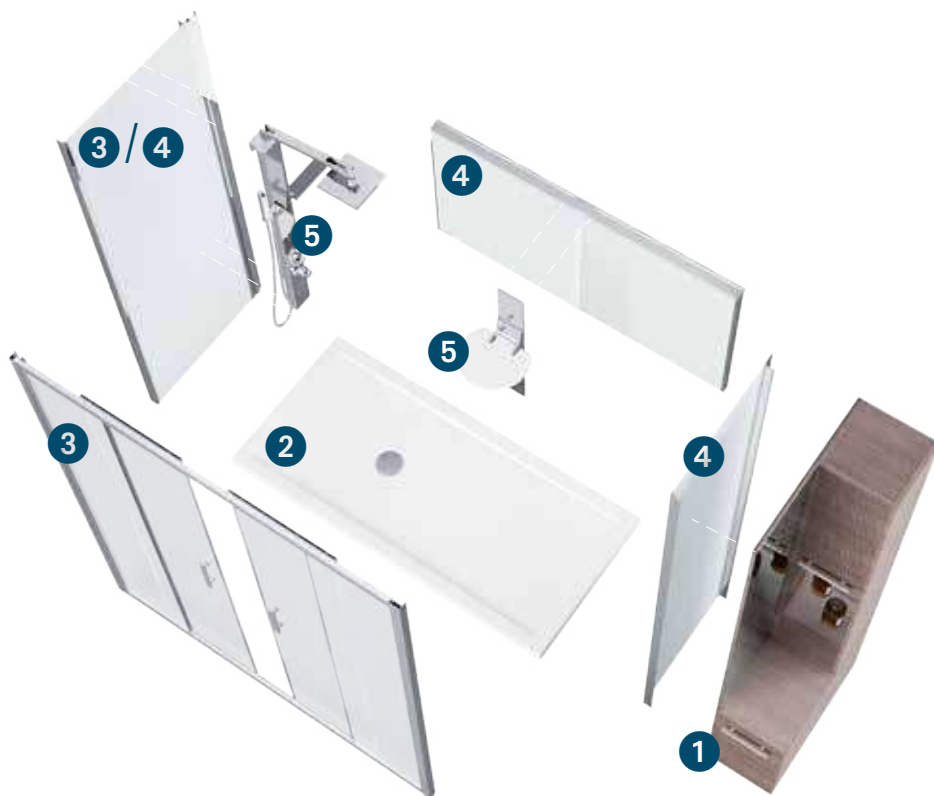

1	COMPLEMENTOS p. 453		COD.
2	PLATOS DE DUCHA BASES DE CHUVEIRO p. 454		COD.
		ZEPHYROS 2P	COD.
3	MAMPARAS DE BAÑO RESGUARDOS DE BANHEIRAS p. 455	ZEPHYROS S	COD.
		ZEPHYROS F	COD.
4	PANELES A PARED PAINÉIS DE PAREDE p. 456		COD.
		COLUMNAS / COLUNAS	COD.
		ASIENTO/ASSENTO	COD.
5	ACCESORIOS ACESSÓRIOS p. 455	ESPEJO/ESPELHO	COD.
		REPOSAPIÉS/APOIA-PÉS	COD.
		AGARRADERO/PEGA	COD.
		CAJA PARA SUJETAR GRIFERÍA CAIXA PARA SEGURAR TORNEIRAS	COD.

REVOLUTION 2 CON COLUMNA MULTIFUNCIÓN

1 COMPLEMENTOS COLUMNA MULTIFUNCIÓN



INSTALACIÓN ANGULAR
INSTALAÇÃO ANGULADA

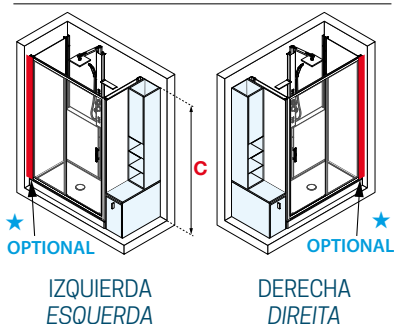

IZQUIERDA
ESQUERDA

DERECHA
DIREITA

INSTALACIÓN A UNA SOLA PARED
INSTALAÇÃO CENTRO DE PAREDE

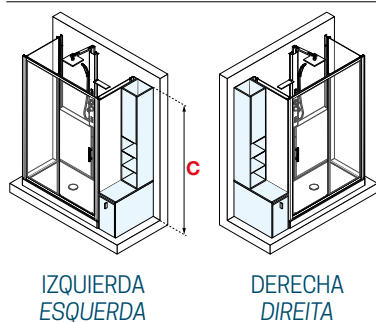

IZQUIERDA
ESQUERDA

DERECHA
DIREITA

- PUERTA CON SOFT CLOSING
- BALDAS INTERNAS EN CRISTAL DE 5 MM
- PORTA REPISAS INCLUIDO

ACABADO LACADO



Blanco brillo
Branco brilho

ACABADO MADERA / ACABAMENTO MADEIRA



Blanco rayado
Branco listrado



Burlington



Grain



wengue
wengue

	Medidas			Código	Selección de color Seleção de Cores de acabados					Precio / Preço
	ancho	altura	Profundidad		A	I	N	M	V	
					Blanco brillo Branco brilho	Blanco rayado Branco listrado	Burlington	Grain	wengue wengue	
versión izquierda versão esquerda	32	207,5	70	REVC08						1.330 €
	32	207,5	75	REVC09						1.391 €
	32	207,5	80	REVC10						1.449 €
versión derecha versão direita	32	207,5	70	REVC05						1.064 €
	32	207,5	75	REVC06						1.391 €
	32	207,5	80	REVC07						1.449 €

★ OPCIONAL PANEL DE TERMINACIÓN (5-25 cm) recortable a medida (solo para instalaciones en ángulo)

	A	I	N	M	V	
Max 25- h 206,5						REVC06
						255 €

REVOLUTION

REVOLUTION 2 CON COLUMNA MULTIFUNCIÓN

2 PLATOS DE DUCHA/BASES DE CHUVEIRO - OLYMPIC PLUS

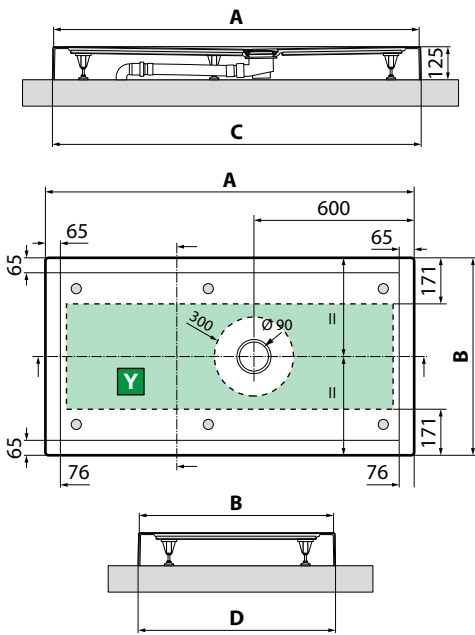

BORDE / REBORDO 12,5 CM

con antideslizante
com antiderrapante

Medidas	Código	Selección de color / precio Seleção de Cores de acabados / Preço						Código	30
		30	79	11	27	29	28		
		Blanco Branco	Blanco mate Branco mate	Beige	Corda	Gris	Negro mate		Blanco Branco
120 x 70	1194 x 692 1200 x 698	OL1207011-	294 €	469 €	496 €	496 €	496 €	OL1207011A-	434 €
120 x 80	1194 x 792 1200 x 798	OL8012011-	300 €	475 €	506 €	506 €	506 €	OL8012011A-	440 €
140 x 70	1392 x 692 1398 x 698	OL1407011-	315 €	491 €	519 €	519 €	519 €	OL1407011A-	455 €
140 x 75	1392 x 742 1398 x 748	OL1407511-	315 €	491 €	519 €	519 €	519 €	OL1407511A-	455 €
140 x 80	1392 x 792 1398 x 798	OL1408011-	341 €	516 €	546 €	546 €	546 €	OL1408011A-	481 €

* Medidas de la parte superior del plato
** Medidas del plato sobre el pavimento

Y Área disponible de desagüe por encima del pavimento

3 MAMPARAS DE BAÑO / RESGUARDOS DE BANHEIRAS

Datos técnicos para la instalación ver pág. 460

PUERTA / PORTA

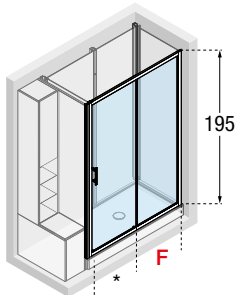

ZEPHYROS 2P para instalar entre paredes, con fijo lateral o a una pared

Medidas	Código	Selección Cristales Seleção Vidros				Selección de perfiles / PrecioSeleção de perfis / Preço						
		1	68	11	54	A	B	K	H			
Extensibilidad	extensibilidad / extensibilidade	Fijo frontal Fixo frontal	Entrada		Transparente	Serigrafía Zephyros 1	Niva	Fumé gris	Blanco Branco	Silver Abrrillantado	Cromo	Negro mate
		F	*									
120	116↔122	55	47	ZEPHYR2P116-		+ 38 €	+ 38 €	+ 100 €	785 €	870 €	958 €	958 €

Reversible
Reversêvel

PARA INSTALAR A UNA PARED

Datos técnicos para la instalación ver pág. 460

1 PANEL FIJO

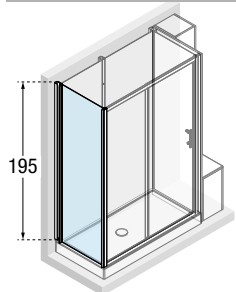

ZEPHYROS F

Medidas	Código	Selección Cristales Seleção Vidros				Selección de perfiles / PrecioSeleção de perfis / Preço							
		1	68	11	54	A	B	K	H				
Extensibilidad	extensibilidad / extensibilidade												
						Transparente	Serigrafía Zephyros 1	Niva	Fumé gris	Blanco Branco	Silver Abrrillantado	Cromo	Negro mate
70	68↔71	ZEPHYRF68-								343 €	373 €	402 €	402 €
75	73↔76	ZEPHYRF73-	+ 40 €	+ 40 €	+ 106 €					343 €	373 €	402 €	402 €
80	78↔81	ZEPHYRF78-								358 €	386 €	416 €	416 €

Reversible
Reversêvel

REVOLUTION 2 CON COLUMNA MULTIFUNCIÓN

4 PANELES A PARED

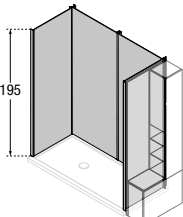
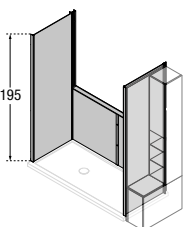
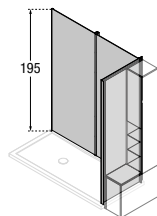
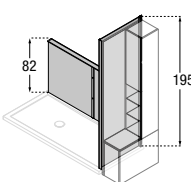
ÁNGULO	Profundidad	extensibilidad / código		Blanco Branco	Negro	Precio / Preço
		120 cm	140 cm			
	70	REVNA12070	REVNA14070	-A	-H	1.625 €
	75	-	REVNA14075			1.625 €
	80	REVNA12080	REVNA14080			1.625 €
	70	REVN12070	REVN14070			1.478 €
	75	-	REVN14075			1.478 €
	80	REVN12080	REVN14080			1.478 €
PARED CENTRAL SÓLO ZEPHYROS						
	70	REVA12070	REVA14070	-A	-H	1.256 €
	75	-	REVA14075			1.256 €
	80	REVA12080	REVA14080			1.256 €
	70	REVAB12070	REVAB14070			1.110 €
	75	-	REVAB14075			1.110 €
	80	REVAB12080	REVAB14080			1.110 €

5 ACCESORIOS / ACESSÓRIOS



COLUMNA DE DUCHA

SUJECIÓN A PARED

Monomando
Monocomando
REV2CM-K 636 €
Termostático
Termostática
REV2CT-K 725 €

SUJECIÓN SOBRE PANEL

Monomando
Monocomando
REV2AM-K 636 €
Termostático
Termostática
REV2AT-K 725 €



COLUMNA DE DUCHA PLUS CON PORTAOBJETOS

SUJECIÓN A PARED

Monomando
Monocomando
REV2CVM-K 1.007 €
Termostático
Termostática
REV2CVT-K 1.096 €

SUJECIÓN SOBRE PANEL

Monomando
Monocomando
REV2AVM-K 1.007 €
Termostático
Termostática
REV2AVT-K 1.096 €



ESPEJO CON REPISA PORTAOBJETOS

REVO01
371 €



ASIENTO REDONDEADO PLEGABLE

ASSENTO REDONDO REBATIVEL
Blanco/Branco
REVO03-A 578 €
Negro
REVO03-H 578 €



CAJA PARA SUJETAR GRIFERÍA

REVO04-K
262 €



APOYAPIÉS APOIA-PÉS

Blanco/Branco
REVO02-A 135 €
Negro
REVO02-H 135 €



TIRADOR PUXADOR

Cromo
R90MANGLOC-K
262 €

REVOLUTION 2 CON AMARIO PARA LAVADORA

1 COMPLEMENTOS ARMARIO PARA LAVADORA CON CAJONERA INFERIOR

IZQUIERDA / ESQUERDA

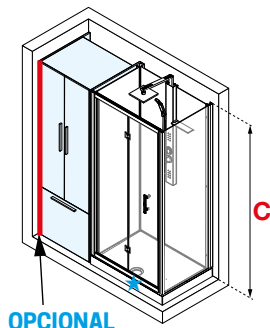

OPCIONAL

DERECHA / DIREITA

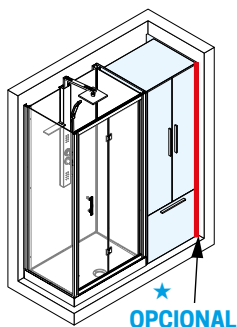

OPCIONAL

- PUERTA CON SOFT CLOSING
- HABILITADA PARA LA SALIDA DE DESAGUE DE LA LAVADORE



ACABADO LACADO



Blanco brillo
Branco brilho

ACABADO MADERA



Blanco rayado
Branco listrado



Burlington



Grain



wengue
wengue

Medidas			Código	Selección de color Seleção de Cores de acabados					Precio / Preço
ancho	altura	Profundidad		A	I	N	M	V	
				Blanco brillo Branco brilho	Blanco rayado Branco listrado	Burlington	Grain	wengue wengue	

C

VERSIÓN PARA MAMPARA

72	206,5	70	REVC01						1.625 €
72	206,5	80	REVC02						1.700 €

VERSIÓN SOLO MUEBLE

72	206,5	70	REVCS1						2.113 €
72	206,5	80	REVCS2						2.202 €

Datos técnicos para la instalación ver pag. 461

★ OPCIONAL PANEL DE TERMINACIÓN (5-25 cm) recortable a medida (solo para instalaciones en ángulo)

			A	I	N	M	V		
	Max 25- h 206,5	REVO06							255 €

OPCIONAL

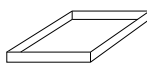

HABITÁCULO PORTA DETERGENTE

200 x 460 x H 30

Código	Precio / Preço
REVB11A	142 €

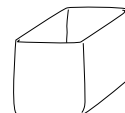

PUERTA CESTA COLADA

360 x 460 x H 360

Código	Precio / Preço
REVB11B	262 €

VERSIÓN SOLO MUEBLE

REVOLUTION 2 CON ARMARIO LAVADORA + SECADORA

1 COMPLEMENTOS ARMARIO PARA LAVADORA Y SECADORA

IZQUIERDA / ESQUERDA

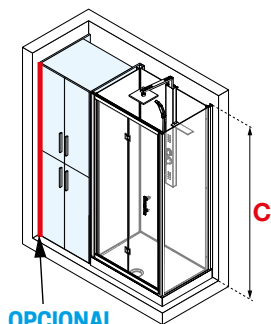

OPCIONAL

DERECHA / DIREITA

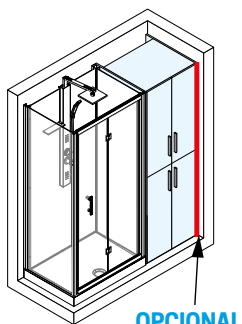

OPCIONAL

- PUERTA CON SOFT CLOSING
- HABILITADA PARA LA SALIDA DE DESAGUE DE LA LAVADORE



ACABADO LACADO



Blanco brillo
Branco brilho

ACABADO MADERA



Blanco rayado
Branco listrado



Burlington



Grain



wengue
wengue

Medidas			Código	Selección de color Seleção de Cores de acabados					Precio / Preço
ancho	altura	Profundidad		A	I	N	M	V	
	C			Blanco brillo Branco brilho	Blanco rayado Branco listrado	Burlington	Grain	wengue wengue	

VERSIÓN PARA MAMPARA

72	206,5	70	REVC03						1.394 €
72	206,5	80	REVC04						1.465 €

VERSIÓN SOLO MUEBLE

72	206,5	70	REVCS3						1.938 €
72	206,5	80	REVCS4						2.022 €

Datos técnicos para la intalación ver pag. 461

★ OPCIONAL PANEL DE TERMINACIÓN (5-25 cm) recortable a medida (solo para instalaciones en ángulo)

			A	I	N	M	V	
	Max 25- h 206,5	REV006						255 €



VERSIÓN SOLO MUEBLE

REVOLUTION 2 CON ARMARIO LAVADORA

2 PLATOS DE DUCHA/BASES DE CHUVEIRO - OLYMPIC

BORDE / REBORDO 11,5 CM

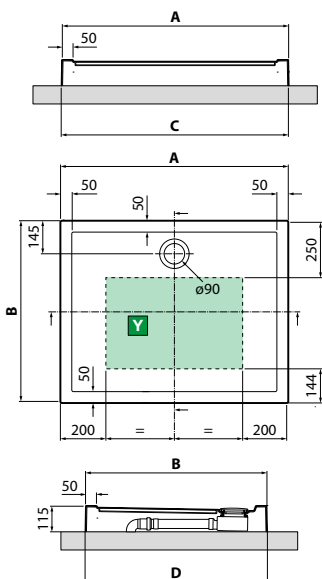

Medidas			Código	Selección de color / precio Seleção de Cores de acabados / Preço					
	AxB* ± 2 mm	CxD** ± 3 mm		30	79	11	27	29	28
90 x 70	894 x 694	898 x 698	OLN907011-	Blanco Branco	blanco mate Branco mate	beige	Corda	Gris	Negro mate
100 x 70	994 x 694	998 x 698	OLN1007011-	239 €	408 €	431 €	431 €	431 €	431 €
100 x 80	994 x 794	998 x 798	OLN1008011-	265 €	437 €	459 €	459 €	459 €	459 €
120 x 80	1194 x 794	1198 x 798	OLN1208011-	272 €	443 €	465 €	465 €	465 €	465 €
				279 €	448 €	472 €	472 €	472 €	472 €

* Medidas de la parte superior del plato
** Medidas del plato sobre el pavimento

Y Área disponible de desagüe por encim del pavimento

OPCIONAL

VÁLVULA DE DESAGÜE
Ø 90

Código	Precio / Preço
PIL90PCAB-CR40	39 €

3 MAMPARAS DE BAÑO / RESGUARDOS DE BANHEIRAS

Datos técnicos para la instalación ver pág. 460

PUERTA / PORTA

ZAFIRO S REVERSIBLE / REVERSÊVEL

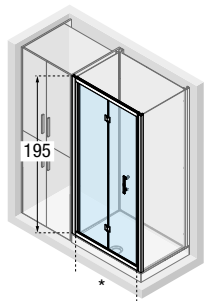

Medidas				Código	Selección Cristales Seleção Vidros				Selección de perfiles / PrecioSeleção de prefis / Preço			
Extensibi- lidad	extensibilidad / extensibilidade	Fijo frontal Fixo frontal	Entrada		1	68	11	54	A	B	K	H
		B	*		Transpa- rente	Serigrafia Zephyros 1	Niva	Fumé gris	Blanco Branco	Silver Abrillantado	Cromo	Negro mate
90	86↔92	41	67	ZEPHYRS86-					752 €	829 €	907 €	907 €
100	96↔102	46	77	ZEPHYRS96-	+ 38 €	+ 38 €	+ 100 €		782 €	858 €	935 €	935 €

ZAFIRO 2P REVERSIBLE / REVERSÊVEL

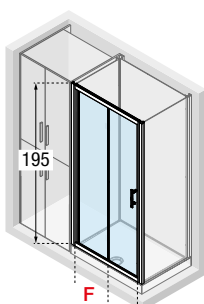

Medidas				Código	Selección Cristales Seleção Vidros				Selección de perfiles / PrecioSeleção de prefis / Preço			
Extensibilidad	extensibilidad / extensibilidade	Fijo frontal Fixo frontal	Entrada		1	68	11	54	A	B	K	H
		F	*		Transpa- rente	Serigrafia Zephyros 1	Niva	Fumé gris	Blanco Branco	Silver Abrillantado	Cromo	Negro mate
120	116↔122	55	47	ZEPHYR2P116-		+ 38 €	+ 38 €	+ 100 €	785 €	870 €	958 €	958 €

1 PANEL FIJO

ZAFIRO F REVERSIBLE / REVERSÊVEL

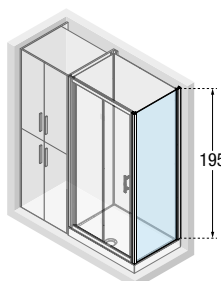

Medidas			Código	Selección Cristales Seleção Vidros				Selección de perfiles / PrecioSeleção de prefis / Preço			
Extensibilidad	extensibilidad / extensibilidade			1	68	11	54	A	B	K	H
				Transpa- rente	Serigrafia Zephyros 1	Niva	Fumé gris	Blanco Branco	Silver Abrillantado	Cromo	Negro mate
70	68↔71	ZEPHYRF68-						343 €	373 €	402 €	402 €
80	78↔81	ZEPHYRF78-		+ 40 €	+ 40 €	+ 106 €		358 €	386 €	416 €	416 €

REVOLUTION 2 CON ARMARIO LAVADORA

4 PANELES A PARED

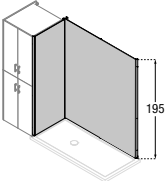
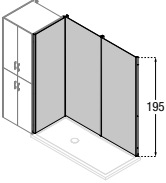
	Profundidad	extensibilidad / código			Blanco Branco	Negro	Precio / Preço
		90 cm	100 cm	120 cm	-A	-H	
	70	REVAA9070	REVAA10070	-			1.256 €
	80	-	REVAA10080	-			1.256 €
	80	-	-	REVAA12080			1.256 €

5 ACCESORIOS / ACESSÓRIOS



COLUMNA DE DUCHA

SUJECIÓN A PARED

Monomando
Monocomando
REV2CM-K 636 €
Termostático
Termostática
REV2CT-K 725 €

SUJECIÓN SOBRE PANEL

Monomando
Monocomando
REV2AM-K 636 €
Termostático
Termostática
REV2AT-K 725 €



COLUMNA DE DUCHA PLUS CON PORTAOBJETOS

SUJECIÓN A PARED

Monomando
Monocomando
REV2CVM-K 1.007 €
Termostático
Termostática
REV2CVT-K 1.096 €

SUJECIÓN SOBRE PANEL

Monomando
Monocomando
REV2AVM-K 1.007 €
Termostático
Termostática
REV2AVT-K 1.096 €



ESPEJO CON REPISA PORTAOBJETOS

REVO01
371 €



ASIENTO REDONDEADO PLEGABLE

ASSENTO REDONDO REBATIVEL
Blanco/Branco
REVO03-A 578 €
Negro
REVO03-H 578 €



CAJA PARA SUJETAR GRIFERÍA

REVO04-K
262 €



APOYAPIÉS APOIA-PÉS

Blanco/Branco
REVO02-A 135 €
Negro
REVO02-H 135 €



TIRADOR PUXADOR

Cromo
R90MANGL0C-K
262 €

OPCIONAL

TAPA-PANEL DE TERMINACIÓN (de 5-25 cm.) de 206,5 cm de altura (recortable a medida)

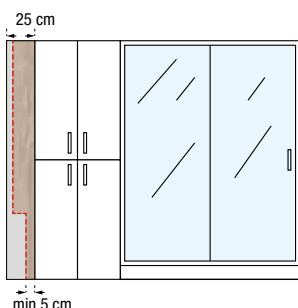

Color Cores	Código	Precio / Preço
Blanco Branco	REVO06A	290 €
Blanco rayado Branco listrado	REVO06I	290 €
Burlington	REVO06N	290 €
Grain	REVO06M	290 €
wengue wengue	REVO06V	290 €

La tapa-panel de terminación se puede recortar y permite la instalación de la Revolution incluso en situaciones especiales en las entregas a pared.

La medida mínima de la tapa es de 5 cm. después del recorte.

INSTALACIÓN ENTRE PAREDES SÓLO CON ZAFIRO

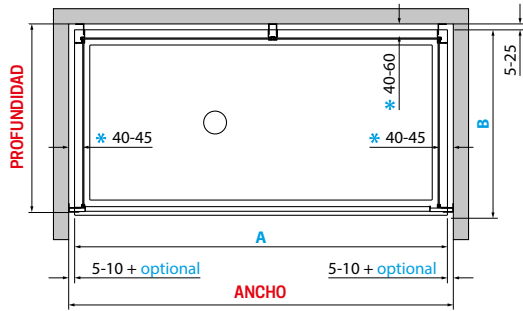

plato	ANCHO DE LA MAMPARA				
A	extensibilidad STANDARD	opcional			
		para Zephyros	para Giada	TAPA-PANEL DE TERMINACIÓN (de 5-25 cm.) de 206,5 cm de altura (recortable a medida)	
120	1205-1220	max 1245	max 1260	max 1275	max 1470
140	1405-1420	max 1445	max 1460	max 1475	max 1670
160	1605-1620	max 1645	max 1660	max 1675	max 1870
170	1705-1720	max 1745	max 1760	max 1775	max 1970
180	1805-1820	max 1845	max 1860	max 1875	max 2070

plato	PROFUNDIDAD DE LA MAMPARA		
B	extensibilidad STANDARD		
		70	685-705
		75	735-755
		80	785-805
		90	885-905

INSTALACIÓN A UNA SOLA PARED SÓLO CON ZAFIRO

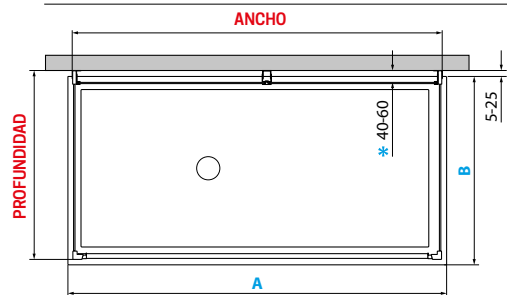

plato	ANCHO DE LA MAMPARA	
A	120	1175
	140	1375
	160	1575
	170	1675
	180	1775

plato	PROFUNDIDAD DE LA MAMPARA	
B	70	685-705
	75	735-755
	80	785-805

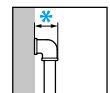

ATENCIÓN!
Espacio necesario para conexión hidráulica

INSTALACIÓN EN ÁNGULO CON ZAFIRO Y GIADA

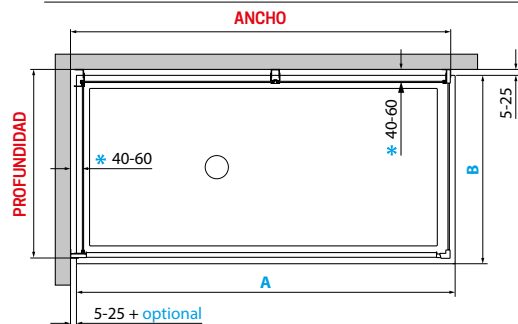

plato	ANCHO DE LA MAMPARA		
A	extensibilidad STANDARD	opcional no posible con paneles todos bajos	
		para Zephyros	para Giada
120	1190-1210	max 1225	max 1460
140	1390-1410	max 1425	max 1660
160	1590-1610	max 1625	max 1860
170	1690-1710	max 1725	max 1960
180	1790-1810	max 1825	max 2060

plato	PROFUNDIDAD DE LA MAMPARA		
B	extensibilidad STANDARD		
		70	685-705
		75	735-755
		80	785-805
		90	885-905

INSTALACIÓN EN ÁNGULO PARA LAVADORA Y SECADORA

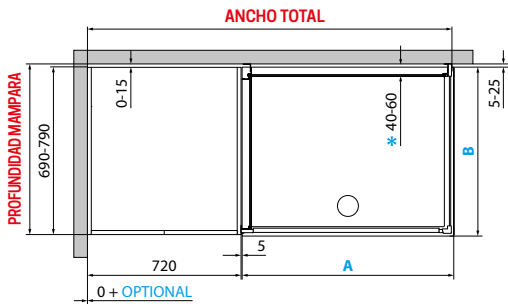

plato	ANCHO TOTAL			
A	STANDARD	opcional (50-250 mm) PANEL DE TERMINACIÓN RECORTABLE A MEDIDA		
		90	1610	max 1860
		100	1710	max 1960
120	1910	max 2160		

plato	PROFUNDIDAD DE LA MAMPARA	
B	70	690-705
	80	790-805

INSTALACIÓN EN ÁNGULO PARA COLUMNA MULTIFUNCIÓN

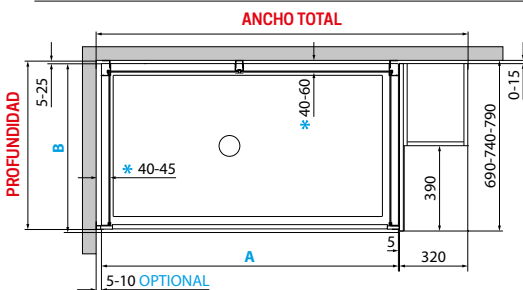

plato	ANCHO TOTAL			
A	STANDARD	opcional (50-250 mm) PANEL DE TERMINACIÓN RECORTABLE A MEDIDA		
		120	1525-1530	max 1780
		140	1725-1730	max 1980

plato	PROFUNDIDAD DE LA MAMPARA	
B	70	685-705
	75	735-755
	80	785-805

INSTALACIÓN A UNA SOLA PARED PARA COLUMNA MULTIFUNCIÓN

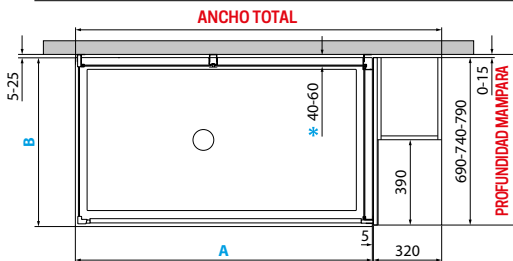

plato	ANCHO TOTAL	
A	120	1510
	140	1710

plato	PROFUNDIDAD DE LA MAMPARA	
B	70	690-705
	75	740-755
	80	790-805

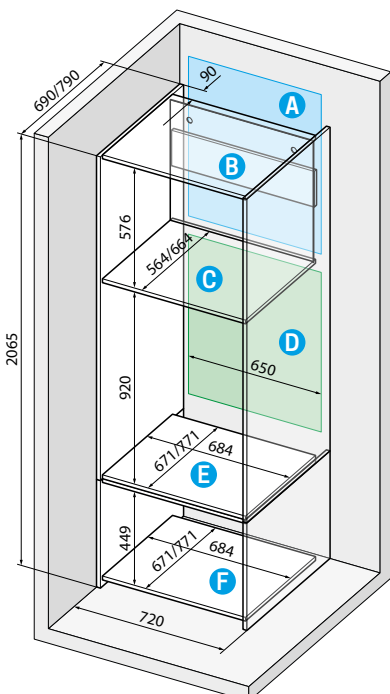

ARMARIO PARA LAVADORA CON CAJONERA INFERIOR

- A** Zona para la conexión eléctrica
- B** Hueco con pared desmontable
- C** Estante para la colada
- D** Hueco sin pared posterior para el desagüe y conexión hidráulica
- E** Estante de apoyo para lavadora
- F** Estante con cajón extraíble

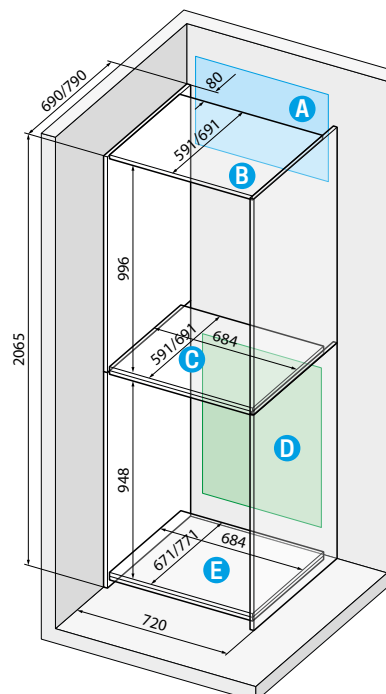

ARMARIO PARA LAVADORA Y SECADORA

- A** Zona para la conexión eléctrica
- B** Hueco sin pared posterior
- C** Estante de apoyo para secadora
- D** Hueco sin pared posterior para el desagüe y conexión hidráulica
- E** Estante de apoyo para lavadora

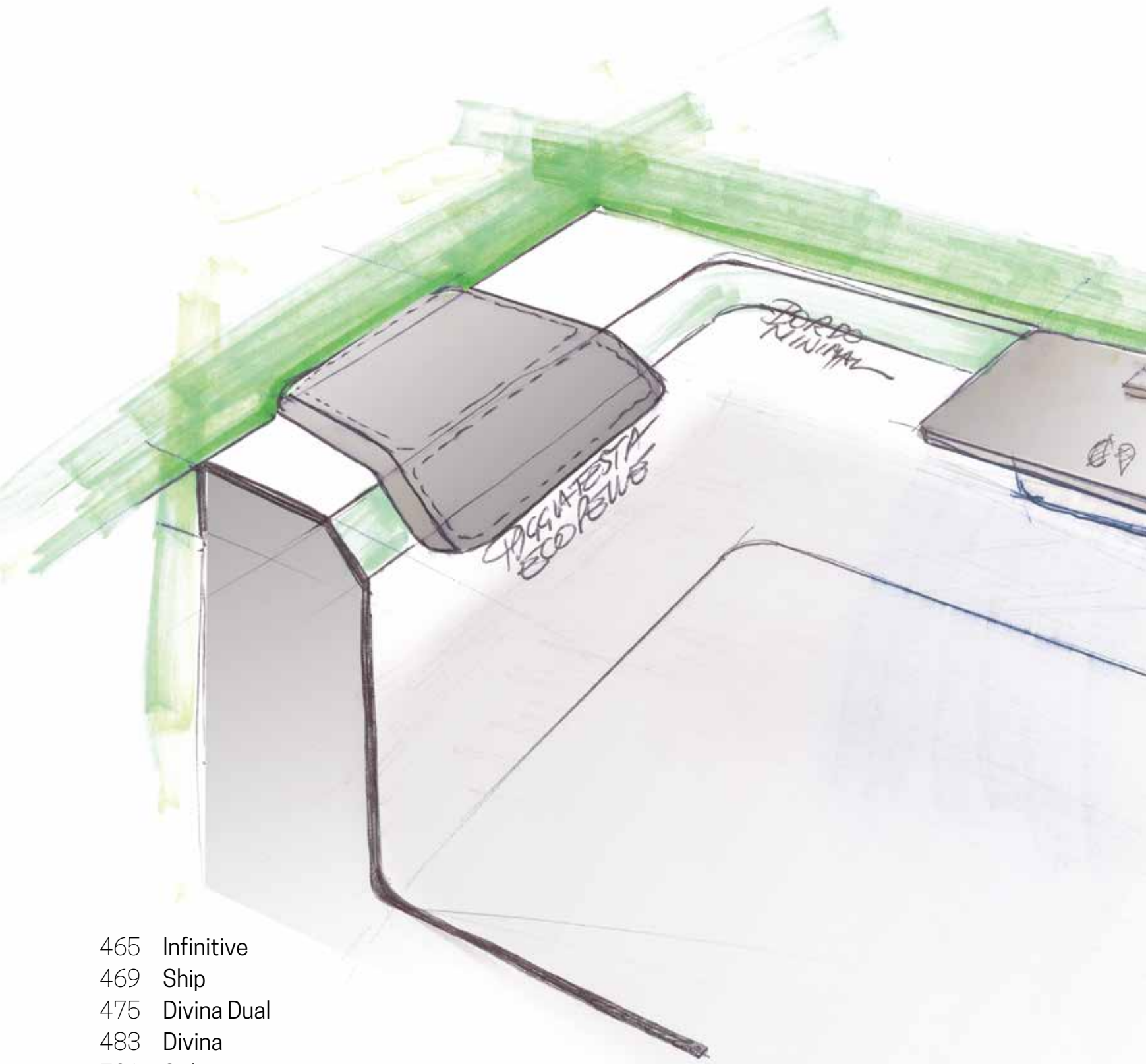

- 465 Infinitive
- 469 Ship
- 475 Divina Dual
- 483 Divina
- 501 Stile
- 511 Sense Dual
- 515 Sense 2.0
- 523 Calos
- 527 Iris
- 531 Calypso
- 533 Vogue
- 534 Baby

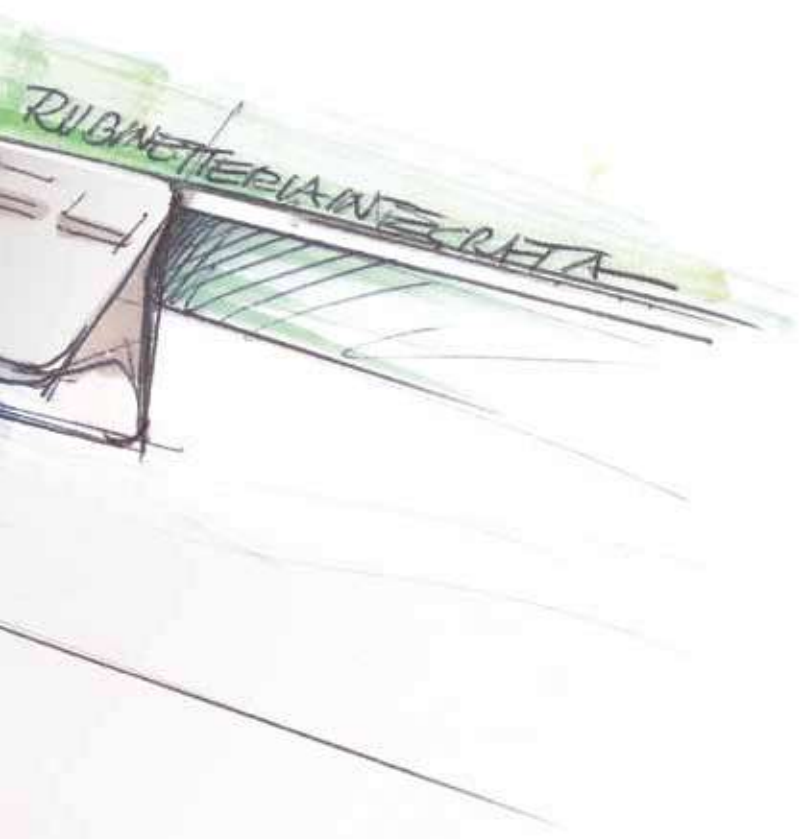

BAÑERAS BANHEIRAS

EL MEJOR TIEMPO
QUE PUEDES
REGALARTE.

O MELHOR
MOMENTO QUE
VOCÊ PODE DAR
A SI MESMO.

Imagina una experiencia personal a 360º, capaz de estimular el cuerpo y revitalizar el espíritu. Con las bañeras Novellini ponemos a tu disposición la posibilidad de tener el puro relax personal dentro de un espacio diseñado para ti. Regula la intensidad del hidromasaje con sus programas específicos y entrégate a un momento inolvidable. La propuesta de sistemas de bienestar de las bañeras Novellini - funciones, equipamiento, acabados y opciones - es realmente amplia y se adapta a cualquier necesidad.

Imagine uma experiência pessoal de 360º, capaz de estimular o corpo e revitalizar o espírito. Com as banheiras Novellini, colocamos à sua disposição a possibilidade de ter relaxamento pessoal puro dentro de um espaço projetado pessoalmente. Regula a intensidade da hidromassagem com programas específicos e entrega-se a um momento inesquecível. Os sistemas de bem-estar das banheiras Novellini - funções, equipamentos, acabamentos e opções - são realmente amplos e podem ser adaptados a qualquer necessidade.



BAÑERA COLOR MOSTAZA CON MUEBLE A CENTRO DE PARED Y LUZ LED EXTERIOR.



BAÑERA EXENTA COLOR RUBÍ CON LUZ LED EXTERIOR

NOVOTECH: VANGUARDIA, CREATIVIDAD Y RESISTENCIA VANGUARDA, CRIATIVIDADE E RESISTÊNCIA

Novotech la superficie sólida de nueva generación. Homogénea en todo su espesor, agradable al tacto y capaz de crear un impacto visual completamente nuevo, en perfecta armonía con el diseño esencial de Novellini. La síntesis de la excelencia.

Novotech a nova geração de superfície sólida. Homogénea em toda a sua espessura, agradável ao toque e capaz de criar um impacto visual completamente novo, em perfeita harmonia com o design essencial da Novellini. A síntese da excelência.

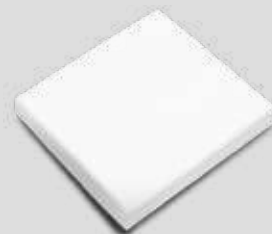

INFINITIVE | ACABADOS

Ponga color en su cuarto de baño, ¡personalice su estilo! Novellini le ofrece una selección de 64 colores lacados mate entre los que dar rienda suelta a su imaginación.

Traga cor para a sua casa de banho, personalize o seu estilo! Novellini oferece-lhe uma escolha de 64 cores de verniz mate, de onde libertar a sua imaginação.

◆ ELECCIÓN COLOR - TODOS LOS COLORES DISPONIBLES EN LA PÁGINA. 473

INFINITIVE | EQUIPAMIENTO Y FUNCIONES (disponibles según versión)

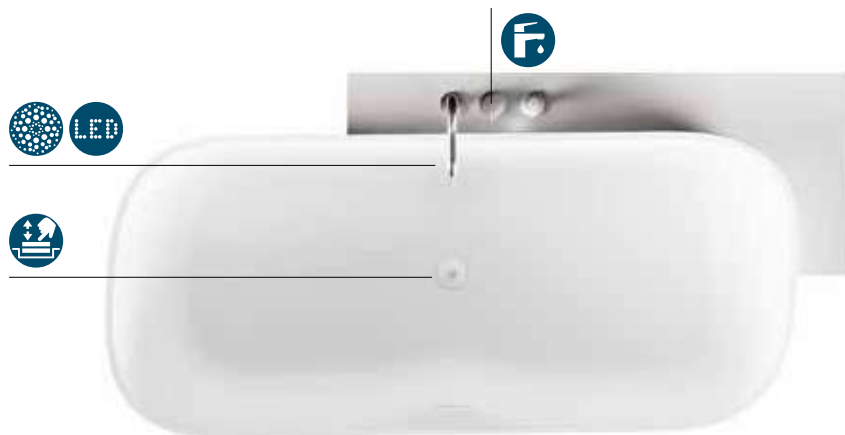

Natural air



Iluminación interna LED
Iluminação interna LED



Grifería al borde de la bañera
Torneira no rebordo da banheira



Válvula click-clack

BAÑERA DOTADA CON REBOSADERO INTEGRADO CONFORME A LA NORMATIVA EN VIGOR



Designed by Simone Micheli



BAÑERA COLOR BLANCO MATE CON LUZ LED EXTERIOR



Mueble para bañera: tecnología y estética



Tu baño, tu color, tu personalidad



Déjate envolver por las microburbujas que acarician silenciosamente el cuerpo y ayudan a la oxigenación de la piel. El placer de un masaje, inmerso en un deseo armonioso.



Luz LED exterior perimetral

INFINITIVE



INFINITIVE

INFINITIVE

**BAÑERA EN NOVOTECH COLOR INTERIOR BLANCO MATE Y EXTERIOR A ELEGIR.
MUEBLE OPCIONAL CON BASE EN NOVOTECH BLANCO MATE + COLOR A ELEGIR**

Medidas			Elección instalación mueble	Código	Elección acabado exterior bañera		Elección acabado mueble					
Cm	H	Lt.			Blanco mate	Elección color	Blanco mate	Blanco rayado	Grain	Burlington	wengue	Elección color
					Blanco mate	Blanco mate	Blanco rayado	Acabados madera				Elección color
					Blanco mate	Blanco mate	Blanco rayado	Grain	Burlington	wengue	Elección color	
STANDARD												
170 x 75	70	360	-	INF1170750-	4.558 €	+ 827 €						
VERSIÓN STANDARD CON MUEBLE												
170 x 75	70	360	Freestanding	INF1170750CS-	5.525 €	+ 827 €		+ 80 €	+ 80 €	+ 80 €	+ 80 €	+ 180 €
170 x 75	70	360	Centro de pared	INF1170750CP-								
170 x 75	70	360	Esquina ángulo DX	INF1170750AD-	5.674 €			+ 146 €	+ 146 €	+ 146 €	+ 146 €	
170 x 75	70	360	Esquina ángulo SX	INF1170750AS-								
VERSIÓN STANDARD CON MUEBLE Y GRIFERÍA A BORDE DE BAÑERA												
170 x 75	70	360	Freestanding	INF1170752CS-	5.949 €	+ 827 €		+ 80 €	+ 80 €	+ 80 €	+ 80 €	+ 180 €
170 x 75	70	360	Centro de pared	INF1170752CP-								
170 x 75	70	360	Esquina ángulo DX	INF1170752AD-	6.098 €			+ 146 €	+ 146 €	+ 146 €	+ 146 €	
170 x 75	70	360	Esquina ángulo SX	INF1170752AS-								
VERSIÓN NATURAL AIR CON MUEBLE												
170 x 75	70	360	Freestanding	INFN1707500CS-	9.167 €	+ 827 €		+ 80 €	+ 80 €	+ 80 €	+ 80 €	+ 180 €
170 x 75	70	360	Centro de pared	INFN1707500CP-								
170 x 75	70	360	Esquina ángulo DX	INFN1707500AD-	9.787 €			+ 146 €	+ 146 €	+ 146 €	+ 146 €	
170 x 75	70	360	Esquina ángulo SX	INFN1707500AS-								
VERSIÓN NATURAL AIR CON MUEBLE Y GRIFERÍA A BORDE DE BAÑERA												
170 x 75	70	360	Freestanding	INFN1707502CS-	9.591 €	+ 827 €		+ 80 €	+ 80 €	+ 80 €	+ 80 €	+ 180 €
170 x 75	70	360	Centro de pared	INFN1707502CP-								
170 x 75	70	360	Esquina ángulo DX	INFN1707502AD-	10.211 €			+ 146 €	+ 146 €	+ 146 €	+ 146 €	
170 x 75	70	360	Esquina ángulo SX	INFN1707502AS-								

OPCIONAL: LUZ LED EXTERIOR, VER PÁGINA XXX



GRIFERÍA COLOR NEGRO MATE BAJO PEDIDO: + 159 €



◆ ELECCIÓN COLOR - TODOS LOS COLORES DISPONIBLES EN LA PÁGINA. 473





MOBILIARIO PARA LA BAÑERA: TECNOLOGÍA Y ESTÉTICA

El tipo de mueble propuesto es el complemento ideal para añadir funciones a la bañera sin renunciar a su personalidad estética. Dotada de una grifería de alto diseño, permite alojar la tecnología necesaria. Se puede pedir en el mismo color de la bañera.

NATURAL AIR: SILENCIO, PLACER Y FELICIDAD

La tecnología Natural Air, 100 % made in Italy, certificada por Novellini, transformará tu baño en una experiencia de silencioso relax y de regeneración psico-física absolutamente increíble.

EXENTA



EXENTA / CENTRO DE PARED CON MUEBLE CENTRADO Y GRIFERÍA



ÁNGULO IZQUIERDO CON MUEBLE Y GRIFERÍA



ÁNGULO DERECHO CON MUEBLE Y GRIFERÍA





BAÑERA EXENTA COLOR TIERRA CON LUZ LED EXTERIOR



BAÑERA EXENTA COLOR BLANCO CON LUZ LED EXTERIOR

NOVOTECH: VANGUARDIA, CREATIVIDAD Y RESISTENCIA VANGUARDA, CRIATIVIDADE E RESISTÊNCIA

Novotech la superficie sólida de nueva generación. Homogénea en todo su espesor, agradable al tacto y capaz de crear un impacto visual completamente nuevo, en perfecta armonía con el diseño esencial de Novellini. La síntesis de la excelencia.

Novotech a nova geração de superfície sólida. Homogénea em toda a sua espessura, agradável ao toque e capaz de criar um impacto visual completamente novo, em perfeita harmonia com o design essencial da Novellini. A síntese da excelência.

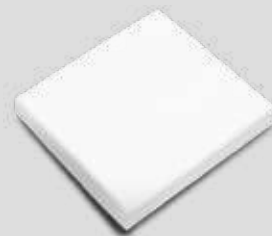

INFINITIVE | ACABADOS

Ponga color en su cuarto de baño, ¡personalice su estilo! Novellini le ofrece una selección de 64 colores lacados mate entre los que dar rienda suelta a su imaginación.

Traga cor para a sua casa de banho, personalize o seu estilo! Novellini oferece-lhe uma escolha de 64 cores de verniz mate, de onde libertar a sua imaginação.

◆ ELECCIÓN COLOR - TODOS LOS COLORES DISPONIBLES EN LA PÁGINA. 473

SHIP | EQUIPAMIENTO Y FUNCIONES (disponibles según versión)



Natural air

Iluminación interna LED
Iluminação interna LED

Grifería al borde de la bañera
Torneira no rebordo da banheira

Válvula click-clack

BAÑERA DOTADA CON REBOSADERO INTEGRADO CONFORME A LA NORMATIVA EN VIGOR



Designed by Simone Micheli



BAÑERA COLOR MOSTAZA CON LUZ LED EXTERIOR



Mueble para bañera: tecnología y estética



Tu baño, tu color, tu personalidad



Déjate envolver por las microburbujas que acarician silenciosamente el cuerpo y ayudan a la oxigenación de la piel. El placer de un masaje, inmerso en un deseo armonioso.



Luz LED exterior perimetral

SHIP



SHIP

SHIP

**BAÑERA EN NOVOTECH COLOR INTERIOR BLANCO MATE Y EXTERIOR A ELEGIR.
MUEBLE OPCIONAL CON BASE EN OCRITECH + COLOR ELEGIR**

Medidas			Elección instalación mueble	Código	Elección acabado exterior bañera		Elección acabado mueble								
Cm	H	Lt.			Blanco mate Branco mate	Elección color	Acabados madera								
					Blanco rayado Branco listrado	Grain	Burlington	wengue wengue	Elección color						
STANDARD															
					U	◆	U	I	M	N	V	◆			
150 x 70	62	265	-	SHI115070-	3.710 €										
160 x 70	62	280	-	SHI116070-	4.134 €	+ 827 €									
VERSIÓN STANDARD CON MUEBLE															
					U	◆	U	I	M	N	V	◆			
150 x 70	62	265	Freestanding	SHI1150700CS-	4.682 €			+ 80 €	+ 80 €	+ 80 €	+ 80 €				
150 x 70	62	265	Centro de pared	SHI1150700CP-											
150 x 70	62	265	Esquina ángulo DX	SHI1150700AD-	4.831 €			+ 146 €	+ 146 €	+ 146 €	+ 146 €				
150 x 70	62	265	Esquina ángulo SX	SHI1150700AS-		+ 827 €						+ 180 €			
160 x 70	62	280	Freestanding	SHI1160700CS-	5.100 €			+ 80 €	+ 80 €	+ 80 €	+ 80 €				
160 x 70	62	280	Centro de pared	SHI1160700CP-											
160 x 70	62	280	Esquina ángulo DX	SHI1160700AD-	5.249 €			+ 146 €	+ 146 €	+ 146 €	+ 146 €				
160 x 70	62	280	Esquina ángulo SX	SHI1160700AS-											
VERSIÓN STANDARD CON MUEBLE Y GRIFERÍA A BORDE DE BAÑERA															
					U	◆	U	I	M	N	V	◆			
150 x 70	62	265	Freestanding	SHI1150702CS-	5.106 €			+ 80 €	+ 80 €	+ 80 €	+ 80 €				
150 x 70	62	265	Centro de pared	SHI1150702CP-											
150 x 70	62	265	Esquina ángulo DX	SHI1150702AD-	5.255 €			+ 146 €	+ 146 €	+ 146 €	+ 146 €				
150 x 70	62	265	Esquina ángulo SX	SHI1150702AS-		+ 827 €						+ 180 €			
160 x 70	62	280	Freestanding	SHI1160702CS-	5.524 €			+ 80 €	+ 80 €	+ 80 €	+ 80 €				
160 x 70	62	280	Centro de pared	SHI1160702CP-											
160 x 70	62	280	Esquina ángulo DX	SHI1160702AD-	5.673 €			+ 146 €	+ 146 €	+ 146 €	+ 146 €				
160 x 70	62	280	Esquina ángulo SX	SHI1160702AS-											
VERSIÓN NATURAL AIR CON MUEBLE															
					U	◆	U	I	M	N	V	◆			
150 x 70	62	265	Freestanding	SHIN1507000CS-	8.343 €			+ 80 €	+ 80 €	+ 80 €	+ 80 €				
150 x 70	62	265	Centro de pared	SHIN1507000CP-											
150 x 70	62	265	Esquina ángulo DX	SHIN1507000AD-	8.967 €			+ 146 €	+ 146 €	+ 146 €	+ 146 €				
150 x 70	62	265	Esquina ángulo SX	SHIN1507000AS-		+ 827 €						+ 180 €			
160 x 70	62	280	Freestanding	SHIN1607000CS-	8.740 €			+ 80 €	+ 80 €	+ 80 €	+ 80 €				
160 x 70	62	280	Centro de pared	SHIN1607000CP-											
160 x 70	62	280	Esquina ángulo DX	SHIN1607000AD-	9.359 €			+ 146 €	+ 146 €	+ 146 €	+ 146 €				
160 x 70	62	280	Esquina ángulo SX	SHIN1607000AS-											
VERSIÓN NATURAL AIR CON MUEBLE Y GRIFERÍA A BORDE DE BAÑERA															
					U	◆	U	I	M	N	V	◆			
150 x 70	62	265	Freestanding	SHIN1507002CS-	8.767 €			+ 80 €	+ 80 €	+ 80 €	+ 80 €				
150 x 70	62	265	Centro de pared	SHIN1507002CP-											
150 x 70	62	265	Esquina ángulo DX	SHIN1507002AD-	9.391 €			+ 146 €	+ 146 €	+ 146 €	+ 146 €				
150 x 70	62	265	Esquina ángulo SX	SHIN1507002AS-		+ 827 €						+ 180 €			
160 x 70	62	280	Freestanding	SHIN1607002CS-	9.164 €			+ 80 €	+ 80 €	+ 80 €	+ 80 €				
160 x 70	62	280	Centro de pared	SHIN1607002CP-											
160 x 70	62	280	Esquina ángulo DX	SHIN1607002AD-	9.783 €			+ 146 €	+ 146 €	+ 146 €	+ 146 €				
160 x 70	62	280	Esquina ángulo SX	SHIN1607002AS-											



◆ ELECCIÓN COLOR - TODOS LOS COLORES DISPONIBLES EN LA PÁGINA. 473



GRIFERÍA COLOR NEGRO MATE BAJO PEDIDO: + 159 €



MOBILIARIO PARA LA BAÑERA: TECNOLOGÍA Y ESTÉTICA

El tipo de mueble propuesto es el complemento ideal para añadir funciones a la bañera sin renunciar a su personalidad estética. Dotada de una grifería de alto diseño, permite alojar la tecnología necesaria. Se puede pedir en el mismo color de la bañera.

NATURAL AIR: SILENCIO, PLACER Y FELICIDAD

La tecnología Natural Air, 100 % made in Italy, certificada por Novellini, transformará tu momento del baño en una experiencia de silencioso relax y de regeneración psico-física absolutamente increíble.

EXENTA



EXENTA / CENTRO DE PARED CON MUEBLE CENTRADO Y GRIFERÍA



ÁNGULO IZQUIERDO CON MUEBLE Y GRIFERÍA



ÁNGULO DERECHO CON MUEBLE Y GRIFERÍA



SHIP



◀
GRIFERÍA EXTERIOR A SUELO

Color / Cores	Código	Precio / Preço
Cromo	RUBPVASRSN-K	1.524 €
Negro mate	RUBPVASRSN-H	1.789 €



◀
KIT LED PERIMETRAL INFERIOR PARA BAÑERA INFINITIVE

Código	Precio / Preço
KLINF	371 €

◀
KIT LED PERIMETRAL INFERIOR PARA BAÑERA SHIP

Medidas (cm)	Código	Precio / Preço
150	KLSHI150	371 €
160	KLSHI160	

COLORES ESPECIALES BAJO PEDIDO

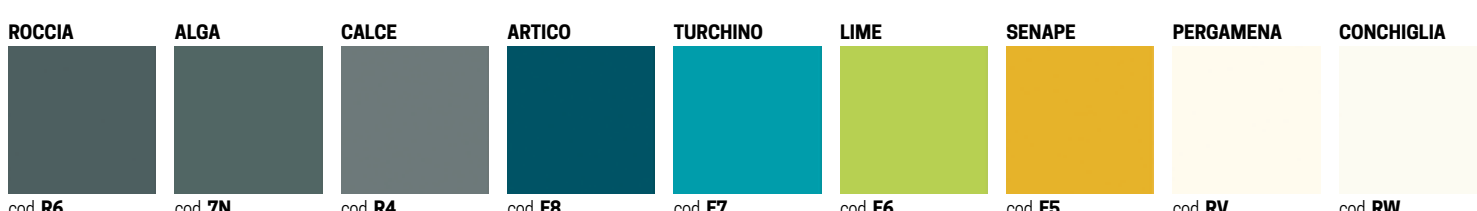
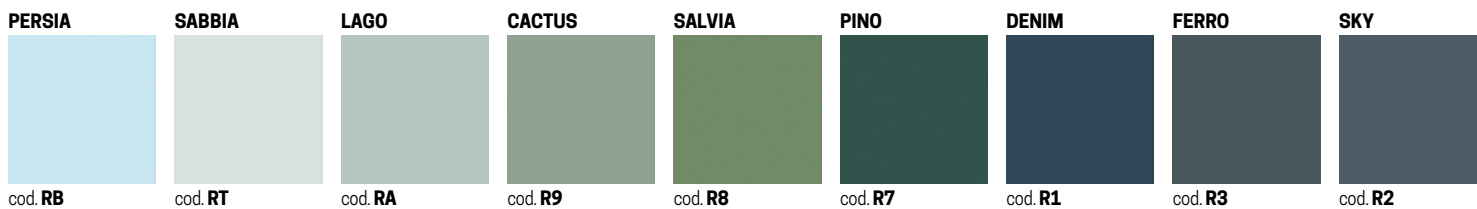
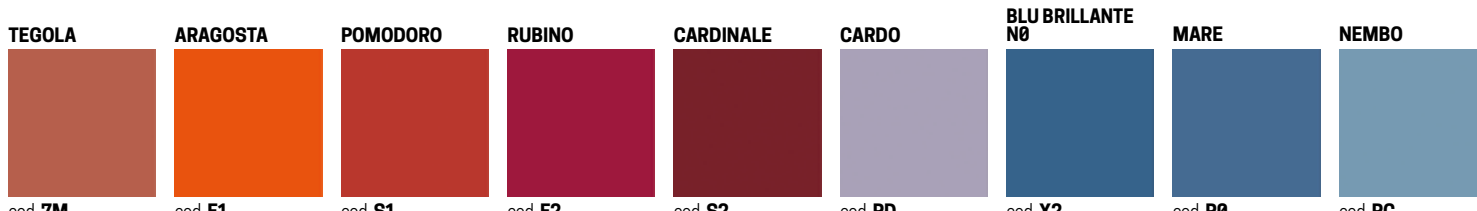
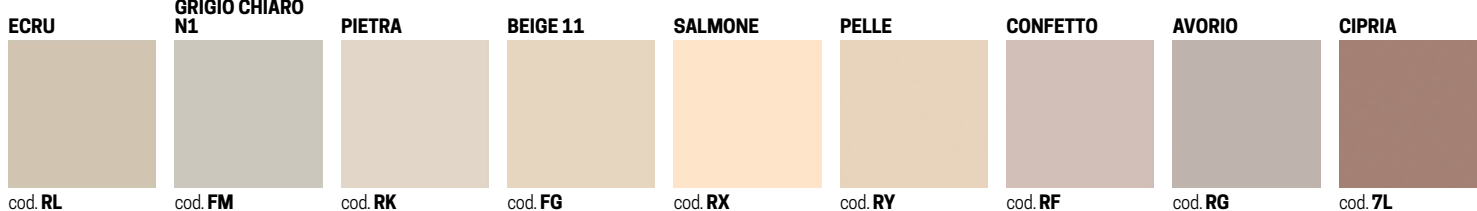
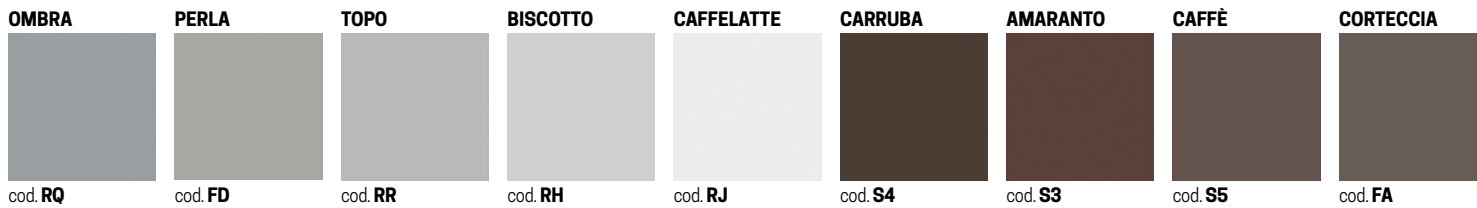
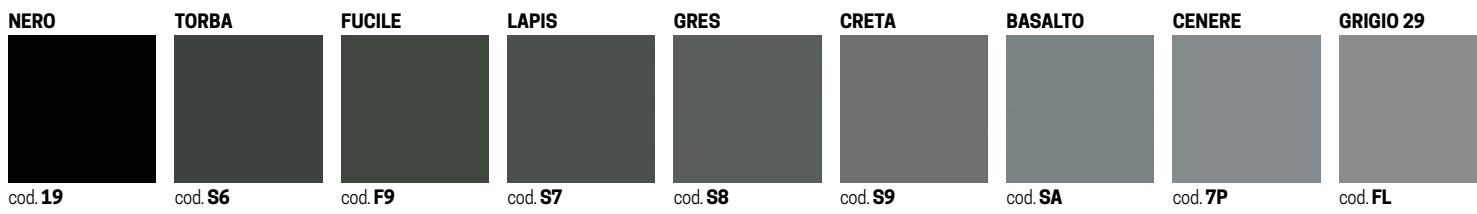

OPTIONAL



BAÑERA BLANCO MATE / BRANCO MATE CON PANEL ARCILLA TÓRTOLA



BAÑERA BLANCO MATE/BRANCO MATE CON PANEL GRAIN+MARCO NEGRO MATE

DIVINA DUAL | ACABADOS PANELES

LAMINADO



Blanco brillo
Branco brilhante

Blanco mate
Branco mate

ACABADO MADERA



Blanco rayado

Grain

Burlington

Dolomite

ARCILLA

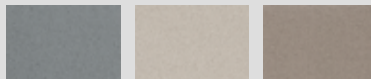

Ceniza

Polvo

Tórtola

MDI



Umbrá

Sabbia

MARCO DE ALUMINIO NEGRO MATE



Blanco mate
Branco mate

Blanco rayado

Grain

Burlington

Dolomite

Ceniza

Polvo

Tórtola

Umbrá

Sabbia

MARCO DE ALUMINIO BLANCO MATE / BRANCO MATE

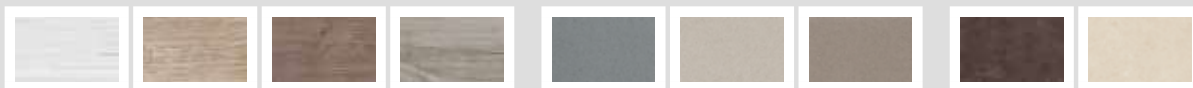

Blanco rayado

Grain

Burlington

Dolomite

Ceniza

Polvo

Tórtola

Umbrá

Sabbia

DIVINA DUAL | EQUIPAMIENTO Y FUNCIONES (disponibles según versión)



Masaje Airpool mediante jets de aire con regulación manual on/off o programa secuencial, para una **estimulación celular eficaz.**

Massagem Airpool através de jets de ar com regulação manual on/off ou programa sequencial, para uma **estimulação celular eficaz.**



Masaje corporal Whirlpool aire/agua con regulación de tiempo e intensidad manual o automática para satisfacer cualquier necesidad de bienestar.

Massagem corpo Whirlpool ar/agua com regulação de tempo e intensidade manual ou automática.



Natural air

8 jets laterales Whirlpool con Cromolight
8 jets laterais Whirlpool com Cromolight



Encendido táctil
Ligação Soft touch



Reposacabezas
Apoia-cabeças



Desinfección
Desinfecção



Grifería al borde de la bañera + Tubo de desagüe anti-gotas



Torneira no rebordo da banheira + Tubo de descarga salvagotas



Válvula Click-Clack



Cascada
Cascata

CONFIGURA ESTA SERIE EN WWW.NOVELLINI.COM/DIVINA



BAÑERA BLANCO MATE/BRANCO MATE CON MARCO NEGRO MATE



Estructura Frame

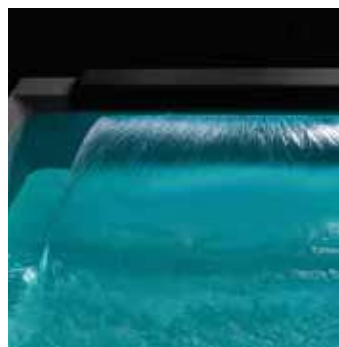

Cascada
Cascata



Envuelve el cuerpo con una suave nube de oxígeno gracias al sistema Natural Air
Envolve o corpo com uma nuvem suave de oxigênio graças ao sistema Natural Air



Grifería
Misturadora

DIVINA

DIVINA DUAL



DIVINA DUAL

BAÑERA RECTANGULAR PARA DOS PERSONAS

S IZQUIERDA / ESQUERDA D DERECHA / DIREITA

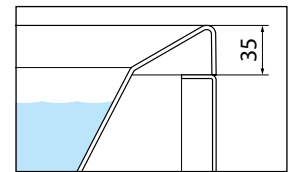
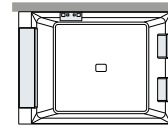
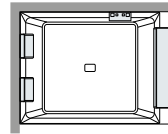

BORDE/REBORDO - 3,5 CM

Medidas	litros litros	Código	instalación		Selección grifería y acabado de la bañera				Selección Estructura / paneles Seleção Opções / painéis	
			Derecha Direita	Izquierda Esquerda	Columna de desagüe sin grifería		Columna de desagüe con grifería		solo estructura só estrutura	con paneles com painéis
Cm	H	Lt.			Blanco brillo Branco brilho	Blanco mate Branco mate	Blanco brillo Branco brilho	Blanco mate Branco mate		

STANDARD CON SOPORTE STANDARD COM SUPORTE																				
					D	S	0-A	0-U	2-A	2-U	0K	* ver tabla seleccionar número de paneles + acabado								
	190x140	63	650	DI219014	D	S	4.452 €	4.592 €												
Para empotrar con grifería	190x140	63	650	DI219N14	D	S	-	-	5.830 €	5.970 €										
WHIRLPOOL CON SOPORTE WHIRLPOOL COM SUPORTE																				
	190x140	63	650	DI5190140	D	S	6.678 €	6.818 €												
Para empotrar con grifería	190x140	63	650	DI519N140	D	S	-	-	8.056 €	8.196 €										
WHIRLPOOL+AIRPOOL CON SOPORTE WHIRLPOOL + AIRPOOL COM SUPORTE																				
	190x140	63	650	DI4190140	D	S	8.904 €	9.044 €												
Para empotrar con grifería	190x140	63	650	DI419N140	D	S	-	-	10.282 €	10.422 €										
WHIRLPOOL + CASCADA CON SOPORTE WHIRLPOOL + CASCADA COM SUPORTE																				
	190x140	63	650	DIW190140	D	S	9.461 €	9.600 €												
Para empotrar con grifería	190x140	63	650	DIW19N140	D	S	-	-	10.839 €	10.978 €										
WHIRLPOOL+ NATURAL AIR CON SOPORTE WHIRLPOOL + NATURAL AIR COM SUPORTE																				
	190x140	63	650	DIN190140	D	S	10.296 €	10.435 €												
Para empotrar con grifería	190x140	63	650	DIN19N140	D	S	-	-	11.674 €	11.813 €										
WHIRLPOOL+NATURAL AIR+CASCADA CON SOPORTE WHIRLPOOL+NATURAL AIR+CASCADA COM SUPORTE																				
	190x140	63	650	DIP190140	D	S	11.687 €	11.826 €												
Para empotrar con grifería	190x140	63	650	DIP19N140	D	S	-	-	13.065 €	13.204 €										



GRIFERÍA COLOR NEGRO MATE BAJO PEDIDO: + 233 €

PARA TODAS LAS OPCIONES VER PÁGINA 537

Seleccionar número de paneles				Selección acabado paneles/Seleção acabamento paineis					
				Laminado		Acabado madera			
1 panel/Painel	2 paneles/painels	3 paneles/painels	4 paneles/painels	Blanco brillo Branco brilhante	Blanco mate Branco mate	Blanco rayado	Grain	Burlington	Dolomite
1	2	3	4	A	U	I	M	N	X
	-	-	-	+ 557 €	+ 585 €	+ 628 €			
-		-	-	+ 919 €	+ 974 €	+ 1.044 €			
-	-		-	+ 1.224 €	+ 1.295 €	+ 1.392 €			
-	-	-		+ 1.837 €	+ 1.948 €	+ 2.087 €			

Construcción del código de la bañera sin paneles **Código** + Selección de desagüe/llenado+acabado bañera **Seleção de valvulas/enchimento + acabamento banheira** + selección estructura sin paneles = Código completo del producto
 Código completo do produto

Construcción del código de la bañera con paneles **Código** + Selección de desagüe/llenado+acabado bañera **Seleção de valvulas/enchimento + acabamento banheira** + selección estructura con paneles (laminado o acabado madera) = Código completo del producto
 Código completo do produto

PARA LA VERSIÓN CON PANELES EN ACABADO ARCILLA / FRAME PEDIR: 1 CÓDIGO BAÑERA SOLO ESTRUCTURA + 1 CÓDIGO PANEL ARCILLA / FRAME (ADJUNTO)

Instalaciones ver pag. 399	Seleccionar número de paneles		Selección acabado paneles / Seleção acabamento paineis																	
		ARCILLA	MARCO NEGRO MATE						MARCO BLANCO MATE / BRANCO MATE											
			ACABADO MADERA			ARCILLA			MDI			ACABADO MADERA			ARCILLA			MDI		
1 panel/Painel	Cenere Polvo Tórtola	Blanco mate Branco mate	Blanco rayado	Grain	Burlington	Ceniza	Polvo	Tórtola	Umbr Sabbia	Blanco rayado	Grain	Burlington	Ceniza	Polvo	Tórtola	Umbr Sabbia				
1	R O S	HU	HI	HM	HN	HG	HO	HS	H1	H2	UI	UM	UN	UG	UO	US	U1	U2		
	PANV1FDI19D-	873 €	601 €			1.147 €			1.147 €			601 €			1.147 €			1.147 €		
	PANV1F1LDI19914-	1.720 €	-			-			-			-			-			-		
Derecha Direita Izquierda Esquerda	PANV1F1LDI1991D-	-	1.365 €			2.266 €			2.266 €			1.365 €			2.266 €			2.266 €		
	PANV1F2LDI19914-	2.239 €	-			-			-			-			-			-		
Derecha Direita Izquierda Esquerda	PANV1F2LDI1991D-	-	2.184 €			2.402 €			2.402 €			2.184 €			2.402 €			2.402 €		
	PANV2F2LDI19914-	3.440 €	2.511 €			4.532 €			4.532 €			2.511 €			4.532 €			4.532 €		

COLORES ESPECIALES BAJO PEDIDO PARA PANELES DE ARCILLA / CORES ESPECIAIS A PEDIDO PARA PAINÉIS DE ARGILA

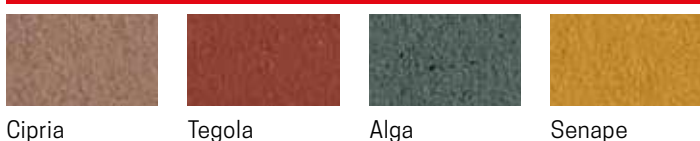

PANELES	Precio / Preço
1-2 paneles	+201 €
3-4 paneles	+403 €

Cipria

Tegola

Alga

Senape



DIVINA F | ACABADOS PANELES

PANELES



Blanco brillo
Branco brilhante

Blanco mate
Branco mate

DIVINA F | EQUIPAMIENTO Y FUNCIONES (disponibles según versión)

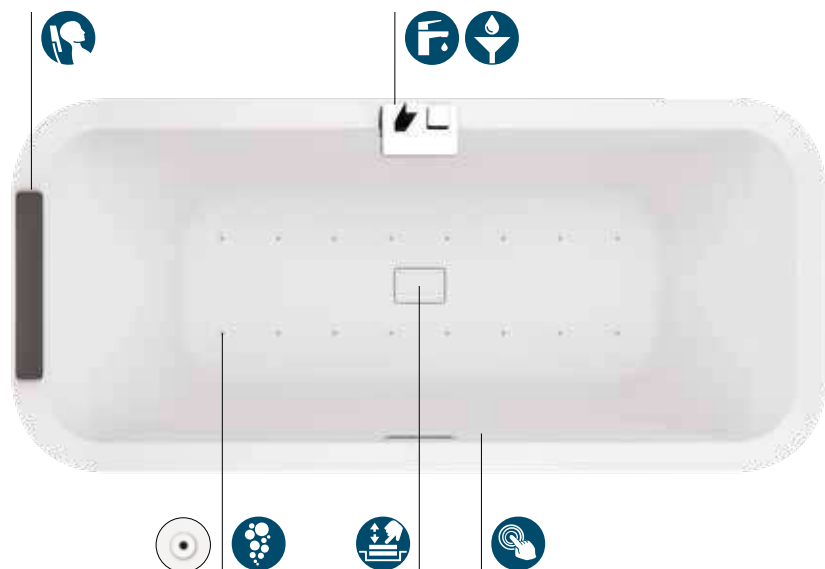

Masaje Airpool mediante jets de aire con regulación manual on/off o programa secuencial, para una **estimulación celular eficaz**.
Massagem Airpool através de jets de ar com regulação manual on/off ou programa sequencial, para uma **estimulação celular eficaz**.



Encendido táctil
Ligação Soft touch.



Reposa-cabezas
Apoia-cabeças



Grifería al borde de la bañera + Tubo de desagüe anti-gotas
Torneira no rebordo da banheira + Tubo de descarga salvagotas



Válvula Click-Click



Hidromasaje Airpool oxigena y regenera las células de la piel.
Hidromassage Airpool oxigena e regenera as células da pele.



Anillo embellecedor con repisa y toallero de acero inoxidable
Anel embelezador com suporte e toalheiro em aço inox



Grifería para borde de bañera con tubo de desagüe anti-gota
Misturadora para bordo de banheira e tubo de desagüe anti-gota



Encendido táctil
Ligaçao soft touch

DIVINA

DIVINA F



DIVINA F

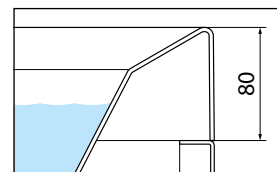

BORDE/REBORDO - 8 CM



Medidas		litros	Código	Selección grifería y acabado de la bañera			
Cm	H	Lt.		Columna de desagüe sin grifería		Columna de desagüe con grifería	
				Blanco brillo Branco brilho	Blanco mate Branco mate	Blanco brillo Branco brilho	Blanco mate Branco mate
STANDAR PARA EMPOTRAR STANDAR PARA EMBUTIR							
180 x 80	63	300	DI11808C	-A	-U	2-A0K	2-U0K
				1.155 €	1.259 €	1.956 €	2.060 €
STANDARD CON SOPORTE STANDARD COM SUPORTE							
180 x 80	63	300	DI21808C	-A1A	-U1U	2-A1A	2-U1U
				4.014 €	4.117 €	4.800 €	4.903 €
HYDRO AIR							
180 x 80	63	300	DIY1808CO	0-A1A	0-U1U	2-A1A	2-U1U
				5.433 €	5.536 €	6.219 €	6.322 €

PARA TODAS LAS OPCIONES VER PÁGINA 536,537

DIVINA F B35

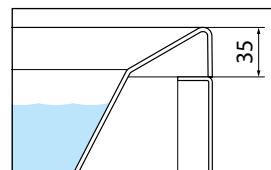

BORDE/REBORDO - 3,5 CM



Medidas		litros	Código	Selección grifería y acabado de la bañera			
Cm	H	Lt.		Columna de desagüe sin grifería		Columna de desagüe con grifería	
				Blanco brillo Branco brilho	Blanco mate Branco mate	Blanco brillo Branco brilho	Blanco mate Branco mate
STANDAR PARA EMPOTRAR STANDAR PARA EMBUTIR							
				-A	-U	2-A0K	2-U0K
180 x 80	63	300	D111898C	1.155 €	1.259 €	1.956 €	2.060 €

PARA TODAS LAS OPCIONES VER PÁGINA 536,537

Construcción del código: **Código** + **Acabado bañera** = Código completo del producto
 Construção do código: **Código** + **Acabamentos** = Código completo do produto



BAÑERA BLANCO MATE / BRANCO MATE CON PANEL BURLINGTON



BAÑERA BLANCO MATE / BRANCO MATE CON PANEL BLANCO MATE / BRANCO MATE

DIVINA C | ACABADOS PANELES

PANELES



Blanco brillo
Branco brilhante

Blanco mate
Branco mate

PANELES ARCILLA

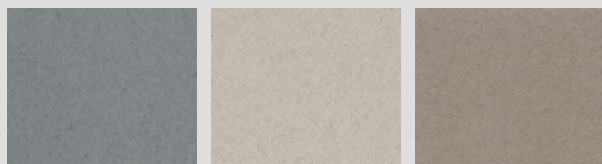

Ceniza

Polvo

Tórtola

PANELES ACABADO MADERA

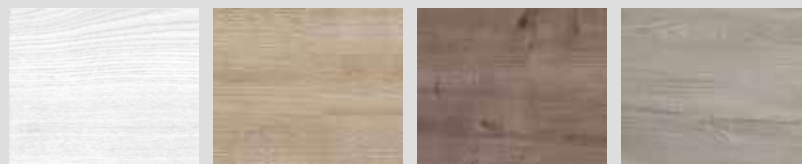

Blanco rayado

Grain

Burlington

Dolomite

DIVINA C | EQUIPAMIENTO Y FUNCIONES (disponibles según versión)



Masaje Airpool mediante jets de aire con regulación manual on/off o programa secuencial, para una **estimulación celular eficaz.**

Massagem Airpool através de jets de ar com regulação manual on/off ou programa sequencial, para uma **estimulação celular eficaz.**



Masaje corporal Whirlpool aire/agua con regulación de tiempo e intensidad manual o automática para satisfacer cualquier necesidad de bienestar.

Massagem corpo Whirlpool ar/agua com regulação de tempo e intensidade manual ou automática.



Natural air

8 posiciones cromáticas a partir del sistema CROMOLIGHT para activar la mente y sentir la emoción del espíritu.

8 posições cromáticas a partir do sistema Cromolight para activar a mente e sentir a emoção do espírito.



Encendido táctil
Ligação Soft touch.



Reposa-cabezas
Apoia-cabeças



Grifería al borde de la bañera + Tubo de desagüe anti-gotas



Torneira no rebordo da banheira + Tubo de descarga salvagotas



Válvula Click-Clack

CONFIGURA ESTA SERIE EN WWW.NOVELLINI.COM/DIVINA



BAÑERA BLANCO MATE / BRANCO MATE CON PANEL ARCILLA CENIZA



Grifería
Torneira

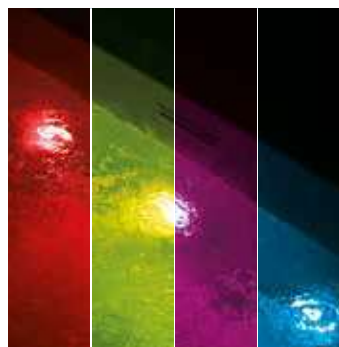

Jets de hidromasaje con Cromolight integrado para estimular el cuerpo y las emociones
Jets de hidromassagem com Cromolight integrado para estimular o corpo e as emoções



Envuelve tu cuerpo con una suave nube de oxígeno gracias al sistema Natural Air
Envolve o corpo com uma nuvem suave de oxigênio graças ao sistema Natural Air



Encendido táctil
Ligaçãõ Soft touch

DIVINA



DIVINA C











DIVINA C

BAÑERA SEMICIRCULAR ANGULAR, SIMETRICA BANHEIRA SEMICIRCULAR ANGULAR, SIMETRICA

Design Massimo Farinatti

Medidas			litros	Código	Selección columna de desagüe, grifería y acabado de la bañera Seleção de valvulas/enchimento + acabamento banheira						selección estructura / paneles seleção opções / paineis	
Cm	H	Lt.			Columna de desagüe sin grifería		Columna de desagüe con sistema de llenado		Columna de desagüe con grifería		sin paneles sem paineis	con paneles com paineis
					Blanco brillo Branco brilho	Blanco mate Branco mate	Blanco brillo Branco brilho	Blanco mate Branco mate	Blanco brillo Branco brilho	Blanco mate Branco mate		

STANDAR PARA EMPOTRAR STANDAR PARA EMBUTIR											
				0-A	0-U	1-A	1-U	2-A	2-U		
140 X140	63	400	DI1140149	1.155 €	1.259 €	1.230 €	1.333 €	1.956 €	2.060 €		
STANDARD CON SOPORTE STANDARD COM SUPORTE											
140 X140	63	400	DI2140149	1.541 €	1.645 €	1.614 €	1.717 €	2.327 €	2.431 €	0K	* ver tabla seleccionar número de paneles + acabado
HYDRO AIR											
140 X140	63	400	DIY1401490	2.389 €	2.493 €	2.462 €	2.565 €	3.175 €	3.279 €	0K	* ver tabla seleccionar número de paneles + acabado
WHIRLPOOL											
140 X140	63	400	DI51401490	2.629 €	2.733 €	2.702 €	2.806 €	3.415 €	3.518 €	0K	* ver tabla seleccionar número de paneles + acabado
HYDRO PLUS											
140 X140	63	400	DI41401490	4.608 €	4.711 €	4.680 €	4.784 €	5.393 €	5.496 €	0K	* ver tabla seleccionar número de paneles + acabado
NATURAL AIR											
140 X140	63	400	DIN1401490	3.366 €	3.469 €	3.439 €	3.543 €	4.152 €	4.255 €	0K	* ver tabla seleccionar número de paneles + acabado
NATURAL AIR + HYDRO											
140 X140	63	400	DIP1401490	5.411 €	5.515 €	5.484 €	5.588 €	6.198 €	6.301 €	0K	* ver tabla seleccionar número de paneles + acabado

 GRIFERÍA COLOR NEGRO MATE BAJO PEDIDO: + 133 €

PARA TODAS LAS OPCIONES VER PÁGINA 536,537



BAÑERA BLANCO MATE / BRANCO MATE CON PANEL ARCILLA POLVO

	Selección acabado paneles/Seleção acabamento paineis								
	LAMINADO		ACABADO MADERA				ARCILLA		
	1 panel Acabado bañera Blanco brillo 1 painel Acabamentos Branco brilhante	1 panel Acabado bañera Blanco mate 1 painel Acabamentos Branco mate	Blanco rayado	Grain	Burlington	Dolomite	Ceniza	Polvo	Tórtola
	1A	1U	1I	1M	1N	1X	1R	1O	1S
	+ 479 €		+ 847 €				+ 1.161 €		

COLORES ESPECIALES BAJO PEDIDO PARA PANELES DE ARCILLA / CORES ESPECIAIS A PEDIDO PARA PAINÉIS DE ARGILA

				PANELES	Precio / Preço
Cipria	Tegola	Alga	Senape	1 panel	+133 €

Construcción del código de la bañera sin paneles **Código** + Selección de desagüe/llenado+acabado bañera *Seleção de valvulas/enchimento + acabamento banheira* + selección estructura sin paneles = Código completo del producto *Código completo do produto*

Construcción del código de la bañera con paneles **Código** + Selección de desagüe/llenado+acabado bañera *Seleção de valvulas/enchimento + acabamento banheira* + selección estructura con paneles (laminado o acabado madera) = Código completo del producto *Código completo do produto*

DIVINA



BAÑERA BLANCO MATE / BRANCO MATE CON PANEL ARCILLA TÓRTOLA



BAÑERA BLANCO MATE / BRANCO MATE CON PANEL BLANCO MATE / BRANCO MATE

DIVINA O | ACABADOS PANELES

PANELES



Blanco brillo
Branco brilhante

Blanco mate
Branco mate

PANELES ARCILLA

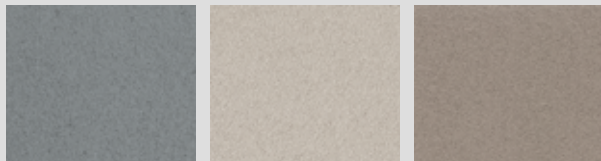

Ceniza

Polvo

Tórtola

PANELES ACABADO MADERA

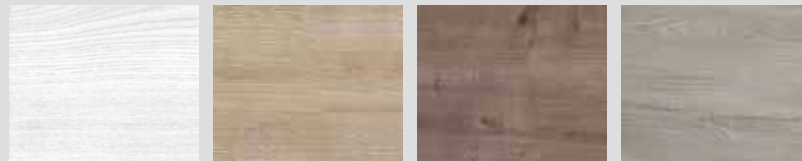

Blanco rayado

Grain

Burlington

Dolomite

DIVINA O | EQUIPAMIENTO Y FUNCIONES (disponibles según versión)



Masaje Airpool mediante jets de aire con regulación manual on/off o programa secuencial, para una **estimulación celular eficaz**.

Massagem Airpool através de jets de ar com regulação manual on/off ou programa sequencial, para uma **estimulação celular eficaz**.



Masaje corporal Whirlpool aire/agua con regulación de tiempo e intensidad manual o automática para satisfacer cualquier necesidad de bienestar.

Massagem corpo Whirlpool ar/agua com regulação de tempo e intensidade manual ou automática.



Natural air

8 posiciones cromáticas a partir del sistema CROMOLIGHT para activar la mente y sentir la emoción del espíritu.

8 posições cromáticas a partir do sistema Cromolight para activar a mente e sentir a emoção do espírito.



Encendido táctil
Ligação Soft touch.



Reposa-cabezas
Apoia-cabeças



Grifería al borde de la bañera + Tubo de desagüe anti-gotas



Torneira no rebordo da banheira + Tubo de descarga salvagotas



Válvula Click-Clack

CONFIGURA ESTA SERIE EN WWW.NOVELLINI.COM/DIVINA



BAÑERA BLANCO MATE / BRANCO MATE CON PANEL BURLINGTON



Grifería
Torneira

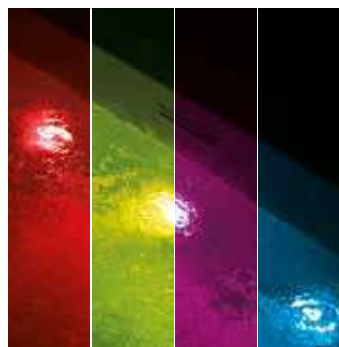

Jets de hidromasaje con Cromolight integrado para estimular el cuerpo y las emociones
Jets de hidromassagem com Cromolight integrado para estimular o corpo e as emoções



Envuelve tu cuerpo con una suave nube de oxígeno gracias al sistema Natural Air
Envolve o corpo com uma nuvem suave de oxigênio graças ao sistema Natural Air



Encendido táctil
Ligação Soft touch

DIVINA

DIVINA 0



DIVINA 0

BAÑERA ANGULAR ASIMÉTRICA ANGULAR BANHEIRA ASIMÉTRICA

Design Massimo Farinatti

S VERS. IZQUIERDA
ESQUERDA

D VERS. DERECHA
DIREITA

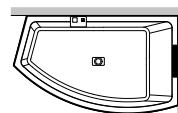
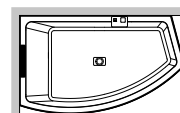

Medidas	litros	Código	instalación		Selección columna de desagüe, grifería y acabado de la bañera Seleção de valvulas/enchimento + acabamento banheira						selección estructura / paneles seleção opções / paineis		
			Derecha Direita	Izquierda Esquerda	Columna de desagüe sin grifería Blanco brillo Blanco mate Branco brilho Branco mate		Columna de desagüe con sistema de llenado Blanco brillo Blanco mate Branco brilho Branco mate		Columna de desagüe con grifería Blanco brillo Blanco mate Branco brilho Branco mate		sin paneles sem paineis	con paneles com paineis	
Cm	H	Lt.											

STANDAR PARA EMPOTRAR STANDAR PARA EMBUTIR

				D	S	0-A	0-U	1-A	1-U	2-A	2-U	0K	
165 X 98	63	360	DI116599			1.081 €	1.185 €	1.155 €	1.259 €	1.882 €	1.985 €		

STANDARD CON SOPORTE STANDARD COM SUPORTE

				D	S	0-A	0-U	1-A	1-U	2-A	2-U	0K	
165 X 98	63	360	DI216599			1.471 €	1.574 €	1.544 €	1.647 €	2.257 €	2.361 €		* ver tabla seleccionar número de paneles + acabado

HYDRO AIR

				D	S	0-A	0-U	1-A	1-U	2-A	2-U	0K	
165 X 98	63	360	DIY165990			2.318 €	2.421 €	2.390 €	2.494 €	3.104 €	3.207 €		* ver tabla seleccionar número de paneles + acabado

WHIRLPOOL

				D	S	0-A	0-U	1-A	1-U	2-A	2-U	0K	
165 X 98	63	360	DI5165990			2.559 €	2.663 €	2.632 €	2.735 €	3.344 €	3.448 €		* ver tabla seleccionar número de paneles + acabado

HYDRO PLUS

				D	S	0-A	0-U	1-A	1-U	2-A	2-U	0K	
165 X 98	63	360	DI4165990			4.536 €	4.640 €	4.609 €	4.712 €	5.321 €	5.425 €		* ver tabla seleccionar número de paneles + acabado

NATURAL AIR

				D	S	0-A	0-U	1-A	1-U	2-A	2-U	0K	
165 X 98	63	360	DI-N165990			3.296 €	3.399 €	3.369 €	3.472 €	4.081 €	4.185 €		* ver tabla seleccionar número de paneles + acabado

NATURAL AIR + HYDRO

				D	S	0-A	0-U	1-A	1-U	2-A	2-U	0K	
165 X 98	63	360	DIP165990			5.341 €	5.445 €	5.414 €	5.517 €	6.127 €	6.231 €		* ver tabla seleccionar número de paneles + acabado



GRIFERÍA COLOR NEGRO MATE BAJO PEDIDO: + 133 €

PARA TODAS LAS OPCIONES VER PÁGINA 536,537



BAÑERA BLANCO MATE / BRANCO MATE CON PANEL BLANCO RAYADO

	Selección acabado paneles/Seleção acabamento paineis								
	LAMINADO		ACABADO MADERA				ARCILLA		
	1 panel Acabado bañera Blanco brillo 1 painel Acabamentos Branco brilhante	1 panel Acabado bañera Blanco mate 1 painel Acabamentos Branco mate	Blanco rayado	Grain	Burlington	Dolomite	Ceniza	Polvo	Tórtola
	1A	1U	1I	1M	1N	1X	1R	1O	1S
	+ 479 €		+ 847 €				+ 1.161 €		

COLORES ESPECIALES BAJO PEDIDO PARA PANELES DE ARCILLA / CORES ESPECIAIS A PEDIDO PARA PAINÉIS DE ARGILA

				PANELES	Precio / Preço
Cipria	Tegola	Alga	Senape	1 panel	+133 €

Construcción del código de la bañera sin paneles **Código** + Selección de desagüe/llenado+acabado bañera / Seleção de valvulas/enchimento + acabamento banheira + selección estructura sin paneles = Código completo del producto / Código completo do produto

Construcción del código de la bañera con paneles **Código** + Selección de desagüe/llenado+acabado bañera / Seleção de valvulas/enchimento + acabamento banheira + selección estructura con paneles (laminado o acabado madera) = Código completo del producto / Código completo do produto

DIVINA



CENTRO DE PARED - PANEL BLANCO MATE / BRANCO MATE



ESQUINA ÁNGULO - PANEL BURLINGTON

DIVINA W | ACABADOS PANELES

PANELES



Blanco brillo
Branco brilhante

Blanco mate
Branco mate

PANELES ARCILLA

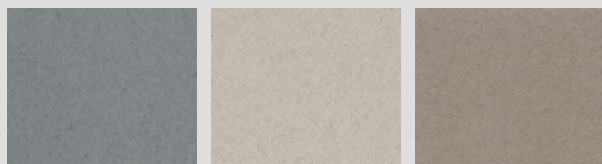

Ceniza

Polvo

Tórtola

PANELES ACABADO MADERA

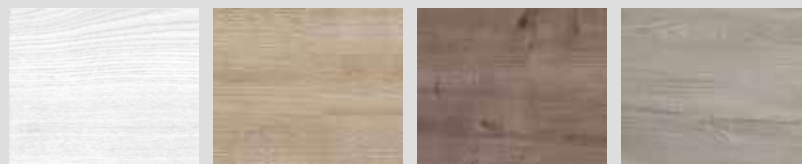

Blanco rayado

Grain

Burlington

Dolomite

DIVINA W | EQUIPAMIENTO Y FUNCIONES (disponibles según versión)



Masaje Airpool mediante jets de aire con regulación manual on/off o programa secuencial, para una **estimulación celular eficaz**.

Massagem Airpool através de jets de ar com regulação manual on/off ou programa sequencial, para uma **estimulação celular eficaz**.

Masaje corporal Whirlpool aire/agua con regulación de tiempo e intensidad manual o automática para satisfacer cualquier necesidad de bienestar.

Massagem corpo Whirlpool ar/agua com regulação de tempo e intensidade manual ou automática.

Natural air

8 posiciones cromáticas a partir del sistema CROMOLIGHT para activar la mente y sentir la emoción del espíritu.

8 posições cromáticas a partir do sistema Cromolight para activar a mente e sentir a emoção do espírito.

Encendido táctil
Ligação Soft touch.

Reposa-cabezas
Apoia-cabeças

Grifería al borde de la bañera + Tubo de desagüe anti-gotas

Torneira no rebordo da banheira + Tubo de descarga salvagotas

Válvula Click-Clack



ESQUINA ÁNGULO - PANEL ARCILLA CENIZA



Grifería
Torneira

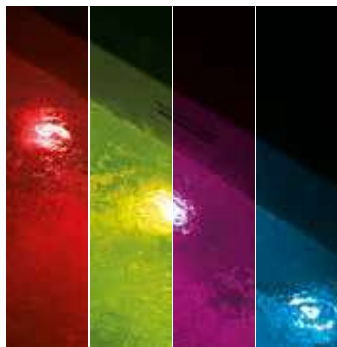

Jets de hidromasaje con
Cromolight integrado para
estimular el cuerpo y las emociones
*Jets de hidromassagem com
Cromolight integrado para
estimular o corpo e as emoções*



Envuelve tu cuerpo con una
suave nube de oxígeno gracias
al sistema Natural Air
*Envolve o corpo com uma
nuvem suave de oxigênio graças
ao sistema Natural Air*



Encendido táctil
Ligação Soft touch

DIVINA

DIVINA W

DIVINA W

Medidas			litros	Código	Selección columna de desagüe, grifería y acabado de la bañera Seleção de valvulas/enchimento + acabamento banheira						selección estructura / paneles seleção opções / painéis	
Cm	H	Lt.			Columna de desagüe sin grifería		Columna de desagüe con sistema de llenado		Columna de desagüe con grifería		sin paneles sem painéis	con paneles com painéis
				Blanco brillo Branco brilho	Blanco mate Branco mate	Blanco brillo Branco brilho	Blanco mate Branco mate	Blanco brillo Branco brilho	Blanco mate Branco mate			
STANDAR PARA EMPOTRAR STANDAR PARA EMBUTIR												
				0-A	0-U	1-A	1-U	2-A	2-U	0K	* ver tabla seleccionar número de paneles + acabado	
180 X 80	63	320	DI11808W	1.144 €	1.248 €	1.218 €	1.322 €	1.929 €	2.033 €			
STANDARD CON SOPORTE STANDARD COM SUPORTE												
				0-A	0-U	1-A	1-U	2-A	2-U	0K		
180 X 80	63	320	DI21808W	1.545 €	1.648 €	1.620 €	1.723 €	2.331 €	2.435 €			
HYDRO AIR												
				0-A	0-U	1-A	1-U	2-A	2-U	0K	* ver tabla seleccionar número de paneles + acabado	
180 X 80	63	320	DIY1808WO	2.908 €	3.010 €	2.982 €	3.085 €	3.693 €	3.797 €			
WHIRLPOOL												
				0-A	0-U	1-A	1-U	2-A	2-U	0K	* ver tabla seleccionar número de paneles + acabado	
180 X 80	63	320	DI51808WO	3.209 €	3.311 €	3.283 €	3.386 €	3.994 €	4.097 €			
HYDRO PLUS												
				0-A	0-U	1-A	1-U	2-A	2-U	0K	* ver tabla seleccionar número de paneles + acabado	
180 X 80	63	320	DI41808WO	5.689 €	5.792 €	5.763 €	5.866 €	6.474 €	6.577 €			
NATURAL AIR												
				0-A	0-U	1-A	1-U	2-A	2-U	0K	* ver tabla seleccionar número de paneles + acabado	
180 X 80	63	320	DIN1808WO	4.133 €	4.237 €	4.207 €	4.311 €	4.918 €	5.022 €			
NATURAL AIR + WHIRLPOOL												
				0-A	0-U	1-A	1-U	2-A	2-U	0K	* ver tabla seleccionar número de paneles + acabado	
180 X 80	63	320	DIP1808WO	6.701 €	6.804 €	6.776 €	6.878 €	7.487 €	7.590 €			



CENTRO DE PARED - PANEL BURLINGTON

Scelta numero pannelli	Selección acabado paneles/Seleção acabamento paineis								
	LAMINADO		ACABADO MADERA				ARCILLA		
	Blanco brillo Branco brilhante	Blanco mate Branco mate	Blanco rayado	Grain	Burlington	Dolomite	Ceniza	Polvo	Tórtola
1 panel centro de pared	CA	CU	CI	CM	CN	CX	CR	CO	CS
	+ 597 €	+ 716 €	+ 967 €				+ 1.280 €		
1 panel ángulo derecha	DA	DU	DI	DM	DN	DX	DR	DO	DS
	+ 597 €	+ 716 €	+ 967 €				+ 1.280 €		
1 panel ángulo izquierda	SA	SU	SI	SM	SN	SX	SR	SO	SS
	+ 597 €	+ 716 €	+ 967 €				+ 1.280 €		

Construcción del código de la bañera sin paneles **Código** + Selección de desagüe/llenado+acabado bañera / Seleção de valvulas/enchimento + acabamento banheira + selección estructura sin paneles = Código completo del producto / Código completo do produto

Construcción del código de la bañera con paneles **Código** + Selección de desagüe/llenado+acabado bañera / Seleção de valvulas/enchimento + acabamento banheira + selección estructura con paneles (laminado o acabado madera) = Código completo del producto / Código completo do produto

GRIFERÍA COLOR NEGRO MATE BAJO PEDIDO: + 133 €

COLORES ESPECIALES BAJO PEDIDO PARA PANELES DE ARCILLA / CORES ESPECIAIS A PEDIDO PARA PAINÉIS DE ARGILA

	PANELES	Precio / Preço
	1 panel angulo	+133 €
	1 panel centro de pared	+266 €

DIVINA



BAÑERA BLANCO MATE / BRANCO MATE CON PANEL ARCILLA TÓRTOLA



BAÑERA BLANCO MATE/BRANCO MATE CON PANEL BURLINGTON+MARCO BLANCO MATE

DIVINA | ACABADOS PANELES

LAMINADO

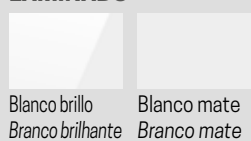

ACABADO MADERA

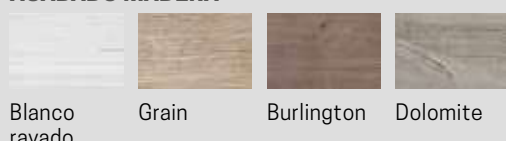

ARCILLA

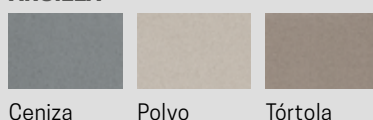

MDI

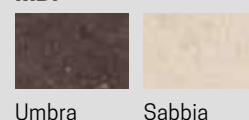

MARCO DE ALUMINIO NEGRO MATE

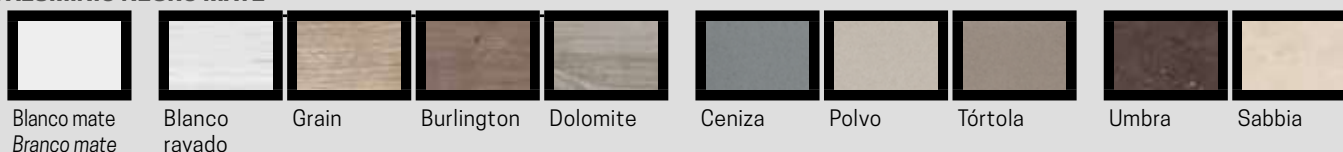

MARCO DE ALUMINIO BLANCO MATE / BRANCO MATE

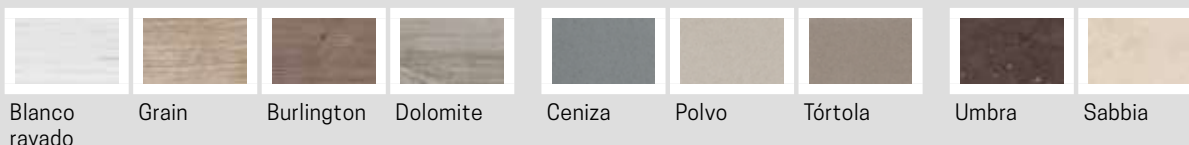

DIVINA | EQUIPAMIENTO Y FUNCIONES (disponibles según versión)

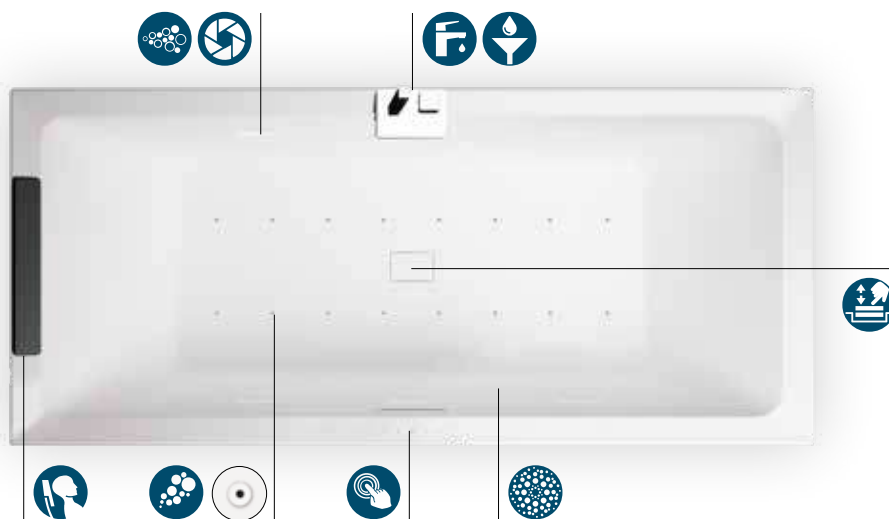

Masaje Airpool mediante jets de aire con regulación manual on/off o programa secuencial, para una **estimulación celular eficaz.**

Massagem Airpool através de jets de ar com regulação manual on/off ou programa sequencial, para uma **estimulação celular eficaz.**



Masaje corporal Whirlpool aire/agua con regulación de tiempo e intensidad manual o automática para satisfacer cualquier necesidad de bienestar.

Massagem corpo Whirlpool ar/agua com regulação de tempo e intensidade manual ou automática.



Natural air

8 posiciones cromáticas a partir del sistema CROMOLIGHT para activar la mente y sentir la emoción del espíritu.

8 posições cromáticas a partir do sistema Cromolight para activar a mente e sentir a emoção do espírito.



Encendido táctil
Ligação Soft touch.



Reposa-cabezas
Apoia-cabeças



Grifería al borde de la bañera + Tubo de desagüe anti-gotas
Torneira no rebordo da banheira + Tubo de descarga salvagotas



Válvula Click-Clack



BAÑERA BLANCO MATE/BRANCO MATE CON PANEL BLANCO MATE/BRANCO MATE



Envuelve el cuerpo con una suave nube de oxígeno gracias al sistema Natural Air
Envolve o corpo com uma nuvem suave de oxigênio graças ao sistema Natural Air

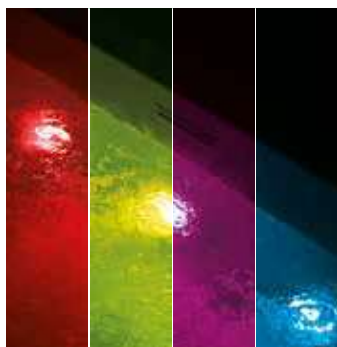

Jets de hidromasaje con Cromolight integrado para estimular el cuerpo y las emociones
jets de hidromassagem com Cromolight integrado para estimular o corpo e as emoções



Panel de control táctil "soft touch" para todas las funciones de la bañera.
Painel de controlo táctil "soft touch" para todas as funções da banheira.



OPCIONAL MAMPARA PARA BAÑERA DIVINA
RESGUARDO DE BANHEIRA OPCIONAL DIVINA
 ver pag. 204 y 206

DIVINA



DIVINA

DIVINA

BAÑERA RECTANGULAR BANHEIRA RECTANGULAR

Medidas			litros	Código	Selección columna de desagüe, grifería y acabado de la bañera Seleção de valvulas/enchimento + acabamento banheira				Selección Estructura / paneles Seleção Opções / painéis			
Cm	H	Lt.			Columna de desagüe sin grifería Blanco brillo Branco brilho		Columna de desagüe con sistema de llenado Blanco mate Branco mate		Columna de desagüe con grifería Blanco brillo Branco brilho		Blanco mate Branco mate	

STANDAR PARA EMPOTRAR STANDAR PARA EMBUTIR											
				-A	-U	1-A0K	1-U0K	2-A0K	2-U0K		
160 x 70	63	250	DI116970	863 €	967 €	937 €	1.041 €	1.663 €	1.767 €		
170 x 70	63	280	DI117970								
170 x 75	63	300	DI117975								
180 x 80	63	350	DI118980	1.155 €	1.259 €	1.230 €	1.333 €	1.956 €	2.060 €		
180 x 100	63	430	DI118910								
190 x 90	63	420	DI119990								

STANDARD CON SOPORTE STANDARD COM SUPORTE											
				-A	-U	1-A	1-U	2-A	2-U	0K	* ver tabla seleccionar número de paneles + acabado
160 x 70	63	250	DI216970	1.101 €	1.205 €	1.174 €	1.277 €	1.887 €	1.991 €		
170 x 70	63	280	DI217970								
170 x 75	63	300	DI217975								
180 x 80	63	350	DI218980	1.380 €	1.483 €	1.452 €	1.556 €	2.166 €	2.268 €		
180 x 100	63	430	DI218910								
190 x 90	63	420	DI219990								

HYDRO AIR											
				0-A	0-U	1-A	1-U	2-A	2-U	0K	* ver tabla seleccionar número de paneles + acabado
160 x 70	63	250	DIY169700	2.479 €	2.583 €	2.552 €	2.655 €	3.265 €	3.369 €		
170 x 70	63	280	DIY179700								
170 x 75	63	300	DIY179750								
180 x 80	63	350	DIY189800	2.758 €	2.861 €	2.830 €	2.934 €	3.544 €	3.646 €		
180 x 100	63	430	DIY189100								
190 x 90	63	420	DIY199900								

WHIRLPOOL											
				0-A	0-U	1-A	1-U	2-A	2-U	0K	* ver tabla seleccionar número de paneles + acabado
160 x 70	63	250	DI5169700	2.716 €	2.819 €	2.788 €	2.892 €	3.501 €	3.604 €		
170 x 70	63	280	DI5179700								
170 x 75	63	300	DI5179750								
180 x 80	63	350	DI5189800	2.993 €	3.097 €	3.067 €	3.169 €	3.779 €	3.883 €		
180 x 100	63	430	DI5189100								
190 x 90	63	420	DI5199900								

HYDRO PLUS											
				0-A	0-U	1-A	1-U	2-A	2-U	0K	* ver tabla seleccionar número de paneles + acabado
160 x 70	63	250	DI4169700	4.664 €	4.768 €	4.737 €	4.841 €	5.451 €	5.553 €		
170 x 70	63	280	DI4179700								
170 x 75	63	300	DI4179750								
180 x 80	63	350	DI4189800	4.943 €	5.046 €	5.016 €	5.119 €	5.728 €	5.832 €		
180 x 100	63	430	DI4189100								
190 x 90	63	420	DI4199900								

Medidas			litros	Código	Selección columna de desagüe, grifería y acabado de la bañera Seleção de valvulas/enchimento + acabamento banheira						Selección Estructura / paneles Seleção Opções / painéis	
Cm	H	Lt.			Columna de desagüe sin grifería		Columna de desagüe con sistema de llenado		Columna de desagüe con grifería		solo estructura só estrutura	con paneles com painéis
					Blanco brillo Branco brilho	Blanco mate Branco mate	Blanco brillo Branco brilho	Blanco mate Branco mate	Blanco brillo Branco brilho	Blanco mate Branco mate		

NATURAL AIR											
				0-A	0-U	1-A	1-U	2-A	2-U	0K	* ver tabla seleccionar número de paneles + acabado
160 x 70	63	250	DIN169700	3.452 €	3.555 €	3.525 €	3.628 €	4.238 €	4.341 €		
170 x 70	63	280	DIN179700								
170 x 75	63	300	DIN179750								
180 x 80	63	350	DIN189800	3.730 €	3.834 €	3.803 €	3.906 €	4.516 €	4.619 €		
180 x 100	63	430	DIN189100								
190 x 90	63	420	DIN199900								

NATURAL AIR + WHIRLPOOL											
				0-A	0-U	1-A	1-U	2-A	2-U	0K	* ver tabla seleccionar número de paneles + acabado
160 x 70	63	250	DIP169700	5.470 €	5.573 €	5.543 €	5.647 €	6.256 €	6.359 €		
170 x 70	63	280	DIP179700								
170 x 75	63	300	DIP179750								
180 x 80	63	350	DIP189800	5.748 €	5.851 €	5.822 €	5.924 €	6.534 €	6.638 €		
180 x 100	63	430	DIP189100								
190 x 90	63	420	DIP199900								

Seleccionar número de paneles				Selección acabado paneles/Seleção acabamento painéis					
				Laminado		Acabado madera			
1 panel/Painel	2 paneles/painéis	3 paneles/painéis	4 paneles/painéis	Blanco brillo Branco brilhante	Blanco mate Branco mate	Blanco rayado	Grain	Burlington	Dolomite
1	2	3	4	A	U	I	M	N	X
	-	-	-	+ 329 €	+ 349 €	+ 376 €			
-		-	-	+ 479 €	+ 507 €	+ 546 €			
-	-		-	+ 670 €	+ 704 €	+ 758 €			
-	-	-		+ 956 €	+ 1.011 €	+ 1.092 €			

PARA OTROS ACABADOS VER LA PÁGINA SIGUIENTE

Construcción del código de la bañera sin paneles **Código** + Selección de desagüe/llenado+acabado bañera Seleção de valvulas/enchimento + acabamento banheira + selección estructura sin paneles = Código completo del producto Código completo do produto

Construcción del código de la bañera con paneles **Código** + Selección de desagüe/llenado+acabado bañera Seleção de valvulas/enchimento + acabamento banheira + selección estructura con paneles (laminado o acabado madera) = Código completo del producto Código completo do produto

GRIFERÍA COLOR NEGRO MATE BAJO PEDIDO: + 133 €

COLORES ESPECIALES BAJO PEDIDO PARA PANELES DE ARCILLA / CORES ESPECIAIS A PEDIDO PARA PAINÉIS DE ARGILA									
Cipria	Tegola	Alga	Senape						
			<table border="1"> <thead> <tr> <th>PANELES</th> <th>Precio / Preço</th> </tr> </thead> <tbody> <tr> <td>1-2 paneles</td> <td>+133 €</td> </tr> <tr> <td>3-4 paneles</td> <td>+266 €</td> </tr> </tbody> </table>	PANELES	Precio / Preço	1-2 paneles	+133 €	3-4 paneles	+266 €
PANELES	Precio / Preço								
1-2 paneles	+133 €								
3-4 paneles	+266 €								

**PARA LA VERSIÓN CON PANELES ACABADO ARCILLA + MARCO: PEDIR: 1 CÓDIGO DE BAÑERA SÓLO CON SOPORTE + 1 CÓDIGO DE PANELES ARCILLA CON MARCO (VER DEBAJO)
 INSTALACION: VER PAG. 550 - SELECCIONAR NÚMERO DE PANELES**

Medidas	CODIGO - Seleccionar número de paneles 	Selección acabado paneles Seleção acabamento paineis				
		ARCILLA			MDI	
	1 panel/Painel	Ceniza	Polvo	Tórtola	Umbrá	Sabbia
	1	R	O	S	1	2
160 x 70	PANV1FDI169-	877 €			877 €	
170 x 70; 170 x 75	PANV1FDI179-					
180 x 80; 180 x 100	PANV1FDI189-					
190 x 90	PANV1FDI199-					

Medidas	CODIGO - Seleccionar número de paneles 	Selección acabado paneles Seleção acabamento paineis				
		ARCILLA			MDI	
	2 paneles/painels	Ceniza	Polvo	Tórtola	Umbrá	Sabbia
	2	R	O	S	1	2
160 x 70	PANV1F1LDI16970-	1.275 €			1.275 €	
170 x 70	PANV1F1LDI17970-					
170 x 75	PANV1F1LDI17975-					
180 x 80	PANV1F1LDI18980-					
180 x 100	PANV1F1LDI18910-					
190 x 90	PANV1F1LDI19990-					

Medidas	CODIGO - Seleccionar número de paneles 	Selección acabado paneles Seleção acabamento paineis				
		ARCILLA			MDI	
	3 paneles/painels	Ceniza	Polvo	Tórtola	Umbrá	Sabbia
	3	R	O	S	1	2
160 x 70	PANV1F2LDI16970-	1.713 €			1.713 €	
170 x 70	PANV1F2LDI17970-					
170 x 75	PANV1F2LDI17975-					
180 x 80	PANV1F2LDI18980-					
180 x 100	PANV1F2LDI18910-					
190 x 90	PANV1F2LDI19990-					

Medidas	CODIGO - Seleccionar número de paneles 	Selección acabado paneles Seleção acabamento paineis				
		ARCILLA			MDI	
	4 paneles/painels	Ceniza	Polvo	Tórtola	Umbrá	Sabbia
	4	R	O	S	1	2
160 x 70	PANV2F2LDI16970-	2.550 €			2.550 €	
170 x 70	PANV2F2LDI17970-					
170 x 75	PANV2F2LDI17975-					
180 x 80	PANV2F2LDI18980-					
180 x 100	PANV2F2LDI18910-					
190 x 90	PANV2F2LDI19990-					

Acabado FRAME	Selección de paneles acabado FRAME											
	FRAME		MADERA				ARCILLA			MDI		
	Blanco mate	Negro mate	Blanco mate*	Blanco rayado	Grain	Burlington	Dolomite	Ceniza	Polvo	Tórtola	Umbrá	Sabbia
	U	H	U	I	M	N	X	R	O	S	1	2
			677 €				1.038 €			1.038 €		

Acabado FRAME	Selección de paneles acabado FRAME											
	FRAME		MADERA				ARCILLA			MDI		
	Blanco mate	Negro mate	Blanco mate*	Blanco rayado	Grain	Burlington	Dolomite	Ceniza	Polvo	Tórtola	Umbrá	Sabbia
	U	H	U	I	M	N	X	R	O	S	1	2
			838 €				1.437 €			1.437 €		

Acabado FRAME	Selección de paneles acabado FRAME											
	FRAME		MADERA				ARCILLA			MDI		
	Blanco mate	Negro mate	Blanco mate*	Blanco rayado	Grain	Burlington	Dolomite	Ceniza	Polvo	Tórtola	Umbrá	Sabbia
	U	H	U	I	M	N	X	R	O	S	1	2
			1.038 €				1.874 €			1.874 €		

Acabado FRAME	Selección de paneles acabado FRAME											
	FRAME		MADERA				ARCILLA			MDI		
	Blanco mate	Negro mate	Blanco mate*	Blanco rayado	Grain	Burlington	Dolomite	Ceniza	Polvo	Tórtola	Umbrá	Sabbia
	U	H	U	I	M	N	X	R	O	S	1	2
			1.674 €				2.872 €			2.872 €		

FRAME SOLO EN PANEL FRONTAL
 * EL ACABADO BLANCO MATE PANEL SÓLO ESTÁ DISPONIBLE CON MARCO NEGRO MATE



DIVINA

BAÑERA BLANCO MATE/BRANCO MATE CON PANELES BURLINGTON + MARCO DE ALUMINIO NEGRO MATE



BAÑERA BLANCO MATE/BRANCO MATE CON PANEL BLANCO MATE/BRANCO MATE



BAÑERA BLANCO MATE / BRANCO MATE CON PANEL ARCILLA CENIZA

STILE C | ACABADOS PANELES

PANEL



Blanco brillo
Branco brilhante

Blanco mate
Branco mate

PANEL ARCILLA

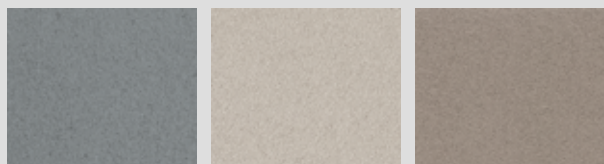

Ceniza

Polvo

Tórtola

PANEL ACABADO MADERA

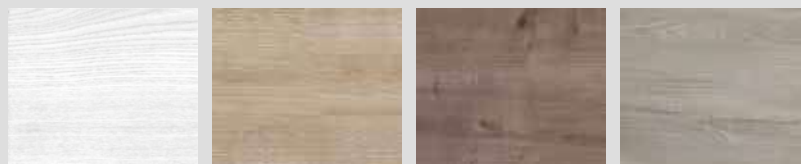

Blanco rayado

Grain

Burlington

Dolomite

STILE C | EQUIPAMIENTO Y FUNCIONES (disponibles según versión)

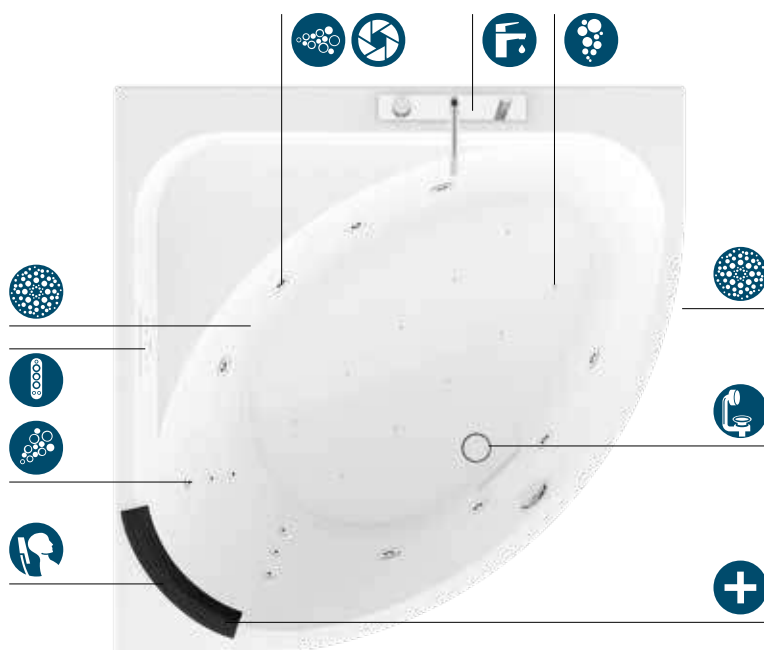

Masaje Airpool mediante jets de aire con regulación manual on/off o programa secuencial, para una **estimulación celular eficaz.**

Massagem Airpool através de jets de ar com regulação manual on/off ou programa sequencial, para uma **estimulação celular eficaz.**

Masaje corporal Whirlpool aire/agua con regulación de tiempo e intensidad manual o automática para satisfacer cualquier necesidad de bienestar.

Massagem corpo Whirlpool ar/agua com regulação de tempo e intensidade manual ou automática.

8 posiciones cromáticas a partir del sistema CROMOLIGHT para activar la mente y sentir la emoción del espíritu.

8 posições cromáticas a partir do sistema Cromolight para activar a mente e sentir a emoção do espírito.

Masaje dorsal hidromasaje aire/agua.

Massagem de hidromassagem nas costas ar/água.

Natural air

Panel electrónico con funciones de Hidro-secuencia
Panel electrónico com funções de Hidro-sequência

Reposa-cabezas
Apoia-cabeças

Grifería al borde de la bañera
Torneira no rebordo da banheira

Columna de desagüe
Coluna de desagüe

Desinfección
Desinfecção

Designed by Marco Pellici



BAÑERA BLANCO BRILLO CON PANEL DOLOMITE



Panel de control capacitivo
Panel de controlo capacitivo



Repisa
Prateleira



Nuevo mando de desague
Novo comando de esgoto



Nuevos jets de hidromasaje
Novos jactos de hidromassagem

STILE

STILE C

STILE C

BAÑERA SEMICIRCULAR ANGULAR, SIMETRICA
BANHEIRA SEMICIRCULAR ANGULAR, SIMETRICA

Medidas			litros	Código	Selección columna de desagüe, grifería y acabado de la bañera Seleção de valvulas/enchimento + acabamento banheira						selección estructura / paneles seleção opções / paineis	
Cm	H	Lt.			Columna de desagüe sin grifería Blanco brillo Branco brilho		Columna de desagüe con sistema de llenado Blanco mate Branco mate		Columna de desagüe con grifería Blanco mate Branco mate		sin paneles sem paineis	
STANDAR PARA EMPOTRAR STANDAR PARA EMBUTIR												
				0-A	0-U	1-A	1-U	2-A	2-U	0K		
135 X 135	63	310	STI1135135	1.155 €	+ 1.259 €	1.230 €	+ 1.333 €	+ 1.818 €	+ 1.922 €			
STANDARD CON SOPORTE STANDARD COM SUPORTE												
				0-A	0-U	1-A	1-U	2-A	2-U	0K	* ver tabla seleccionar número de paneles + acabado	
135 X 135	63	310	STI2135135	1.541 €	+ 1.645 €	1.615 €	+ 1.719 €	+ 2.204 €	+ 2.308 €			
HYDRO AIR												
				0-A	0-U	1-A	1-U	2-A	2-U	0K	* ver tabla seleccionar número de paneles + acabado	
135 X 135	63	310	STIY1351350	2.688 €	+ 2.792 €	2.762 €	+ 2.866 €	+ 3.351 €	+ 3.455 €			
WHIRLPOOL												
				0-A	0-U	1-A	1-U	2-A	2-U	0K	* ver tabla seleccionar número de paneles + acabado	
135 X 135	63	310	STI51351350	2.914 €	+ 3.018 €	2.988 €	+ 3.092 €	+ 3.576 €	+ 3.680 €			
HYDRO PLUS												
				0-A	0-U	1-A	1-U	2-A	2-U	0K	* ver tabla seleccionar número de paneles + acabado	
135 X 135	63	310	STI41351350	3.766 €	+ 3.870 €	3.840 €	+ 3.944 €	+ 4.429 €	+ 4.533 €			
NATURAL AIR												
				0-A	0-U	1-A	1-U	2-A	2-U	0K	* ver tabla seleccionar número de paneles + acabado	
135 X 135	63	310	STIN1351350	4.785 €	+ 4.889 €	4.859 €	+ 4.963 €	+ 5.447 €	+ 5.551 €			
NATURAL AIR + WHIRLPOOL												
				0-A	0-U	1-A	1-U	2-A	2-U	0K	* ver tabla seleccionar número de paneles + acabado	
135 X 135	63	310	STIP1351350	5.541 €	+ 5.645 €	5.615 €	+ 5.719 €	+ 6.203 €	+ 6.307 €			



BAÑERA BLANCO BRILLO CON PANEL ARCILLA POLVO

	Selección acabado paneles/Seleção acabamento paineis								
	LAMINADO		ACABADO MADERA				ARCILLA		
	1 panel - Acabado bañera blanco brillo 1 painel - Acabamentos branco brilhante	1 panel - Acabado bañera blanco mate 1 painel - Acabamentos branco mate	Blanco rayado	Grain	Burlington	Dolomite	Ceniza	Polvo	Tórtola
	1A	1U	1I	1M	1N	1X	1R	1O	1S
	+ 479 €		+ 847 €				+ 1.161 €		

Construcción del código de la bañera sin paneles **Código** + Selección de desagüe/llenado+acabado bañera **Seleção de valvulas/enchimento + acabamento banheira** + selección estructura sin paneles = Código completo del producto **Código completo do produto**

Construcción del código de la bañera con paneles **Código** + Selección de desagüe/llenado+acabado bañera **Seleção de valvulas/enchimento + acabamento banheira** + selección estructura con paneles (laminado o acabado madera) = Código completo del producto **Código completo do produto**

COLORES ESPECIALES BAJO PEDIDO PARA PANELES DE ARCILLA / CORES ESPECIAIS A PEDIDO PARA PAINÉIS DE ARGILA

				PANELES	Precio / Preço
Cipria	Tegola	Alga	Senape	1 panel	+133 €



GRIFERÍA COLOR NEGRO MATE BAJO PEDIDO: + 133 €



BAÑERA BLANCO MATE / BRANCO MATE CON PANELES DOLOMITE



BAÑERA BLANCO MATE/BRANCO MATE CON PANEL ARCILLA POLVO+MARCO NEGRO MATE

STILE | ACABADOS PANELES

LAMINADO

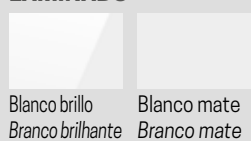

ACABADO MADERA

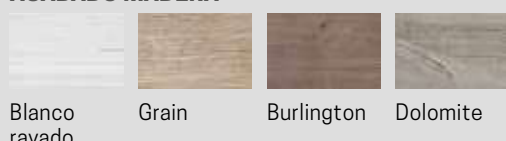

ARCILLA

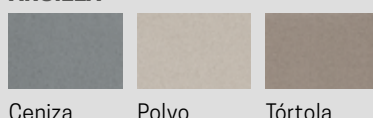

MDI

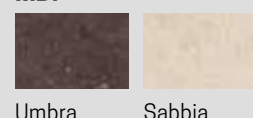

MARCO DE ALUMINIO NEGRO MATE

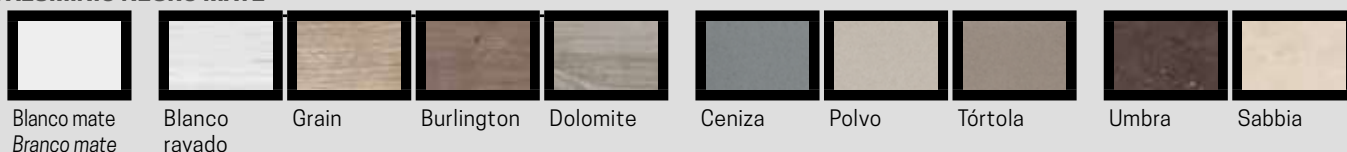

MARCO DE ALUMINIO BLANCO MATE / BRANCO MATE

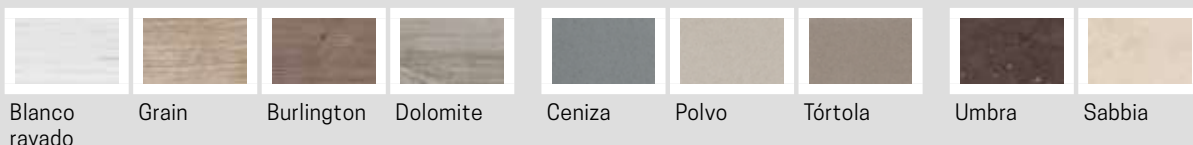

STILE | EQUIPAMIENTO Y FUNCIONES (disponibles según versión)

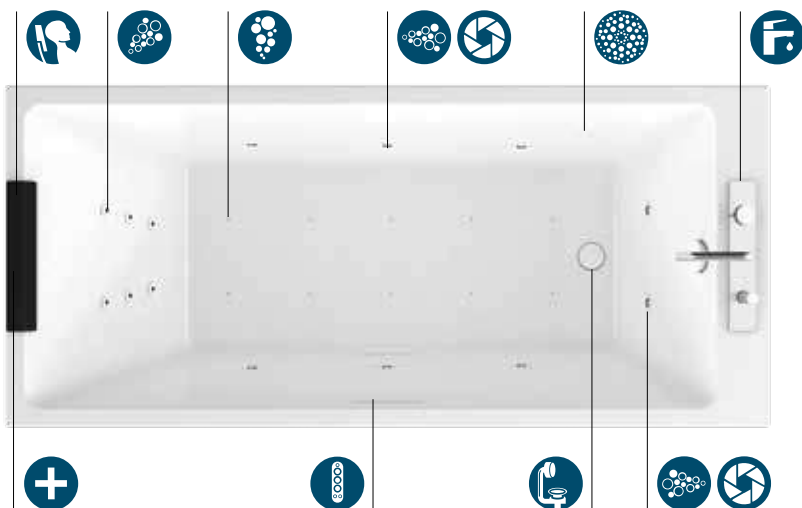

Masaje Airpool mediante jets de aire con regulación manual on/off o programa secuencial, para una **estimulación celular eficaz.**

Massagem Airpool através de jets de ar com regulação manual on/off ou programa sequencial, para uma **estimulação celular eficaz.**

Masaje corporal Whirlpool aire/agua con regulación de tiempo e intensidad manual o automática para satisfacer cualquier necesidad de bienestar.

Massagem corpo Whirlpool ar/agua com regulação de tempo e intensidade manual ou automática.

8 posiciones cromáticas a partir del sistema CROMOLIGHT para activar la mente y sentir la emoción del espíritu.

8 posições cromáticas a partir do sistema Cromolight para activar a mente e sentir a emoção do espírito.

Masaje dorsal hidromasaje aire/agua.

Massagem de hidromassagem nas costas ar/água.

Natural air

Panel electrónico con funciones de Hidro-secuencia
Panel electrónico com funções de Hidro-sequência

Reposa-cabezas
Apoia-cabeças

Grifería al borde de la bañera
Torneira no rebordo da banheira

Columna de desagüe
Coluna de desagüe

Desinfección
Desinfecção

Designed by Marco Pellici



BAÑERA BLANCO MATE/BRANCO MATE CON PANEL MDI SABBIA+MARCO NEGRO MATE



Panel de control capacitivo
Painel de controlo capacitivo



Repisa
Prateleira



Nuevo mando de desague
Novo comando de esgoto



Nuevos jets de hidromasaje
Novos jactos de hidromassagem

STILE

STILE

STILE

BAÑERA RECTANGULAR BANHEIRA RECTANGULAR

Medidas			litros	Código	Selección columna de desagüe, grifería y acabado de la bañera Seleção de valvulas/enchimento + acabamento banheira						Selección Estructura / paneles Seleção Opções / painéis	
Cm	H	Lt.			Columna de desagüe sin grifería		Columna de desagüe con sistema de llenado		Columna de desagüe con grifería		sin paneles sem painéis	con paneles com painéis
					Blanco brillo Branco brilho	Blanco mate Branco mate	Blanco brillo Branco brilho	Blanco mate Branco mate	Blanco brillo Branco brilho	Blanco mate Branco mate		

STANDAR PARA EMPOTRAR STANDAR PARA EMBUTIR

				0-A	0-U	1-A	1-U	2-A	2-U	0K	
170 x 70	63	250	STI117970								
170 x 75	63	280	STI117975	863 €	967 €	937 €	1.041 €	1.525 €	1.629 €		
180 x 80	63	330	STI118980								
180 x 110	63	500	STI118911								
190 x 90	63	410	STI119990	1.155 €	1.259 €	1.230 €	1.333 €	1.818 €	1.922 €		

STANDARD CON SOPORTE STANDARD COM SUPORTE

				0-A	0-U	1-A	1-U	2-A	2-U	0K	* ver tabla seleccionar número de paneles + acabado
170 x 70	63	250	STI217970								
170 x 75	63	280	STI217975	1.101 €	1.205 €	1.176 €	1.279 €	1.764 €	1.868 €		
180 x 80	63	330	STI218980								
180 x 110	63	500	STI218911								
190 x 90	63	410	STI219990	1.380 €	1.483 €	1.454 €	1.558 €	2.043 €	2.147 €		

HYDRO AIR

				0-A	0-U	1-A	1-U	2-A	2-U	0K	* ver tabla seleccionar número de paneles + acabado
170 x 70	63	250	STIY179700								
170 x 75	63	280	STIY179750	2.355 €	2.459 €	2.430 €	2.533 €	3.018 €	3.122 €		
180 x 80	63	330	STIY189800								
180 x 110	63	500	STIY189110								
190 x 90	63	410	STIY199900	2.615 €	2.730 €	2.689 €	2.793 €	3.278 €	3.381 €		

WHIRLPOOL

				0-A	0-U	1-A	1-U	2-A	2-U	0K	* ver tabla seleccionar número de paneles + acabado
170 x 70	63	250	STI5179700								
170 x 75	63	280	STI5179750	2.580 €	2.684 €	2.654 €	2.758 €	3.243 €	3.346 €		
180 x 80	63	330	STI5189800								
180 x 110	63	500	STI5189110								
190 x 90	63	410	STI5199900	2.839 €	2.953 €	2.913 €	3.017 €	3.501 €	3.605 €		

WHIRLPOOL+DESINFECCIÓN+LIGHT

				0-A	0-U	1-A	1-U	2-A	2-U	0K	* ver tabla seleccionar número de paneles + acabado
170 x 70	63	250	STI3179700								
170 x 75	63	280	STI3179750	3.432 €	3.536 €	3.506 €	3.610 €	4.095 €	4.199 €		
180 x 80	63	330	STI3189800								
180 x 110	63	500	STI3189110								
190 x 90	63	410	STI3199900	3.777 €	3.889 €	3.851 €	3.955 €	4.439 €	4.543 €		

Medidas			Código	Selección columna de desagüe, grifería y acabado de la bañera / Seleção de valvulas/enchimento + acabamento banheira						Selección Estructura / paneles Seleção Opções / paineis	
Cm	H	Lt.		Columna de desagüe sin grifería		Columna de desagüe con sistema de llenado		Columna de desagüe con grifería		sin paneles sem paineis	con paneles com paineis
			Blanco brillo Branco brilho	Blanco mate Branco mate	Blanco brillo Branco brilho	Blanco mate Branco mate	Blanco brillo Branco brilho	Blanco mate Branco mate			
HYDRO PLUS											
				0-A	0-U	1-A	1-U	2-A	2-U	0K	* ver tabla seleccionar número de paneles + acabado
170 x 70	63	250	STI4179700	4.450 €	4.554 €	4.524 €	4.628 €	5.112 €	5.216 €		
170 x 75	63	280	STI4179750								
180 x 80	63	330	STI4189800								
180 x 110	63	500	STI4189110	4.717 €	4.827 €	4.791 €	4.895 €	5.380 €	5.483 €		
190 x 90	63	410	STI4199900								
NATURAL AIR + WHIRLPOOL											
				0-A	0-U	1-A	1-U	2-A	2-U	0K	* ver tabla seleccionar número de paneles + acabado
170 x 70	63	250	STIP179700	5.207 €	5.311 €	5.281 €	5.385 €	5.869 €	5.973 €		
170 x 75	63	280	STIP179750								
180 x 80	63	330	STIP189800								
180 x 110	63	500	STIP189110	5.467 €	5.576 €	5.542 €	5.646 €	6.130 €	6.234 €		
190 x 90	63	410	STIP199900								

Seleccionar número de paneles				Selección acabado paneles/Seleção acabamento paineis						
				Laminado		Acabado madera				
1 panel/Painel	2 paneles/painéis	3 paneles/painéis	4 paneles/painéis	Blanco brillo Branco brilhante	Blanco mate Branco mate	Blanco rayado	Grain	Burlington	Dolomite	
1	2	3	4	A	U	I	M	N	X	
	-	-	-	+ 329 €	+ 349 €	+ 376 €				
-		-	-	+ 479 €	+ 507 €	+ 546 €				
-	-		-	+ 670 €	+ 704 €	+ 758 €				
-	-	-		+ 956 €	+ 1.011 €	+ 1.092 €				

Construcción del código de la bañera sin paneles **Código** + Selección de desagüe/llenado+acabado bañera / Seleção de valvulas/enchimento + acabamento banheira + selección estructura sin paneles = Código completo del producto / Código completo do produto

Construcción del código de la bañera con paneles **Código** + Selección de desagüe/llenado+acabado bañera / Seleção de valvulas/enchimento + acabamento banheira + selección estructura con paneles (laminado o acabado madera) = Código completo del producto / Código completo do produto



GRIFERÍA COLOR NEGRO MATE BAJO PEDIDO: + 133 €

PARA LA VERSIÓN CON PANELES EN ACABADO ARCILLA / FRAME PEDIR: 1 CÓDIGO BAÑERA SOLO ESTRUCTURA + 1 CÓDIGO PANEL ARCILLA / FRAME (ADJUNTO)

Medidas	CODIGO - Seleccionar número de paneles 	Selección acabado paneles Seleção acabamento paineis					Acabado FRAME	Selección de paneles acabado FRAME												
		ARCILLA						MDI	FRAME	MADERA					ARCILLA					MDI
		Ceniza	Polvo	Tórtola	Umbr	Sabbia		Blanco mate	Negro mate	Blanco mate*	Blanco rayado	Grain	Burlington	Dolo-mite	Ceniza	Polvo	Tórtola	Umbr	Sabbia	
		R	O	S	1	2		U	H	U	I	M	N	X	R	O	S	1	2	
170 x 70; 170 x 75	PANV1FDI179-							718 €					1.100 €					1.100 €		
180 x 80; 180 x 110	PANV1FDI189-	930 €											1.100 €					1.100 €		
190 x 90	PANV1FDI199-																			
2 paneles/painels																				
		Ceniza	Polvo	Tórtola	Umbr	Sabbia		Blanco mate	Negro mate	Blanco mate*	Blanco rayado	Grain	Burlington	Dolo-mite	Ceniza	Polvo	Tórtola	Umbr	Sabbia	
		R	O	S	1	2		U	H	U	I	M	N	X	R	O	S	1	2	
170 x 70	PANV1F1LDI17970-							888 €					1.523 €					1.523 €		
170 x 75	PANV1F1LDI17975-	1.352 €											1.523 €					1.523 €		
180 x 80	PANV1F1LDI18980-	1.352 €																		
180 x 110	PANV1F1LDI18911-																			
190 x 90	PANV1F1LDI19990-																			
3 paneles/painels																				
		Ceniza	Polvo	Tórtola	Umbr	Sabbia		Blanco mate	Negro mate	Blanco mate*	Blanco rayado	Grain	Burlington	Dolo-mite	Ceniza	Polvo	Tórtola	Umbr	Sabbia	
		R	O	S	1	2		U	H	U	I	M	N	X	R	O	S	1	2	
170 x 70	PANV1F2LDI17970-							1.100 €					1.986 €					1.986 €		
170 x 75	PANV1F2LDI17975-	1.816 €											1.986 €					1.986 €		
180 x 80	PANV1F2LDI18980-	1.816 €																		
180 x 110	PANV1F2LDI18911-																			
190 x 90	PANV1F2LDI19990-																			
4 paneles/painels																				
		Ceniza	Polvo	Tórtola	Umbr	Sabbia		Blanco mate	Negro mate	Blanco mate*	Blanco rayado	Grain	Burlington	Dolo-mite	Ceniza	Polvo	Tórtola	Umbr	Sabbia	
		R	O	S	1	2		U	H	U	I	M	N	X	R	O	S	1	2	
170 x 70	PANV2F2LDI17970-							1.774 €					3.044 €					3.044 €		
170 x 75	PANV2F2LDI17975-	2.703 €											3.044 €					3.044 €		
180 x 80	PANV2F2LDI18980-	2.703 €																		
180 x 110	PANV2F2LDI18911-																			
190 x 90	PANV2F2LDI19990-																			





EL MARCO DE ALUMINIO FRAME SÓLO ESTÁ DISPONIBLE EN LOS PANELES LATERALES

* EL ACABADO BLANCO MATE DE LOS PANELES SÓLO ESTÁ DISPONIBLE CON MARCO FRAME NEGRO MATE

Construcción del código: **Código** + **Acabado paneles** = Código final del producto

Construcción del código: **Código** + **Acabado Frame** + **Acabado paneles** = Código final del producto

COLORES ESPECIALES BAJO PEDIDO PARA PANELES ACABADO ARCILLA Y PARA FRAME COMBINADO CON PANELES ACABADO ARCILLA

				PANELES	Precio / Preço
Cipria	Tegola	Alga	Senape	1-2 paneles	+133 €
				3-4 paneles	+266 €



MEDIDA 170X75



MEDIDA 180X110

STILE



BAÑERA BLANCO MATE/BRANCO MATE CON PANEL BLANCO MATE/BRANCO MATE



BAÑERA BLANCO MATE/BRANCO MATE CON PANEL BLANCO MATE/BRANCO MATE Y BORDE DOLOMITE

SENSE DUAL | ACABADOS PANELES Y BORDE BAÑERA

PANELES



Blanco brillo
Branco brilhante

Blanco mate
Branco mate

PANELES ACABADO MADERA

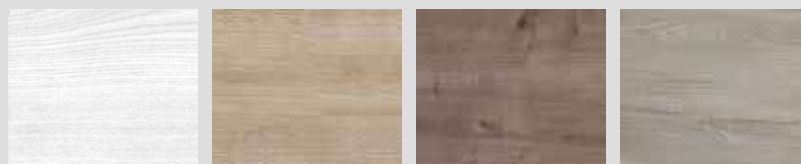

Blanco rayado

Grain

Burlington

Dolomite

BORDE BAÑERA / BORDO BANHEIRA LAMINADO



Blanco brillo
Branco brilhante

Blanco mate
Branco mate

BORDE BAÑERA / BORDO BANHEIRA ACABADO MADERA



Blanco rayado

Grain

Burlington

Dolomite

SENSE DUAL | EQUIPAMIENTO Y FUNCIONES (disponibles según versión)

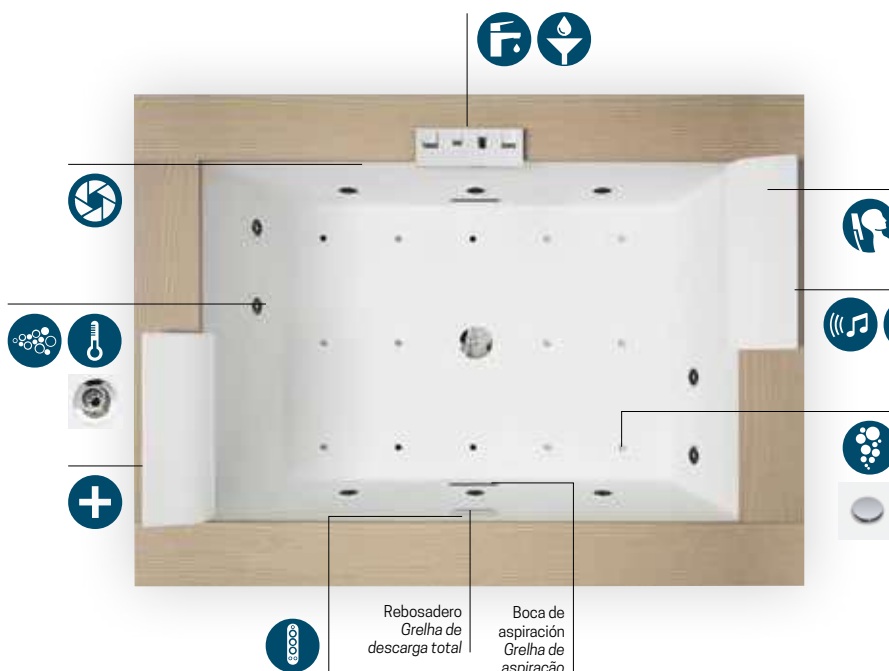

Rebosadero
Grelha de
descarga total

Boca de
aspiración
Grelha de
aspiração

- Masaje Airpool** mediante jets de aire con regulación manual on/off o programa secuencial, para una **estimulación celular eficaz**.
- Massagem Airpool** através de jets de ar com regulação manual on/off ou programa sequencial, para uma **estimulação celular eficaz**.
- Masaje corporal Whirlpool** aire/agua con regulación de tiempo e intensidad manual o automática para satisfacer cualquier necesidad de bienestar.
- Massagem corpo Whirlpool** ar/agua com regulação de tempo e intensidade manual ou automática.
- Encendido táctil
Ligação Soft touch.
- 2 Reposacabezas blancos de auténtica piel
- Grifería al borde de la bañera + Tubo de desagüe anti-gotas
Torneira no rebordo da banheira + Tubo de descarga salvagotas
- Programa 4 estaciones Cromolight**. Una sinfonía de luces y colores para intensificar las emociones.
Programa 4 estações Cromolight. Uma sinfonia de luzes e cores para intensificar as emoções.
- Re-calentador de agua
Aquecimento da água
- Desinfección
Desinfecção
- Radio RDS Stereo con 4 altavoces y Bluetooth
Radio RDS Stereo com 4 colunas de som e Bluetooth



BAÑERA BLANCO MATE/BRANCO MATE CON PANEL GRAIN Y GORDE BLANCO MATE/BRANCO MATE



2 Reposacabezas blancos de auténtica piel



Radio RDS Stereo con 4 altavoces y Bluetooth
Radio RDS Stereo com 4 colunas de som e Bluetooth



Re-calentador de agua
Aquecimento da água



Chromolight integrado para estimular cuerpo y emociones.
Chromolight integrado para estimular o corpo e as emoções.

SENSE



SENSE DUAL

SENSE DUAL

BAÑERA RECTANGULAR PARA DOS PERSONAS

Medidas	litros	Código	Selección acabado bañera seleção acabamento paineis		Selección acabado borde bañera Seleção de inclui para bordo banheira					
					Laminado		Acabado madera Acabamento madeira			
Cm	H	Lt.	Blanco brillo Branco brilho	Blanco mate Branco mate	Blanco brillo Branco brilho	Blanco mate Branco mate	Blanco rayado Branco listrado	Grain	Burlington	Dolomite

ESSENTIAL														
					-A0	-U0	A	U	I	M	N	X		
	193X140	64	430	SE2190142	7.170 €	7.275 €								

HYDRO PLUS																						
					-A0	-U0	A	U	I	M	N	X										
	193X140	64	430	SE719014T7	11.487 €	11.591 €																

PANEL FRONTAL 193 CM												
							A	U	I	M	N	X
	193 x 140			PANVFSE194-	628 €	628 €	628 €	628 €	628 €	628 €	628 €	628 €

PANEL FRONTAL 193 CM: PANEL LATERAL 140 CM												
							A	U	I	M	N	X
	193 x 140			PANVFLSE194-	1.044 €	1.044 €	1.044 €	1.044 €	1.044 €	1.044 €	1.044 €	1.044 €

PANEL FRONTAL 193 CM; 2 PANELES LATERALES 140 CM												
							A	U	I	M	N	X
	193 x 140			PANVF2LSE194-	1.392 €	1.392 €	1.392 €	1.392 €	1.392 €	1.392 €	1.392 €	1.392 €

2 PANNELI FRONTALI 193 CM; 2 PANNELI LATERALI 140 CM												
							A	U	I	M	N	X
	193 x 140			PANVFLSE194C-	2.087 €	2.087 €	2.087 €	2.087 €	2.087 €	2.087 €	2.087 €	2.087 €

PARA TODAS LAS OPCIONES VER PÁGINA 536,537







BAÑERA BLANCO MATE/BRANCO MATE CON PANELES BLANCO RAYADO



BAÑERA BLANCO MATE/BRANCO MATE CON PANELES BURLINGTON

SENSE 2.0 | ACABADOS PANELES

LAMINADO



Blanco brillo
Branco brilhante

Blanco mate
Branco mate

ACABADO MADERA

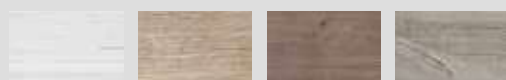

Blanco rayado

Grain

Burlington

Dolomite

ARCILLA

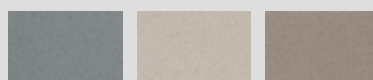

Ceniza

Polvo

Tórtola

MDI



Umbrá

Sabbia

MARCO DE ALUMINIO NEGRO MATE



Blanco mate
Branco mate

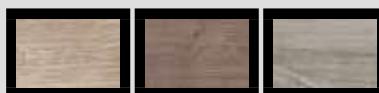

Grain

Burlington

Dolomite

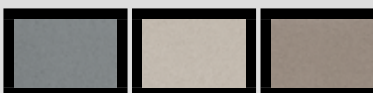

Ceniza

Polvo

Tórtola

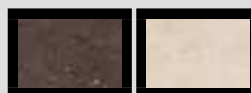

Umbrá

Sabbia

MARCO DE ALUMINIO BLANCO MATE / BRANCO MATE



Grain

Burlington

Dolomite

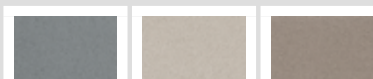

Ceniza

Polvo

Tórtola



Umbrá

Sabbia

SENSE 3-4 2.0 | EQUIPAMIENTO Y FUNCIONES (disponibles según versión)

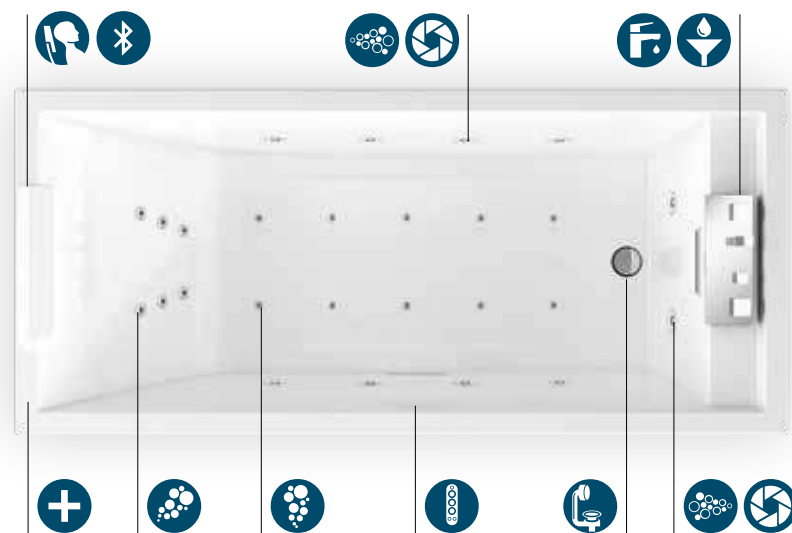

Masaje Airpool mediante jets de aire con regulación manual on/off o programa secuencial, para una **estimulación celular eficaz**.

Massagem Airpool através de jets de ar com regulação manual on/off ou programa sequencial, para uma **estimulação celular eficaz**.

Masaje corporal Whirlpool aire/agua con regulación de tiempo e intensidad manual o automática para satisfacer cualquier necesidad de bienestar.

Massagem corpo Whirlpool ar/água com regulação de tempo e intensidade manual ou automática.

8 posiciones cromáticas a partir del sistema CROMOLIGHT para activar la mente y sentir la emoción del espíritu.

8 posições cromáticas a partir do sistema Cromolight para activar a mente e sentir a emoção do espírito.

Masaje dorsal hidromasaje aire/agua.
Massagem de hidromassagem nas costas ar/água.

Panel electrónico con funciones de Hidro-secuencia
Panel electrónico com funções de Hidro-sequência

Reposa-cabezas
Apoia-cabeças

Grifería al borde de la bañera + Tubo de desagüe anti-gotas
Torneira no rebordo da banheira + Tubo de descarga salvagotas

Columna de desagüe
Coluna de desagüe

Desinfección
Desinfecção



BAÑERA BLANCO MATE / BRANCO MATE CON PANEL ARCILLA POLVO

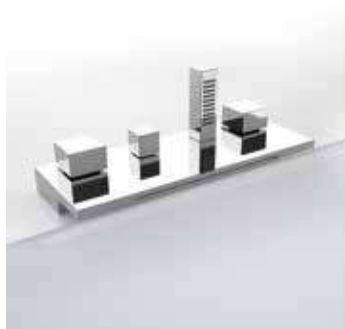

Grifería
Torneira



Jet de hidromasaje cromado
Jactos de hidromassagem
cromado



Panel de control capacitivo
Painel de controlo capacitivo



Reposacabezas
Apoia-cabeças

SENSE

SENSE 2.0

SENSE 3 2.0



SENSE 3 2.0

BAÑERA RECTANGULAR
BANHEIRA RECTANGULAR

Medidas			litros	Código	Selección columna de desagüe, grifería y acabado de la bañera Seleção de valvulas/enchimento + acabamento banheira				Selección Estructura / paneles Seleção Opções / painels	
Cm	H	Lt.			 Columna de desagüe sin grifería Blanco brillo Branco brilho		 Columna de desagüe con grifería Blanco mate Branco mate		 solo estructura só estrutura	 con paneles com painels

STANDAR PARA EMPOTRAR STANDAR PARA EMBUTIR					0-A	0-U	2-A	2-U	0K	
170 X 70	63	205	S23117970							
170 X 75	63	225	S23117975	1.207 €	1.311 €	2.362 €	2.465 €			
180 X 80	63	250	S23118980							
190 X 80	63	265	S23119980							

STANDARD CON SOPORTE STANDARD COM SUPORTE					0-A	0-U	2-A	2-U	0K	 * ver tabla seleccionar número de paneles + acabado
170 X 70	63	205	S23217970							
170 X 75	63	225	S23217975	1.445 €	1.548 €	2.599 €	2.702 €			
180 X 80	63	250	S23218980							
190 X 80	63	265	S23219980							

HYDRO AIR					0-A	0-U	2-A	2-U	0K	 * ver tabla seleccionar número de paneles + acabado
170 X 70	63	205	S23Y179700							
170 X 75	63	225	S23Y179750	2.518 €	2.621 €	3.672 €	3.776 €			
180 X 80	63	250	S23Y189800							
190 X 80	63	265	S23Y199800							

WHIRLPOOL+DESINFECCIÓN					0-A	0-U	2-A	2-U	0K	 * ver tabla seleccionar número de paneles + acabado
170 X 70	63	205	S235179700							
170 X 75	63	225	S235179750	3.279 €	3.381 €	4.433 €	4.536 €			
180 X 80	63	250	S235189800							
190 X 80	63	265	S235199800							

WHIRLPOOL+DESINFECCIÓN+LIGHT					0-A	0-U	2-A	2-U	0K	 * ver tabla seleccionar número de paneles + acabado
170 X 70	63	205	S233179700							
170 X 75	63	225	S233179750	3.975 €	4.079 €	5.129 €	5.233 €			
180 X 80	63	250	S233189800							
190 X 80	63	265	S233199800							

HYDRO PLUS					0-A	0-U	2-A	2-U	0K	 * ver tabla seleccionar número de paneles + acabado
170 X 70	63	205	S234179700							
170 X 75	63	225	S234179750	5.348 €	5.452 €	6.502 €	6.606 €			
180 X 80	63	250	S234189800							
190 X 80	63	265	S234199800							

WHIRLPOOL+NATURAL AIR					0-A	0-U	2-A	2-U	0K	 * ver tabla seleccionar número de paneles + acabado
170 X 70	63	205	S23P179700							
170 X 75	63	225	S23P179750	5.751 €	5.854 €	6.905 €	7.009 €			
180 X 80	63	250	S23P189800							
190 X 80	63	265	S23P199800							



Seleccionar número de paneles				Selección acabado paneles/Seleção acabamento painéis					
				Laminado		Acabado madera			
1 panel/Painel	2 paneles/painéis	3 paneles/painéis	4 paneles/painéis	Blanco brillo Branco brilhante	Blanco mate Branco mate	Blanco rayado	Grain	Burlington	Dolomite
1	2	3	4	A	U	I	M	N	X
	-	-	-	+ 329 €	+ 349 €	+ 376 €			
-		-	-	+ 479 €	+ 507 €	+ 546 €			
-	-		-	+ 670 €	+ 704 €	+ 758 €			
-	-	-		+ 956 €	+ 1.011 €	+ 1.092 €			

Construcción del código de la bañera sin paneles **Código** + Selección de desagüe/llenado+acabado bañera
Seleção de valvulas/enchimento + acabamento banheira + selección estructura sin paneles = Código completo del producto
Código completo do produto

Construcción del código de la bañera con paneles **Código** + Selección de desagüe/llenado+acabado bañera
Seleção de valvulas/enchimento + acabamento banheira + selección estructura con paneles
(laminado o acabado madera) = Código completo del producto
Código completo do produto

SENSE

SENSE 4 2.0



SENSE 4 2.0

BAÑERA RECTANGULAR
BANHEIRA RECTANGULAR

Medidas			litros	Código	Selección columna de desagüe, grifería y acabado de la bañera Seleção de valvulas/enchimento + acabamento banheira				Selección Estructura / paneles Seleção Opções / painels	
Cm	H	Lt.			 Columna de desagüe sin grifería Blanco brillo Branco brilho		 Columna de desagüe con grifería Blanco mate Branco mate		 solo estructura só estrutura	 con paneles com painels

STANDAR PARA EMPOTRAR STANDAR PARA EMBUTIR					0-A	0-U	2-A	2-U	0K	
170 X 70	63	215	S24117970							
170 X 75	63	235	S24117975	1.065 €	1.169 €	2.220 €	2.324 €			
180 X 80	63	265	S24118980							
190 X 80	63	280	S24119980							

STANDARD CON SOPORTE STANDARD COM SUPORTE					0-A	0-U	2-A	2-U	0K	 * ver tabla seleccionar número de paneles + acabado
170 X 70	63	215	S24217970							
170 X 75	63	235	S24217975	1.303 €	1.407 €	2.457 €	2.560 €			
180 X 80	63	265	S24218980							
190 X 80	63	280	S24219980							

HYDRO AIR					0-A	0-U	2-A	2-U	0K	 * ver tabla seleccionar número de paneles + acabado
170 X 70	63	215	S24Y179700							
170 X 75	63	235	S24Y179750	2.374 €	2.478 €	3.529 €	3.633 €			
180 X 80	63	265	S24Y189800							
190 X 80	63	280	S24Y199800							

WHIRLPOOL+DESINFECCIÓN					0-A	0-U	2-A	2-U	0K	 * ver tabla seleccionar número de paneles + acabado
170 X 70	63	215	S245179700							
170 X 75	63	235	S245179750	3.137 €	3.240 €	4.291 €	4.394 €			
180 X 80	63	265	S245189800							
190 X 80	63	280	S245199800							

WHIRLPOOL+DESINFECCIÓN+LIGHT					0-A	0-U	2-A	2-U	0K	 * ver tabla seleccionar número de paneles + acabado
170 X 70	63	215	S243179700							
170 X 75	63	235	S243179750	3.834 €	3.937 €	4.987 €	5.091 €			
180 X 80	63	265	S243189800							
190 X 80	63	280	S243199800							

HYDRO PLUS					0-A	0-U	2-A	2-U	0K	 * ver tabla seleccionar número de paneles + acabado
170 X 70	63	215	S244179700							
170 X 75	63	235	S244179750	5.207 €	5.310 €	6.360 €	6.464 €			
180 X 80	63	265	S244189800							
190 X 80	63	280	S244199800							

WHIRLPOOL+NATURAL AIR					0-A	0-U	2-A	2-U	0K	 * ver tabla seleccionar número de paneles + acabado
170 X 70	63	215	S24P179700							
170 X 75	63	235	S24P179750	5.610 €	5.712 €	6.763 €	6.867 €			
180 X 80	63	265	S24P189800							
190 X 80	63	280	S24P199800							







Seleccionar número de paneles				Selección acabado paneles/Seleção acabamento painéis					
				Laminado		Acabado madera			
1 panel/Painel	2 paneles/painéis	3 paneles/painéis	4 paneles/painéis	Blanco brillo Branco brilhante	Blanco mate Branco mate	Blanco rayado	Grain	Burlington	Dolomite
1	2	3	4	A	U	I	M	N	X
	-	-	-	+ 329 €	+ 349 €	+ 376 €			
-		-	-	+ 479 €	+ 507 €	+ 546 €			
-	-		-	+ 670 €	+ 704 €	+ 758 €			
-	-	-		+ 956 €	+ 1.011 €	+ 1.092 €			

Construcción del código de la bañera sin paneles **Código** + Selección de desagüe/llenado+acabado bañera / Seleção de valvulas/enchimento + acabamento banheira + selección estructura sin paneles = Código completo del producto / Código completo do produto

Construcción del código de la bañera con paneles **Código** + Selección de desagüe/llenado+acabado bañera / Seleção de valvulas/enchimento + acabamento banheira + selección estructura con paneles (laminado o acabado madera) = Código completo del producto / Código completo do produto

PARA LA VERSIÓN CON PANELES EN ACABADO ARCILLA / FRAME PEDIR: 1 CÓDIGO BAÑERA SOLO ESTRUCTURA + 1 CÓDIGO PANEL ARCILLA / FRAME (ADJUNTO)

Medidas	CODIGO - Seleccionar número de paneles 	Selección acabado paneles Seleção acabamento paineis					Acabado FRAME		Selección de paneles acabado FRAME													
		ARCILLA					MDI		FRAME	MADERA					ARCILLA					MDI		
		Ceniza	Polvo	Tórtola	Umbr	Sabbia			Blanco mate	Negro mate	Blanco mate*	Blanco rayado	Grain	Burlington	Dolo-mite	Ceniza	Polvo	Tórtola	Umbr	Sabbia		
		R	O	S	1	2			U	H	U	I	M	N	X	R	O	S	1	2		
170 x 70; 170 x 75	PANV1FDI179-	930 €					930 €		718 €							1.100 €					1.100 €	
180 x 80	PANV1FDI189-	930 €					930 €		718 €							1.100 €					1.100 €	
190 x 80	PANV1FDI199-	930 €					930 €		718 €							1.100 €					1.100 €	
																						
		Ceniza	Polvo	Tórtola	Umbr	Sabbia			Blanco mate	Negro mate	Blanco mate*	Blanco rayado	Grain	Burlington	Dolo-mite	Ceniza	Polvo	Tórtola	Umbr	Sabbia		
		R	O	S	1	2			U	H	U	I	M	N	X	R	O	S	1	2		
170 x 70	PANV1F1LDI17970-	1.352 €					1.352 €		888 €							1.523 €					1.523 €	
170 x 75	PANV1F1LDI17975-	1.352 €					1.352 €		888 €							1.523 €					1.523 €	
180 x 80	PANV1F1LDI18980-	1.352 €					1.352 €		888 €							1.523 €					1.523 €	
190 x 80	PANV1F1LDI19980-	1.352 €					1.352 €		888 €							1.523 €					1.523 €	
																						
		Ceniza	Polvo	Tórtola	Umbr	Sabbia			Blanco mate	Negro mate	Blanco mate*	Blanco rayado	Grain	Burlington	Dolo-mite	Ceniza	Polvo	Tórtola	Umbr	Sabbia		
		R	O	S	1	2			U	H	U	I	M	N	X	R	O	S	1	2		
170 x 70	PANV1F2LDI17970-	1.816 €					1.816 €		1.100 €							1.986 €					1.986 €	
170 x 75	PANV1F2LDI17975-	1.816 €					1.816 €		1.100 €							1.986 €					1.986 €	
180 x 80	PANV1F2LDI18980-	1.816 €					1.816 €		1.100 €							1.986 €					1.986 €	
190 x 80	PANV1F2LDI19980-	1.816 €					1.816 €		1.100 €							1.986 €					1.986 €	
																						
		Ceniza	Polvo	Tórtola	Umbr	Sabbia			Blanco mate	Negro mate	Blanco mate*	Blanco rayado	Grain	Burlington	Dolo-mite	Ceniza	Polvo	Tórtola	Umbr	Sabbia		
		R	O	S	1	2			U	H	U	I	M	N	X	R	O	S	1	2		
170 x 70	PANV2F2LDI17970-	2.703 €					2.703 €		1.774 €							3.044 €					3.044 €	
170 x 75	PANV2F2LDI17975-	2.703 €					2.703 €		1.774 €							3.044 €					3.044 €	
180 x 80	PANV2F2LDI18980-	2.703 €					2.703 €		1.774 €							3.044 €					3.044 €	
190 x 80	PANV2F2LDI19980-	2.703 €					2.703 €		1.774 €							3.044 €					3.044 €	





EL MARCO DE ALUMINIO FRAME SÓLO ESTÁ DISPONIBLE EN LOS PANELES LATERALES

* EL ACABADO BLANCO MATE DE LOS PANELES SÓLO ESTÁ DISPONIBLE CON MARCO FRAME NEGRO MATE

Construcción del código: **Código** + **Acabado paneles** = Código final del producto

Construcción del código: **Código** + **Acabado Frame** + **Acabado paneles** = Código final del producto

COLORES ESPECIALES BAJO PEDIDO PARA PANELES ACABADO ARCILLA Y PARA FRAME COMBINADO CON PANELES ACABADO ARCILLA

				PANELES	Precio / Preço
Cipria	Tegola	Alga	Senape	1-2 paneles	+133 €
				3-4 paneles	+266 €



SENSE



BAÑERA BLANCO MATE/BRANCO MATE CON PANELES BLANCO RAYADO



BAÑERA BLANCO MATE/BRANCO MATE CON PANELES DOLOMITE

CALOS | ACABADOS PANELES Y BORDE BAÑERA

PANELES



Blanco brillo
Branco brilhante

Blanco mate
Branco mate

PANELES ACABADO MADERA

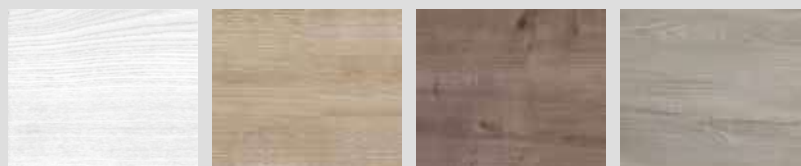

Blanco rayado

Grain

Burlington

Dolomite

CALOS | EQUIPAMIENTO Y FUNCIONES (disponibles según versión)



Masaje Airpool mediante jets de aire con regulación manual on/off o programa secuencial, para una estimulación celular eficaz.

Massagem Airpool através de jets de ar com regulação manual on/off ou programa sequencial, para uma estimulação celular eficaz.



Masaje corporal Whirlpool aire/agua con regulación de tiempo e intensidad manual o automática para satisfacer cualquier necesidad de bienestar.

Massagem corpo Whirlpool ar/agua com regulação de tempo e intensidade manual ou automática.



Panel electrónico con funciones de Hidro-secuencia
Painel electrónico com funções de Hidro-sequência



Reposacabezas
Apoia-cabeças



Grifería al borde de la bañera
Torneira no rebordo da banheira



Columna de desagüe
Coluna de desagüe



Desinfección
Desinfecção



BAÑERA BLANCO BRILLO/BRANCO BRILHANTE CON PANELES BURLINGTON



Panel electrónico con funciones de Hidro-secuencia
Panel electrónico com funções de Hidro-sequência



Fondo liso



El hidromasaje Novellini para una completa expresión de nuestros recursos vitales.
A hidromassagem Novellini para uma completa expressão dos nossos recursos vitais.



Nuevo acabado blanco mate / *branco mate*

CALOS



CALOS

CALOS

BAÑERA RECTANGULAR RECTANGULAR BANHEIRAS

Medidas		litros	Código	Selección columna de desagüe, grifería y acabado de la bañera Seleção de valvulas/enchimento + acabamento banheira				Selección Estructura / paneles Seleção Opções / paineis					
Cm	H	Lt.		solo estructura só estrutura		Columna de desagüe sin grifería		Columna de desagüe con sistema de llenado		Columna de desagüe con grifería		solo estructura só estrutura	con paneles com paineis
				Blanco brillo	Blanco mate	Blanco brillo	Blanco mate	Blanco brillo	Blanco mate	Blanco brillo	Blanco mate		

STANDAR PARA EMPOTRAR STANDAR PARA EMBUTIR				-A	-U	
150 x 70	58	155	C2115070	437 €	540 €	
160 x 70	58	170	C2116070			
170 x 70	58	185	C2117070			
170 x 75	58	200	C2117075			
170 x 80	58	215	C2117080			
180 x 80	58	235	C2118080			

STANDARD CON SOPORTE STANDARD COM SUPORTE						C-A	C-U	E-A	E-U	F-A	F-U	ØK	* ver tabla seleccionar número de paneles + acabado
150 x 70	58	155	C2215070	-	-	806 €	909 €	879 €	983 €	1.408 €	1.511 €		
160 x 70	58	170	C2216070										
170 x 70	58	185	C2217070										
170 x 75	58	200	C2217075										
170 x 80	58	215	C2217080										
180 x 80	58	235	C2218080										

HYDRO CON SOPORTE SIN DESINFECCION COM SUPORTE SEM DESINFECÇÃO						C-A	C-U	E-A	E-U	F-A	F-U	ØK	* ver tabla seleccionar número de paneles + acabado
150 x 70	58	155	C25150700	-	-	1.791 €	1.895 €	1.865 €	1.968 €	2.393 €	2.496 €		
160 x 70	58	170	C25160700										
170 x 70	58	185	C25170700										
170 x 75	58	200	C25170750										
170 x 80	58	215	C25170800										
180 x 80	58	235	C25180800										

HYDRO CON SOPORTE +DESINFECCIÓN HYDRO COM SUPORTE DESINFECÇÃO						C-A	C-U	E-A	E-U	F-A	F-U	ØK	* ver tabla seleccionar número de paneles + acabado
150 x 70	58	155	C2315070P	-	-	2.274 €	2.378 €	2.347 €	2.451 €	2.876 €	2.979 €		
160 x 70	58	170	C2316070P										
170 x 70	58	185	C2317070P										
170 x 75	58	200	C2317075P										
170 x 80	58	215	C2317080P										
180 x 80	58	235	C2318080P										

HYDRO PLUS CON SOPORTE COM SUPORTE						C-A	C-U	E-A	E-U	F-A	F-U	ØK	* ver tabla seleccionar número de paneles + acabado
150 x 70	58	155	C2415070P	-	-	3.408 €	3.512 €	3.481 €	3.585 €	4.010 €	4.113 €		
160 x 70	58	170	C2416070P										
170 x 70	58	185	C2417070P										
170 x 75	58	200	C2417075P										
170 x 80	58	215	C2417080P										
180 x 80	58	235	C2418080P										

PARA TODAS LAS OPCIONES VER PÁGINA 536,537



* SELECCIONAR NÚMERO DE PANELES / SELECCIONE O NÚMERO DE PAINÉIS

1 panel/1 Painel	2 paneles/2 painéis	3 paneles/3 painéis

PANEL ACRÍLICO

1A	1U	2A	2U	3A	3U
Blanco brillo Branco brilhante	Blanco mate Branco mate	Blanco brillo Branco brilhante	Blanco mate Branco mate	Blanco brillo Branco brilhante	Blanco mate Branco mate
+ 289 €	+ 348 €	+ 408 €	+ 496 €	+ 530 €	+ 647 €

ACABADO MADERA

1 panel/1 Painel				2 paneles/2 painéis				3 paneles/3 painéis			
1I	1M	1N	1X	2I	2M	2N	2X	3I	3M	3N	3X
Blanco rayado	Grain	Burlington	Dolomite	Blanco rayado	Grain	Burlington	Dolomite	Blanco rayado	Grain	Burlington	Dolomite
+ 376 €				+ 546 €				+ 758 €			

Construcción del código de la bañera sin paneles **Código** + Selección de desagüe/llenado+acabado bañera *Seleção de valvulas/enchimento + acabamento banheira* + selección estructura sin paneles = Código completo del producto *Código completo do produto*

Construcción del código de la bañera con paneles **Código** + Selección de desagüe/llenado+acabado bañera *Seleção de valvulas/enchimento + acabamento banheira* + selección estructura con paneles **(laminado o acabado madera)** = Código completo del producto *Código completo do produto*



BAÑERA CON PANEL BLANCO BRILLO/BRANCO BRILHANTE



BAÑERA CON PANEL BURLINGTON

IRIS | ACABADOS PANELES

PANEL ACRILICO



Blanco brillo
Branco brilhante

PANEL ACABADO MADERA



Blanco rayado



Grain

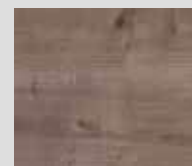

Burlington



Dolomite

IRIS | EQUIPAMIENTO Y FUNCIONES (disponibles según versión)

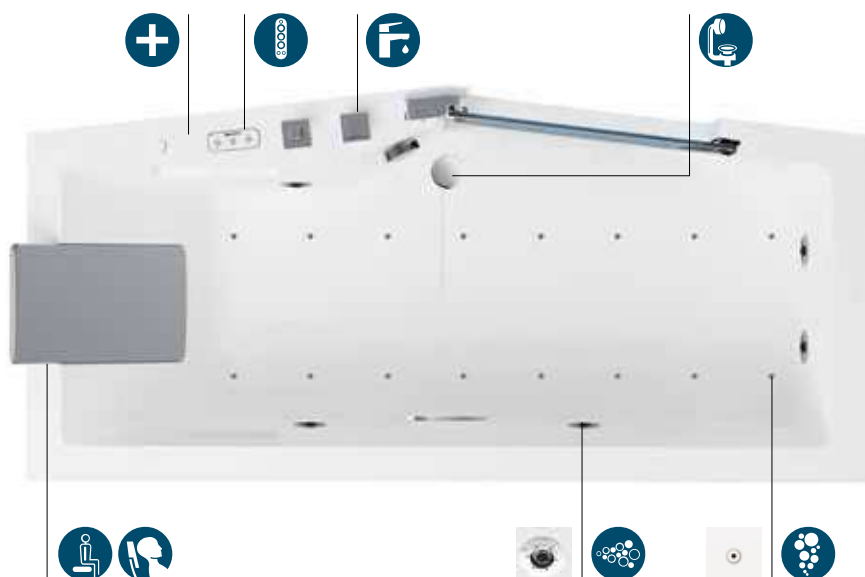

Masaje Airpool mediante jets de aire con regulación manual on/off o programa secuencial, para una estimulación celular eficaz.

Massagem Airpool através de jets de ar com regulação manual on/off ou programa sequencial, para uma estimulação celular eficaz.



Masaje corporal Whirlpool aire/agua con regulación de tiempo e intensidad manual o automática para satisfacer cualquier necesidad de bienestar.

Massagem corpo Whirlpool ar/agua com regulação de tempo e intensidade manual ou automática.



Reposacabezas
Apoia-cabeças



Panel electrónico con funciones de Hidro-secuencia
Panel electrónico com funções de Hidro-sequência



Grifería al borde de la bañera + Tubo de desagüe anti-gotas
Torneira no rebordo da banheira + Tubo de descarga salvagotas



Columna de desagüe
Coluna de desagüe



Desinfección
Desinfecção



Asiento ajustable
Assento adaptável



BAÑERA CON PANELES GRAIN



Reposacabezas / Asiento ajustable
Apoio De Cabeças / Assento adaptável



Puerta de fácil acceso, con cierre de seguridad
Porta de facil acceso com fecho segurança



Grifería monomando para borde de bañera



El hidromasaje Novellini para una completa expresión de nuestros recursos vitales.
A hidromassagem Novellini para uma completa expressão dos nossos recursos vitais.



IRIS

IRIS

BAÑERA DE HIDROMASAJE ANGULAR CON PUERTA DE FÁCIL ACCESO, CON O SIN HIDROMASAJE
BANHEIRA ANGULAR COM PORTA DE FACIL ACESSO, COM O SEM HIDROMASSAGEM

S Izquierda / Esquerda

D Derecha / Direita

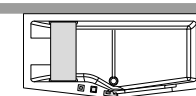
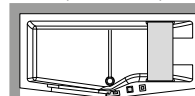

PANELES ACRÍLICOS / PAINEIS ACRILICOS

Medidas			litros	Código	Selección columna de desagüe, grifería y acabado de la bañera Seleção de valvulas/enchimento + acabamento banheira			instalación		selección estructura / paneles Seleção Opções / paineis									
Cm	H	Lt.			Columna de desagüe sin grifería	Columna de desagüe con sistema de llenado	Columna de desagüe con grifería	Izquierda Esquerda	Derecha Direita	con soporte / cm suporte	1 Panel 1 Painel	2 paneles 2 paineis	3 paneles 3 paineis						
STANDARD CON SOPORTE STANDARD COM SUPORTE																			
				C	E		S-	D-	A0	A1	A2	A3							
160x70/80	62	250	IRI216070						3.405 €	3.686 €	3.826 €	3.967 €							
170x70/80	62	265	IRI217080		+ 73 €	-													
180x75/85	62	305	IRI218085						3.766 €	4.047 €	4.187 €	4.328 €							
STANDAR CON SOPORTE + GRIFERIA COM SUPORTE+TORNEIRAS																			
						F	S-	D-	A0K	A1K	A2K	A3K							
160x70/80	62	250	IRI216070	-	-	+ 485 €			3.405 €	3.686 €	3.826 €	3.967 €							
170x70/80	62	265	IRI217080																
180x75/85	62	305	IRI218085						3.766 €	4.047 €	4.187 €	4.328 €							
HIDRO																			
				C	E	F	S-	D-	A0K	A1K	A2K	A3K							
160x70/80	62	250	IRI316070T						5.475 €	5.756 €	5.897 €	6.037 €							
170x70/80	62	265	IRI317080T		+ 73 €	+ 485 €													
180x75/85	62	305	IRI318085T						5.837 €	6.118 €	6.258 €	6.399 €							
HYDRO PLUS																			
				C	E	F	S-	D-	A0K	A1K	A2K	A3K							
160x70/80	62	250	IRI416070T						6.270 €	6.551 €	6.692 €	6.832 €							
170x70/80	62	265	IRI417080T		+ 73 €	+ 485 €													
180x75/85	62	305	IRI418085T						6.633 €	6.914 €	7.054 €	7.195 €							

PANELES ACABADO MADERA

Medidas			litros	Código	Selección columna de desagüe, grifería y acabado de la bañera Seleção de valvulas/enchimento + acabamento banheira			instalación		selección estructura / paneles Seleção Opções / paineis									
Cm	H	Lt.			Columna de desagüe sin grifería	Columna de desagüe con sistema de llenado	Columna de desagüe con grifería	Izquierda Esquerda	Derecha Direita	1 Panel 1 Painel	2 paneles 2 paineis	3 paneles 3 paineis	Blanco rayado Branco listrado	Grain	Burlington	Dolomite			
STANDARD CON SOPORTE STANDARD COM SUPORTE																			
				C	E		S-	D-	A1	A2	A3	I	M	N	X				
160x70/80	62	250	IRI216070						3.707 €	3.857 €	4.009 €								
170x70/80	62	265	IRI217080		+ 73 €	-													
180x75/85	62	305	IRI218085						4.068 €	4.219 €	4.370 €								
STANDAR CON SOPORTE + GRIFERIA COM SUPORTE+TORNEIRAS																			
						F	S-	D-	A1	A2	A3	I	M	N	X				
160x70/80	62	250	IRI216070	-	-	+ 485 €			3.707 €	3.857 €	4.009 €								
170x70/80	62	265	IRI217080																
180x75/85	62	305	IRI218085						4.068 €	4.219 €	4.370 €								
HIDRO																			
				C	E	F	S-	D-	A1	A2	A3	I	M	N	X				
160x70/80	62	250	IRI316070T						5.777 €	5.929 €	6.079 €								
170x70/80	62	265	IRI317080T		+ 73 €	+ 485 €													
180x75/85	62	305	IRI318085T						6.140 €	6.290 €	6.442 €								
HYDRO PLUS																			
				C	E	F	S-	D-	A1	A2	A3	I	M	N	X				
160x70/80	62	250	IRI416070T						6.572 €	6.724 €	6.874 €								
170x70/80	62	265	IRI417080T		+ 73 €	+ 485 €													
180x75/85	62	305	IRI418085T						6.936 €	7.086 €	7.238 €								



IRIS COMBY

	Medidas	Código	instalación	Precio / Preço	
IRIS COMBY - MAMPARA DE BAÑERA, UN FIJO Y UNA PUERTA GIRATORIA HACIA EL INTERIOR RESGUARDO DE BANHEIRA, UM FIXO E UMA PORTA GIRATÓRIA PARA O INTERIOR					
	altura		D	S	1K
	Cm		 Derecha Direita	 Izquierda Esquerda	
	150	IRIS2V80	D-		593 €
	150	IRIS2V80		S-	593 €
IRIS COMBY 2 IRIS COMBY - MAMPARA DE BAÑERA UN FIJO Y UNA PUERTA GIRATORIA HACIA EL INTERIOR, CON FIJO LATERAL RESGUARDO DE BANHEIRA, UM FIXO E UMA PORTA GIRATÓRIA PARA O INTERIOR, COM FIXO LATERAL					
	Pannello Fisso		D	S	1K
	Cm		 Derecha Direita	 Izquierda Esquerda	
	70	IRIS2VF8070	D-		1.001 €
	75	IRIS2VF8075	D-		1.030 €
	70	IRIS2VF8070		S-	1.001 €
75	IRIS2VF8075		S-	1.030 €	



PARA TODAS LAS OPCIONES VER PÁGINA 536,537

CALYPSO

BAÑERA RECTANGULAR RECTANGULAR BANHEIRAS

Medidas			litros	Código	Selección columna de desagüe, grifería y acabado de la bañera Seleção de valvulas/enchimento + acabamento banheira			instalación		Selección Estructura Seleção Opções			
Cm	H	Lt.			Columna de desagüe sin grifería	Columna de desagüe con sistema de llenado	Columna de desagüe con grifería	Izquierda Esquerda	Derecha Direita	con soporte cm suporte	1 Panel 1 Painel	2 paneles 2 paineis	3 paneles 3 paineis
STANDAR PARA EMPOTRAR STANDAR PARA EMBUTIR													
150 x 70	55	150	CAL115070-A										
160 x 70	55	160	CAL116070-A										
170 x 70	55	170	CAL117070-A										
170 x 75	55	180	CAL117075-A										
170 x 80	55	190	CAL117080-A										
180 x 80	55	200	CAL118080-A										
											290 €		
STANDAR CON SOPORTE STANDAR COM SUPORTE													
				C-	E-	F-				A0	A1	A2	A3
150 x 70	55	150	CAL215070										
160 x 70	55	160	CAL216070										
170 x 70	55	170	CAL217070										
170 x 75	55	180	CAL217075		+ 73 €	+ 602 €	-	-	530 €	719 €	799 €	879 €	
170 x 80	55	190	CAL217080										
180 x 80	55	200	CAL218080										
HYDRO CON SOPORTE SIN DESINFECCION COM SUPORTE SEM DESINFECCÃO													
				C	E	F	S-	D-	A0K	A1K	A2K	A3K	
150 x 70	55	150	CAL5150700										
160 x 70	55	160	CAL5160700										
170 x 70	55	170	CAL5170700										
170 x 75	55	180	CAL5170750		+ 73 €	+ 602 €			1.168 €	1.356 €	1.436 €	1.518 €	
170 x 80	55	190	CAL5170800										
180 x 80	55	200	CAL5180800										
HYDRO CON SOPORTE +DESINFECCIÓN HYDRO COM SUPORTE DESINFECCÃO													
				C	E	F	S-	D-	A0K	A1K	A2K	A3K	
150 x 70	55	150	CAL315070P										
160 x 70	55	160	CAL316070P										
170 x 70	55	170	CAL317070P										
170 x 75	55	180	CAL317075P		+ 73 €	+ 602 €			1.479 €	1.667 €	1.748 €	1.827 €	
170 x 80	55	190	CAL317080P										
180 x 80	55	200	CAL318080P										
HYDRO PLUS CON SOPORTE COM SUPORTE													
				C	E	F	S-	D-	A0K	A1K	A2K	A3K	
150 x 70	55	150	CAL415070P										
160 x 70	55	160	CAL416070P										
170 x 70	55	170	CAL417070P										
170 x 75	55	180	CAL417075P		+ 73 €	+ 602 €			2.218 €	2.405 €	2.486 €	2.565 €	
170 x 80	55	190	CAL417080P										
180 x 80	55	200	CAL418080P										
ECO CON SOPORTE SIN DESINFECCION													
				C	E	F	S-	D-	A0K	A1K	A2K	A3K	
150 x 70	55	150	CAL615070MCS-										
160 x 70	55	160	CAL616070MCS-										
170 x 70	55	170	CAL617070MCS-										
170 x 75	55	180	CAL617075MCS-								1.182 €		
170 x 80	55	190	CAL617080MCS-										
180 x 80	55	200	CAL618080MCS-										

PARA TODAS LAS OPCIONES VER PÁGINA 536,537





SELECCIÓN ACABADO BAÑERA
ACABAMENTOS



Blanco brillo
Branco brilhante

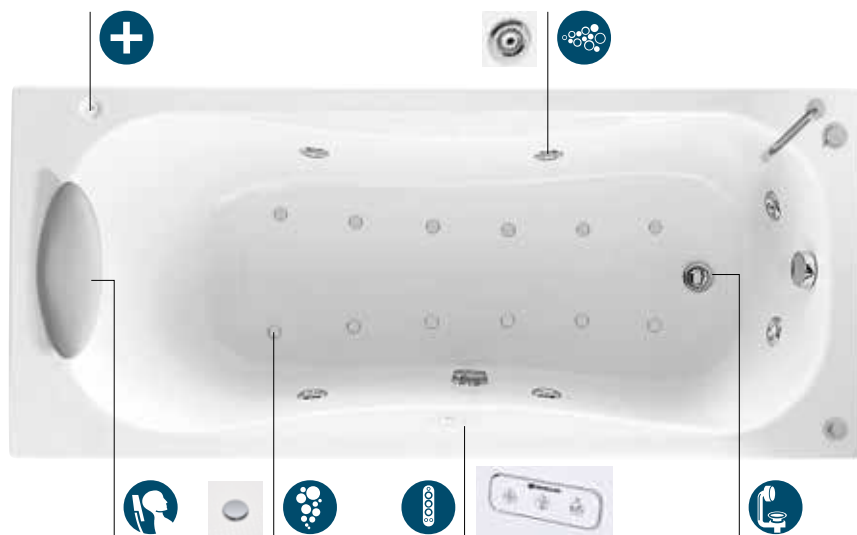

IZQUIERDA
ESQUERDA

DERECHA
DIREITA

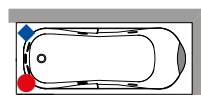
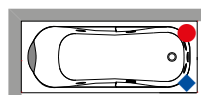

VERSIÓN STANDARD

- GRIFERÍA
- ◆ DUCHA

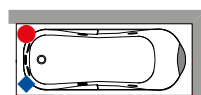
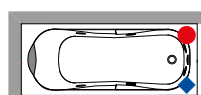

VERSIÓN HYDRO

- GRIFERÍA
- ◆ DUCHA



EQUIPAMIENTO Y FUNCIONES

(disponibles según versión)



Masaje Airpool mediante jets de aire con regulación manual on/off o programa secuencial, para una estimulación celular eficaz.

Massagem Airpool através de jets de ar com regulação manual on/off ou programa sequencial, para uma estimulação celular eficaz.



Masaje corporal Whirlpool aire/agua con regulación de tiempo e intensidad manual o automática para satisfacer cualquier necesidad de bienestar.

Massagem corpo Whirlpool ar/agua com regulação de tempo e intensidade manual ou automática.



Reposacabezas
Apoia-cabeças



Panel electrónico con funciones de Hidro-secuencia
Painel electrónico com funções de Hidro-sequência



Columna de desagüe
Coluna de desagüe



Desinfección
Desinfecção

CALYPSO

CALYPSO

VOGUE

BAÑERA ANGULAR ASIMÉTRICA SEMICIRCULAR

Medidas			litros	Código	Selección columna de desagüe, grifería y acabado de la bañera Selecção de valvulas/enchimento + acabamento banheira	instalación	selección de paneles Selecção de painels
Cm	H	Lt.			Columna de desagüe sin grifería Columna de desagüe con sistema de llenado Columna de desagüe con grifería	Izquierda Esquerda Derecha Direita	con soporte cm suporte 1 Panel 1 Painel

STANDAR PARA EMPOTRAR STANDAR PARA EMBUTIR				C	E	F	S-A	D-A	
150 X 85	55	140	VOG115085	-	-	-	832 €	832 €	
165 X 85	55	180	VOG116585						

STANDARD CON SOPORTE STANDARD COM SUPORTE				C	E	F	S-	D-	A0	A1
150 X 85	55	140	VOG215085		+ 74 €	+ 613 €			1.319 €	1.648 €
165 X 85	55	180	VOG216585							

HYDRO CON SOPORTE SIN DESINFECCION COM SUPORTE SEM DESINFECÇÃO				C	E	F	S-	D-	A0K	A1K
150 X 85	55	140	VOG5150850		+ 74 €	+ 613 €			2.274 €	2.604 €
165 X 85	55	180	VOG5165850							

HYDRO CON SOPORTE +DESINFECCIÓN HYDRO COM SUPORTE DESINFECÇÃO				C	E	F	S-	D-	A0K	A1K
150 X 85	55	140	VOG315085P		+ 74 €	+ 613 €			2.806 €	3.135 €
165 X 85	55	180	VOG316585P							

HYDRO PLUS CON SOPORTE COM SUPORTE				C	E	F	S-	D-	A0K	A1K
150 X 85	55	140	VOG415085P		+ 74 €	+ 613 €			4.295 €	4.625 €
165 X 85	55	180	VOG416585P							

ECO CON SOPORTE SIN DESINFECCION				C	E	F	S-	D-	A0K	A1K
150 X 85	55	140	VOG615085MC	-	-	-			-	1.993 €
165 X 85	55	180	VOG616585MC							

PARA TODAS LAS OPCIONES VER PÁGINA 536,537



SELECCIÓN ACABADO BAÑERA
ACABAMENTOS



Blanco brillo
Branco brilhante



EQUIPAMIENTO Y FUNCIONES

(disponibles según versión)



Massaggio Airpool (12 jets) a getto d'aria con accensione manuale on/off. Per una **efficace stimolazione cellulare**



Masaje corporal Whirlpool aire/agua, para satisfacer cualquier necesidad de bienestar.

Massagem corpo Whirlpool ar/agua.



Panel electrónico con funciones de Hidro-secuencia
Panel electrónico com funções de Hidro-sequência



Reposacabezas
Apoia-cabeças



Columna de desagüe
Coluna de desagüe



Desinfección
Desinfecção

VOGUE

VOGUE



BABY



SELECCIÓN ACABADO BAÑERA
ACABAMENTOS

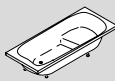

Blanco brillo
Branco brilhante

Medidas	litros	Código	Precio / Preço	
Cm	Lt			
BABY - PARA EMPOTRAR				
140 x 70 x 40 H	100	BAB14070-A	451 €	
BABY - PARA EMPOTRAR				
105 x 70 x 46	61	BAT10570-A	451 €	
120 x 70 x 45	81	BAT12070-A		



BABY



BABY TWO

ACCESORIOS Y COMPLEMENTOS OPCIONALES / ACESSÓRIOS E COMPLEMENTOS OPCIONAL

REPOSACABEZAS EN EVA *
REPOUSA CABEÇAS IN EVA *
para Divina y Divina O

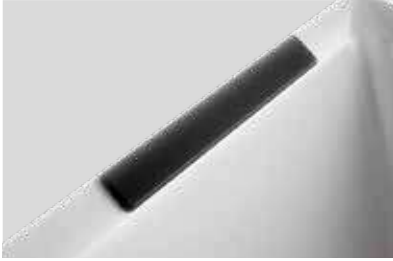

Código	Precio / Preço
POGDIV	135 €

REPOSACABEZAS EN EVA *
REPOUSA CABEÇAS IN EVA *
para Divina C



Código	Precio / Preço
POGDIVC	135 €

REPOSACABEZAS EN EVA *
REPOUSA CABEÇAS IN EVA *
para Iris versión entre paredes



Código	Precio / Preço
POGIRIN	164 €

REPOSACABEZAS EN EVA *
REPOUSA CABEÇAS IN EVA *
para Calos 2.0



Código	Precio / Preço
POGCA1	74 €

REPOSACABEZAS EN EVA *
REPOUSA CABEÇAS IN EVA *
para Calypso



Código	Precio / Preço
POGCAL	74 €

REPOSACABEZAS EN EVA *
REPOUSA CABEÇAS IN EVA *
para Vogue



Código	Precio / Preço
POGVOG	74 €

REPOSACABEZAS EN EVA *
REPOUSA CABEÇAS IN EVA *
para Stile



Código	Precio / Preço
POGSTI-H	135 €

REPOSACABEZAS EN EVA *
REPOUSA CABEÇAS IN EVA *
para Stile C



Código	Precio / Preço
POGSTIC-H	135 €

REPOSACABEZAS EN EVA *
REPOUSA CABEÇAS IN EVA *
para Sense 3-4 2.0



Código	Precio / Preço
POGS2034-A	135 €

*EVA es un material atóxico, antibacterias e hidro-repelente / *EVA é um material atóxico, antibacterias e hidro-repelente

ACCESORIOS Y COMPLEMENTOS OPCIONALES / ACESSÓRIOS E COMPLEMENTOS OPCIONAL

ACCESORIO PORTAOBJETOS PARA BORDE DE BAÑERA

para Divina, Dlvina C, O y F



Código	Precio / Preço
R90PODIV	223 €

ACCESORIO PORTAOBJETOS PARA BORDE DE BAÑERA

per Divina e Divina F



ancho	Código	Precio Preço
70 cm	R90VADIV70	371 €
75 cm	R90VADIV75	371 €
80 cm	R90VADIV80	371 €
90 cm	R90VADIV90	371 €

PERFIL EMBELLECEDOR RÍGIDO DE ALUMINIO



Medidas	Código	Precio Preço
1 lado 185 cm	PRV185-30	89 €
2 lados / 2 painéis 185x85	PRV18585-30	114 €
3 lados / 3 painéis 85x185x85 cm	PRV8518585-30	136 €

PERFIL EMBELLECEDOR PERFIL EMBELEZADOR



Código	Precio / Preço
PRVA2-A	98 €

KIT 2 EMBELLECEDORES DE PLÁSTICO RÍGIDO 195 CM



Código	Precio / Preço
PRVA195-30	78 €

TUBO DESAGÜE ANTI-GOTA



Código	Precio / Preço
R90SCDOCBV	147 €

IRIS, CALOS, UNA, VOGUE,
VENUS, CALYPSO

COLUMNA DE DESAGÜE



SENSE 2.0

Código	Precio / Preço
COLSCAVK-K	105 €

CALYPSO, VOGUE, VENUS, CALOS

Código	Precio / Preço
COLSCA-K	105 €

COLUMNA DE DESAGÜE CON SISTEMA DE LLENADO / VALVULA DE DESCARGA COM SISTEMA DE ENCHIMENTO



Código	Precio / Preço
COLSCAE-K	136 €

PANEL DE INSPECCIÓN PAINEL DE INSPECÇÃO 60x33x2 cm



SENSE 2.0

Código	Precio / Preço
PANISPEL-A	177 €

IRIS, CALOS, UNA, VOGUE,
VENUS, CALYPSO, BABY

Código	Precio / Preço
PANISP-A	177 €

**KIT PIES REGULABLES PARA BAÑERA
EMPOTRAR / PÉS DE REGULAÇÃO
PARA BANHEIRA EMBUTIR**
para Sense, Divina, Iris, Calos



Código	Precio / Preço
PIEDVASCA	68 €

**KIT PIES REGULABLES
PÉS DE REGULAÇÃO**
para Calos 2.0, Una, Vogue, Venus, Calypso



Código	Precio / Preço
PIEDVASCA70	74 €
PIEDVASCA75	74 €
PIEDVASCA80	74 €
PIEDVASCA90	74 €
PIEDVASCA100	74 €

**KIT ADAPTACIÓN MAMPARA
PARA BAÑERA DIVINA**



Para poder instalar la mampara en una bañera DIVINA, pedir :

1 mampara YOUNG 1V / 1BSV
1 kit accesorios bañera

ver. pag. 313 y 315

KIT HYDROSILENCE

Paneles insonorizantes que se fijan al faldón de la bañera para favorecer la insonorización y reducir el ruido y las vibraciones.
Painéis acústicos a serem fixados no avental da banheira para promover a insonorização e reduzir o ruído e as vibrações.



DIVINA DUAL - SENSE DUAL

Medidas	Estructura	Código	Precio Preço
190 x 140	1 Panel / 1 Painel	KUSDIV1F19014	339 €
190 x 140	2 paneles / 2 painels	KUSDIV1FL19014	376 €
190 x 140	3 paneles / 3 Paneis	KUSDIV1F2L19014	418 €
190 x 140	4 paneles / 4 Paneis	KUSDIV2F2L19014	466 €

DIVINA C - STILE C

Medidas	Estructura	Código	Precio Preço
140 x 140	1 Panel / 1 Painel	KUSDIVC	267 €

DIVINA O

Medidas	Estructura	Código	Precio Preço
165 X 98	1 Panel / 1 Painel	KUSDIVO	301 €

DIVINA - SENSE 2.0 3-4 - STILE - CALOS 160/170 - ÎLOT

Medidas	Estructura	Código	Precio Preço
160/170	4 paneles / 4 Paneis	KUSDIV2F2L160	322 €

DIVINA - SENSE 2.0 3-4 - STILE - CALOS 180/190 -

Medidas	Estructura	Código	Precio Preço
180/190	4 paneles / 4 Paneis	KUSDIV2F2L190	310 €

DIVINA - SENSE 2.0 3-4 - STILE - CALOS - A UNA SOLA PARED

Estructura	Código	Precio / Preço
3 paneles / 3 Paneis	KUSDIV1F2L	281 €

DIVINA - SENSE 2.0 3-4 - STILE - CALOS - EN ANGULO

Estructura	Código	Precio / Preço
2 paneles / 2 painels	KUSDIV1F1L	253 €

DIVINA - SENSE 2.0 3-4 - STILE - CALOS - ENTRE PAREDES

Estructura	Código	Precio / Preço
1 Panel / 1 Painel	KUSDIV1F	241 €

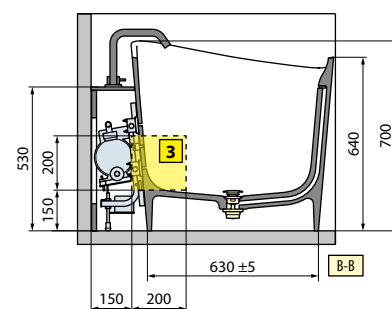
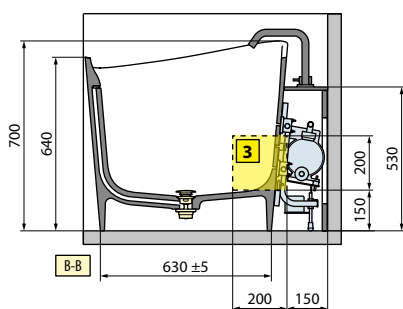
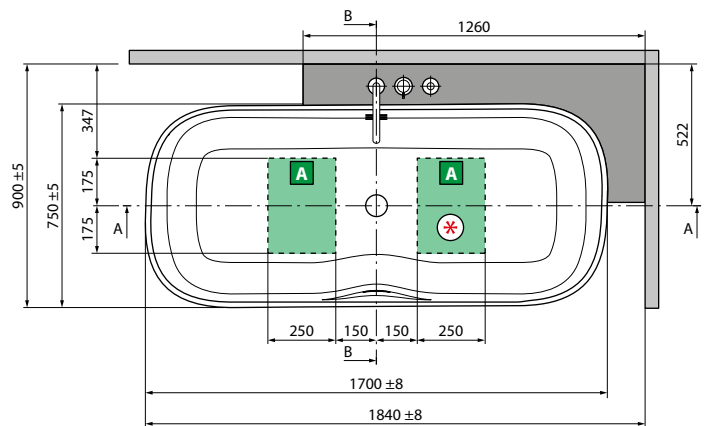
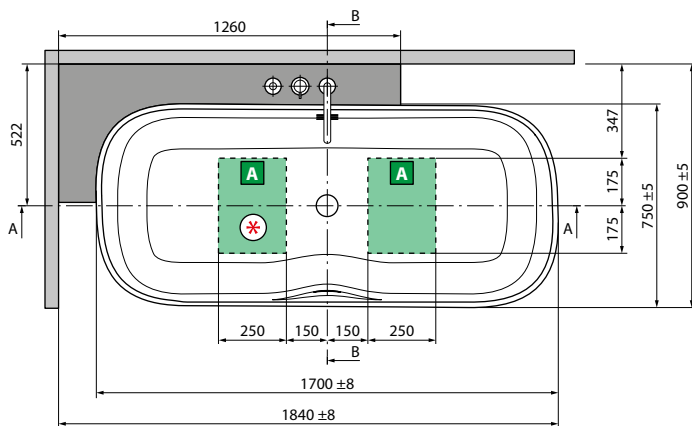
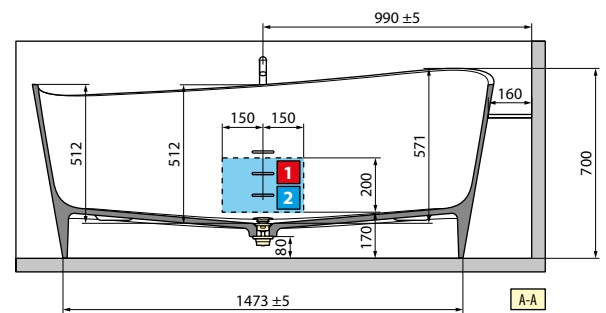
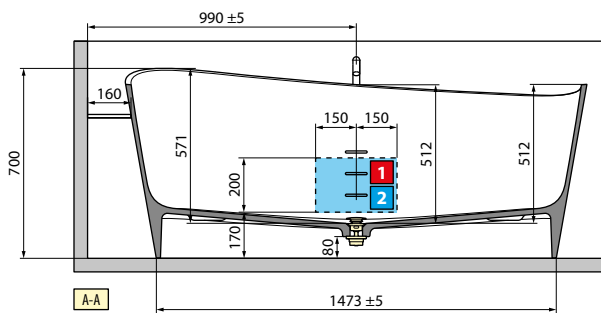
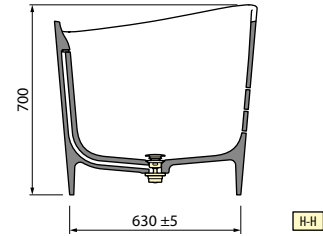
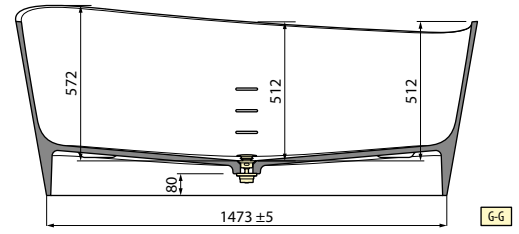
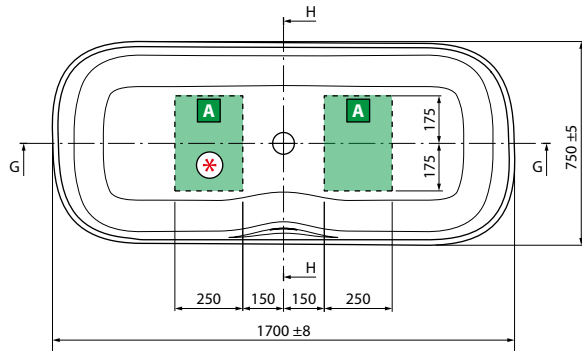

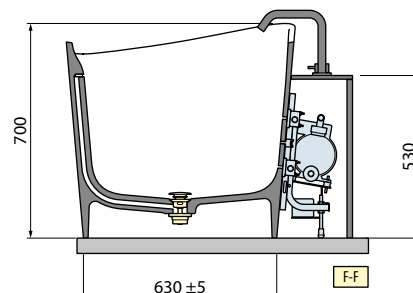
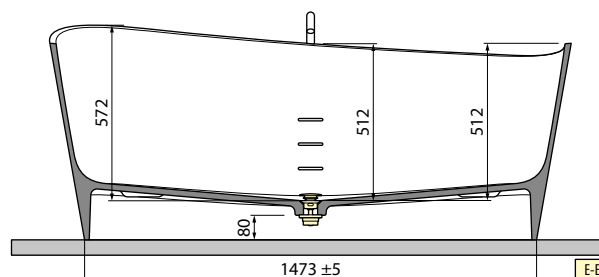
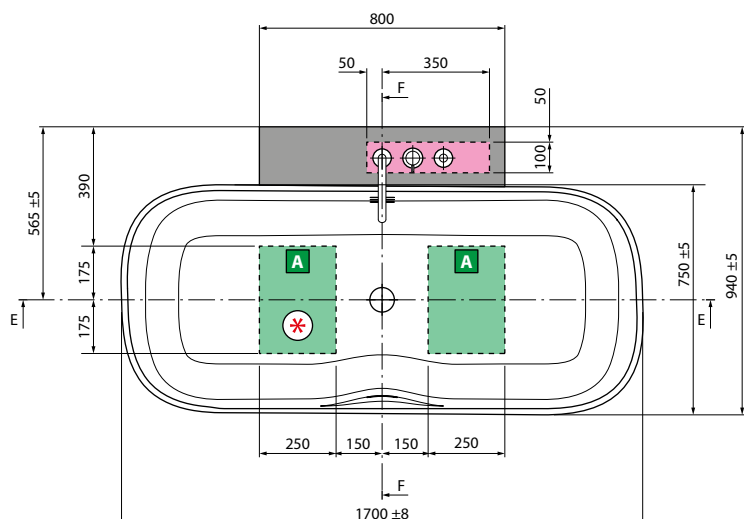
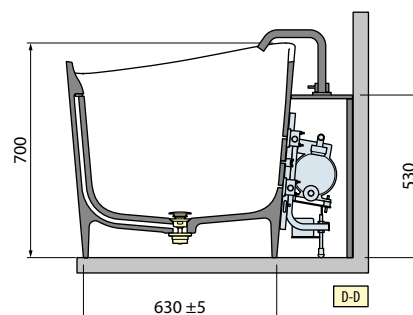
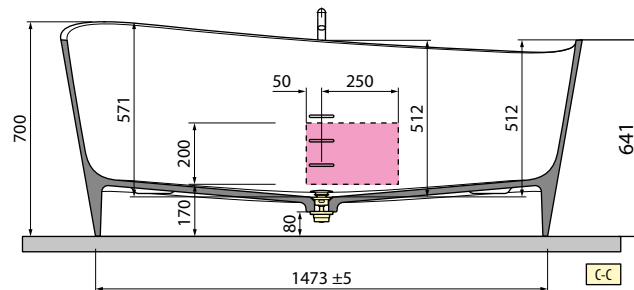
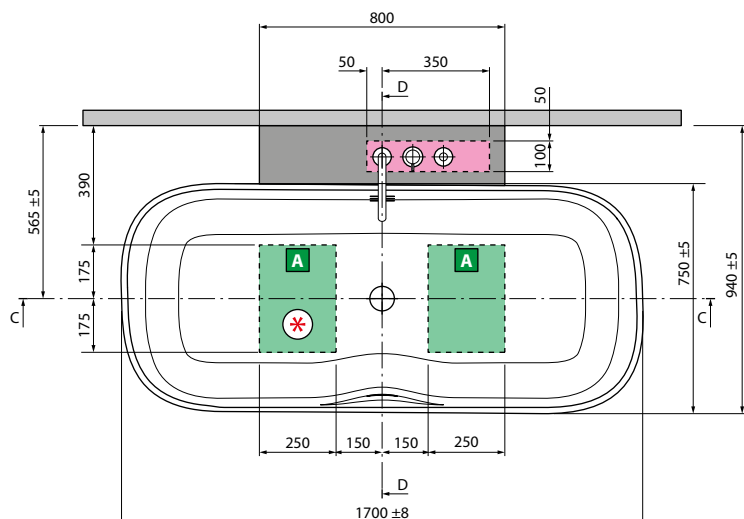

* Zona habilitada para conexión eléctrica en el caso de incluir luz perimetral. Se debe prever la instalación de un interruptor para encendido/apagado (no se suministra)

MODELO / MODÉLE	PESO	CAPACIDAD LITROS
Infinitive	135 kg	360 lt

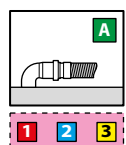

CARACTERÍSTICAS HIDRÁULICAS

1 jet Natural Air
Sifón con conexión 40 mm

CARACTERÍSTICAS ELÉCTRICAS

Tensión: / Tensão: 220-230 V
Frecuencia: / Frequência 50 Hz
Potencia máxima absorbida
Potencia máxima absorbida:
Natural Air: 1050 W

Debe instalarse un interruptor diferencial de 30 mA con una apertura mínima de los contactos igual a 3 mm. fabricado según la legislación vigente. Deve instalar-se um interruptor diferencial de 30mA com uma abertura mínima dos contactos igual a 3 mm. Fabricado segundo as normas.

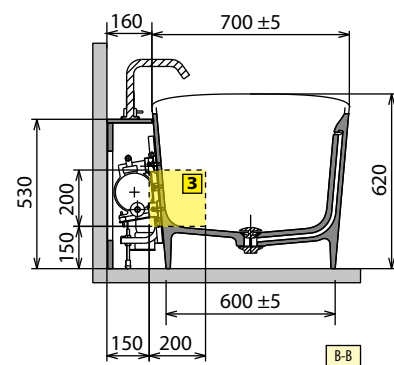
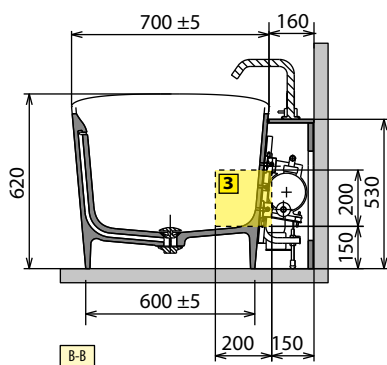
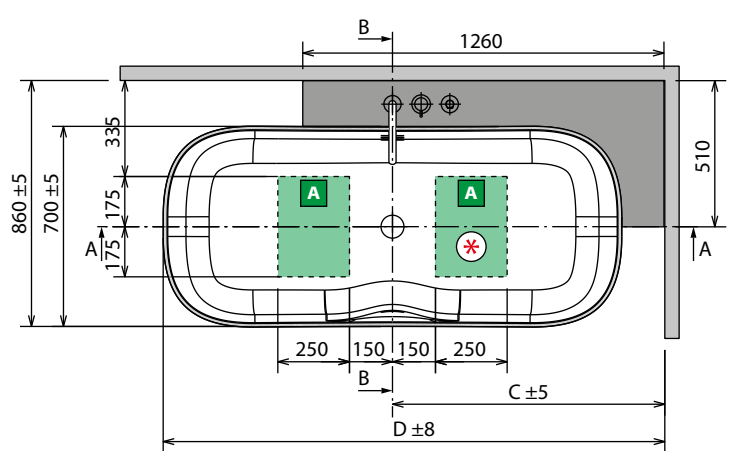
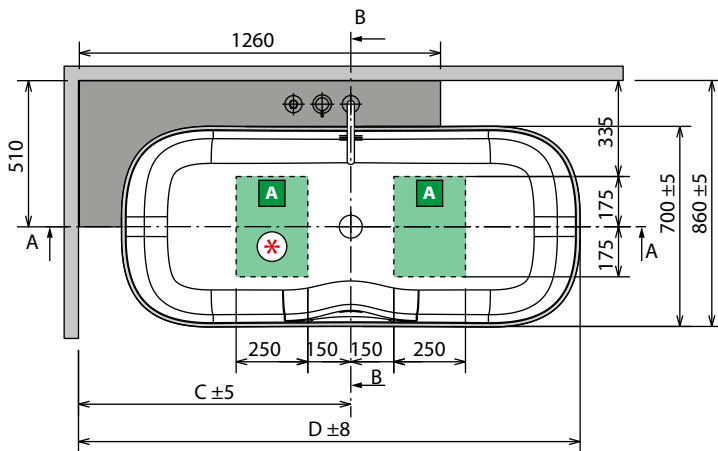
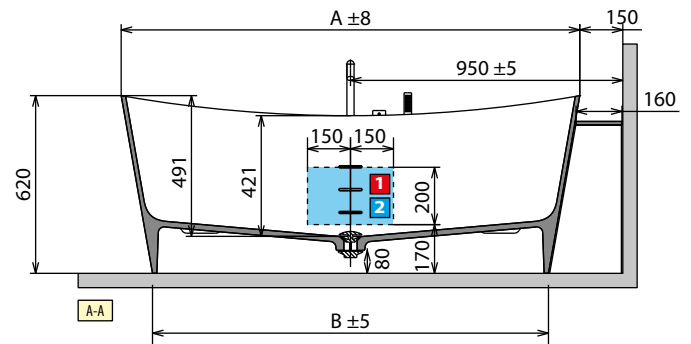
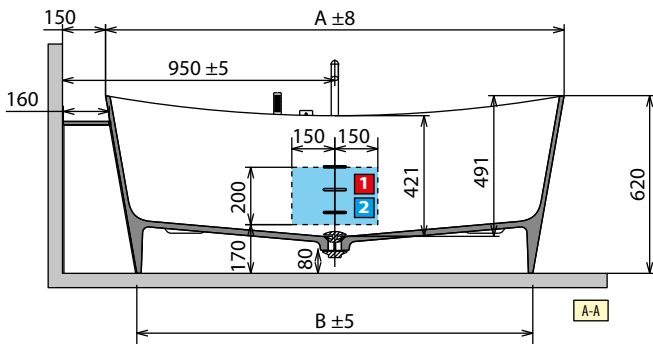
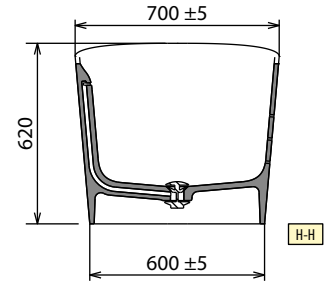
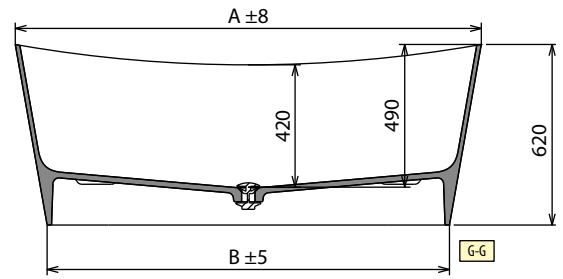
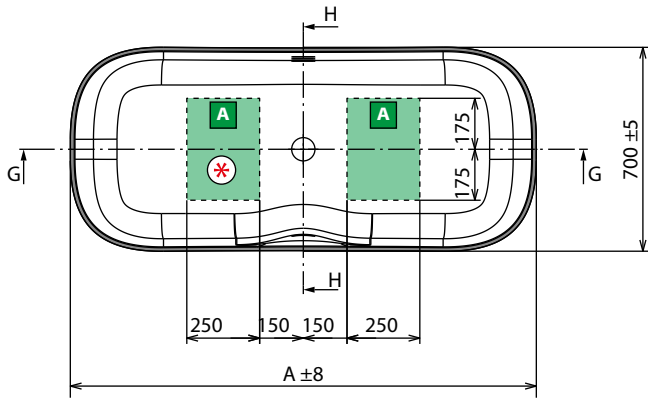

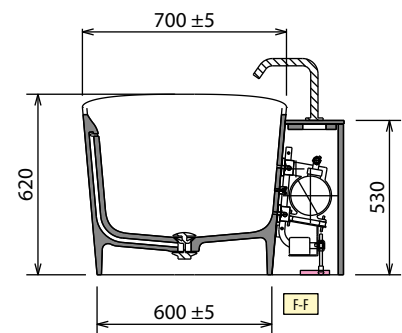
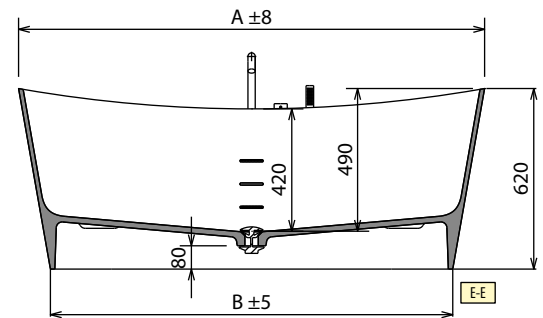
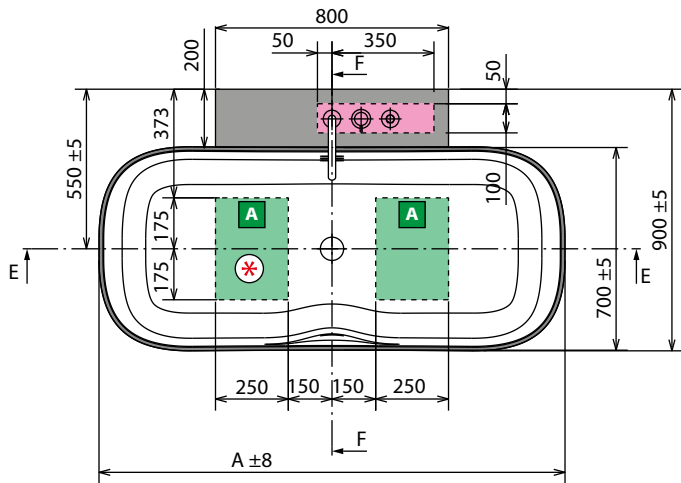
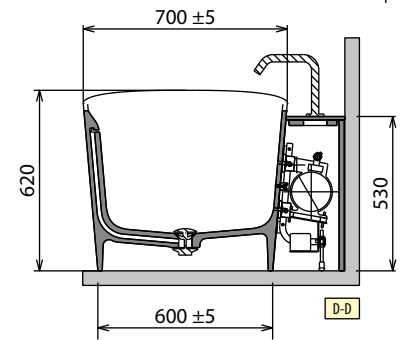
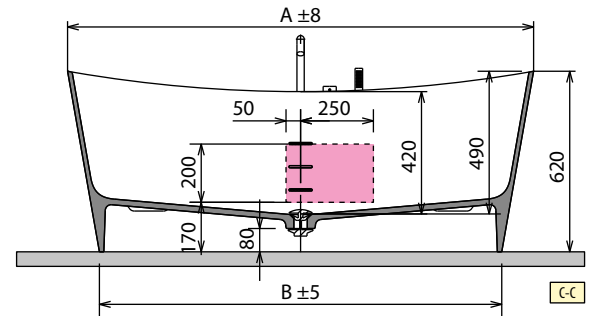
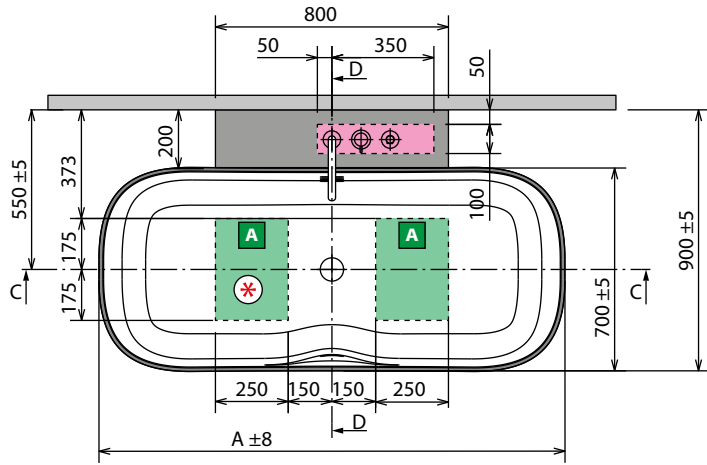

* Zona habilitada para conexión eléctrica en el caso de incluir luz perimetral. Se debe prever la instalación de un interruptor para encendido/apagado (no se suministra)

MODELO / MODÈLE	A	B	C	D	PESO	CAPACIDAD LITROS
Ship 150	1500 mm	1280 mm	900 mm	1650 mm	105 kg	260 lt
Ship 160	1600 mm	1380 mm	950 mm	1750 mm	115 kg	290 lt

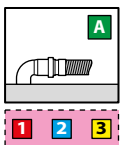

CARACTERÍSTICAS HIDRÁULICAS
1 jet Natural Air
Sifone con attacco 40 mm

CARACTERÍSTICAS ELÉCTRICAS
Tensión: / Tensão: 220-230 V
Frecuencia: / Frequência 50 Hz
Potencia máxima absorvida
Potencia máxima absorvida:
Natural Air: 1050 W

Debe instalarse un interruptor diferencial de 30 mA con una apertura mínima de los contactos igual a 3 mm. fabricado según la legislación vigente. Deve instalar-se um interruptor diferencial de 30mA com uma abertura mínima dos contactos igual a 3 mm. Fabricado segundo as normas.

VERSIÓN IZQUIERDA / VERSÃO ESQUERDA

VERSIÓN DERECHA / VERSÃO DIREITA

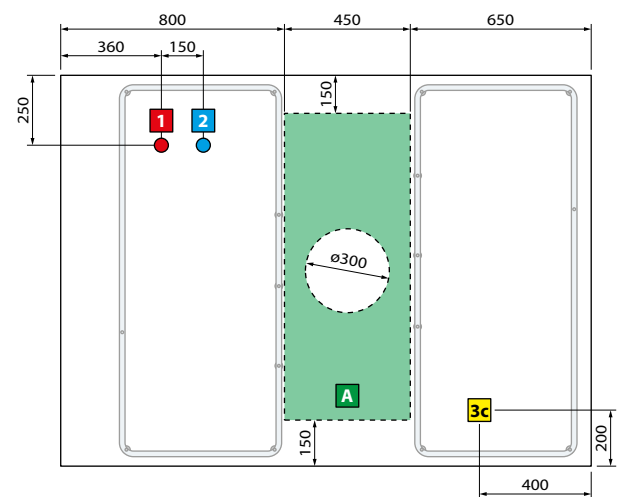
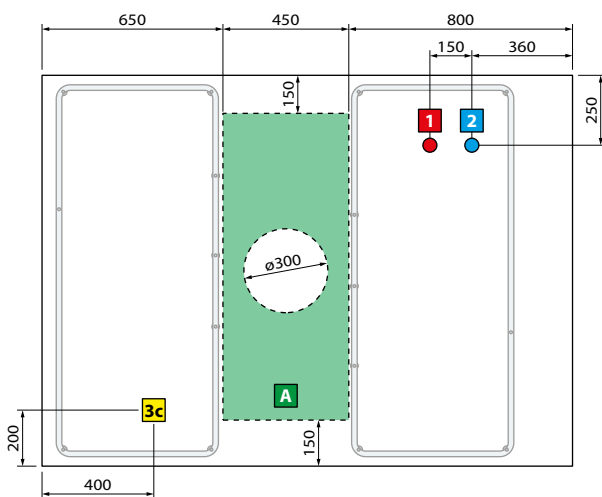
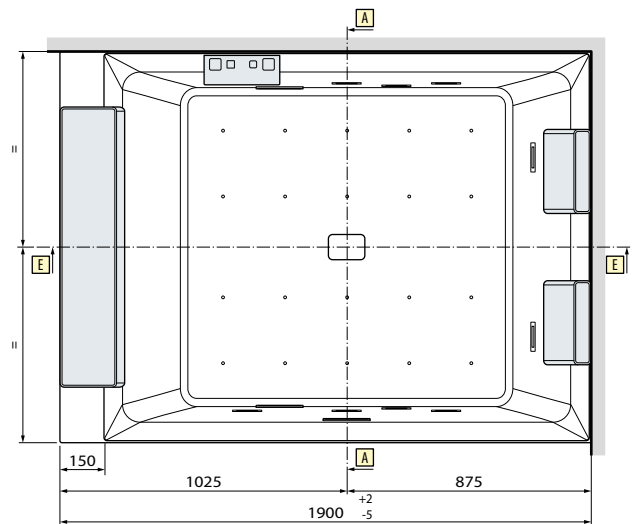
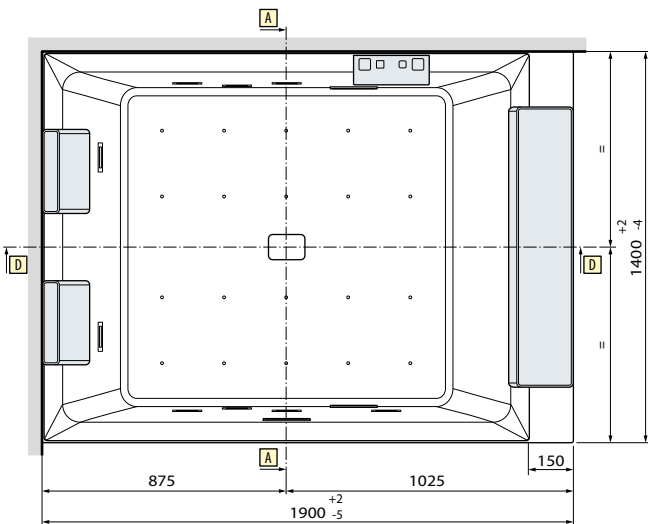
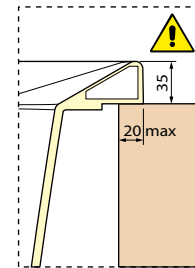
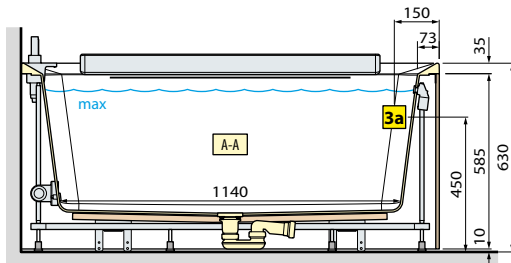
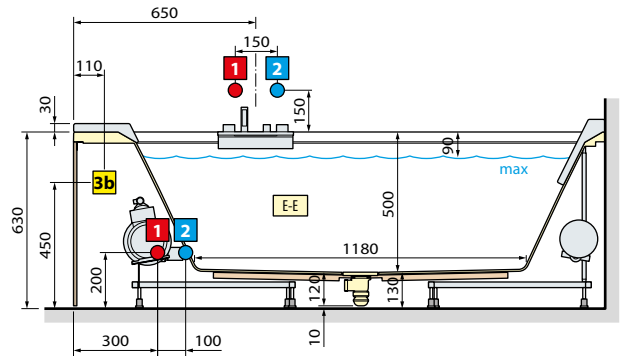
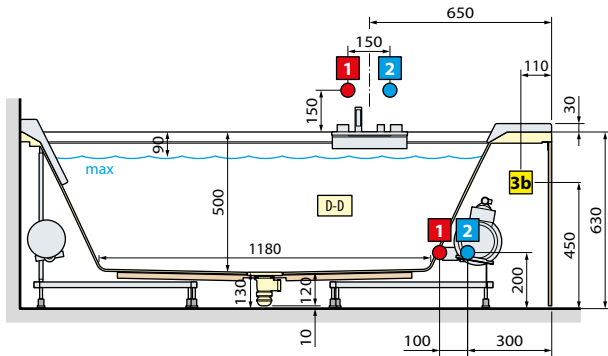

ATENCIÓN!! Puede ser perjudicial para las personas que utilizan marcapasos
ATENÇÃO!! Pode ser prejudicial para pessoas que usem pacemaker

Debe instalarse un interruptor diferencial de 30 mA con una apertura mínima de los contactos igual a 3 mm. fabricado según la legislación vigente.

Deve instalar-se um interruptor diferencial de 30mA com uma abertura mínima dos contactos igual a 3 mm. Fabricado segundo as normas.

VERSIÓN IZQUIERDA / VERSÃO ESQUERDA

VERSIÓN DERECHA / VERSÃO DIREITA

▶
VERSIÓN ENTRE PAREDES

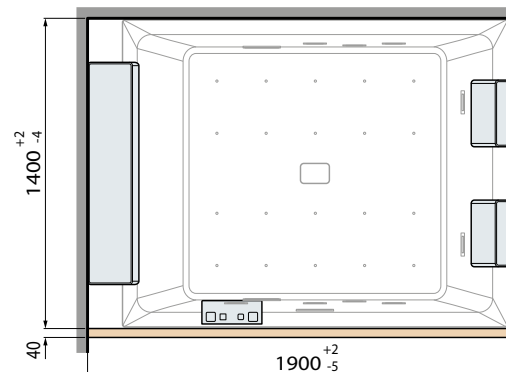
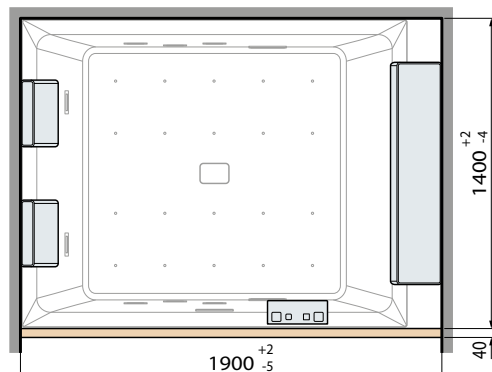

▶
VERSIÓN EN ÁNGULO

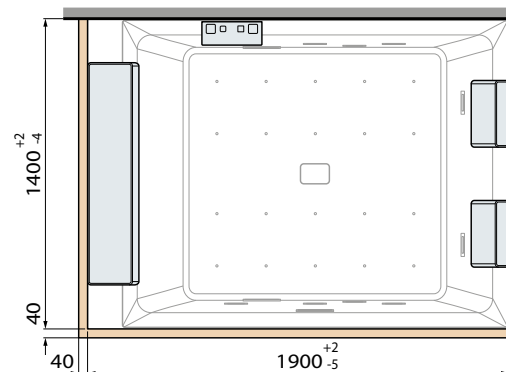
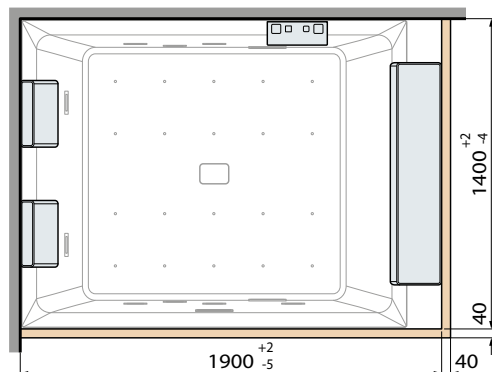

▶
VERSIÓN A CENTRO PARED

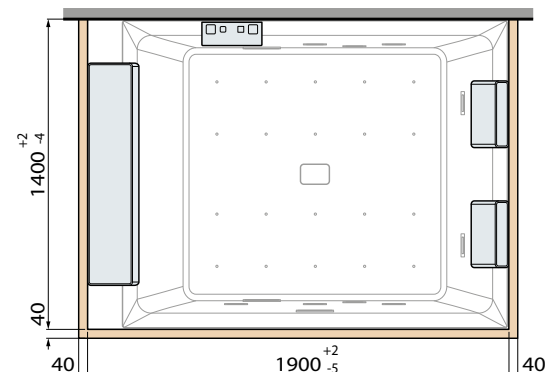
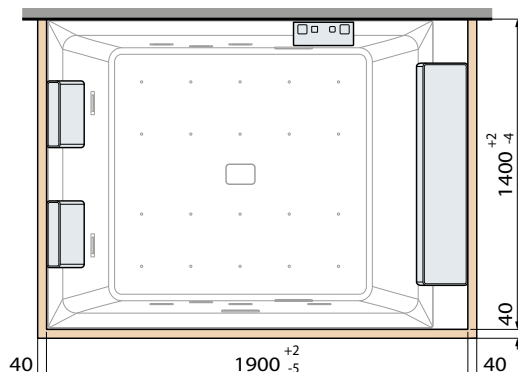

▶
VERSIÓN EXENTA

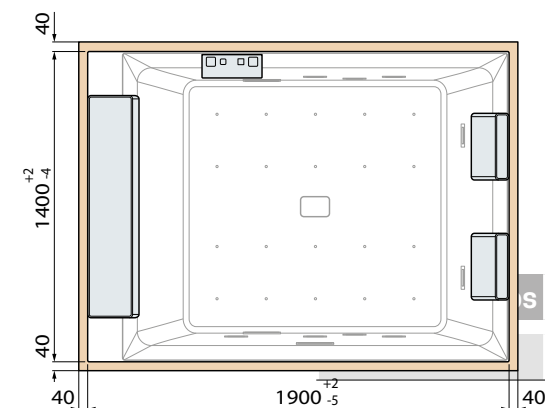
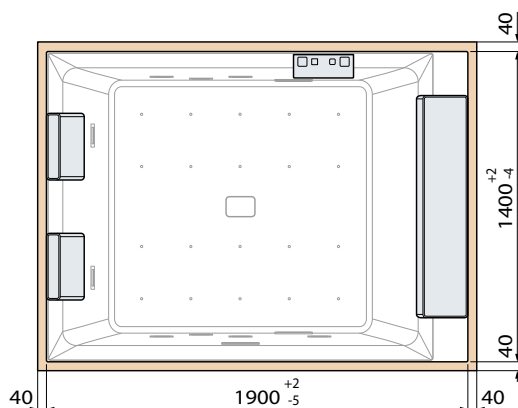

Capacidad litros

650

CARACTERÍSTICAS HIDRÁULICAS

- 20 jets Airpool
- 8 jets Whirlpool
- 2 jets Natural Air
- Cascada
- Conexión del sifón de 1 1/2" /
Ligação sifão de 1 1/2"

CARACTERÍSTICAS ELÉCTRICAS

- Tensión: 220-230 V / Tensão: 220-230 V
- Frecuencia: 50 Hz / Freqüência: 50 Hz
- Potencia máxima absorbida / Potencia
maxima absorbida: 2350 W
- Hydro: 900+900 W
- Airpool: 400 W
- Natural Air: 1050 W
- Calentador: 1300 W
- Cascada: 550 W

CARACTERÍSTICAS MECÁNICAS:

- Área total: 2,66 m²
- masa de la bañera+componentes: 150 kg
- masa del agua: máximo 650 kg.
- masa de los usuarios (2 pers.): 75+75 kg.
- masa especifica 400 kg/m²

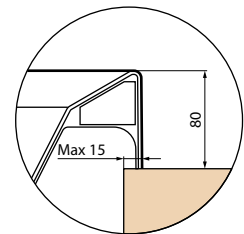
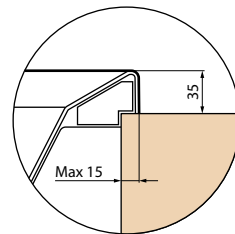
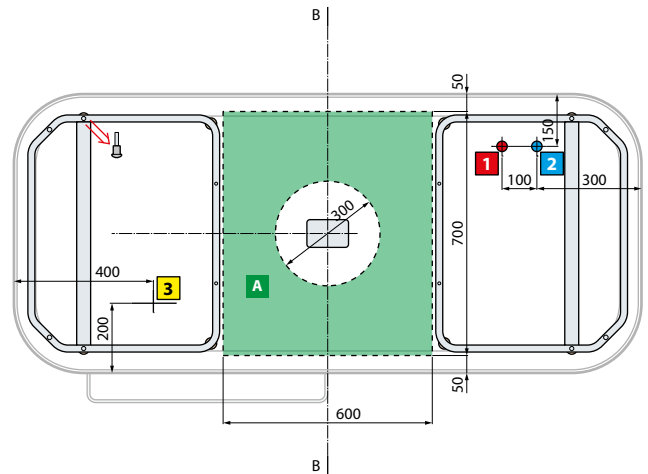
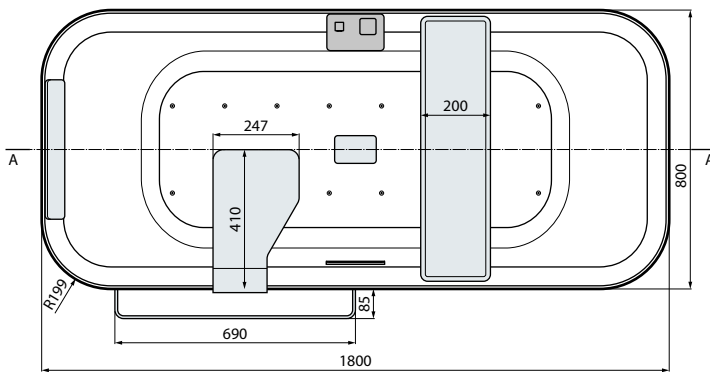
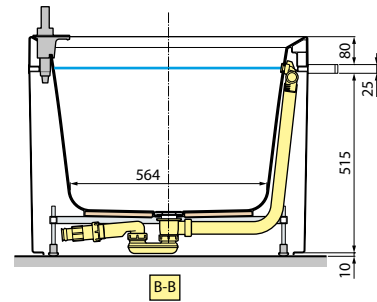
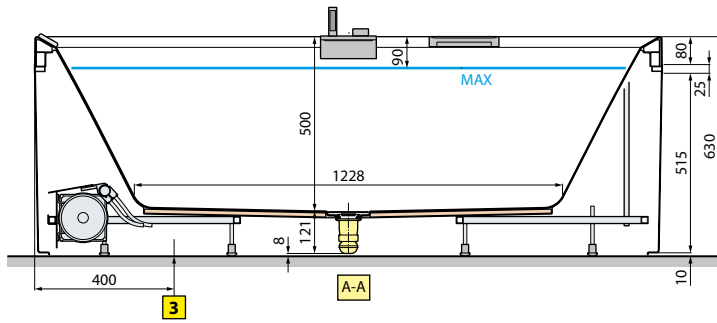

SÓLO PARA VERSIÓN PARA EMPOTRAR

Capacidad litros

300

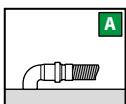

CARACTERÍSTICAS HIDRÁULICAS

- 16 jets Airpool
- Conexión del sifón de 1 1/2" /
Ligação sifão de 1 1/2"

CARACTERÍSTICAS ELÉCTRICAS

- Tensión: 220-230 V / Tensão: 220-230 V
- Frecuencia: 50 Hz / Frequência: 50 Hz
- Potencia máxima absorbida / Potencia
maxima absorbida:
Airpool 400 W

Debe instalarse un interruptor diferencial de 30 mA con una apertura mínima de los contactos igual a 3 mm. fabricado según la legislación vigente.

Deve instalar-se um interruptor diferencial de 30mA com uma abertura mínima dos contactos igual a 3 mm. Fabricado segundo as normas.

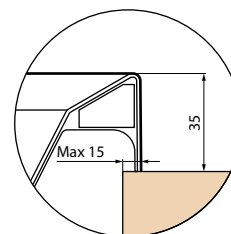
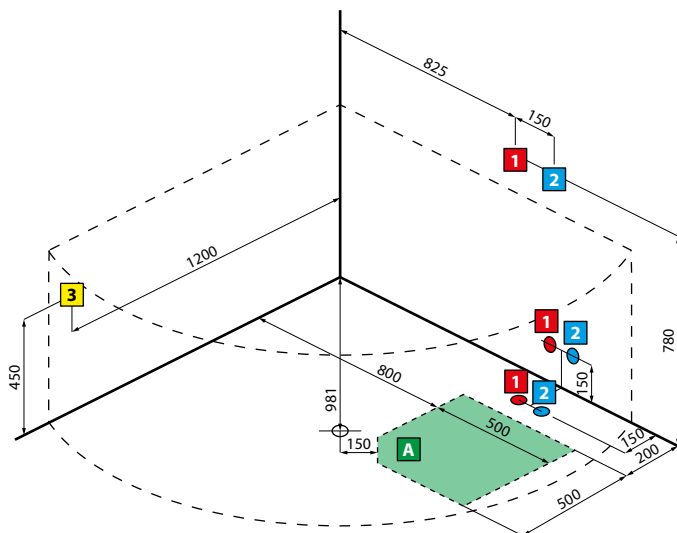
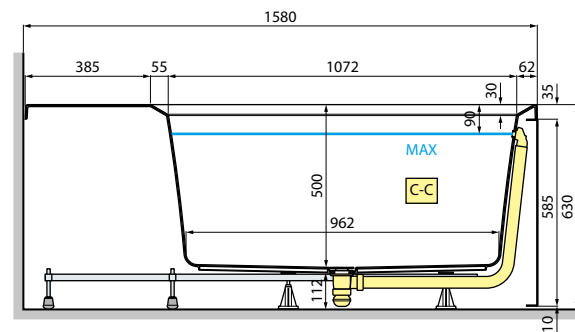
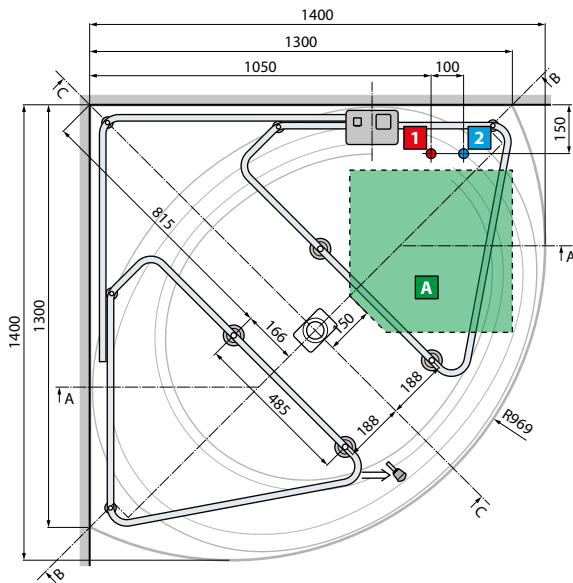
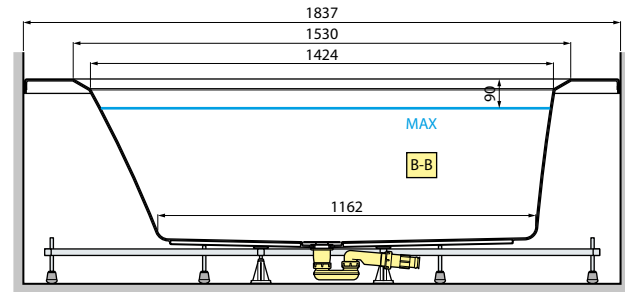
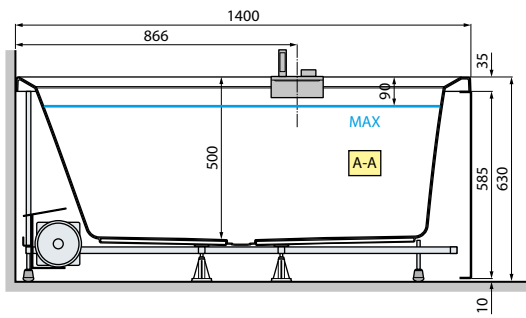

Capacidad litros

400

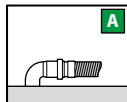

CARACTERÍSTICAS HIDRÁULICAS

- 16 jets Airpool
- Conexión del sifón de 1 1/2" /
Ligação sifão de 1 1/2"

CARACTERÍSTICAS ELÉCTRICAS

- Tensión: 220-230 V / Tensão: 220-230 V
- Frecuencia: 50 Hz / Freqüência: 50 Hz
- Potencia máxima absorbida / Potencia
maxima absorvida:
Whirlpool: 900 W
Airpool: 400 W
Plus: 1300 W
Natural Air: 1050 W

Debe instalarse un interruptor diferencial de 30 mA con una apertura mínima de los contactos igual a 3 mm. fabricado según la legislación vigente.

Deve instalar-se um interruptor diferencial de 30mA com uma abertura mínima dos contactos igual a 3 mm. Fabricado segundo as normas.

VERSIÓN IZQUIERDA / VERSÃO ESQUERDA

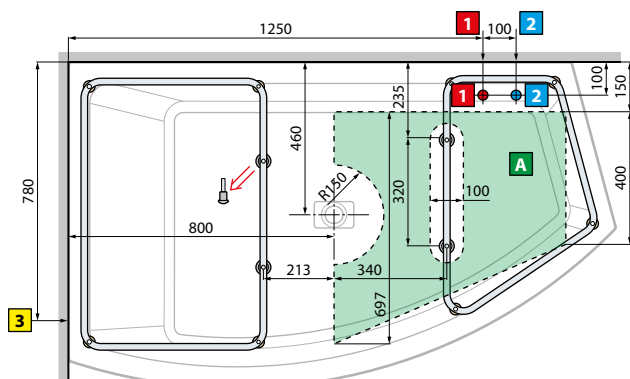
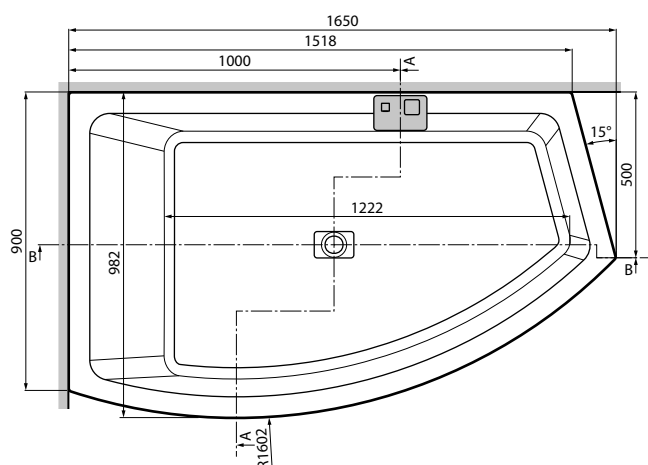
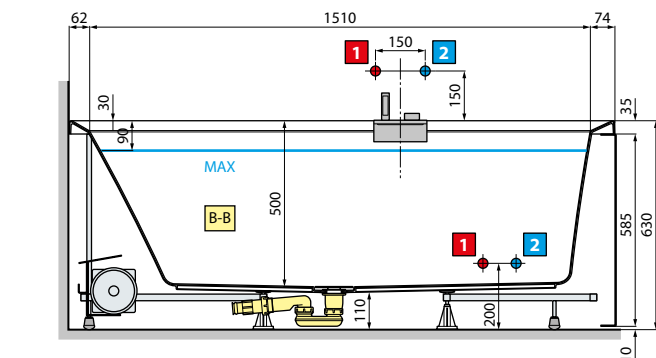

VERSIÓN DERECHA / VERSÃO DIREITA

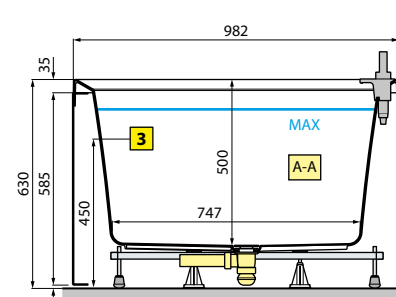
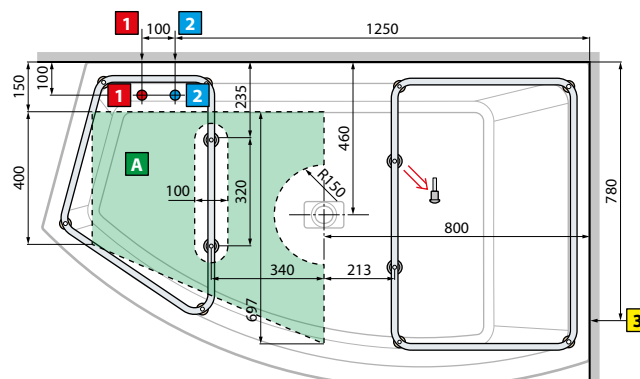
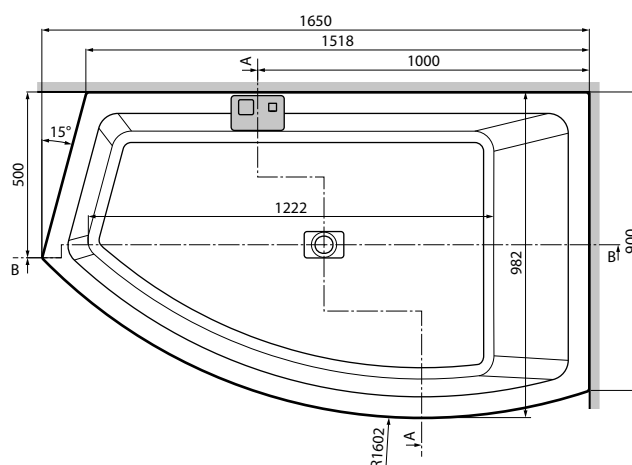
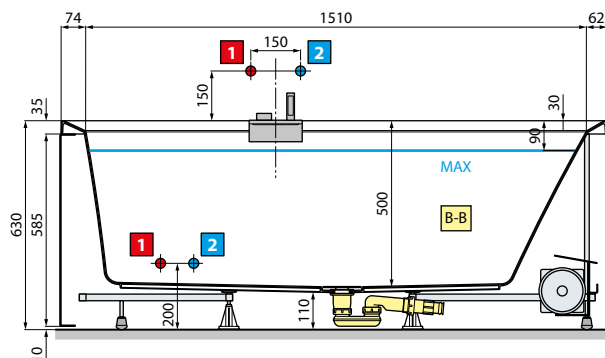

Capacidad litros

360

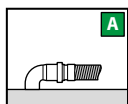
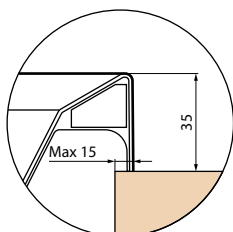

CARACTERÍSTICAS HIDRÁULICAS

- 16 jets Airpool
- Conexión del sifón de 1 1/2" / Ligaçao sifão de 1 1/2"

CARACTERÍSTICAS ELÉCTRICAS

- CARACTERÍSTICAS ELÉTRICAS**
- Tensión: 220-230 V / Tensão: 220-230 V
 - Frecuencia: 50 Hz / Frequência: 50 Hz
 - Potencia máxima absorbida / Potencia-maxima absorbida: Whirlpool: 900 W
Airpool: 400 W
Plus: 1300 W
Natural Air: 1050 W

Debe instalarse un interruptor diferencial de 30 mA con una apertura mínima de los contactos igual a 3 mm, fabricado según la legislación vigente.

Deve instalar-se um interruptor diferencial de 30mA com uma abertura mínima dos contactos igual a 3 mm. Fabricado segundo as normas.

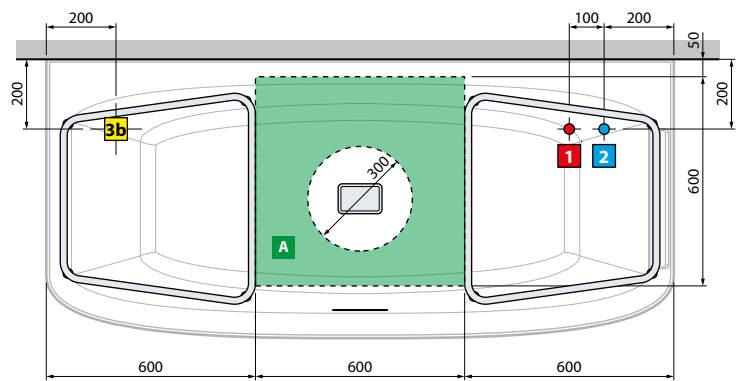
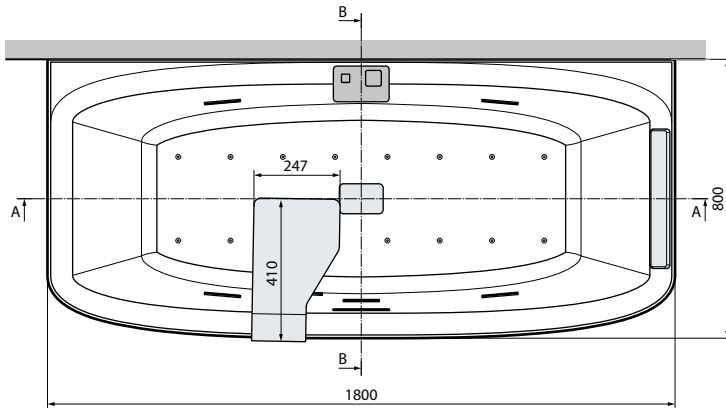
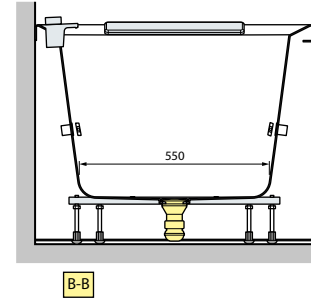
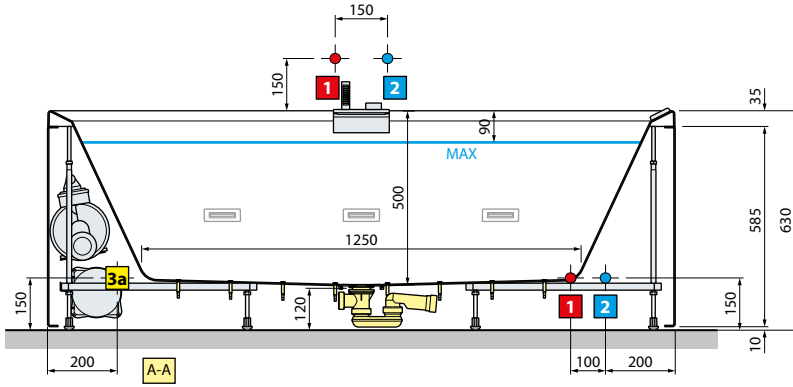

VERSIÓN IZQUIERDA / VERSÃO ESQUERDA

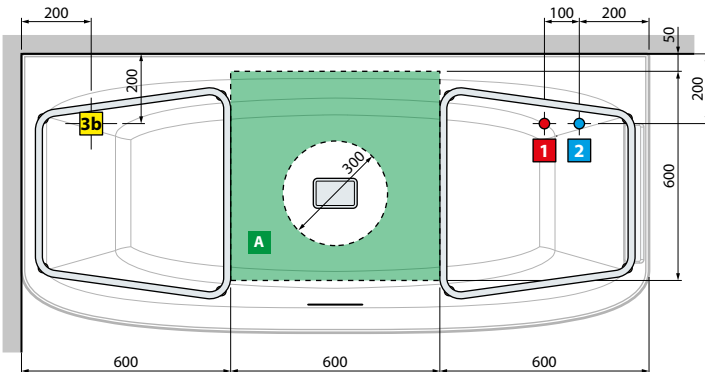

VERSIÓN DERECHA / VERSÃO DIREITA

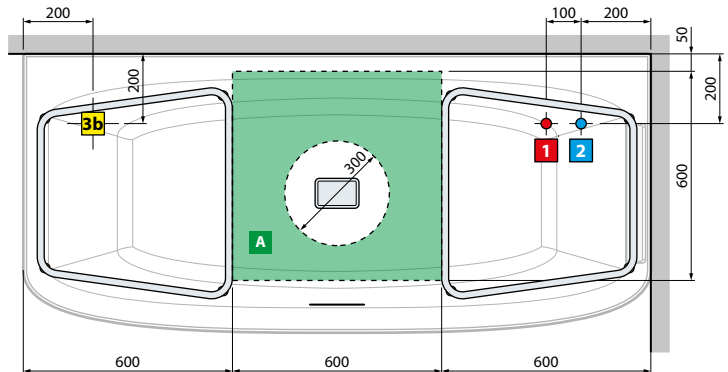

Capacidad litros

320

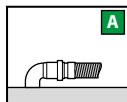

CARACTERÍSTICAS HIDRÁULICAS

16 jets airpool
6 jets whirlpool
Sifón con conexión de 1 1/2"

CARACTERÍSTICAS ELÉCTRICAS

Tensión: 220-230 V / Tensão: 220-230 V
Frecuencia: 50 Hz / Freqüência: 50 Hz
Potencia máxima absorbida / Potencia-máxima absorvida:
Whirlpool: 900 W
Airpool: 400 W
Plus: 1300 W
Natural Air: 1050 W

Debe instalarse un interruptor diferencial de 30 mA con una apertura mínima de los contactos igual a 3 mm. fabricado según la legislación vigente.

Deve instalar-se um interruptor diferencial de 30mA com uma abertura mínima dos contactos igual a 3 mm. Fabricado segundo as normas.



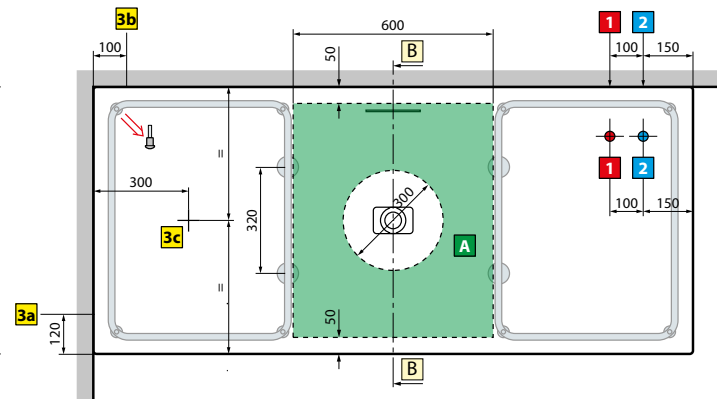
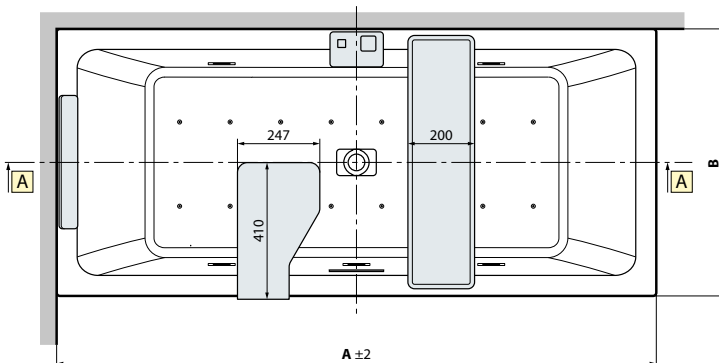
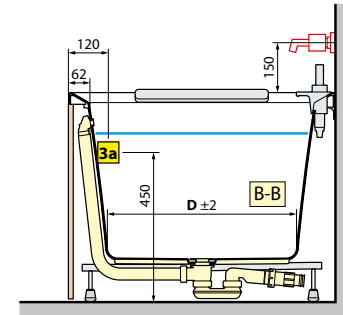
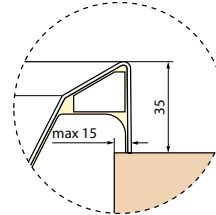
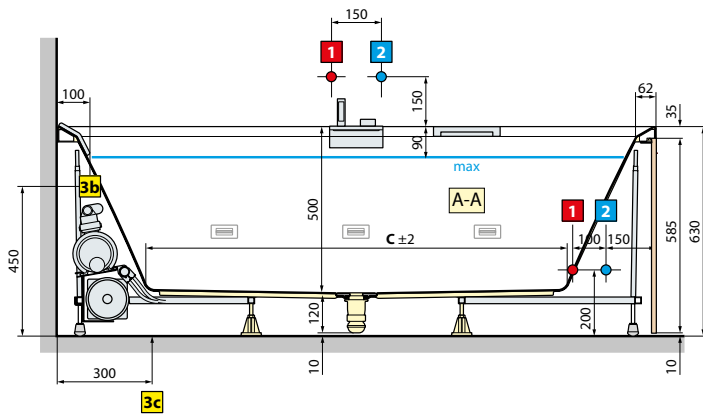

Modelo / Modéle	A	B	C	D	Capacidad litros
160x70	1600	700	1050	460	250
170x70	1700	700	1150	460	280
170x75	1700	750	1150	510	300
180x80	1800	800	1250	560	350
180x100	1800	1000	1250	760	430
190x90	1900	900	1350	660	420

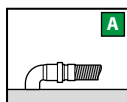

CARACTERÍSTICAS HIDRÁULICAS

16 jets airpool
6 jets whirlpool
Sifón con conexión de 1 1/2"

CARACTERÍSTICAS ELÉCTRICAS

CARACTERÍSTICAS ELÉCTRICAS
· Tensión: 220-230 V / Tensão: 220-230 V
· Frecuencia: 50 Hz / Freqüência: 50 Hz
· Potencia máxima absorbida /
Potencia máxima absorbida:
Whirlpool: 900 W
Airpool: 400 W
Plus: 1300 W
Natural Air: 1050 W

Debe instalar un interruptor diferencial de 30 mA con una apertura mínima de los contactos igual a 3 mm. fabricado según la legislación vigente.

Deve instalar-se um interruptor diferencial de 30 mA com uma abertura mínima dos contactos igual a 3 mm. fabricado segundo as normas.

DIVINA - MEDIDAS CON EL MARCO FRAME DATOS TÉCNICOS / DATOS TÉCNICOS

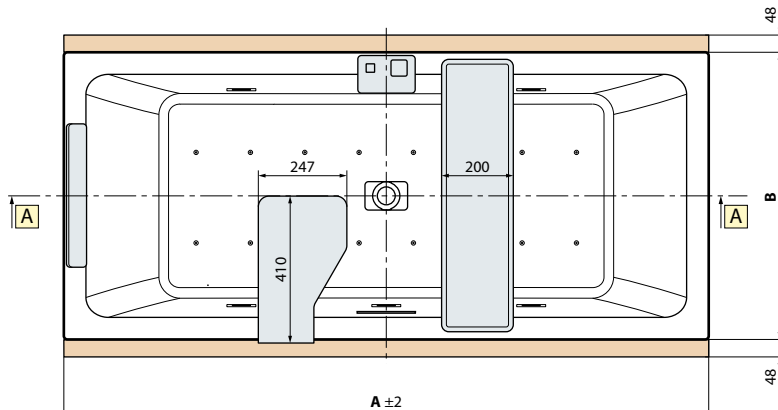
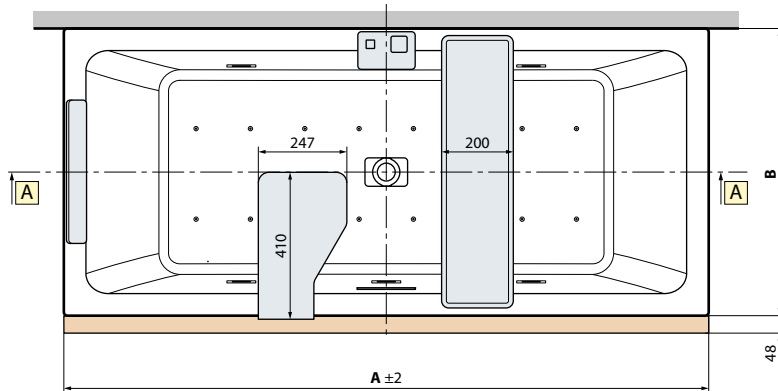
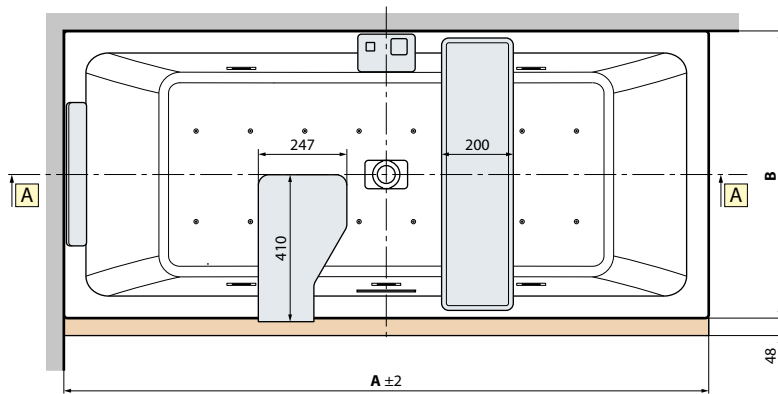
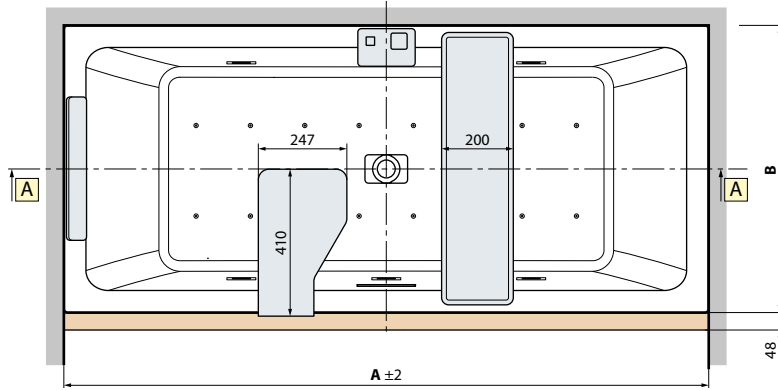
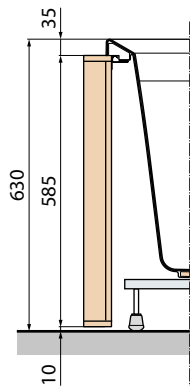
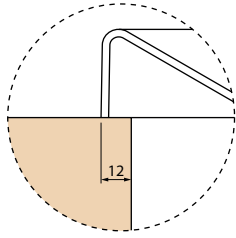

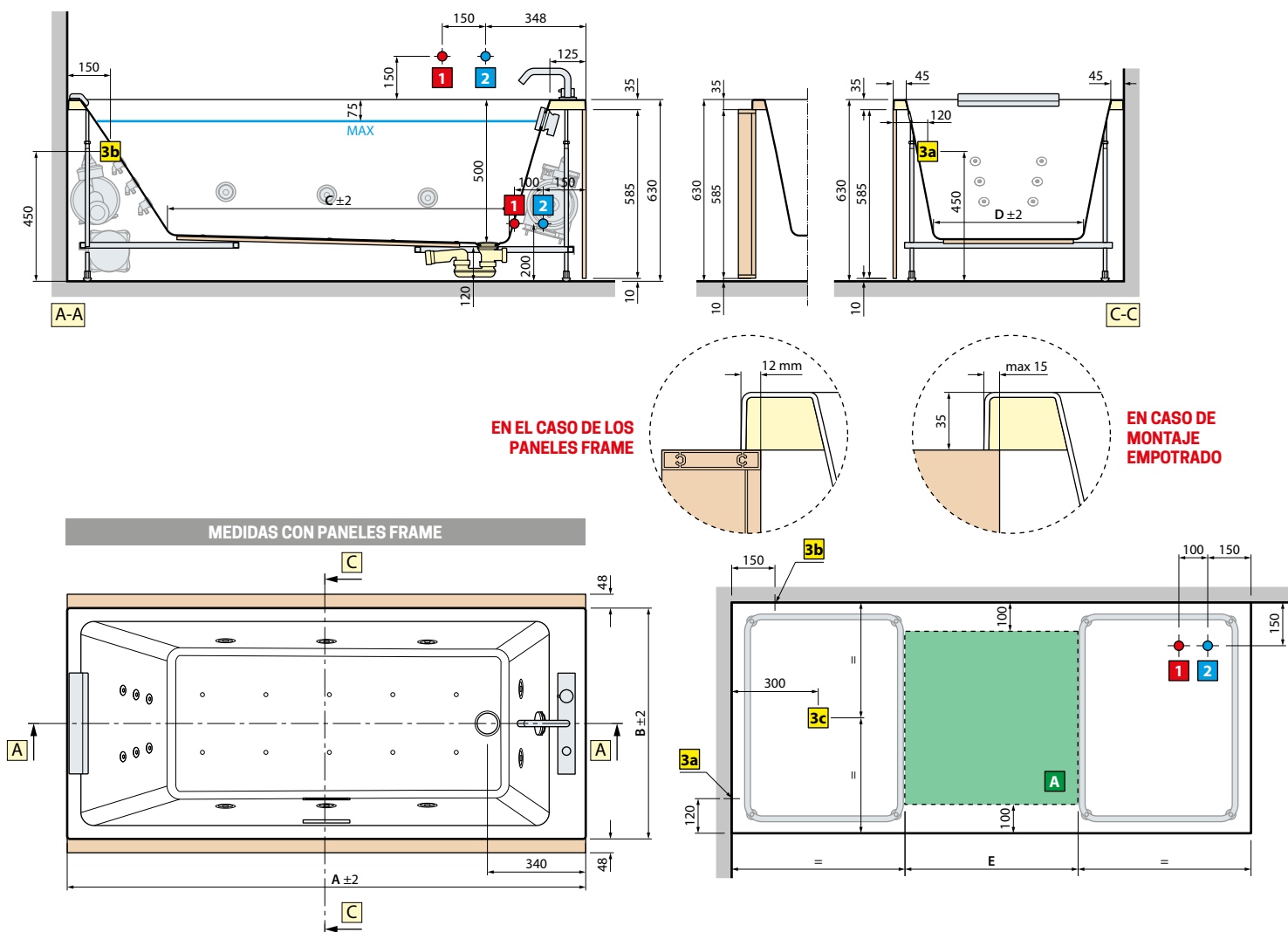

Modelo / Modéle	A	B	C	D	E	Capacidad litros
170x70	1700	700	1080	420	500	250
170x75	1700	750	1080	470	500	280
180x80	1800	800	1180	520	600	330
180x110	1800	1100	1180	820	600	500
190x90	1900	900	1280	620	600	410

POTENCIA ELÉCTRICA	HYDRO AIR	WHIRLPOOL	HYDRO PLUS	NATURAL AIR	WHIRLPOOL+ NATURAL AIR
	whirlpool		550 W	900 W	
airpool	400 W	—	400 W	—	—
natural air		—	—	1.050 W	1.050 W
TOTALE	400 W	550 W	1.300 W	1.050 W	1.050 W

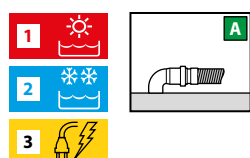

Debe instalarse un interruptor diferencial de 30 mA con una apertura mínima de los contactos igual a 3 mm. fabricado según la legislación vigente.

Deve instalar-se um interruptor diferencial de 30mA com uma abertura mínima dos contactos igual a 3 mm. Fabricado segundo as normas.

CARACTERÍSTICAS HIDRÁULICAS
 Conexión del sifón de 1 1/2" /
 Sifón con conexión de 1 1/2"

CARACTERÍSTICAS ELÉCTRICAS
CARACTERÍSTICAS ELÉTRICAS
 Tensão: 220-230 V
 Tensão: 220-230 V
 Frecuencia: 50 Hz
 Freqüência: 50 Hz

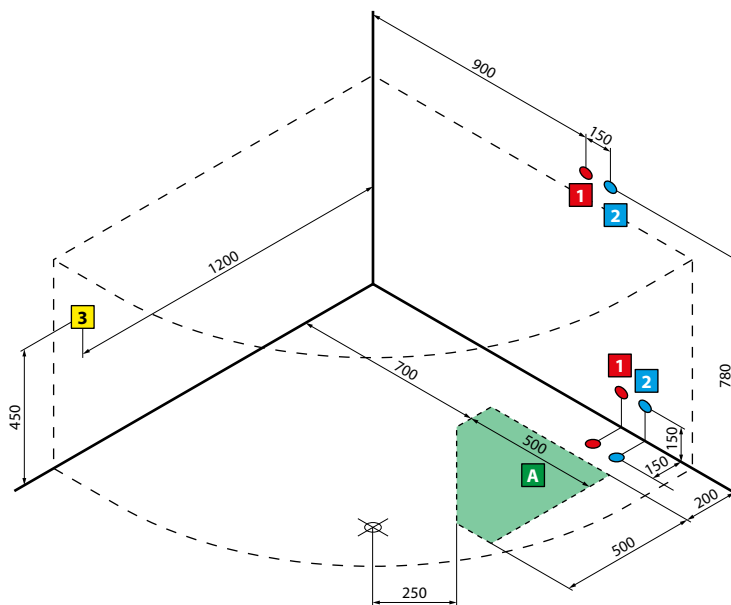
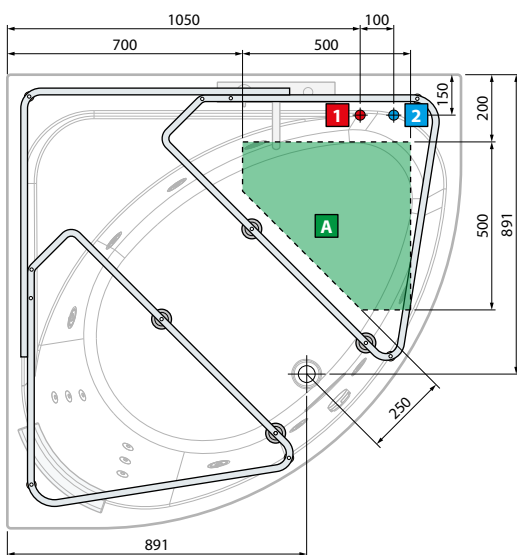
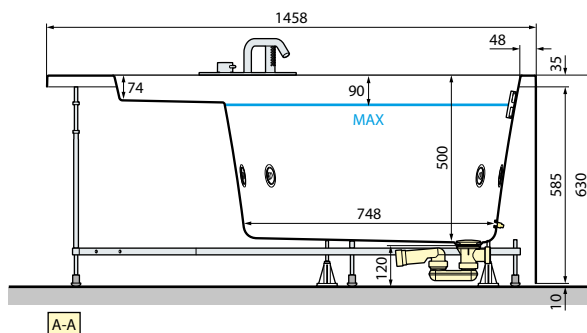
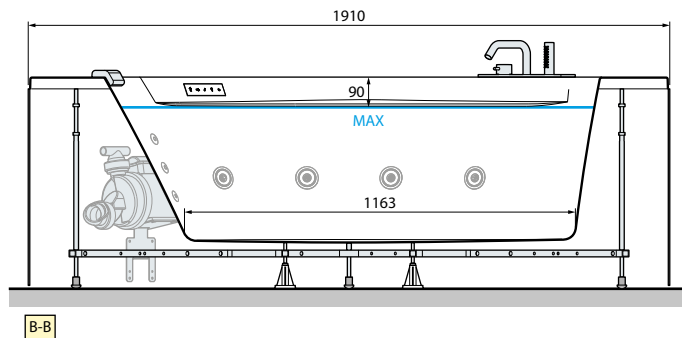
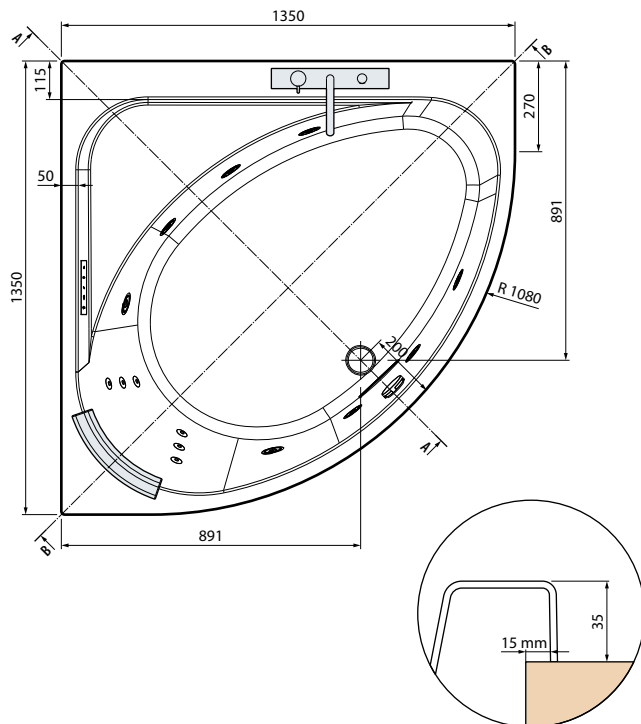

POTENCIA ELÉCTRICA

	HYDRO AIR	WHIRLPOOL	HYDRO PLUS	NATURAL AIR	WHIRLPOOL+NATURAL AIR
whirlpool		550 W	900 W		550 W
airpool	400 W	—	400 W	—	—
natural air		—	—	1.050 W	1.050 W
TOTALE	400 W	550 W	1.300 W	1.050 W	1.050 W

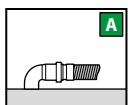

Debe instalarse un interruptor diferencial de 30 mA con una apertura mínima de los contactos igual a 3 mm. fabricado según la legislación vigente.

Deve instalar-se um interruptor diferencial de 30mA com uma abertura mínima dos contactos igual a 3 mm. Fabricado segundo as normas.

CARACTERÍSTICAS HIDRÁULICAS
 Conexión del sifón de 1 1/2" /
 Sifón con conexión de 1 1/2"

CARACTERÍSTICAS ELÉCTRICAS
CARACTERÍSTICAS ELÉTRICAS
 Tensión: 220-230 V
 Tensão: 220-230 V
 Frecuencia: 50 Hz
 Freqüência: 50 Hz

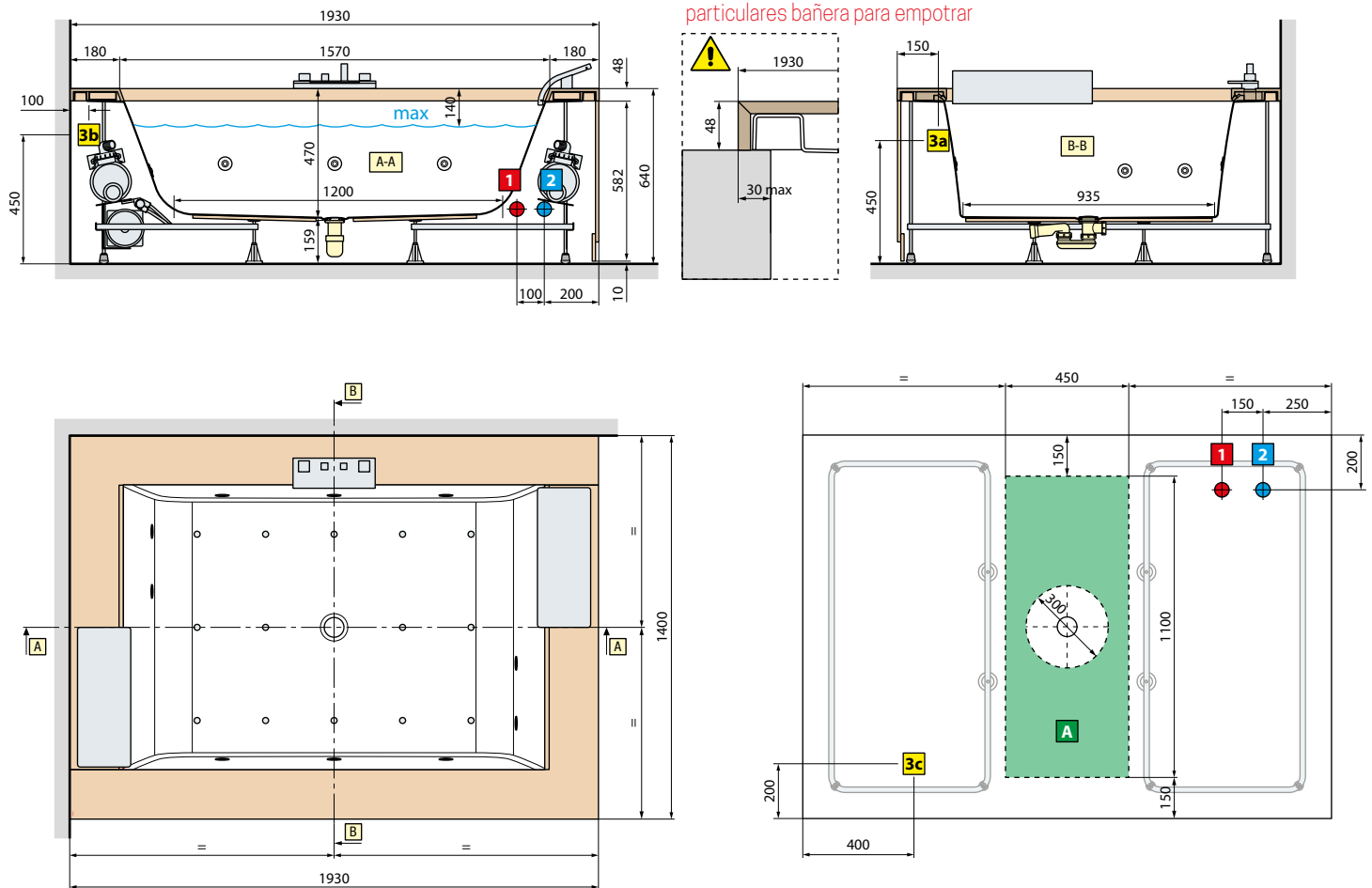

Capacidad litros

450

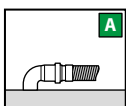

ATENCIÓN!! Puede ser perjudicial para las personas que utilizan marcapasos
ATENÇÃO!! Pode ser prejudicial para pessoas que usem pacemaker

Debe instalarse un interruptor diferencial de 30 mA con una apertura mínima de los contactos igual a 3 mm. fabricado según la legislación vigente.

Deve instalar-se um interruptor diferencial de 30mA com uma abertura mínima dos contactos igual a 3 mm. Fabricado segundo as normas.

CARACTERÍSTICAS HIDRÁULICAS

- 10 jets Whirlpool
- 14 jets Airpool
- Conexión del sifón de 1 1/2" / Sifón con conexión de 1 1/2"

CARACTERÍSTICAS ELÉCTRICAS

- CARACTERÍSTICAS ELÉTRICAS**
- Tensión: 220-230 V / Tensão: 220-230 V
 - Frecuencia: 50 Hz / Frequência: 50 Hz
 - Potencia máxima absorbida / Potencia maxima absorvida: 2950 W
 - Calentador: 1450 W
 - Whirlpool: 550+550 W
 - Airpool: 400 W

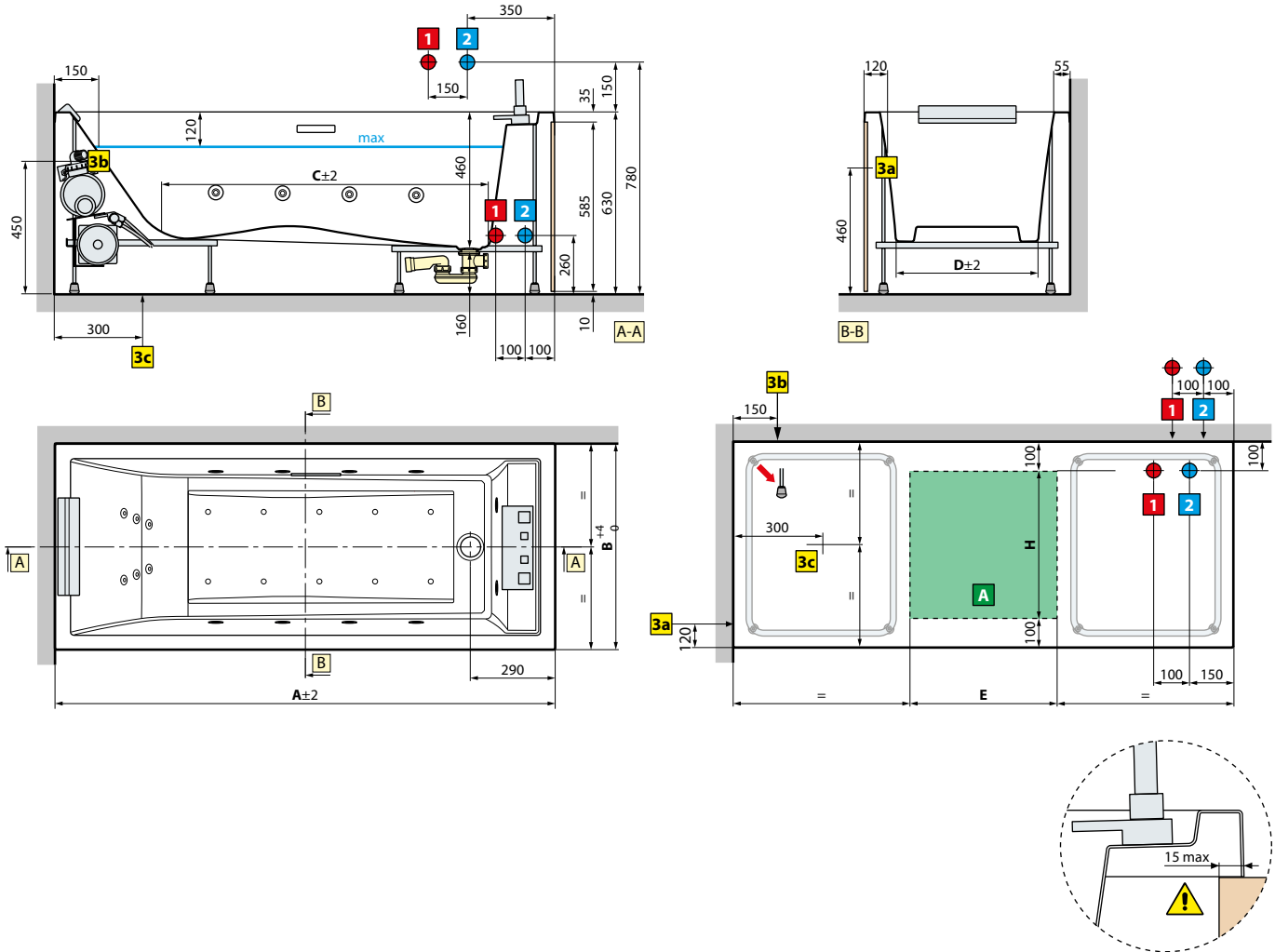

Modelo / Modéle	A	B	C	D	E	Capacidad litros
170x70	1700	700	1107	475	500	205
170x75	1700	750	1107	525	500	225
180x80	1800	800	1142	575	600	250
190x80	1900	800	1173	575	700	265

	POTENCIA ELÉCTRICA				
	HYDRO AIR	WHIRLPOOL + DISINFEZIONE	WHIRLPOOL DISINFEZIONE + LIGHT	HYDRO PLUS	WHIRLPOOL + NATURAL AIR
calentador	—	—	—	1.300 W	—
whirlpool	—	550 W	550 W	900 W	550 W
airpool	400 W	—	—	400 W	—
natural air	—	—	—	—	1.050 W
TOTALE	400 W	550 W	550 W	2.600 W	1.050 W

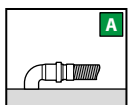

Debe instalarse un interruptor diferencial de 30 mA con una apertura mínima de los contactos igual a 3 mm. fabricado según la legislación vigente.

Deve instalar-se um interruptor diferencial de 30mA com uma abertura mínima dos contactos igual a 3 mm. Fabricado segundo as normas.

CARACTERÍSTICAS HIDRÁULICAS

Conexión del sifón de 1 1/2"
Ligação sifão de 1 1/2"

CARACTERÍSTICAS ELÉCTRICAS

CARACTERÍSTICAS ELÉTRICAS

Tensión: 220-230 V
Tensão: 220-230 V
Frecuencia: 50 Hz
Frequência: 50 Hz

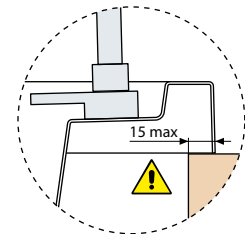
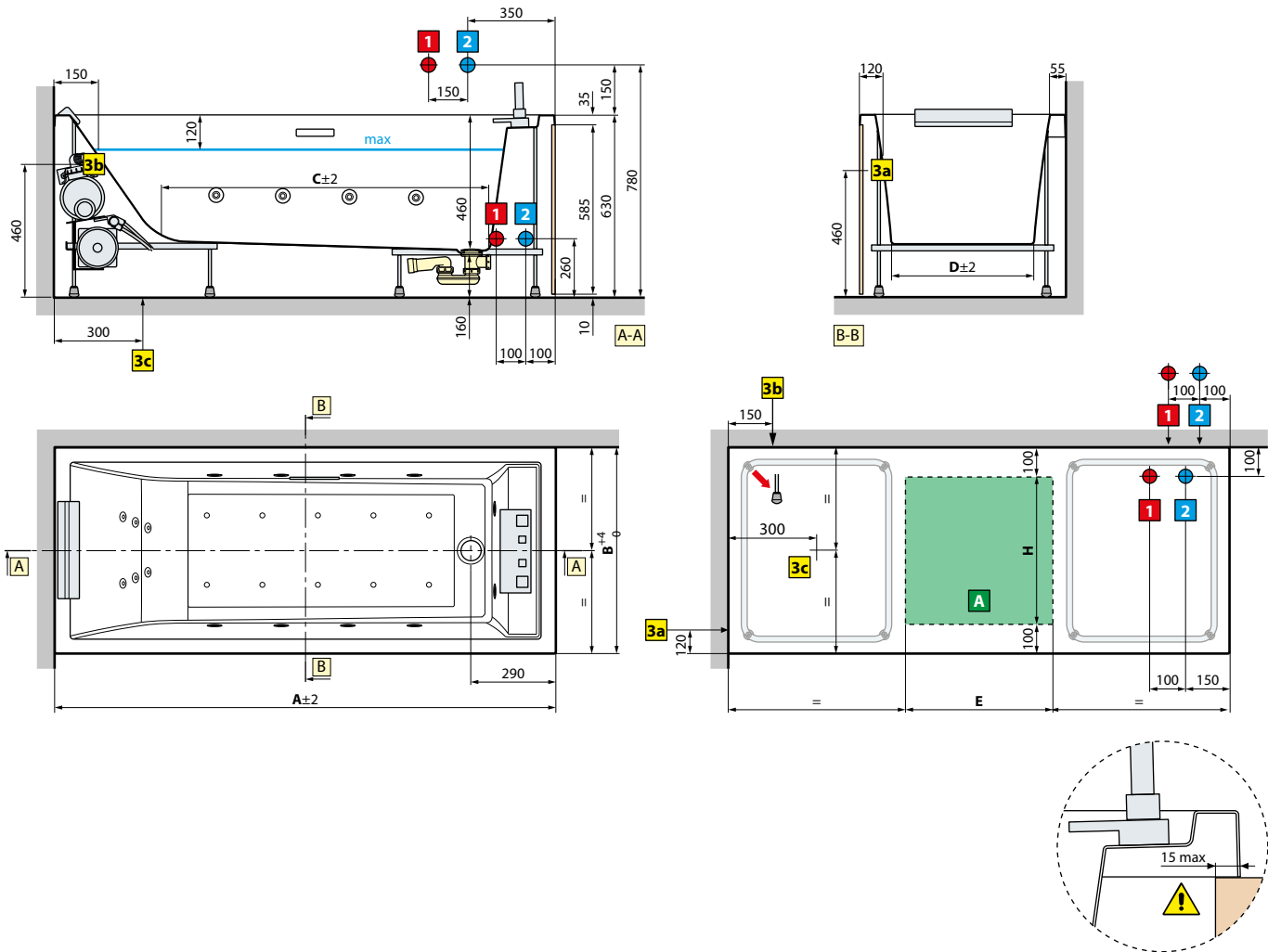

Modelo / Modéle	A	B	C	D	E	Capacidad litros
170x70	1700	700	1107	475	500	215
170x75	1700	750	1107	525	500	235
180x80	1800	800	1142	575	600	265
190x80	1900	800	1173	575	700	280

POTENCIA ELÉCTRICA

	HYDRO AIR	WHIRLPOOL + DISINFEZIONE	WHIRLPOOL DISINFEZIONE + LIGHT	HYDRO PLUS	WHIRLPOOL + NATURAL AIR
calentador	—	—	—	1.300 W	—
whirlpool	—	550 W	550 W	900 W	550 W
airpool	400 W	—	—	400 W	—
natural air	—	—	—	—	1.050 W
TOTALE	400 W	550 W	550 W	2.600 W	1.050 W

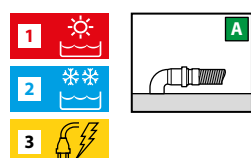

Debe instalarse un interruptor diferencial de 30 mA con una apertura mínima de los contactos igual a 3 mm. fabricado según la legislación vigente.

Deve instalar-se um interruptor diferencial de 30mA com uma abertura mínima dos contactos igual a 3 mm. Fabricado segundo as normas.

CARACTERÍSTICAS HIDRÁULICAS
 Conexión del sifón de 1 1/2"
 Ligaçõ sifão de 1 1/2"

CARACTERÍSTICAS ELÉCTRICAS
CARACTERÍSTICAS ELÉTRICAS
 Tensión: 220-230 V
 Tensão: 220-230 V
 Frecuencia: 50 Hz
 Frequência: 50 Hz

DATOS TÉCNICOS / DADOS TÉCNICOS

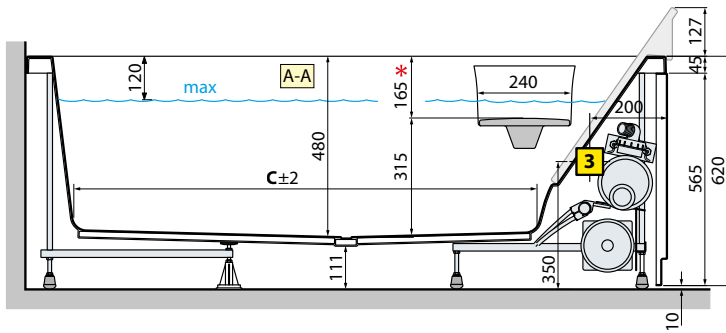

* 145 mm para el modelo 160x70/80

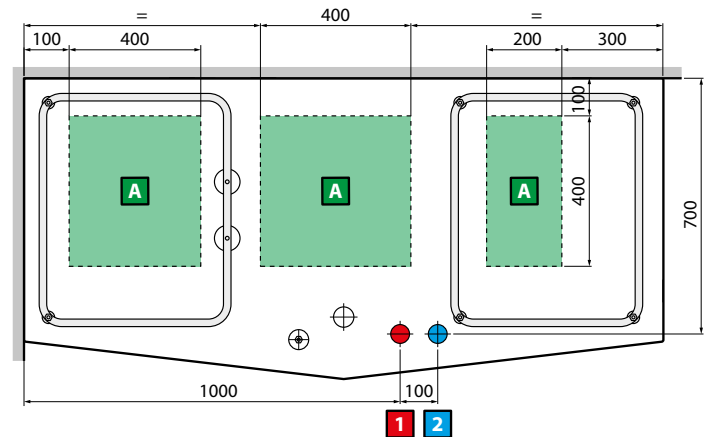
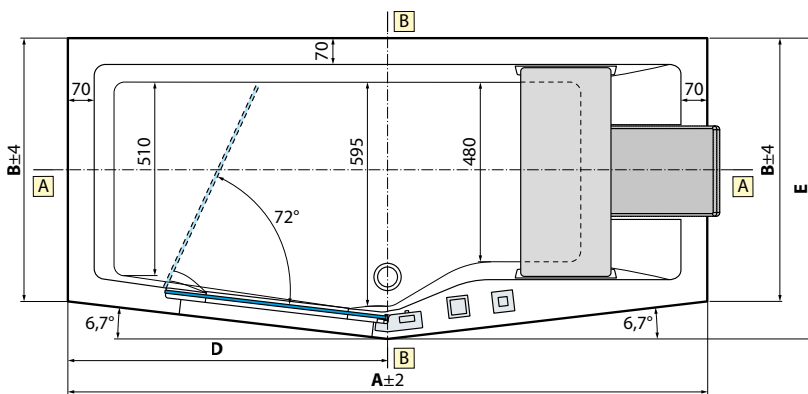
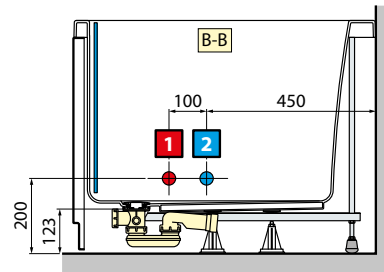
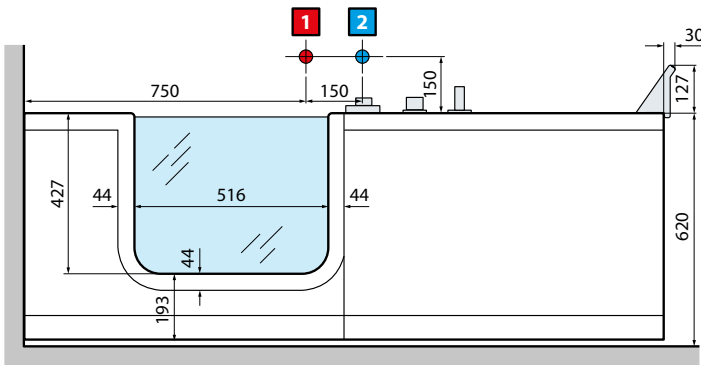

Modelo / Modéle	A	B	C	D	E	Capacidad litros
160x70/80	1600	700	1140	860	800	250
170x70/80	1700	700	1235	850	800	265
180x75/85	1800	750	1345	860	850	305

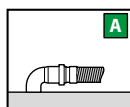
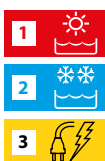

ATENCIÓN!! Puede ser perjudicial para las personas que utilizan marcapasos
ATENÇÃO!! Pode ser prejudicial para pessoas que usem pacemaker

Debe instalarse un interruptor diferencial de 30 mA con una apertura mínima de los contactos igual a 3 mm. fabricado según la legislación vigente.

Deve instalar-se um interruptor diferencial de 30mA com uma abertura mínima dos contactos igual a 3 mm. Fabricado segundo as normas.

CARACTERÍSTICAS HIDRÁULICAS

- 6 jets Whirlpool
- 16 jets Airpool
- Conexión del sifón de 1 1/2" / Ligaçao sifão de 1 1/2"

CARACTERÍSTICAS ELÉCTRICAS

- Tensión: 220-230 V / Tensão: 220-230 V
- Frecuencia: 50 Hz / Frequência: 50 Hz
- Potencia máxima absorbida / Potencia maxima absorbida: 950 W
- Whirlpool: 550 W
- Airpool: 400 W

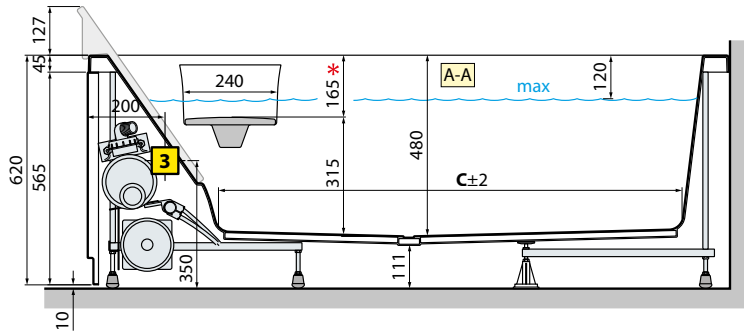

* 145 mm para el modelo 160x70/80

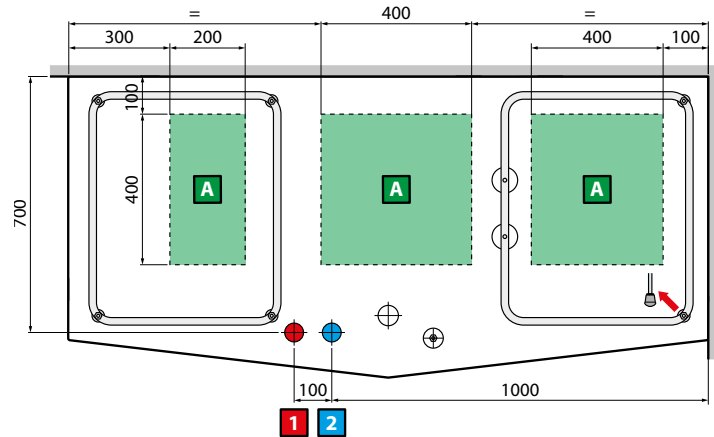
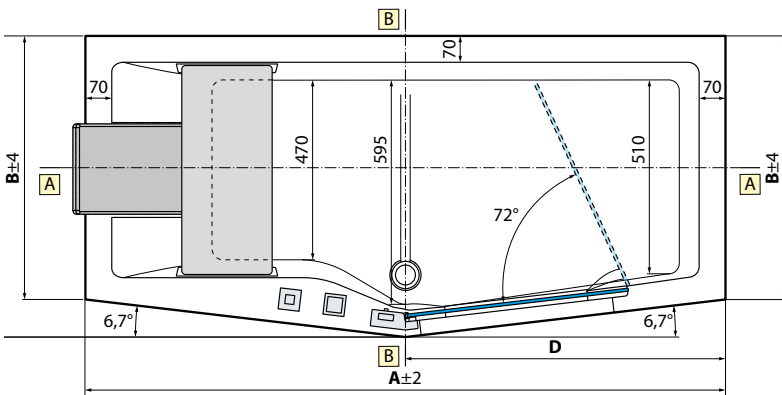
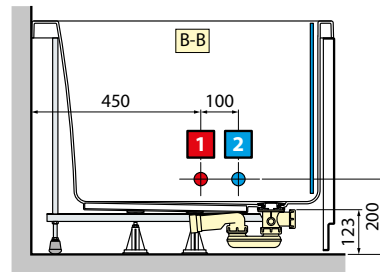
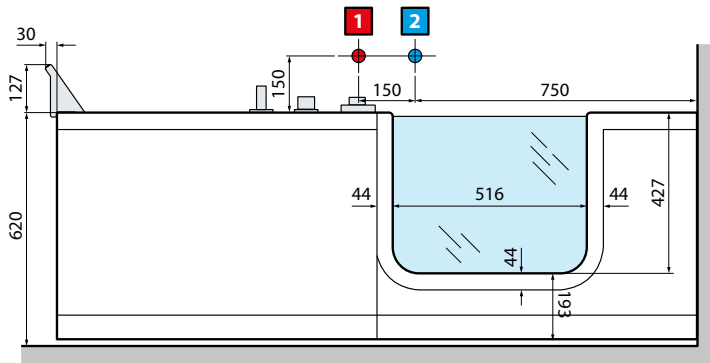

Modelo / Modéle	A	B	C	D	E	Capacidad litros
160x70/80	1600	700	1140	860	800	250
170x70/80	1700	700	1235	850	800	265
180x75/85	1800	750	1345	860	850	305

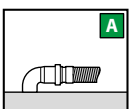

ATENCIÓN!! Puede ser perjudicial para las personas que utilizan marcapasos
ATENÇÃO!! Pode ser prejudicial para pessoas que usem pacemaker

Debe instalarse un interruptor diferencial de 30 mA con una apertura mínima de los contactos igual a 3 mm. fabricado según la legislación vigente.

Deve instalar-se um interruptor diferencial de 30mA com uma abertura mínima dos contactos igual a 3 mm. Fabricado segundo as normas.

CARACTERÍSTICAS HIDRÁULICAS

- 6 jets Whirlpool
- 16 jets Airpool
- Conexión del sifón de 1 1/2" / Ligação sifão de 1 1/2"

CARACTERÍSTICAS ELÉCTRICAS

CARACTERÍSTICAS ELÉTRICAS

- Tensión: 220-230 V / Tensão: 220-230 V
- Frecuencia: 50 Hz / Freqüência: 50 Hz
- Potencia máxima absorbida / Potencia maxima absorvida: 950 W
- Whirlpool: 550 W
- Airpool: 400 W

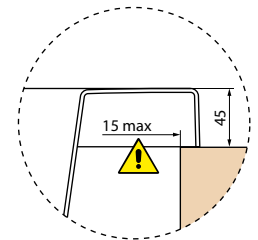
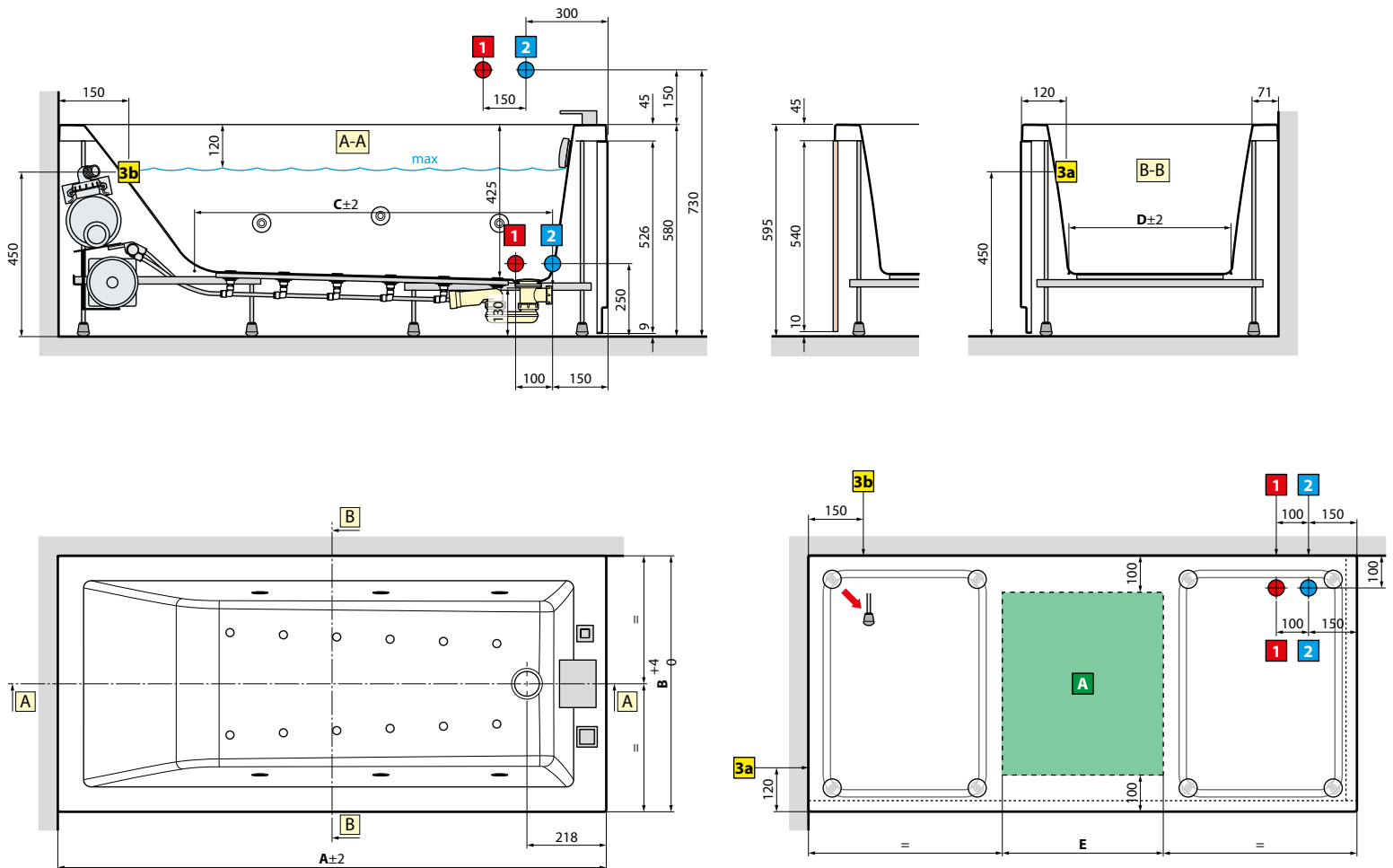

Modelo / Modéle	A	B	C	D	E	Capacidad litros
150x70	1500	700	979	444	300	150
160x70	1600	700	1081	444	400	170
170x70	1700	700	1183	444	500	185
170x75	1700	750	1183	494	500	200
170x80	1700	800	1183	544	500	215
180x80	1800	800	1285	544	600	235

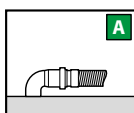

ATENCIÓN!! Puede ser perjudicial para las personas que utilizan marcapasos
ATENÇÃO!! Pode ser prejudicial para pessoas que usam pacemaker

Debe instalarse un interruptor diferencial de 30 mA con una apertura mínima de los contactos igual a 3 mm. fabricado según la legislación vigente.

Deve instalar-se um interruptor diferencial de 30mA com uma abertura mínima dos contactos igual a 3 mm. Fabricado segundo as normas.

CARACTERÍSTICAS HIDRÁULICAS

- 6 jets Whirlpool
- 12 jets Airpool
- Conexión del sifón de 1 1/2" /
Ligação sifão de 1 1/2"

CARACTERÍSTICAS ELÉCTRICAS

- Tensión: 220-230 V / Tensão: 220-230 V
- Frecuencia: 50 Hz / Freqüência: 50 Hz
- Potencia máxima absorbida / Potencia-maxima absorvida: 950 W
- Whirlpool: 550 W
- Airpool: 400 W

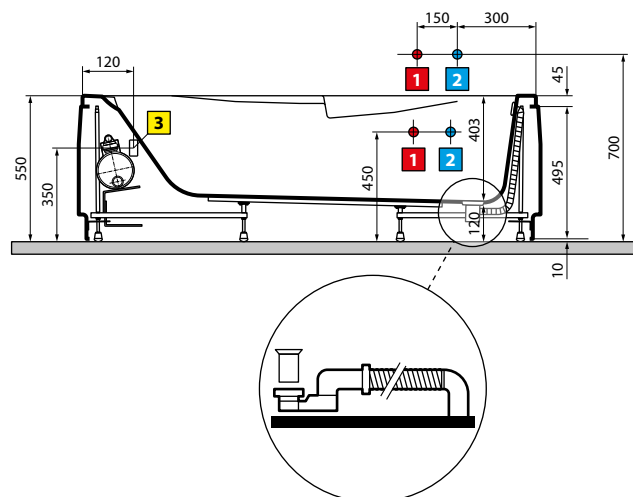
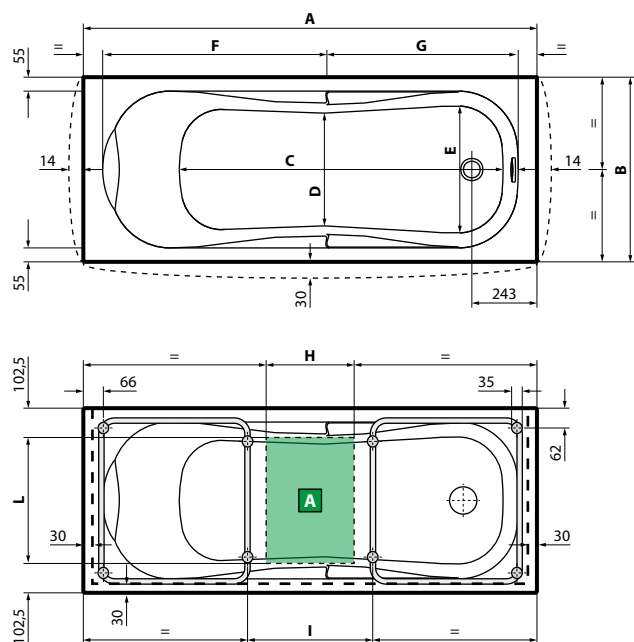

Modelo / Modéle	A	B	C	D	E	F	G	H	I	L	Capacidad litros
150x70	1495	695	1000	420	470	730	625	290	412,5	490	150
160x70	1595	695	1100	420	470	780	675	390	512	490	160
w170x70	1695	695	1200	420	470	830	725	490	611,5	490	170
170x75	1695	745	1200	470	520	830	725	370	491,5	540	180
170x80	1695	795	1200	500	570	830	725	400	535	590	190
180x80	1795	795	1300	500	570	880	775	500	631,5	590	200

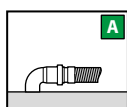

ATENCIÓN!! Puede ser perjudicial para las personas que utilizan marcapasos
ATENÇÃO!! Pode ser prejudicial para pessoas que usem pacemaker

Debe instalarse un interruptor diferencial de 30 mA con una apertura mínima de los contactos igual a 3 mm. fabricado según la legislación vigente.

Deve instalar-se um interruptor diferencial de 30mA com uma abertura mínima dos contactos igual a 3 mm. Fabricado segundo as normas.

CARACTERÍSTICAS HIDRÁULICAS

- 5/7 jets Whirlpool
- 12 jets Airpool
- Conexión del sifón de 1 1/2" /
Ligação sifão de 1 1/2"

CARACTERÍSTICAS ELÉCTRICAS

- Tensión: 220-230 V / Tensão: 220-230 V
- Frecuencia: 50 Hz / Freqüência: 50 Hz
- Potencia máxima absorbida / Potencia-maxima absorvida: 950 W
Whirlpool: 550 W
Airpool: 400 W

VERSIÓN IZQUIERDA / VERSÃO ESQUERDA

VERSIÓN DERECHA / VERSÃO DIREITA

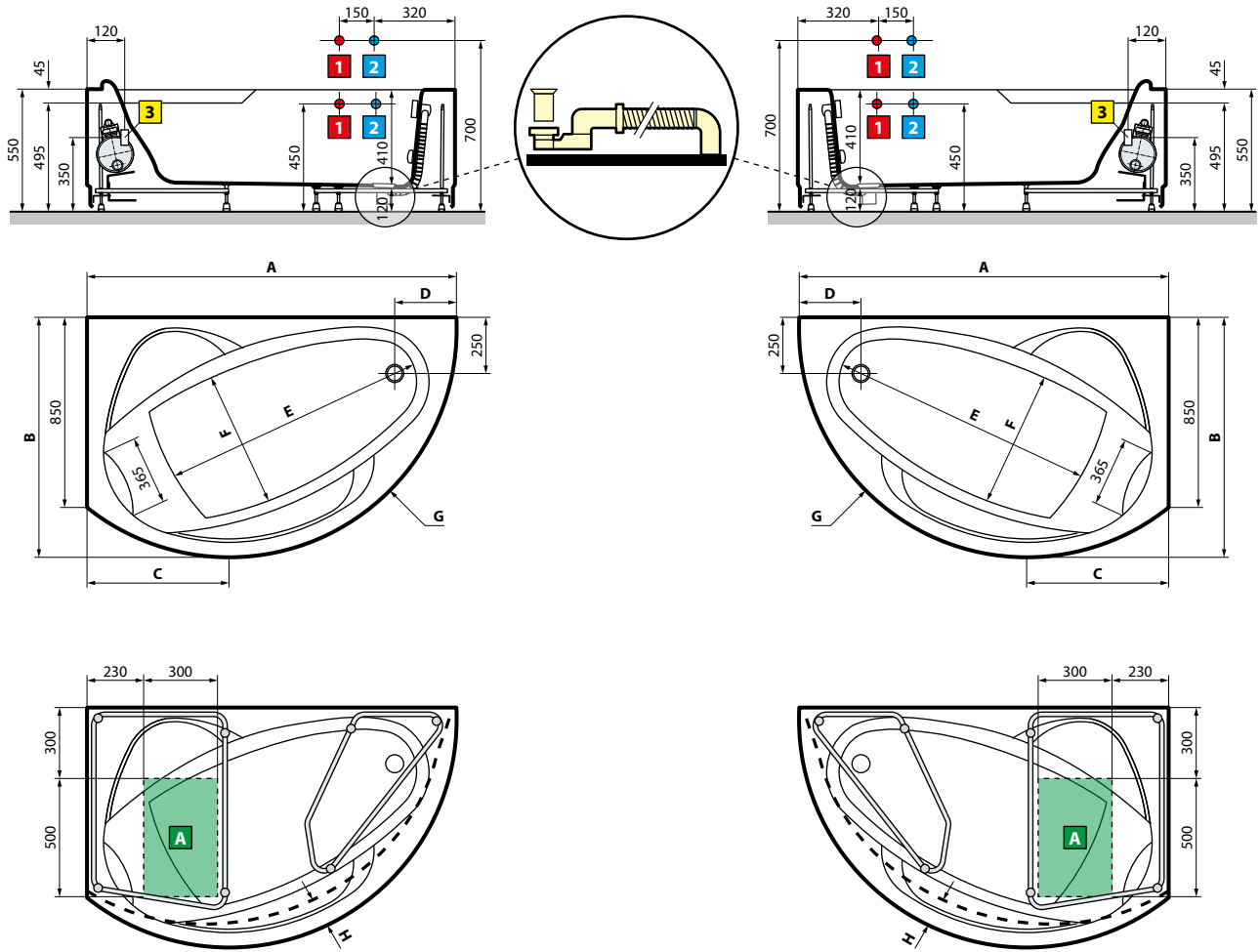

Modelo / Modéle	A	B	C	D	E	F	G	H	Capacidad litros
150x85	1500	1015	550	290	1030	580	962	137	140
165x85	1650	1070	630	280	1150	640	1015	155	180

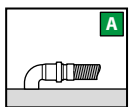

ATENCIÓN!! Puede ser perjudicial para las personas que utilizan marcapasos
ATENÇÃO!! Pode ser prejudicial para pessoas que usem pacemaker

Debe instalarse un interruptor diferencial de 30 mA con una apertura mínima de los contactos igual a 3 mm. fabricado según la legislación vigente.

Deve instalar-se um interruptor diferencial de 30mA com uma abertura mínima dos contactos igual a 3 mm. Fabricado segundo as normas.

CARACTERÍSTICAS HIDRÁULICAS

- 5/7 jets Whirlpool
- 12 jets Airpool
- Conexión del sifón de 1 1/2" /
Ligação sifão de 1 1/2"

CARACTERÍSTICAS ELÉCTRICAS
CARACTERÍSTICAS ELÉTRICAS

- Tensión: 220-230 V / Tensão: 220-230 V
- Frecuencia: 50 Hz / Freqüência: 50 Hz
- Potencia máxima absorbida / Potencia-maxima absorvida: 950 W
Whirlpool: 550 W
Airpool: 400 W

BABY

DATOS TÉCNICOS / DADOS TÉCNICOS

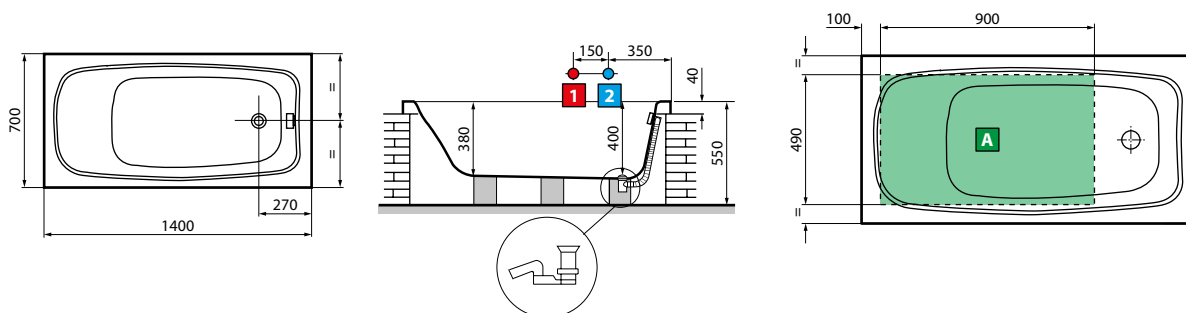

Capacidad litros

100



CARACTERÍSTICAS HIDRÁULICAS

· Conexión del sifón de 1 1/2" /
Ligação sifão de 1 1/2"

BABY TWO

DATOS TÉCNICOS / DADOS TÉCNICOS

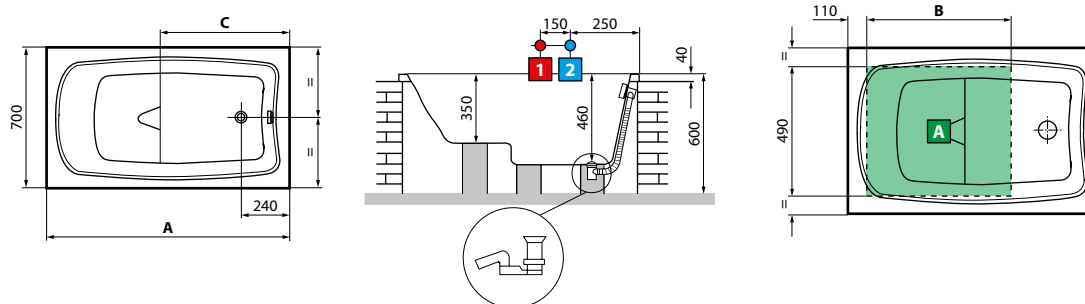

Modelo / Modéle	A	B	C	Capacidad litros
105x70	1050	570	570	61
120x70	1200	720	640	81



CARACTERÍSTICAS HIDRÁULICAS

· Conexión del sifón de 1 1/2" /
Ligação sifão de 1 1/2"





ACCESORIOS ACESSÓRIOS

EL PERFECTO
COMPLEMENTO
PARA EL BAÑO.

O PERFEITO
COMPLEMENTO
PARA A CASA
DE BANHO.

La gama Novellini incluye una amplia selección de accesorios para su ducha, cabina o bañera. Taburetes y asientos de ducha, toalleros de pie y pared, limpia cristales, agarraderos de seguridad y cestos de ducha de alambre o acero inoxidable con bandeja. Todo lo que necesita para hacer de su baño la solución de estilo perfecta para sus necesidades.

A gama Novellini, inclui uma ampla selecção de acessórios para o seu duche, cabina ou banheira. Bancos ou assentos de duche, toalheiros de pé e parede, limpa vidros, apoios á parede de segurança, saboneteiras em arame ou aço inox com bandeja. Tudo o que necessita para fazer do seu banho a solução perfeita ás suas necessidades



X 12 cm
Y 76 cm
Z 9/10 cm

DOS REPISAS INTERIORES + ESPACIO PARA LIMPIACRISTALES Y PERCHA EXTERIOR PARA COLGAR SOBRE CRISTAL

(limpiacristales no incluido)



Medidas (cm)	Código	Selección de acabados/Precio		
		U	B	H
12 x 76	R90AKFP01290-	Blanco mate Branco mate	Silver Abrillantado	Negro mate
		+ 106 zł	+ 117 zł	+ 128 zł



X 35 cm
Y 90 cm
Z 8,5/8,5 cm

REPISA INTERIOR Y TOALLERO EXTERIOR PARA COLGAR SOBRE EL CRISTAL



Medidas (cm)	Código	Selección de acabados/Precio		
		U	B	H
35 x 90	R90AKFPSP03590-	Blanco mate Branco mate	Silver Abrillantado	Negro mate
		255 €	276 €	297 €



X 35 cm
Y 90 cm
Z 8,5 cm

TRIPLE REPISA INTERIOR Y PERCHA PARA TOALLA EXTERNA. COLOCACIÓN SOBRE EL CRISTAL



Medidas (cm)	Código	Selección de acabados/Precio		
		U	B	H
35 x 90	R90AKFP03590-	Blanco mate Branco mate	Silver Abrillantado	Negro mate
		234 €	250 €	265 €



REPISA INTERIOR Y PERCHA PARA TOALLA EXTERIOR. COLOCACIÓN SOBRE EL CRISTAL



Blanco Silver Negro
Branco Abrillatado mate

Medidas (cm)	Código	Selección de acabados/Precio		
		U	B	H
		Blanco mate Branco mate	Silver Abrillatado	Negro mate
40 x 60	R90AKFPO4070-	96 €	101 €	106 €

X 70 cm
Y 40 cm
Z 8,5 cm



REPISA



Blanco Silver Negro
Branco Abrillatado mate

Medidas (cm)	Código	Selección de acabados/Precio		
		U	B	H
		Blanco mate Branco mate	Silver Abrillatado	Negro mate
9,7 x 17,5	R90AKFME17-	64	69	75
9,7 x 30	R90AKFME30-	69	75	80
9,7 x 45	R90AKFME45-	75	80	85

X 17,5/30/45 cm
Y 1,2 cm
Z 9,7 cm

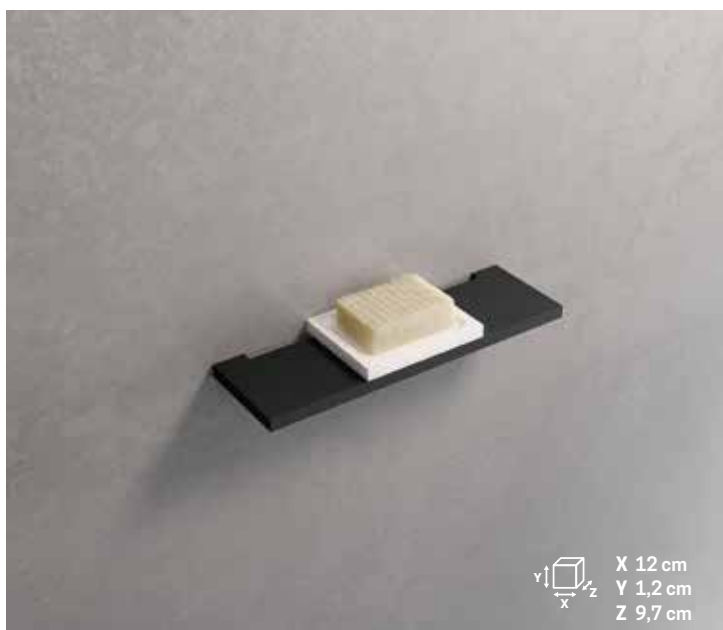

SOPORTE PARA JABÓN (repisa no incluida)



Blanco
Branco

Medidas (cm)	Código	Selección de acabados/Precio
		U
		Blanco mate Branco mate
9,7 x 12	R90AKFBS01-	43 €

X 12 cm
Y 1,2 cm
Z 9,7 cm



X 30 cm
Y 1,2 cm
Z 9,7 cm

◀ **REPISA CON SOPORTE PARA LIMPIACRISTALES**



Medidas (cm)	Código	Selección de acabados/Precio		
		U	B	H
		Blanco mate Branco mate	Silver Abrillatado	Negro mate
9,7 x 30	R90AKFMPR30-	75	80	85
9,7 x 45	R90AKFMPR45-	95	100	105

LIMPIACRISTALES metálico con mango en goma

Código	Precio / Preço
R90RACLA0B	61



X 30 cm
Y 1,2 cm
Z 9,7 cm

◀ **REPISA CON VASO Y DOSIFICADOR DE JABÓN + PORTA DOSIFICADOR PARA CRISTAL**



Medidas (cm)	Código	Selección de acabados/Precio		
		U	B	H
		Blanco mate Branco mate	Silver Abrillatado	Negro mate
9,7 x 30	R90AKFMPB30-	133	138	144
9,7 x 45	R90AKFMPB45-	170	175	180



X 35/50/65 cm
Y 8,5 cm
Z 10,9 cm

◀ **REPISA CONTENEDOR CON FRONTAL**



Medidas (cm)	Código	Selección de color / precio		
		U	B	H
		Blanco mate Branco mate	Silver Abrillatado	Negro mate
10,9 x 35	R90AKFMMA135-	132 €	137 €	142 €
10,9 x 50	R90AKFMMA150-	142 €	147 €	153 €
10,9 x 65	R90AKFMMA165-	153 €	158 €	163 €



REPISA PORTAOBJETOS CON TOALLERO VOLADIZO



Medidas (cm)	Código	Selección de color / precio		
		U	B	H
		Blanco mate Branco mate	Silver Abrillantado	Negro mate
10,9 x 80	R90AKFMMA380-	147	153	158
10,9 x 120	R90AKFMMA3120-	163	168	174
10,9 x 140	R90AKFMMA3140-	179	184	189



REPISA CON FRONTAL VOLADIZO A DERECHA CON TOALLERO + VASO Y DOSIFICADOR DE JABÓN



Medidas (cm)	Código	Derecha	Izquierda	Selección de color / precio		
		Direita	Esquerda	U	B	H
				Blanco mate Branco mate	Silver Abrillantado	Negro mate
10,9 x 100	R90AKFMMA2100F	D-	S-	279 €	284 €	289 €
10,9 x 110	R90AKFMMA2110F	D-	S-	289 €	294 €	300 €

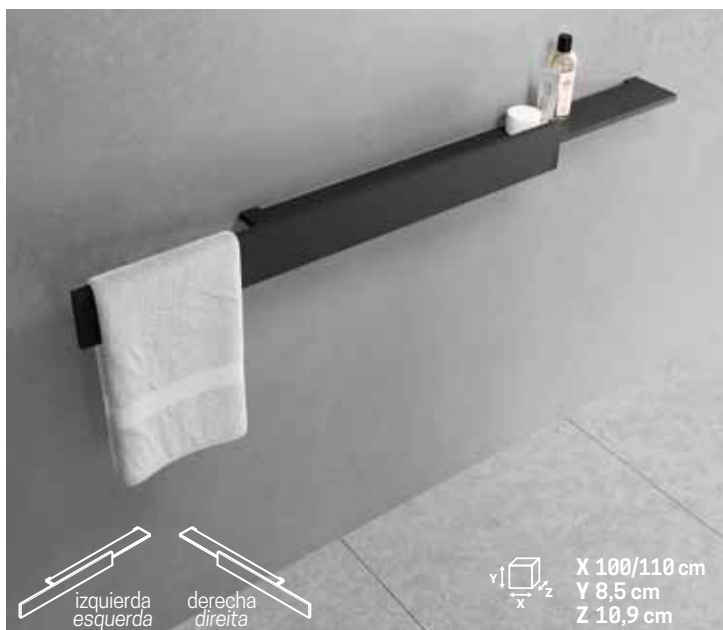

REPISA CON FRONTAL VOLADIZO CON TOALLERO + VASO Y DOSIFICADOR DE JABÓN



Medidas (cm)	Código	Derecha	Izquierda	Selección de color / precio		
		Direita	Esquerda	U	B	H
				Blanco mate Branco mate	Silver Abrillantado	Negro mate
10,9 x 100	R90AKFMMA2100	D-	S-	147	153	158
10,9 x 110	R90AKFMMA2110	D-	S-	158	163	168



◀ **REPISA CON ESPACIO PARA ESPEJO
(con grosor máx. de 35 mm)**

(espejo no incluido)



Blanco Silver Negro
Branco Abrilantado Negro mate

Medidas (cm)	Código	Selección de color / precio		
		U	B	H
		Blanco mate Branco mate	Silver Abrilantado	Negro mate
12,5 x 85	R90AKFMS85-	147 €	153 €	158 €
12,5 x 110	R90AKFMS110-	147 €	153 €	158 €

X 85/110 cm
Y 1,2 cm
Z 12,5 cm

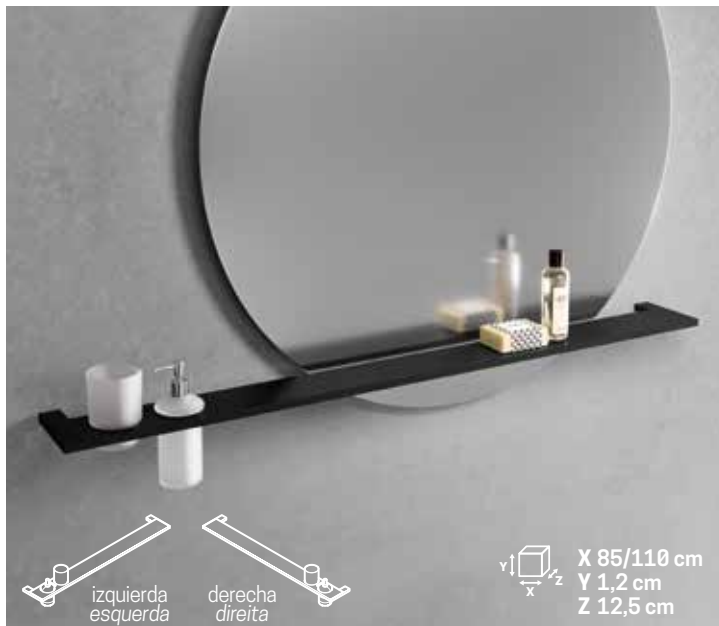

◀ **REPISA CON ESPACIO PARA ESPEJO
DERECHA CON VASO Y DOSIFICADOR DE JABÓN
(con grosor máx. de 35 mm)**

(espejo no incluido)



Blanco Silver Negro
Branco Abrilantado Negro mate

Medidas (cm)	Código	Derecha	Izquierda	Selección de color / precio		
		Direita	Esquerda	U	B	H
		D-	S-	Blanco mate Branco mate	Silver Abrilantado	Negro mate
12,5 x 85	R90AKFMSF85	D-	S-	279	284	289
12,5 x 110	R90AKFMSF110	D-	S-	279	284	289

X 85/110 cm
Y 1,2 cm
Z 12,5 cm

izquierda
esquerda

derecha
direita



◀ **PARRILLA PARA TOALLAS**



Blanco Silver Negro
Branco Abrilantado Negro mate

Medidas (cm)	Código	Selección de acabados/Precio		
		U	B	H
		Blanco mate Branco mate	Silver Abrilantado	Negro mate
35 x 61,2	R90AKFPA-	276 €	297 €	318 €

X 61,2 cm
Y 6 cm
Z 35 cm



X 30/45/60 cm
 Y 6 cm
 Z 9 cm

TOALLERO / TOALHEIRO



Medidas (cm)	Código	Selección de acabados/Precio		
		U	B	H
		Blanco mate Branco mate	Silver Abrillantado	Negro mate
9 x 30	R90AKFPS0130-	101 €	106 €	112 €
9 x 45	R90AKFPS0145-	106 €	112 €	117 €
9 x 60	R90AKFPS0160-	122 €	128 €	133 €



X 30/45/60 cm
 Y 6 cm
 Z 10 cm

TOALLERO DOBLE



Medidas (cm)	Código	Selección de acabados/Precio		
		U	B	H
		Blanco mate Branco mate	Silver Abrillantado	Negro mate
10 x 30	R90AKFPS0230-	117 €	122 €	133 €
10 x 45	R90AKFPS0245-	122 €	133 €	144 €
10 x 60	R90AKFPS0260-	128 €	138 €	149 €



X 30/45/60 cm
 Y 6 cm
 Z 12 cm

TOALLERO CON ESPACIO CONTENEDOR



Medidas (cm)	Código	Selección de acabados/Precio		
		U	B	H
		Blanco mate Branco mate	Silver Abrillantado	Negro mate
12 x 30	R90AKFMPS30-	122 €	128 €	133 €
12 x 45	R90AKFMPS45-	133 €	138 €	144 €
12 x 60	R90AKFMPS60-	144 €	149 €	154 €



X 40 cm
Y 4,2 cm
Z 6 cm

TOALLERO PARA LATERAL DE MUEBLE



Bianco opaco

Silver

Nero opaco

Medidas (cm)	Código	Selección de color / precio		
		U	B	H
		Blanco mate Branco mate	Silver Abrillantado	Negro mate
6 x 40	R90AKFMPS140-	84 €	90 €	95 €



X 6 cm
Y 4 cm
Z 3,3 cm

PERCHA DE PARED



Bianco
Branco

Silver
Abrillantado

Negro
mate

Medidas (cm)	Código	Selección de acabados/Precio		
		U	B	H
		Blanco mate Branco mate	Silver Abrillantado	Negro mate
6 x 4	R90AKFPAQM-	43 €	48 €	53 €

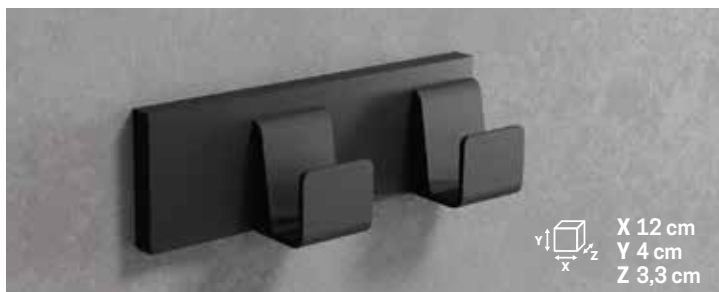

X 12 cm
Y 4 cm
Z 3,3 cm

PERCHA DOBLE

12 x 4	R90AKFPAQM2-	85 €	96 €	106 €
--------	---------------------	------	------	-------



X 21,2 cm
Y 16,1 cm
Z 9,7 cm



X 21,2 cm
Y 31,1 cm
Z 9,7 cm

PORTARROLLOS SIMPLE Y DOBLE



Bianco
Branco

Silver
Abrillantado

Negro
mate

Medidas (cm)	Código	Selección de acabados/Precio		
		U	B	H
		Blanco mate Branco mate	Silver Abrillantado	Negro mate

PORTARROLLOS INDIVIDUAL

16,2 x 21,2	R90AKFPR16-	101 €	106 €	112 €
-------------	--------------------	-------	-------	-------

PORTARROLLOS DOBLE

31,2 x 21,2	R90AKFPR31-	133 €	144 €	154 €
-------------	--------------------	-------	-------	-------



PORTARROLLOS INDIVIDUAL + ESCOBILLERO



Medidas (cm)	Código	Selección de acabados/Precio		
		U	B	H
21,2 x 75	R90AKFPRS-	Blanco mate Branco mate	Silver Abrillantado	Negro mate
		223 €	239 €	255 €

X 21,2 cm
Y 75 cm
Z 9,7 cm



COLUMNA TOALLERO, PORTARROLLOS Y ESCOBILLERO



Medidas (cm)	Código	Selección de acabados/Precio		
		U	B	H
47 x 75	R90AKFPRS-	Blanco mate Branco mate	Silver Abrillantado	Negro mate
		297	318	340

X 47 cm
Y 75 cm
Z 15 cm



COLUMNA TOALLERO

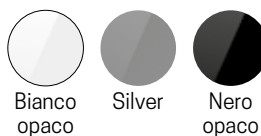

Medidas (cm)	Código	Selección de color / precio		
		U	B	H
35 x 75	R90AKFPS-	Blanco mate Branco mate	Silver Abrillantado	Negro mate
		200 €	216 €	231 €

X 35 cm
Y 75 cm
Z 15 cm



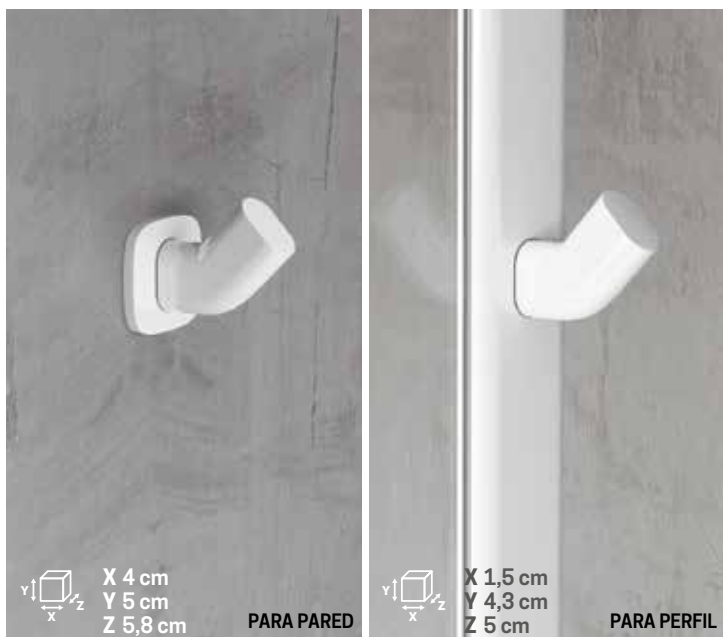

PERCHA



Blanco Silver Negro
Branco Abrrilantado mate

Código	Selección de acabados/Precio		
	A	B	H
	Blanco Branco	Silver Abrrilantado	Negro mate

PARA PARED

R90AGEPAM-	32 €	38 €	43 €
-------------------	------	------	------

PARA PERFIL

R90AGEPAP-	27 €	32 €	38 €
-------------------	------	------	------

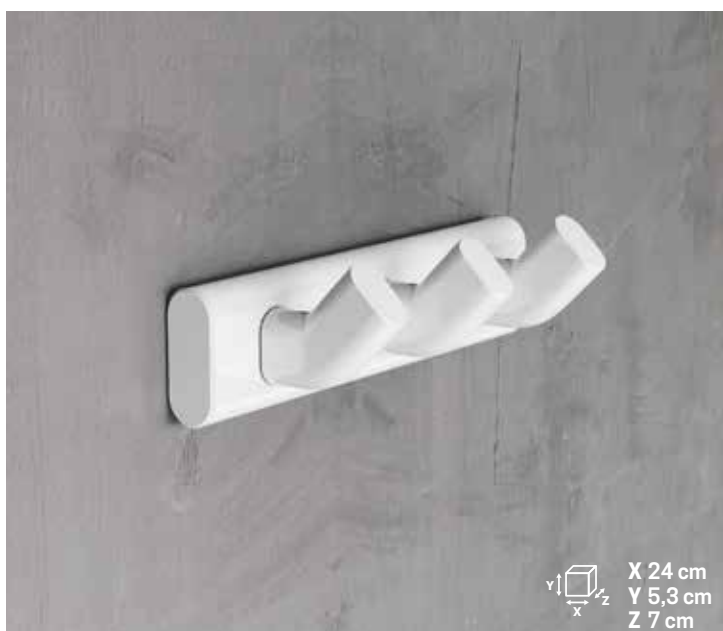

PERCHA MÚLTIPLE



Blanco Silver Negro
Branco Abrrilantado mate

Código	Selección de acabados/Precio		
	A	B	H
	Blanco Branco	Silver Abrrilantado	Negro mate
R90AGEPAM3-	106 €	117 €	128 €

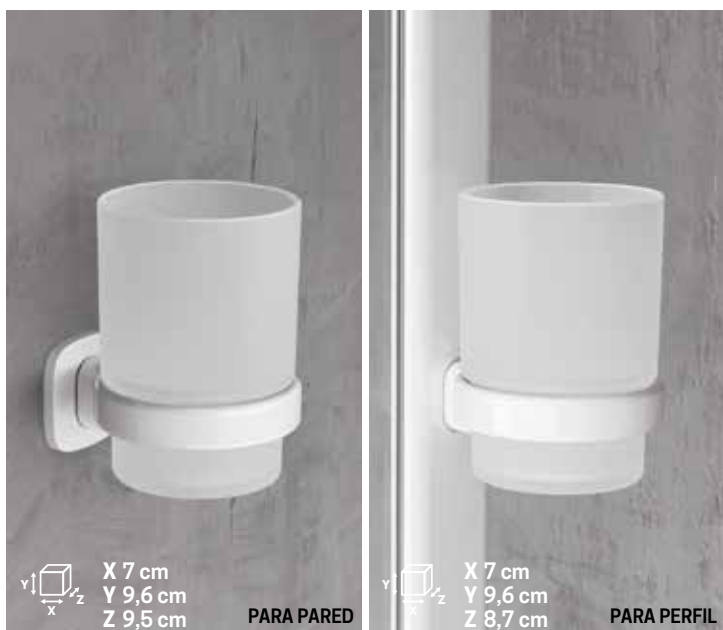

VASO



Blanco Silver Negro
Branco Abrrilantado mate

Código	Selección de acabados/Precio		
	A	B	H
	Blanco Branco	Silver Abrrilantado	Negro mate

PARA PARED

R90AGEBIM-	59 €	64 €	69 €
-------------------	------	------	------

PARA PERFIL

R90AGEBIP-	53 €	59 €	64 €
-------------------	------	------	------



DOSIFICADOR



Código	Selección de acabados/Precio		
	A	B	H
	Blanco Branco	Silver Abrelantado	Negro mate

PARA PARED

R90AGEDSM-	69 €	75 €	80 €
-------------------	------	------	------

PARA PERFIL

R90AGEDSP-	64 €	69 €	75 €
-------------------	------	------	------



SOPORTE PARA SECADOR



Código	Selección de acabados/Precio		
	A	B	H
	Blanco Branco	Silver Abrelantado	Negro mate

R90AGEPPM-	38 €	43 €	48 €
-------------------	------	------	------



SOPORTE PARA LIMPIACRISTALES
(limpiacristales no incluido)



Código	Selección de acabados/Precio		
	A	B	H
	Blanco Branco	Silver Abrelantado	Negro mate

PARA PARED

R90AGEPRM-	32 €	38 €	43 €
-------------------	------	------	------

PARA PERFIL

R90AGEPRP-	27 €	32 €	38 €
-------------------	------	------	------



PARA PARED



PARA PERFIL

REPISA



Código	Selección de acabados/Precio		
	A	B	H
	Blanco Branco	Silver Abrrillatado	Negro mate
PARA PARED			
R90AGEMEM-	53 €	59 €	64 €
PARA PERFIL			
R90AGEMEP-	48 €	53 €	59 €

PORTARROLLOS



Código	Selección de acabados/Precio		
	A	B	H
	Blanco Branco	Silver Abrrillatado	Negro mate
R90AGEPT-	91 €	96 €	101 €



ESCOBILLERO



Código	Selección de acabados/Precio		
	A	B	H
	Blanco Branco	Silver Abrrillatado	Negro mate
R90AGEPS-	75 €	85 €	96 €





X 8,5 cm
Y 65 cm
Z 12,2 cm

PORTARROLLOS + ESCOBILLERO



Blanco Silver Negro
Branco Abrilantado mate

Código	Selección de acabados/Precio		
	A	B	H
	Blanco Branco	Silver Abrilantado	Negro mate
R90AGEPTS-	170 €	186 €	202 €



X 90 cm
Y 4,5 cm
Z 10 cm

TOALLERO Y REPISA RETROILUMINADA

para combinar con bañeras DIVINA, CALOS 2.0 y SENSE 3-4 con paneles acabado madera



Blanco Silver Negro
Branco Abrilantado mate

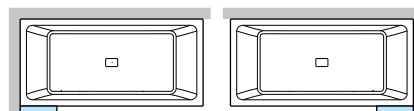

S Izquierda
Esquerda

D Derecha
Direita

Medidas (cm)	Código	Derecha	Izquierda	Selección de acabados/Precio		
		Direita	Esquerda	A	B	H
		D-	S-	Blanco Branco	Silver Abrilantado	Negro mate
70	R90AGEBPSML	D-	S-	350 €	371 €	393 €



X 146/166/176 cm
Y 4,5 cm
Z 9 cm

REPISA RETROILUMINADA

para combinar con bañeras DIVINA, CALOS 2.0 y SENSE 3-4 con paneles acabado madera



Blanco Silver Negro
Branco Abrilantado mate

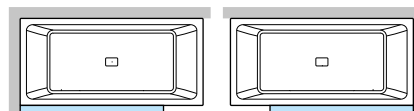

S Izquierda
Esquerda

D Derecha
Direita

Medida bañera	Código	Derecha	Izquierda	Selección de acabados/Precio		
		Direita	Esquerda	A	B	H
		D-	S-	Blanco Branco	Silver Abrilantado	Negro mate
150-160	R90AGEBPSM150	D-	S-	292 €	313 €	334 €
170	R90AGEBPSM170	D-	S-	303 €	324 €	345 €
180-190	R90AGEBPSM180	D-	S-	313 €	334 €	356 €



X 30/45/65 cm
Y 4,5 cm
Z 10 cm

TOALLERO



Blanco Silver Negro
Branco Abrrilantado mate

Medidas (cm)	Código	Selección de acabados/Precio		
		A	B	H
		Blanco Branco	Silver Abrrilantado	Negro mate
30	R90AGEBPS30-	96 €	101 €	106 €
45	R90AGEBPS45-	106 €	112 €	117 €
65	R90AGEBPS65-	112 €	117 €	128 €



ACCESORIO LIMPIACRISTALES ACESSORIOS LIMPA VIDRO

Accesorio limpiacristales en metal cromado (Colgador no incluido)
Acessorios limpa vidros em metal cromado
(Cabide nao incluido)

Código	Precio / Preço
R90RACLA0B	78 €

Accesorio
limpiacristales en latón cromado
Acessorios limpa vidros em
metal cromado



Revestimiento
especial
antideslizante
Revestimiento
antiderrapante



ACCESORIO LIMPIACRISTALES ACESSORIOS LIMPA VIDROS

Accesorio limpiacristales en metal cromado (Colgador no incluido)
Acessorios limpa vidros em metal cromado
(Cabide nao incluido)

Código	Precio / Preço
R90RACLA0A	41 €

Accesorio
limpiacristales en latón cromado
Acessorios limpa vidros em
metal cromado

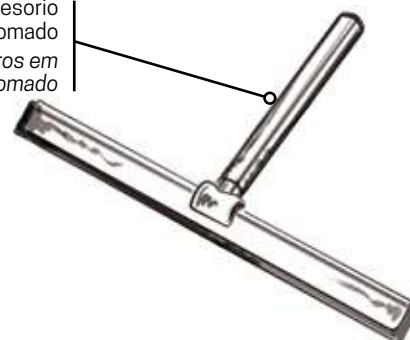



X 32 cm
Y 44 cm
Z 26 cm

ASIENTO EN MATERIAL ACRÍLICO OPACO DE ALTA RESISTENCIA
ASSENTO EM MATERIAL ACRILICO OPACO DE ALTA RESISTENCIA
(Peso máximo 100 kgs)

Código	Precio / Preço
SED030PL	391 €

Asiento ergonómico, elegante y comfortable, de superficie antideslizante
Assento ergonómico, elegante e confortável, de superfície antideslizante

Asiento en material acrílico opaco de alta resistencia
Assento em material acrílico opaco de alta resistencia

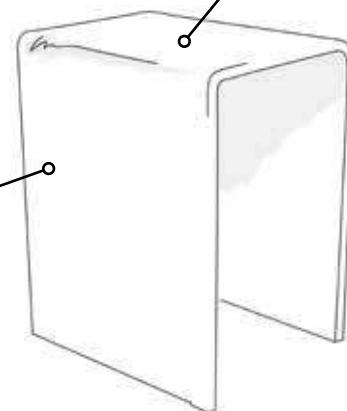

X 37 cm
Y 37 cm
Z 48 cm

TABURETE BANCO
(Peso máximo 150 kgs)

Taburete negro RAL 7021 o blanco RAL 9003, con soporte de aluminio anodizado
Banco negro ral 7021 ou branco ral 9003, com estrutura aluminio anodizado

Color/Cores	Código	Precio / Preço
Blanco / Branco	SED02Q-A	599 €
Negro	SED02Q-H	599 €

Asiento ergonómico, elegante y comfortable, de superficie antideslizante
Assento ergonómico, elegante e confortável, de superfície antideslizante

Pies de metal anodizado silver
Pes de metal anodizado silver

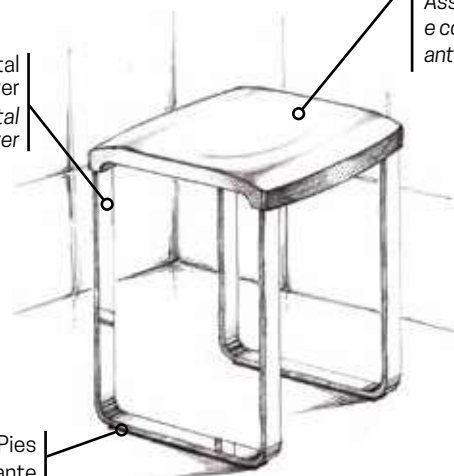

Pies antideslizante

SGS Probad por SGS según EN12520:2010

Sólida estructura de acero inoxidable con mecanismo de rotación.
Sólida estrutura de aço inoxidável com mecanismo de rotação

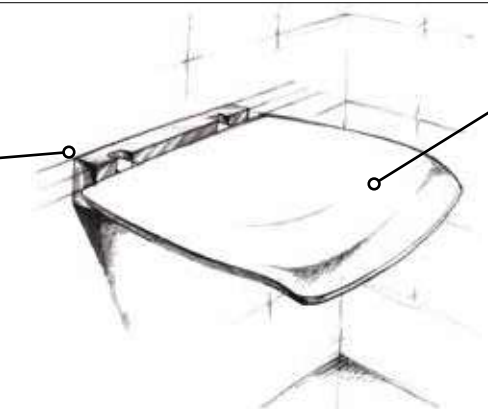

Asiento ergonómico y comfortable, de superficie antideslizante
Assento ergonómico e confortável, de superfície antideslizante

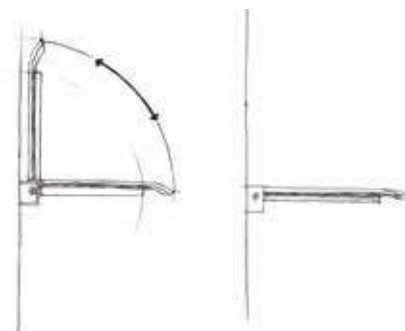

X 38 cm
Y 7 cm
Z 37 cm



X 33 cm
Y 20 cm
Z 27 cm

**ASIENTO PLEGABLE
ASSENTO REBATIVEL
(Peso máximo 100 kgs)**

Taburete negro RAL 7021 o blanco RAL 9033, con estructura aluminio anodizado
Banco negro RAL 7021 ou branco RAL 9033, com estrutura aluminio anodizado

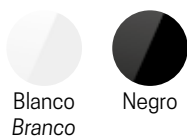

Color/Cores	Código	Precio / Preço
Blanco / Branco	SED02QFM-A	395 €
Negro	SED02QFM-H	395 €

**ASIENTO REDONDEADO PLEGABLE EN EVA
ASSENTO REDONDO REBATIVEL EM EVA
(Peso máximo 100 kgs)**

Taburete negro RAL 7021 o blanco RAL 9033, con estructura aluminio anodizado
Banco negro RAL 7021 ou branco RAL 9033, com estrutura aluminio anodizado

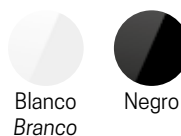

Color/Cores	Código	Precio / Preço
Blanco / Branco	SED01FM-A	437 €
Negro	SED01FM-H	481 €



CESTA PORTAOBJETOS DESMONTABLE PORTA OBJETOS DESMONTAVEL

Cesta extraíble de metal cromado
Cesta extraível em metal cromado

Código	Precio / Preço
R90CESTE0F	121 €



CESTA PORTAOBJETOS ANGULAR DESMONTABLE PORTA OBJETOS DE CANTO DESMONTAVEL

Cesta porta objetos en metal cromado
Porta objetos em metal cromado

Código	Precio / Preço
R90CESTE0G	121 €



CESTA PORTAOBJETOS PARA CRISTAL DE DUCHA PORTA OBJETOS COM CABIDE PARA VIDRO DE DUCHE

Cesta portaobjetos con percha en metal cromado
Porta objetos em metal cromado

Código	Precio / Preço
R90CESTE0H	268 €



X 22 cm
Y 7 cm
Z 11 cm

CESTA PORTAOBJETOS de dos piezas extraíbles
PORTA OBJETOS de duas peças extraíveis

Cesta contenedor portaobjetos con estructura metálica cromada y cesta interior extraíble para facilitar la limpieza en ABS blanco RAL 9003 o negro RAL 7021

Porta objetos estrutura metalica com cesta extraivel para facilitar a limpeza

Color de la cesta interior extraíble:

Inserção de plástico de cor:

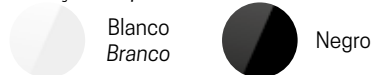

Color/Cores	Código	Precio / Preço
Blanco/Branco	R90CESTE0A-A	127 €
Negro	R90CESTE0A-H	127 €



X 17 cm
Y 7 cm
Z 16 cm

CESTA ANGULAR de dos piezas extraíbles
PORTA OBJETOS ANGULAR com duas peças extraíveis

Cesta contenedor portaobjetos con estructura metálica cromada y cesta interior extraíble para facilitar la limpieza en ABS blanco RAL 9003 o negro RAL 7021

Porta objetos estrutura metalica com cesta extraivel para facilitar a limpeza

Color de la cesta interior extraíble:

Inserção de plástico de cor:

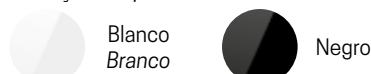

Color/Cores	Código	Precio / Preço
Blanco/Branco	R90CESTE0B-A	127 €
Negro	R90CESTE0B-H	127 €



X 17 cm
Y 38 cm
Z 16 cm

CESTA PORTAOBJETOS ANGULAR de dos piezas extraíbles
PORTA OBJETOS ANGULAR duplo com duas peças extraíveis

Cesta contenedor portaobjetos con estructura metálica cromada y cesta interior extraíble para facilitar la limpieza en ABS blanco RAL 9003 o negro RAL 7021

Porta objetos estrutura metalica com cesta extraivel para facilitar a limpeza

Color de la cesta interior extraíble:

Inserção de plástico de cor:

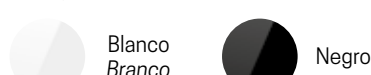

Color/Cores	Código	Precio / Preço
Blanco/Branco	R90CESTE0D-A	268 €
Negro	R90CESTE0D-H	268 €

ACCESORIOS / ACESSÓRIOS



CESTA DOBLE de dos piezas extraíbles con percha para colgar sobre cristal de ducha PORTA OBJETOS duplo extraíveis com cabine para pendurar no vidro do duche

Cesta contenedor portaobjetos con estructura metálica cromada y cesta interior extraíble para facilitar la limpieza en ABS blanco RAL 9003 o negro RAL 7021

Porta objetos estrutura metalica com cesta extraivel para facilitar la limpeza

Color de la cesta interior extraíble:

Inserção de plástico de cor:



Blanco
Branco



Negro

Color/Cores	Código	Precio / Preço
Blanco/Branco	R90CESTE0E-A	312 €
Negro	R90CESTE0E-H	312 €



BARRA AGARRADERA DE SEGURIDAD PEGA DE SEGURANÇA

Barra de metal lacado o cromado

Pega em metal cromado ou lacado

Color/Cores	Código	Precio / Preço
Blanco / Branco	R90MANGL0C-A	172 €
Negro mate	R90MANGL0C-H	216 €
Cromo	R90MANGL0C-K	262 €

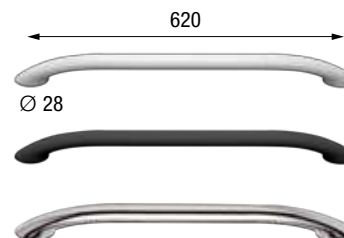



**COLGADOR DOBLE
CABIDE DUPLO**

Colgador cromado para cristal hasta 10 mm de espesor
Cabide para vidros até 10 mm

Código	Precio / Preço
R90APPEN0G	21 €

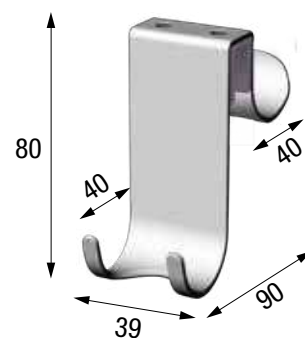

**COLGADOR
CABIDE**

Colgador cromado para cristal hasta 10 mm de espesor
Cabide para vidros até 10 mm

Código	Precio / Preço
R90APPEN0D	21 €

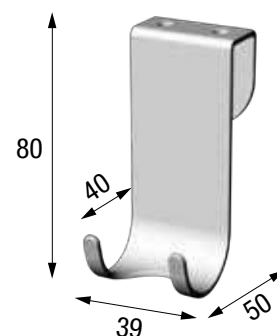

**COLGADOR
CABIDE**

Colgador cromado para pared
Cabide para parede

Código	Precio / Preço
R90APPEN0E	18 €

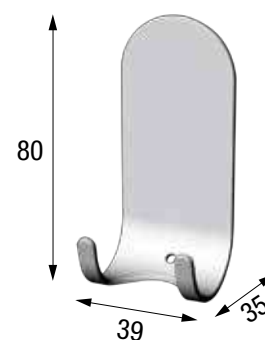

**COLGADOR
CABIDE**

Colgador en metal cromado
Cable em metal cromado

Código	Precio / Preço
R90APPEN0F	21 €

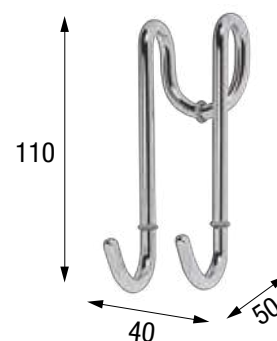

BARRA DE SUJECIÓN 150 cm BARRA DE FIXAÇÃO 150 cm (tipo Kuadra H)



Color Cores	Código	Precio Preço
Blanco Branco	R80GIANF15-A	99 €
Blanco mate Branco mate	R80GIANF15-U	99 €
Silver Brillantado	R80GIANF15-B	110 €
Cromo	R80GIANF15-K	122 €
Negro mate	R80GIANF15-H	122 €
Inox satinado	R80GIANF15-Z	146 €

BARRA DE SUJECIÓN 150 cm BARRA DE FIXAÇÃO 150 cm (tipo Lunes H)



Color Cores	Código	Precio Preço
Blanco Branco	R80LUH15-A	64 €
Silver Brillantado	R80LUH15-B	69 €
Cromo	R80LUH15-K	76 €

BARRA ESTABILIZADORA ANGULAR BARRA DE REFORÇO ANGULAR Colores perfiles cromo



Color Cores	Medidas	Código	Precio Preço
Blanco mate Branco mate	25 cm	R80LOU250-U	76 €
Cromo		R80LOU250-K	76 €
Negro mate		R80LOU250-H	76 €
Inox satinado		R80LOU250-Z	92 €
Blanco mate Branco mate	35 cm	R80LOU350-U	83 €
Cromo		R80LOU350-K	83 €
Negro mate		R80LOU350-H	83 €
Inox satinado		R80LOU350-Z	100 €
Blanco mate Branco mate	45 cm	R80LOU450-U	90 €
Cromo		R80LOU450-K	90 €
Negro mate		R80LOU450-H	90 €
Inox satinado		R80LOU450-Z	108 €

BARRA DE SUJECIÓN / BARRA DE FIXAÇÃO (para Aurora/ Star)



Color Cores	Código	Precio Preço
Blanco Branco	R80FIS46-A	53 €
Silver Brillantado	R80FIS46-B	63 €

KIT PARA FIJACIÓN A TECHO DE LA BARRA DE SUJECIÓN SUMINISTRADA KIT PARA FIXAÇÃO AO TECTO DA BARRA DE FIXAÇÃO (FORNECIDA)



Color Cores	Código	Precio Preço
Blanco Branco	R801SOFEL-A	42 €
Cromo	R801SOFEL-K	46 €
Negro mate	R801SOFEL-H	46 €

SÓLO COMPATIBLE CON BARRA R80GIANF15

PERFIL DE FIJACIÓN A TECHO 6/8 mm - H 297 cm PEÇA DE FIXAÇÃO DO VIDRO AO CHÃO 6/8 mm - H 297 cm



Color Cores	Código	Precio Preço
Blanco Branco	R80GKHSOF-D	201 €
Blanco mate Branco mate	R80GKHSOF-U	201 €
Silver Brillantado	R80GKHSOF-B	222 €
Cromo	R80GKHSOF-K	244 €
Negro mate	R80GKHSOF-H	244 €
Inox satinado	R80GKHSOF-Z	293 €

PIEZA DE SUJECIÓN DEL CRISTAL A SUELO
PEÇA DE FIXAÇÃO DO VIDRO AO CHÃO

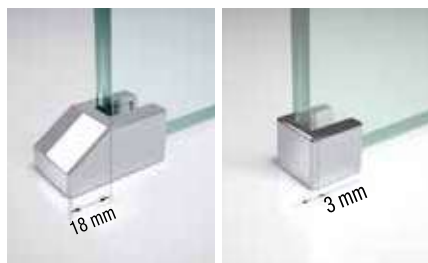

Color Cores	Código	Precio Preço
PARA KUADRA H (8 MM)		
Blanco / Branco	R05PIKUH1-A	16 €
Cromo	R05PIKUH1-K	19 €
Negro mate	R05PIKUH1-H	19 €
Inox satinado	R05PIKUH1-Z	23 €
PARA GIADA H (6 MM)		
Blanco / Branco	R05PIGIH1-A	16 €
Cromo	R05PIGIH1-K	19 €

PERFIL ESTANCO DE ALUMINIO
para fijos de 6/8 mm
PERFIS ESTANCO DE ALUMÍNIO
para fixos de 6/8 mm



Color Cores	Medidas	Código	Precio Preço
Blanco Branco	100	P51BOHU10-A	30 €
Blanco mate Branco mate		P51BOHU10-U	30 €
Silver Abrillantado		P51BOHU10-B	35 €
Cromo		P51BOHU10-K	39 €
Negro mate		P51BOHU10-H	39 €
Inox satinado		P51BOHU10-Z	48 €

PIEZA PARA ELEVACIÓN DEL FIJO
SOBRE EL PLATO DE DUCHA Ø 29 MM
PEÇA PARA ELEVACÃO DO FIXO SOBRE A
BASE DE CHUVEIRO Ø 29 MM

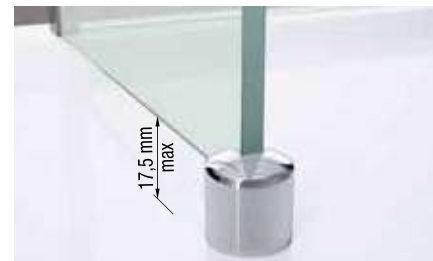

Código	Precio / Preço
R05KUHL1-K	64 €

KIT BARRA ORIENTABLE



Color Cores	Medidas	Código	Precio Preço
Blanco mate	100	R80KUOR100-U	111 €
Silver / Abr.		R80KUOR100-B	124 €
Cromo		R80KUOR100-K	135 €
Negro mate		R80KUOR100-H	135 €
Inox satinado		R80KUOR100-Z	162 €
Blanco mate	150	R80KUOR150-U	115 €
Silver / Abr.		R80KUOR150-B	127 €
Cromo		R80KUOR150-K	140 €
Negro mate		R80KUOR150-H	140 €
Inox satinado		R80KUOR150-Z	168 €
Blanco mate	180	R80KUOR180-U	121 €
Silver / Abr.		R80KUOR180-B	131 €
Cromo		R80KUOR180-K	143 €
Negro mate		R80KUOR180-H	143 €
Inox satinado		R80KUOR180-Z	172 €

1 barra orientable de 100/150/180 cm (ajustable)
1 pieza de sujeción a pared / peça fixação a parede
1 Pieza de fijación al cristal / peça fixação a vidro

FILTRO DE AGUA PARA CABINAS DE HIDROMASAJE

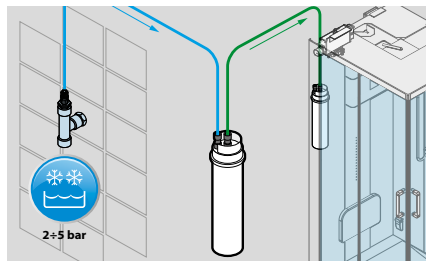

Código	Precio / Preço
R90FLTATC01	216 €

Distancia entre ejes 256 mm
KUADRA



Color Cores	Código	Precio / Preço
Cromo	R40MAGIN1-K	69 €

Distancia entre ejes 256 mm
ROSE



Color Cores	Código	Precio / Preço
Cromo	R40MAROS1-K	69 €

Distancia entre ejes 256 mm
ROSE



Color Cores	Código	Precio / Preço
Cromo	R40MACNF1-K	76 €

Distancia entre ejes 256 mm
ROSE



Color Cores	Código	Precio / Preço
Cromo	R40MANEX1-K	105 €

Distancia entre ejes 256 mm
ROSE



Color Cores	Código	Precio / Preço
Cristallo	R40MAROS2-K	69 €

Distancia entre ejes 160 mm
ZEPHYROS 2.0



Color Cores	Código	Precio / Preço
Cromo	R40MATWS1-K	58 €
Negro mate	R40MATWS1-H	58 €

Distancia entre ejes 140 mm



Color Cores	Código	Precio / Preço
Cromo	R40MAYOU2-K	58 €

Distancia entre ejes 384 mm
YOUNG - YOUNG PLUS - EON



Color Cores	Código	Precio / Preço
Cromo	R40EIMAGIN1-K	120 €

Distancia entre ejes 256 mm
ROSE - SKILL



Color Cores	Código	Precio / Preço
Cromo	R40EIMACNF1-K	126 €

Distancia entre ejes 256 mm
ROSE - SKILL



Color Cores	Código	Precio / Preço
Cromo	R40EIMAZPH2-K	100 €
Negro	R40EIMAZPH2-H	100 €

Distancia entre ejes 140 mm
ZEPHYROS



Color Cores	Código	Precio / Preço
Cromo	R40EIMAY21-K	93 €
Negro	R40EIMAY21-H	93 €

Distancia entre ejes 140 mm



Color Cores	Código	Precio / Preço
Blanco/Branco	R40MAEV1-A	20 €
Cromo	R40MAEV1-K	25 €

**PERFIL EMBELLECEDOR
PERFIL EMBELEZADOR**



Código	Precio / Preço
PRVA2-A	98 €

**KIT 2 EMBELLECEDORES DE
PLÁSTICO RÍGIDO 195 cm
KIT 2 EMBELEZADORES DE
PLASTICO RIGIDO 195 cm**

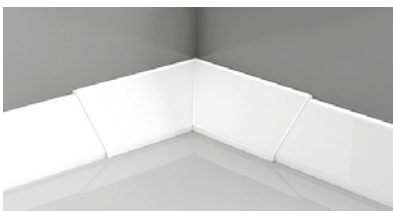

Código	Precio / Preço
PRVA195-30	78 €

**PERFIL EMBELLECEDOR RÍGIDO
DE ALUMINIO
PERFIL EMBELEZADOR RIGIDO**



Medidas	Código	Precio Preço
1 lado 185 cm	PRV185-30	89 €
2 lados / painéis 185x85	PRV18585-30	114 €
3 lados / painéis 85x185x85 cm	PRV8518585-30	136 €

**PANEL DE INSPECCIÓN
PAINEL DE INSPECÇÃO**



SENSE

Código	Precio / Preço
PANISPEL-A	177 €

IRIS, CALOS 2.0, UNA, VOGUE,
VENUS, CALYPSO, BABY

Código	Precio / Preço
PANISP-A	177 €

COLUMNA DE DESAGÜE



Código	Precio / Preço
COLSCAVK-K	105 €

TUBO DE DESAGÜE ANTI-GOTA



Código	Precio / Preço
R90SCDOCBV	147 €

**KIT PIES REGULABLES
PÉS DE REGULAÇÃO**



Código	Precio / Preço
PIEDVASCA	68 €

**KIT PIES REGULABLES PARA
BAÑERA EMPOTRAR
PÉS DE REGULAÇÃO PARA
BANHEIRA EMBUTIR**



Código	Precio / Preço
PIEDVASCA70	74 €
PIEDVASCA75	74 €
PIEDVASCA80	74 €
PIEDVASCA90	74 €
PIEDVASCA100	74 €

**KIT DE LIMPIEZA con pulverizador
KIT DE LIMPEZA com pulverizador**



Código	Precio / Preço
KITPUPV12	205 €

PERFILES / PERFÍS PARA MAMPARAS / PARA RESGUARDOS

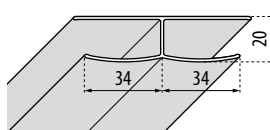

LUNES / STAR 2.0 H 195 cm
ZEPHYROS 2.0 H 200 cm
STAR H 185 cm

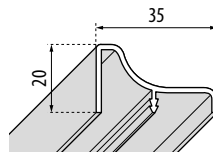

LUNES / STAR 2.0 H 195 cm
ZEPHYROS 2.0 H 200 cm
STAR H 185 cm

Color Cores	Código			medida altura (max 200 cm)		
	LUNES	ZEPHYROS 2.0	STAR	Standard	Especial	
	STAR 2.0				<190	>190
Blanco Branco	PROH15ST3-A	PROH15ST2-U	PROH15ST1-A	61 €		
	PROH1501	PROH1501	PROH1501		66 €	
	PROH1502	PROH1502	PROH1502			70 €
Silver Brillantado	PROH15ST3-B	PROH15ST2-B	PROH15ST1-B	69 €		
	PROH1501	PROH1501	PROH1501		73 €	
	PROH1502	PROH1502	PROH1502			78 €
Cromo	PROH15ST3-K	PROH15ST2-K		76 €		
	PROH1501	PROH1501			82 €	
	PROH1502	PROH1502				87 €
Negro mate	PROH15ST3-H	PROH15ST2-H		76 €		
	PROH1501	PROH1501			82 €	
	PROH1502	PROH1502				87 €
Plata Prata	PROH15ST3-J			71 €		
	PROH1501				76 €	
	PROH1502					82 €

Color Cores	Código			medida altura (max 200 cm)		
	LUNES	ZEPHYROS 2.0	STAR	Standard	Especial	
	STAR 2.0				<190	>190
Blanco Branco	PRO002ST3-A	PRO002ST2-U	PRO002ST1-A	61 €		
	PRO00201	PRO00201	PRO00201		66 €	
	PRO00202	PRO00202	PRO00202			70 €
Silver Brillantado	PRO002ST3-B	PRO002ST2-B	PRO002ST1-B	69 €		
	PRO00201	PRO00201	PRO00201		73 €	
	PRO00202	PRO00202	PRO00202			78 €
Cromo	PRO002ST3-K	PRO002ST2-K		76 €		
	PRO00201	PRO00201			82 €	
	PRO00202	PRO00202				87 €
Negro mate	PRO002ST3-H	PRO002ST2-H		76 €		
	PRO00201	PRO00201			82 €	
	PRO00202	PRO00202				87 €
Plata Prata	PRO002ST3-J			71 €		
	PRO00201				76 €	
	PRO00202					82 €

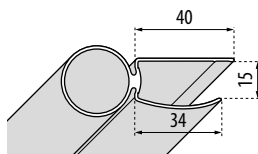

LUNES / STAR 2.0 H 195 cm
ZEPHYROS 2.0 H 200 cm
STAR H 185 cm

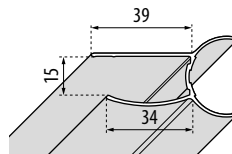

LUNES / STAR 2.0 H 195 cm
ZEPHYROS 2.0 H 200 cm
STAR H 185 cm

Color Cores	Código			medida altura (max 200 cm)		
	LUNES	ZEPHYROS 2.0	STAR	Standard	Especial	
	STAR 2.0				<190	>190
Blanco Branco	INCB001ST3-A	INCB001ST2-U	INCB001ST1-A	65 €		
	INCB00101	INCB00101	INCB00101		69 €	
	INCB00102	INCB00102	INCB00102			73 €
Silver Brillantado	INCB001ST3-B	INCB001ST2-B	INCB001ST1-B	72 €		
	INCB00101	INCB00101	INCB00101		76 €	
	INCB00102	INCB00102	INCB00102			82 €
Cromo	INCB001ST3-K	INCB001ST2-K		80 €		
	INCB00101	INCB00101			85 €	
	INCB00102	INCB00102				91 €
Negro mate	INCB001ST3-H	INCB001ST2-H		80 €		
	INCB00101	INCB00101			85 €	
	INCB00102	INCB00102				91 €
Plata Prata	INCB001ST3-J			74 €		
	INCB00101				80 €	
	INCB00102					85 €

Color Cores	Código			medida altura (max 200 cm)		
	LUNES	ZEPHYROS 2.0	STAR	Standard	Especial	
	STAR 2.0				<190	>190
Blanco Branco	INCA002ST3-A	INCA002ST2-U	INCA002ST1-A	64 €		
	INCA00201	INCA00201	INCA00201		68 €	
	INCA00202	INCA00202	INCA00202			72 €
Silver Brillantado	INCA002ST3-B	INCA002ST2-B	INCA002ST1-B	71 €		
	INCA00201	INCA00201	INCA00201		75 €	
	INCA00202	INCA00202	INCA00202			81 €
Cromo	INCA002ST3-K	INCA002ST2-K		78 €		
	INCA00201	INCA00201			84 €	
	INCA00202	INCA00202				89 €
Negro mate	INCA002ST3-H	INCA002ST2-H		78 €		
	INCA00201	INCA00201			84 €	
	INCA00202	INCA00202				89 €
Plata Prata	INCA002ST3-J			68 €		
	INCA00201				72 €	
	INCA00202					77 €

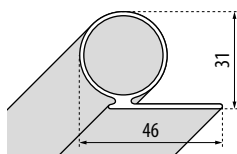

LUNES / STAR 2.0 H 195 cm
ZEPHYROS 2.0 H 200 cm
STAR H 185 cm

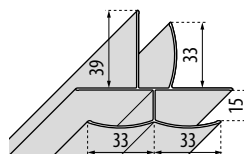

LUNES / STAR 2.0 H 195 cm
ZEPHYROS 2.0 H 200 cm
STAR H 185 cm

Color Cores	Código			medida altura (max 200 cm)		
	LUNES	ZEPHYROS 2.0	STAR	Standard	Especial	
	STAR 2.0				<190	>190
Blanco Branco	INCA005ST3-A	INCA005ST2-U	INCA005ST1-A	64 €		
	INCA00501	INCA00501	INCA00501		68 €	
	INCA00502	INCA00502	INCA00502			72 €
Silver Brillantado	INCA005ST3-B	INCA005ST2-B	INCA005ST1-B	71 €		
	INCA00501	INCA00501	INCA00501		75 €	
	INCA00502	INCA00502	INCA00502			81 €
Cromo	INCA005ST3-K	INCA005ST2-K		78 €		
	INCA00501	INCA00501			84 €	
	INCA00502	INCA00502				89 €
Negro mate	INCA005ST3-H	INCA005ST2-H		78 €		
	INCA00501	INCA00501			84 €	
	INCA00502	INCA00502				89 €
Plata Prata	INCA005ST3-J			68 €		
	INCA00501				72 €	
	INCA00502					77 €

Color Cores	Código			medida altura (max 200 cm)		
	LUNES	ZEPHYROS 2.0	STAR	Standard	Especial	
	STAR 2.0				<190	>190
Blanco Branco	PRT15ST3-A	PRT15ST2-U	PRT15ST1-A	85 €		
	PRT1501	PRT1501	PRT1501		91 €	
	PRT1502	PRT1502	PRT1502			96 €
Silver Brillantado	PRT15ST3-B	PRT15ST2-B	PRT15ST1-B	94 €		
	PRT1501	PRT1501	PRT1501		101 €	
	PRT1502	PRT1502	PRT1502			108 €
Cromo	PRT15ST3-K	PRT15ST2-K		105 €		
	PRT1501	PRT1501			112 €	
	PRT1502	PRT1502				120 €
Negro mate	PRT15ST3-H	PRT15ST2-H		105 €		
	PRT1501	PRT1501			112 €	
	PRT1502	PRT1502				120 €
Plata Prata	PRT15ST3-J			91 €		
	PRT1501				98 €	
	PRT1502					104 €

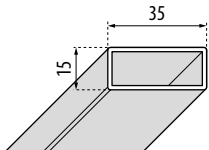

LUNES / STAR 2.0 H 195 cm
ZEPHYROS 2.0 H 200 cm
STAR H 185 cm

Color Cores	Código			medida altura (max 200 cm)		
	LUNES STAR 2.0	ZEPHYROS 2.0	STAR	Standard	Especial	
Blanco Branco	P15X35ST3-A	P15X35ST2-U	P15X35ST1-A	55 €		
	P15X3501	P15X3501	P15X3501		58 €	
	P15X3502	P15X3502	P15X3502			63 €
Silver Brillantado	P15X35ST3-B	P15X35ST2-B	P15X35ST1-B	61 €		
	P15X3501	P15X3501	P15X3501		66 €	
	P15X3502	P15X3502	P15X3502			70 €
Cromo	P15X35ST3-K	P15X35ST2-K		68 €		
	P15X3501	P15X3501			72 €	
	P15X3502	P15X3502				77 €
Negro mate	P15X35ST3-H	P15X35ST2-H		68 €		
	P15X3501	P15X3501			72 €	
	P15X3502	P15X3502				77 €
Plata Prata	P15X35ST3-J			58 €		
	P15X3501				63 €	
	P15X3502					67 €

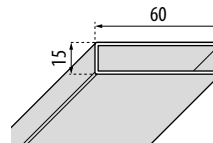

LUNES / STAR 2.0 H 195 cm
ZEPHYROS 2.0 H 200 cm
STAR H 185 cm

Color Cores	Código			medida altura (max 200 cm)		
	LUNES STAR 2.0	ZEPHYROS 2.0	STAR	Standard	Especial	
Blanco Branco	P15X60ST3-A	P15X60ST2-U	P15X60ST1-A	66 €		
	P15X6001	P15X6001	P15X6001		70 €	
	P15X6002	P15X6002	P15X6002			74 €
Silver Brillantado	P15X60ST3-B	P15X60ST2-B	P15X60ST1-B	72 €		
	P15X6001	P15X6001	P15X6001		77 €	
	P15X6002	P15X6002	P15X6002			83 €
Cromo	P15X60ST3-K	P15X60ST2-K		81 €		
	P15X6001	P15X6001			86 €	
	P15X6002	P15X6002				92 €
Negro mate	P15X60ST3-H	P15X60ST2-H		81 €		
	P15X6001	P15X6001			86 €	
	P15X6002	P15X6002				92 €
Plata Prata	P15X60ST3-J			70 €		
	P15X6001				74 €	
	P15X6002					80 €

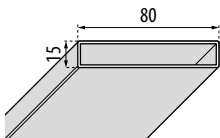

LUNES / STAR 2.0 H 195 cm
ZEPHYROS 2.0 H 200 cm
STAR H 185 cm

Color Cores	Código			medida altura (max 200 cm)		
	LUNES STAR 2.0	ZEPHYROS 2.0	STAR	Standard	Especial	
Blanco Branco	P15X80ST3-A	P15X80ST2-U	P15X80ST1-A	72 €		
	P15X8001	P15X8001	P15X8001		77 €	
	P15X8002	P15X8002	P15X8002			83 €
Silver Brillantado	P15X80ST3-B	P15X80ST2-B	P15X80ST1-B	81 €		
	P15X8001	P15X8001	P15X8001		86 €	
	P15X8002	P15X8002	P15X8002			91 €
Cromo	P15X80ST3-K	P15X80ST2-K		89 €		
	P15X8001	P15X8001			95 €	
	P15X8002	P15X8002				102 €
Negro mate	P15X80ST3-H	P15X80ST2-H		89 €		
	P15X8001	P15X8001			95 €	
	P15X8002	P15X8002				102 €
Plata Prata	P15X80ST3-J			77 €		
	P15X8001				83 €	
	P15X8002					88 €

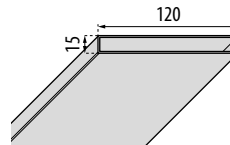

LUNES / STAR 2.0 H 195 cm
ZEPHYROS 2.0 H 200 cm
STAR H 185 cm

Color Cores	Código			medida altura (max 200 cm)		
	LUNES STAR 2.0	ZEPHYROS 2.0	STAR	Standard	Especial	
Blanco Branco	P15X120ST3-A	P15X120ST2-U	P15X120ST1-A	85 €		
	P15X12001	P15X12001	P15X12001		91 €	
	P15X12002	P15X12002	P15X12002			96 €
Silver Brillantado	P15X120ST3-B	P15X120ST2-B	P15X120ST1-B	94 €		
	P15X12001	P15X12001	P15X12001		101 €	
	P15X12002	P15X12002	P15X12002			108 €
Cromo	P15X120ST3-K	P15X120ST2-K		105 €		
	P15X12001	P15X12001			112 €	
	P15X12002	P15X12002				120 €
Negro mate	P15X120ST3-H	P15X120ST2-H		105 €		
	P15X12001	P15X12001			112 €	
	P15X12002	P15X12002				120 €
Plata Prata	P15X120ST3-J			91 €		
	P15X12001				98 €	
	P15X12002					104 €

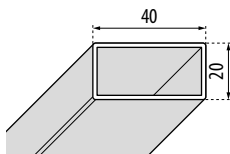

LUNES / STAR 2.0 H 195 cm
ZEPHYROS 2.0 H 200 cm
STAR H 185 cm

Color Cores	Código			medida altura (max 200 cm)		
	LUNES STAR 2.0	ZEPHYROS 2.0	STAR	Standard	Especial	
Blanco Branco	P20X40ST3-A	P20X40ST2-U	P20X40ST1-A	67 €		
	P20X4001	P20X4001	P20X4001		72 €	
	P20X4002	P20X4002	P20X4002			76 €
Silver Brillantado	P20X40ST3-B	P20X40ST2-B	P20X40ST1-B	74 €		
	P20X4001	P20X4001	P20X4001		80 €	
	P20X4002	P20X4002	P20X4002			85 €
Cromo	P20X40ST3-K	P20X40ST2-K		83 €		
	P20X4001	P20X4001			88 €	
	P20X4002	P20X4002				94 €
Negro mate	P20X40ST3-H	P20X40ST2-H		83 €		
	P20X4001	P20X4001			88 €	
	P20X4002	P20X4002				94 €
Plata Prata	P20X40ST3-J			71 €		
	P20X4001				76 €	
	P20X4002					82 €

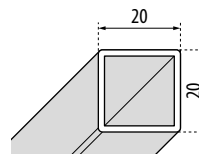

LUNES / STAR 2.0 H 195 cm
ZEPHYROS 2.0 H 200 cm
STAR H 185 cm

Color Cores	Código			medida altura (max 200 cm)		
	LUNES STAR 2.0	ZEPHYROS 2.0	STAR	Standard	Especial	
Blanco Branco	P20X20ST3-A	P20X20ST2-U	P20X20ST1-A	56 €		
	P20X2001	P20X2001	P20X2001		59 €	
	P20X2002	P20X2002	P20X2002			64 €
Silver Brillantado	P20X20ST3-B	P20X20ST2-B	P20X20ST1-B	63 €		
	P20X2001	P20X2001	P20X2001		67 €	
	P20X2002	P20X2002	P20X2002			71 €
Cromo	P20X20ST3-K	P20X20ST2-K		69 €		
	P20X2001	P20X2001			74 €	
	P20X2002	P20X2002				78 €
Negro mate	P20X20ST3-H	P20X20ST2-H		69 €		
	P20X2001	P20X2001			74 €	
	P20X2002	P20X2002				78 €
Plata Prata	P20X20ST3-J			59 €		
	P20X2001				64 €	
	P20X2002					68 €

PERFILES / PERFÍS PARA MAMPARAS / PARA RESGUARDOS

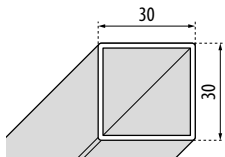

LUNES / STAR 2.0 H 195 cm
ZEPHYROS 2.0 H 200 cm
STAR H 185 cm

Color Cores	Código			medida altura (max 200 cm)		
	LUNES STAR 2.0	ZEPHYROS 2.0	STAR	Standard	Especial	
					<195	>195
Blanco Branco	P30X30ST3-A	P30X30200ST-U	P30X30ST1-A	65 €		
	P30X3001	P30X3001	P30X3001		69 €	
	P30X3002	P30X3002	P30X3002			73 €
Silver Brillantado	P30X30ST3-B	P30X30200ST-B	P30X30ST1-B	72 €		
	P30X3001	P30X3001	P30X3001		76 €	
	P30X3002	P30X3002	P30X3002			82 €
Cromo	P30X30ST3-K	P30X30200ST-K		80 €		
	P30X3001	P30X3001			85 €	
	P30X3002	P30X3002				91 €
Negro mate	P30X30ST3-H	P30X30200ST-H		80 €		
	P30X3001	P30X3001			85 €	
	P30X3002	P30X3002				91 €
Plata Prata	P30X30ST3-J			69 €		
	P30X3001				73 €	
	P30X3002					78 €

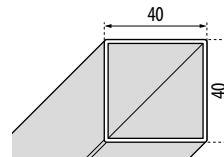

LUNES / STAR 2.0 H 195 cm
ZEPHYROS 2.0 H 200 cm
STAR H 185 cm

Color Cores	Código			medida altura (max 200 cm)		
	LUNES STAR 2.0	ZEPHYROS 2.0	STAR	Standard	Especial	
					<190	>190
Blanco Branco	P40X40ST3-A	P40X40ST2-U	P40X40ST1-A	67 €		
	P40X4001	P40X4001	P40X4001		72 €	
	P40X4002	P40X4002	P40X4002			76 €
Silver Brillantado	P40X40ST3-B	P40X40ST2-B	P40X40ST1-B	74 €		
	P40X4001	P40X4001	P40X4001		80 €	
	P40X4002	P40X4002	P40X4002			85 €
Cromo	P40X40ST3-K	P40X40ST2-K		83 €		
	P40X4001	P40X4001			88 €	
	P40X4002	P40X4002				94 €
Negro mate	P40X40ST3-H	P40X40ST2-H		83 €		
	P40X4001	P40X4001			88 €	
	P40X4002	P40X4002				94 €
Plata Prata	P40X40ST3-J			71 €		
	P40X4001				76 €	
	P40X4002					82 €

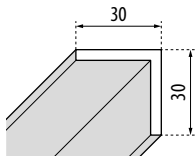

LUNES / STAR 2.0 H 195 cm
ZEPHYROS 2.0 H 200 cm
STAR H 185 cm

Color Cores	Código			medida altura (max 200 cm)		
	LUNES STAR 2.0	ZEPHYROS 2.0	STAR	Standard	Especial	
					<190	>190
Blanco Branco	L30X30ST3-A	L30X30ST2-U	L30X30ST1-A	59 €		
	L30X3001	L30X3001	L30X3001		64 €	
	L30X3002	L30X3002	L30X3002			68 €
Silver Brillantado	L30X30ST3-B	L30X30ST2-B	L30X30ST1-B	66 €		
	L30X3001	L30X3001	L30X3001		70 €	
	L30X3002	L30X3002	L30X3002			75 €
Cromo	L30X30ST3-K	L30X30ST2-K		73 €		
	L30X3001	L30X3001			78 €	
	L30X3002	L30X3002				84 €
Negro mate	L30X30ST3-H	L30X30ST2-H		73 €		
	L30X3001	L30X3001			78 €	
	L30X3002	L30X3002				84 €
Plata Prata	L30X30ST3-J			64 €		
	L30X3001				68 €	
	L30X3002					72 €

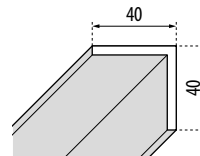

LUNES / STAR 2.0 H 195 cm
ZEPHYROS 2.0 H 200 cm
STAR H 185 cm

Color Cores	Código			medida altura (max 200 cm)		
	LUNES STAR 2.0	ZEPHYROS 2.0	STAR	Standard	Especial	
					<190	>190
Blanco Branco	L40X40ST3-A	L40X40ST2-U	L40X40ST1-A	61 €		
	L40X4001	L40X4001	L40X4001		66 €	
	L40X4002	L40X4002	L40X4002			70 €
Silver Brillantado	L40X40ST3-B	L40X40ST2-B	L40X40ST1-B	69 €		
	L40X4001	L40X4001	L40X4001		73 €	
	L40X4002	L40X4002	L40X4002			78 €
Cromo	L40X40ST3-K	L40X40ST2-K		76 €		
	L40X4001	L40X4001			82 €	
	L40X4002	L40X4002				87 €
Negro mate	L40X40ST3-H	L40X40ST2-H		76 €		
	L40X4001	L40X4001			82 €	
	L40X4002	L40X4002				87 €
Plata Prata	L40X40ST3-J			66 €		
	L40X4001				71 €	
	L40X4002					75 €

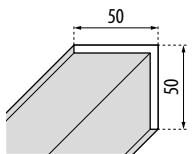

LUNES / STAR 2.0 H 195 cm
ZEPHYROS 2.0 H 200 cm
STAR H 185 cm

Color Cores	Código			medida altura (max 200 cm)		
	LUNES STAR 2.0	ZEPHYROS 2.0	STAR	Standard	Especial	
					<190	>190
Blanco Branco	L50X50ST3-A	L50X50ST2-U	L50X50ST1-A	59 €		
	L50X5001	L50X5001	L50X5001		64 €	
	L50X5002	L50X5002	L50X5002			68 €
Silver Brillantado	L50X50ST3-B	L50X50ST2-B	L50X50ST1-B	66 €		
	L50X5001	L50X5001	L50X5001		70 €	
	L50X5002	L50X5002	L50X5002			75 €
Cromo	L50X50ST3-K	L50X50ST2-K		73 €		
	L50X5001	L50X5001			78 €	
	L50X5002	L50X5002				84 €
Negro mate	L50X50ST3-H	L50X50ST2-H		73 €		
	L50X5001	L50X5001			78 €	
	L50X5002	L50X5002				84 €
Plata Prata	L50X50ST3-J			64 €		
	L50X5001				68 €	
	L50X5002					72 €

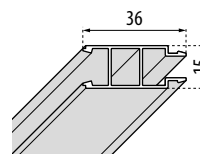

LUNES / STAR 2.0 H 195 cm
ZEPHYROS 2.0 H 200 cm
STAR H 185 cm

Color Cores	Código			medida altura (max 200 cm)		
	LUNES STAR 2.0	ZEPHYROS 2.0	STAR	Standard	Especial	
					<190	>190
Blanco Branco	P05HAAST3-A	P05HAAST2-U	P05HAAST1-A	68 €		
	P05HAA01	P05HAA01	P05HAA01		72 €	
	P05HAA02	P05HAA02	P05HAA02			77 €
Silver Brillantado	P05HAAST3-B	P05HAAST2-B	P05HAAST1-B	75 €		
	P05HAA01	P05HAA01	P05HAA01		81 €	
	P05HAA02	P05HAA02	P05HAA02			86 €
Cromo	P05HAAST3-K	P05HAAST2-K		84 €		
	P05HAA01	P05HAA01			90 €	
	P05HAA02	P05HAA02				95 €
Negro mate	P05HAAST3-H	P05HAAST2-H		84 €		
	P05HAA01	P05HAA01			90 €	
	P05HAA02	P05HAA02				95 €
Plata Prata	P05HAAST3-J			72 €		
	P05HAA01				77 €	
	P05HAA02					83 €

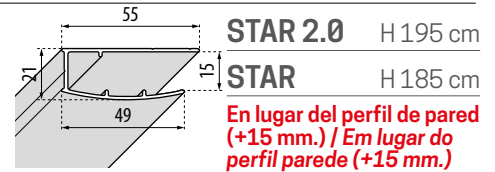
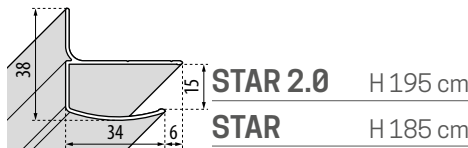
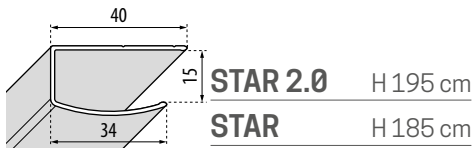

Color Cores	Código		medida altura (max 200 cm)	
	STAR 2.0	STAR	Standard	Especial
Blanco Branco	P01HAAST3-A	P01HAAST1-A	73 €	
	P01HAA01	P01HAA01		78 €
	P01HAA02	P01HAA02		83 €
Silver Abrilantado	P01HAAST3-B	P01HAAST1-B	82 €	
	P01HAA01	P01HAA01		87 €
	P01HAA02	P01HAA02		92 €

Color Cores	Código		medida altura (max 200 cm)	
	STAR	STAR 2.0	Standard	Especial
Blanco Branco	P01HAPST1-A	P01HAPST3-A	73 €	
	P01HAP01	P01HAP01		78 €
	P01HAP02	P01HAP02		83 €
Silver Abrilantado	P01HAPST1-B	P01HAPST3-B	82 €	
	P01HAP01	P01HAP01		87 €
	P01HAP02	P01HAP02		92 €

Color Cores	Código		medida altura (max 200 cm)	
	STAR	STAR 2.0	Standard	Especial
Blanco Branco	P01SACST1-A	P01SACST3-A	77 €	
	P01SAC01	P01SAC01		83 €
	P01SAC02	P01SAC02		88 €
Silver Abrilantado	P01SACST1-B	P01SACST3-B	86 €	
	P01SAC01	P01SAC01		92 €
	P01SAC02	P01SAC02		98 €

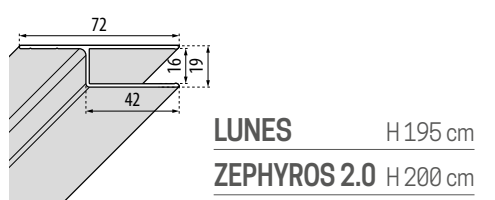
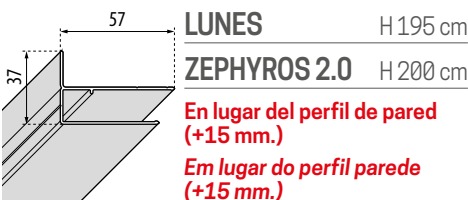
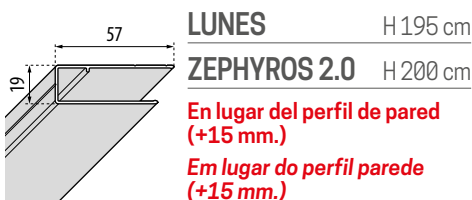

Color Cores	Código		medida altura (max 200 cm)	
	LUNES	ZEPHYROS 2.0	Standard	Especial
Blanco Branco	P05BHST-A	P05BHST2-U	78 €	
	P05BH01	P05BH01		84 €
	P05BH02	P05BH02		89 €
Silver Abrilantado	P05BHST-B	P05BHST2-B	87 €	
	P05BH01	P05BH01		93 €
	P05BH02	P05BH02		99 €
Cromo	P05BHST-K	P05BHST2-K	96 €	
	P05BH01	P05BH01		103 €
	P05BH02	P05BH02		110 €
Negro mate	P05BHST-H	P05BHST2-H	96 €	
	P05BH01	P05BH01		103 €
	P05BH02	P05BH02		110 €
Plata Prata	P05BHST-J		84 €	
	P05BH01			89 €
	P05BH02			95 €

Color Cores	Código		medida altura (max 200 cm)	
	LUNES	ZEPHYROS 2.0	Standard	Especial
Blanco Branco	P05BHCST-A	P05BHCST2-U	82 €	
	P05BHC01	P05BHC01		87 €
	P05BHC02	P05BHC02		93 €
Silver Abrilantado	P05BHCST-B	P05BHCST2-B	91 €	
	P05BHC01	P05BHC01		96 €
	P05BHC02	P05BHC02		103 €
Cromo	P05BHCST-K	P05BHCST2-K	101 €	
	P05BHC01	P05BHC01		108 €
	P05BHC02	P05BHC02		114 €
Negro mate	P05BHCST-H	P05BHCST2-H	101 €	
	P05BHC01	P05BHC01		108 €
	P05BHC02	P05BHC02		114 €
Plata Prata	P05BHCST-J		87 €	
	P05BHC01			93 €
	P05BHC02			100 €

Color Cores	Código		medida altura (max 200 cm)	
	LUNES	ZEPHYROS 2.0	Standard	Especial
Blanco Branco	P01L215STL-A	P01L215STL2-U	92 €	
	P01L215002SP	P01L215002SP		99 € 105 €
Silver Abril.	P01L215STL-B	P01L215STL2-B	102 €	
	P01L215002SP	P01L215002SP		109 € 117 €
Cromo	P01L215STL-K	P01L215STL2-K	113 €	
	P01L215002SP	P01L215002SP		121 € 129 €
Negro mate	P01L215STL-H	P01L215STL2-H	113 €	
	P01L215002SP	P01L215002SP		121 € 129 €
Plata Prata	P01L215STL-J		98 €	
	P01L215002SP			105 € 111 €



Color Cores	Código		medida altura (max 200 cm)	
	ZEPHYROS 2.0	Standard	Especial	
Blanco Branco	P01BHRAST2-U	72 €		
	P01BHRA01		77 €	
	P01BHRA02			83 €
Silver Abrilantado	P01BHRAST2-B	81 €		
	P01BHRA01		86 €	
	P01BHRA02			91 €
Cromo	P01BHRAST2-K	89 €		
	P01BHRA01		95 €	
	P01BHRA02			102 €
Negro mate	P01BHRAST2-H	89 €		
	P01BHRA01		95 €	
	P01BHRA02			102 €

Color Cores	Código		medida altura (max 200 cm)	
	ZEPHYROS 2.0	Standard	Especial	>195
Blanco Branco	P01BHMOST2-U	74 €		
	P01BHM001		80 €	
	P01BHM002			85 €
Silver Abrilantado	P01BHMOST2-B	83 €		
	P01BHM001		89 €	
	P01BHM002			94 €
Cromo	P01BHMOST2-K	92 €		
	P01BHM001		99 €	
	P01BHM002			105 €
Negro mate	P01BHMOST2-H	92 €		
	P01BHM001		99 €	
	P01BHM002			105 €

Color Cores	Código		medida altura (max 200 cm)
	LUNES H	GIADA H	Standard
Blanco Branco	P01LGHST-A	P01LGHST-A	75 €
Silver Abrilantado Cromo	P01LGHST-B	P01LGHST-B	84 €
	P01LGHST-K	P01LGHST-K	93 €

PERFILES / PERFÍS PARA MAMPARAS / PARA RESGUARDOS

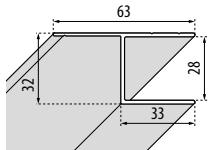

YOUNG H 198,4 cm

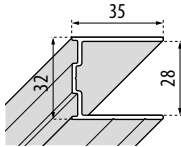

YOUNG H 200 cm

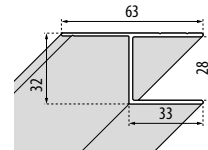

YOUNG H 200 cm

Color Cores	Código	medida altura (max 200 cm)	
		Standard	Especial
Blanco mate	P01Y2MOBSTL-U	123 €	
Branco mate	P01Y2MOB002SP		131 € 131 €
Silver	P01Y2MOBSTL-B	136 €	
Abrillantado	P01Y2MOB002SP		144 € 144 €
Cromo	P01Y2MOBSTL-K	149 €	
	P01Y2MOB002SP		160 € 160 €
Negro mate	P01Y2MOBSTL-H	149 €	
	P01Y2MOB002SP		160 € 160 €
Inox satinado	P01Y2MOBSTL-Z	180 €	
	P01Y2MOB002SP		193 € 193 €

Color Cores	Código	medida altura (max 200 cm)	
		Fisso (H 198,4)	Puerta/Porta (H 200)
Blanco	P01BNMOAST-U		120 €
Branco	P01BNMOBST-U	120 €	
Silver	P01BNMOAST-B		134 €
Abrillantado	P01BNMOBST-B	134 €	
Cromo	P01BNMOAST-K		148 €
	P01BNMOBST-K	148 €	
Negro mate	P01BNMOAST-H		148 €
	P01BNMOBST-H	148 €	
Inox satinado	P01BNMOAST-Z		178 €
	P01BNMOBST-Z	178 €	

Color Cores	Código	medida altura (max 200 cm)	
		Standard	Especial
Blanco mate	P01Y2MOASTL-U	123 €	
Branco mate	P01Y2MOA002SP		131 € 131 €
Silver	P01Y2MOASTL-B	136 €	
Abrillantado	P01Y2MOA002SP		144 € 144 €
Cromo	P01Y2MOASTL-K	149 €	
	P01Y2MOA002SP		160 € 160 €
Negro mate	P01Y2MOASTL-H	149 €	
	P01Y2MOA002SP		160 € 160 €
Inox satinado	P01Y2MOASTL-Z	180 €	
	P01Y2MOA002SP		193 € 193 €

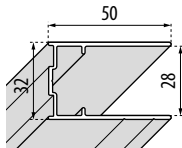

YOUNG H 200 cm

En lugar del perfil de pared (+15 mm.) / Em lugar do perfil parede (+15 mm.)

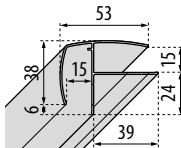

STAR 2.0 H 195 cm

STAR H 185 cm

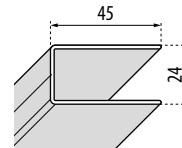

KUADRA H H 200 cm

Color Cores	Código	medida altura (max 200 cm)		
		Fisso (H 198,4)	Puerta/Porta (H 200)	Da 140 a 200
Blanco	P05Y2ST-U	98 €		
	P05Y2ST2-U		104 €	
	P05Y2SP			110 €
Silver	P05Y2ST-B	108 €		
	P05Y2ST2-B		116 €	
	P05Y2SP			123 €
Cromo	P05Y2ST-K	120 €		
	P05Y2ST2-K		124 €	
	P05Y2SP			133 €
Negro mate	P05Y2ST-H	120 €		
	P05Y2ST2-H		128 €	
	P05Y2SP			137 €
Inox satinado	P05Y2ST-Z	144 €		
	P05Y2ST2-Z		154 €	
	P05Y2SP			164 €

Color Cores	Código		medida altura (max 200 cm)	
	STAR	STAR 2.0	Standard	Especial
Blanco	P05HAFST1-A	P05HAFST3-A	68 €	
	P05HAF01	P05HAF01		72 €
Branco	P05HAF02	P05HAF02		77 €
	P05HAFST1-B	P05HAFST3-B	75 €	
Silver	P05HAF01	P05HAF01		81 €
	P05HAF02	P05HAF02		86 €

Color Cores	Código	medida altura (max 200 cm)
		Standard
Blanco / Branco	P01KUHST-U	87 €
Silver / Abrillantado	P01KUHST-B	96 €
Cromo	P01KUHST-K	107 €
Negro mate	P01KUHST-H	107 €
Inox satinado	P01KUHST-Z	128 €

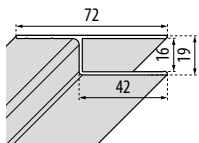

FREE 2 H 190 cm

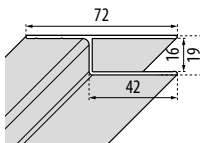

FREE 2 H 85 cm

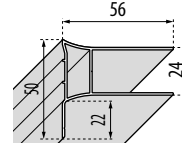

ROSE ROSSE H 200 cm

En lugar del perfil de pared (+15 mm.)

Em lugar do perfil parede (+15 mm.)

Color Cores	Código	medida altura (max 200 cm)	
		Standard	Especial
Blanco	P01FR215ASTL-A	83 €	
	P01FR215002SP		89 € 89 €
Silver	P01FR215ASTL-B	92 €	
Abrillantado	P01FR215002SP		99 € 99 €

Color Cores	Código	medida altura (max 200 cm)	
		Standard	Especial
Blanco	P01FR215BSTL-A	83 €	
	P01FR215002SP		89 € 89 €
Silver	P01FR215BSTL-B	92 €	
Abrillantado	P01FR215002SP		99 € 99 €

Color Cores	Código	medida altura (max 200 cm)
		Standard
Blanco / Branco	P05ROSCST-A	88 €
Silver / Abrillantado	P05ROSCST-B	98 €
Cromo	P05ROSCST-K	108 €

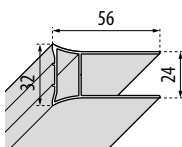

ROSE ROSSE H 200 cm

En lugar del perfil de pared (+15 mm.)

Em lugar do perfil parede (+15 mm.)

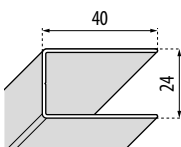

ROSE ROSSE H 200 cm

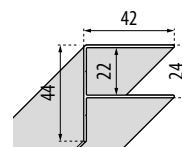

ROSE ROSSE H 200 cm

Color Cores	Código	medida altura (max 200 cm)
		Standard
Blanco	P05ROSST-A	84 €
Branco	P05ROSST-A	84 €
Silver	P05ROSST-B	93 €
Abrillantado	P05ROSST-B	93 €
Cromo	P05ROSST-K	104 €

Color Cores	Código	medida altura	
		Standard	Especial
Blanco	P01BEAST-A	61 €	
	P01BEASP		66 €
Silver	P01BEAST-B	69 €	
	P01BEASP		73 €
Cromo	P01BEAST-K	76 €	
	P01BEASP		82 €

Color Cores	Código	medida altura (max 200 cm)	
		Standard	Especial
Blanco	P01BEGST-A	70 €	
	P01BEGSP		74 €
Silver	P01BEGST-B	77 €	
	P01BEGSP		83 €
Cromo	P01BEGST-K	86 €	
	P01BEGSP		92 €

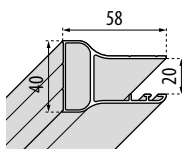

LOUVRE H 195 cm

En lugar del perfil de pared (+15 mm.) / Em lugar do perfil parede (+15 mm.)

Color Cores	Código	medida altura (max 200 cm)		
		Standard	Especial	
LOUVRE	<195		>195	
Silver Abrillantado	P05BI2MOST-B	121 €		
	P04DIA01		129 €	
	P04DIA02			138 €
Cromo	P05BI2MOST-K	135 €		
	P04DIA01		144 €	
	P04DIA02			154 €

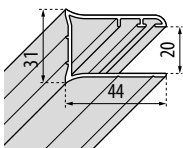

LOUVRE H 195 cm

Color Cores	Código	medida altura (max 200 cm)		
		Standard	Especial	
LOUVRE	<195		>195	
Silver Abrillantado	P01BI2MOST-B	102 €		
	P02DIA01		109 €	
Cromo	P01BI2MOST-K	113 €		
	P02DIA01		121 €	

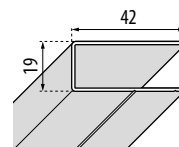

LUNES H 195 cm

Color Cores	Código	medida altura (max 200 cm)		
		Standard	Especial	
LUNES	<195		>195	
Blanco Branco	P01BJMOST-A	72 €		
	P01BJMOSP		77 €	
Silver Abrillantado	P01BJMOST-B	81 €		
	P01BJMOSP		86 €	
Cromo	P01BJMOST-K	89 €		
	P01BJMOSP		95 €	
Plata Prata	P01BJMOST-J	77 €		
	P01BJMOSP		83 €	

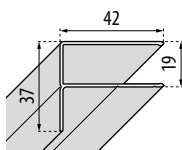

LUNES H 195 cm

Color Cores	Código	medida altura (max 200 cm)		
		Standard	Especial	
LUNES	<195		>195	
Blanco Branco	P01BJGBST-A	74 €		
	P01BJGBSP		80 €	85 €
Silver Abrillantado	P01BJGBST-B	83 €		
	P01BJGBSP		89 €	94 €
Cromo	P01BJGBST-K	92 €		
	P01BJGBSP		99 €	105 €
Plata Prata	P01BJGBST-J	80 €		
	P01BJGBSP		85 €	91 €

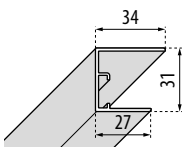

KUADRA 2.0 H 200 cm

Color Cores	Código	medida altura 200 cm	
		Standard	Especial
KUADRA 2.0		Standard	
Blanco mate Branco mate	P01BWMOST-U	118 €	
Silver Abrillantado	P01BWMOST-B	127 €	
Negro mate	P01BWMOST-H	139 €	
Cromo	P01BWMOST-K	139 €	
Inox satinado	P01BWMOST-Z	167 €	

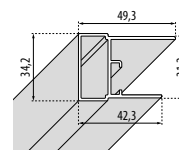

KUADRA 2.0 H 200 cm

En lugar del perfil de pared (+15 mm.) / Em lugar do perfil parede (+15 mm.)

Color Cores	Código	medida altura (max 200 cm)		
		Standard	Especial	
KUADRA 2.0	<200		>200	
Blanco mate Branco mate	P05BWMOST-U	109 €		
	P05BWMOSP		117 €	
Silver Abrillantado	P05BWMOST-B	121 €		
	P05BWMOSP		129 €	
Cromo	P05BWMOST-K	135 €		
	P05BWMOSP		144 €	
Negro mate	P05BWMOST-H	135 €		
	P05BWMOSP		144 €	
Inox satinado	P05BWMOST-Z	161 €		
	P05BWMOSP		173 €	

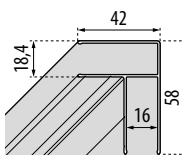

LUNES H 195 cm

STAR 2.0 H 195 cm

Color Cores	Código	medida altura (max 200 cm)		
		Standard	Especial	
LUNES STAR 2.0	<195		>195	
Blanco Branco	P05BJFST-A	68 €		
	P05BJFSP		72 €	77 €
Silver Abrillantado	P05BJFST-B	75 €		
	P05BJFSP		81 €	86 €
Cromo	P05BJFST-K	84 €		
	P05BJFSP		90 €	95 €
Plata Prata	P05BJFST-J	72 €		
	P05BJFSP		77 €	83 €

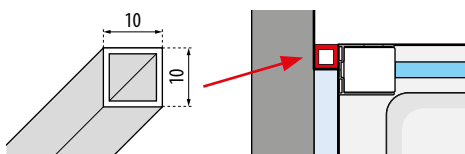

Color Cores	Código	medida altura 200 cm	
		Standard	Especial
PROFILI TUBOLARI		Standard	
Blanco mate Branco mate	P10X10ST2-U	66 €	
Silver Abrillantado	P10X10ST2-B	69 €	
Cromo	P10X10ST2-K	76 €	
Negro mate	P10X10ST2-H	76 €	
Plata Prata	P10X10ST2-J	66 €	
Inox satinado	P10X10ST2-Z	91 €	

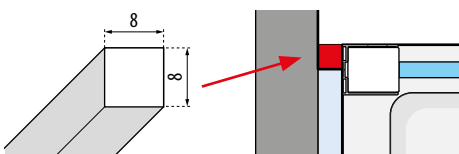

Color Cores	Código	medida altura 200 cm	
		Standard	Especial
PROFILI TUBOLARI		Standard	
Blanco mate Branco mate	P08X08ST2-U	66 €	
Silver Abrillantado	P08X08ST2-B	69 €	
Cromo	P08X08ST2-K	76 €	
Negro mate	P08X08ST2-H	76 €	
Plata Prata	P08X08ST2-J	66 €	
Inox satinado	P08X08ST2-Z	91 €	

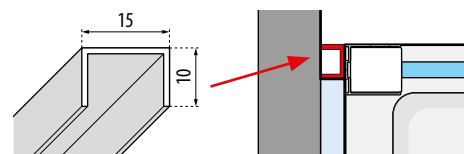

Color Cores	Código	medida altura 200 cm	
		Standard	Especial
Profili di contenimento		Standard	
Blanco mate Branco mate	P51U1510ST2-U	86 €	
Silver Abrillantado	P51U1510ST2-B	91 €	
Cromo	P51U1510ST2-K	101 €	
Negro mate	P51U1510ST2-H	101 €	
Plata Prata	P51U1510ST2-J	87 €	
Inox satinado	P51U1510ST2-Z	121 €	

ACCESORIOS FRAME

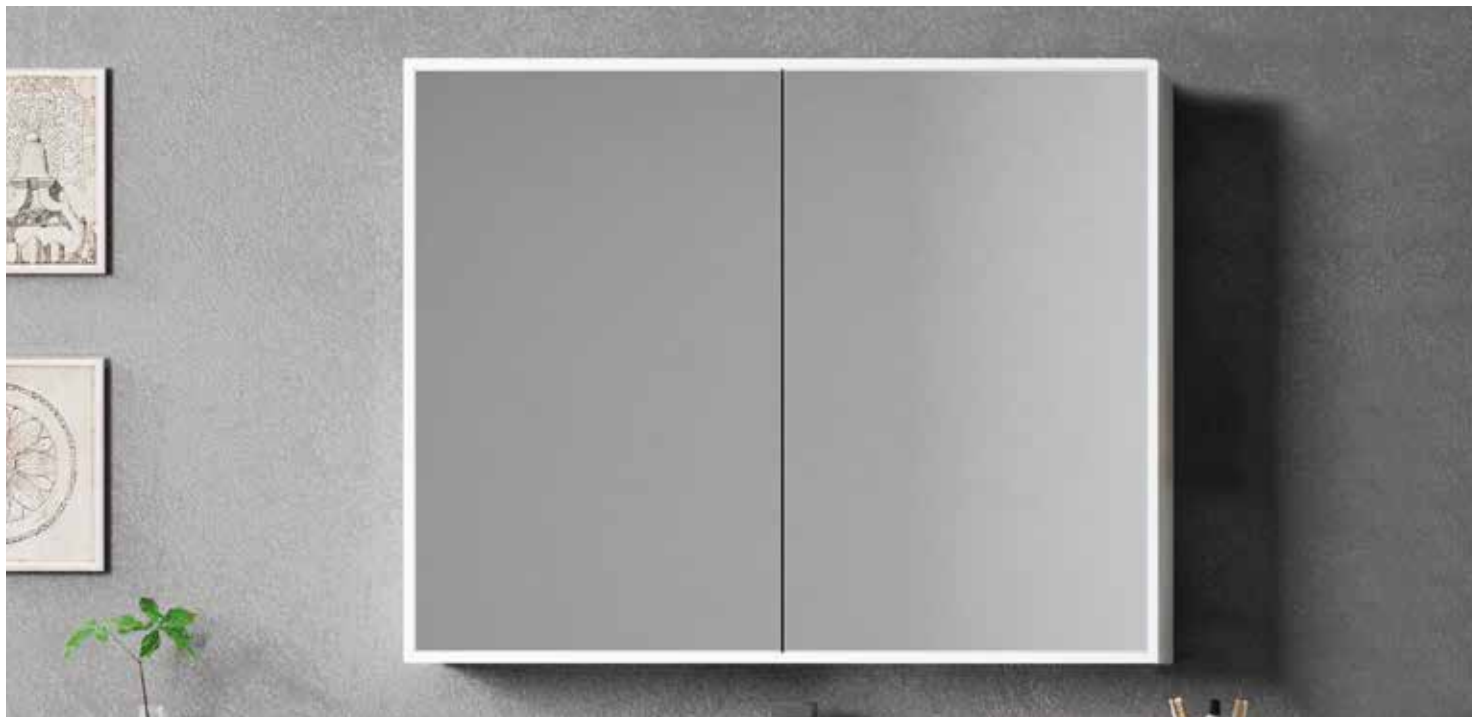

CONTENEDOR ESPEJOS ESTRUCTURA ALUMINIO 14 CM PROFUNDIDAD SIN ILUMINACIÓN

ESPELHOS "SLIDE" COM MOLDURA DE ALUMÍNIO COM 14 CM DE PROFUNDIDADE SEM ILUMINAÇÃO

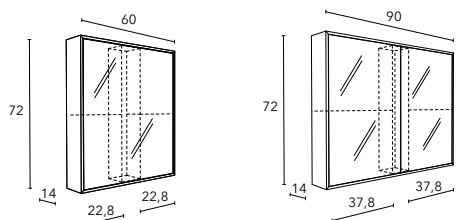

una puerta de espejo
uma porta-espelho

dos puertas de espejo
duas portas espelhadas

"SLIDE" CONTENEDOR ESPEJOS ESTRUCTURA ALUMINIO 14 CM PROFUNDIDAD CON KIT LUZ

EL KIT DE ILUMINACIÓN INCLUYE: iluminación LED interior, 1 enchufe shuko, 1 interruptor táctil ON/OFF + dimmer

O KIT LIGHT INCLUI: iluminação interior LED, 1 tomada shuko, 1 interruptor de toque ON/OFF + dimmer

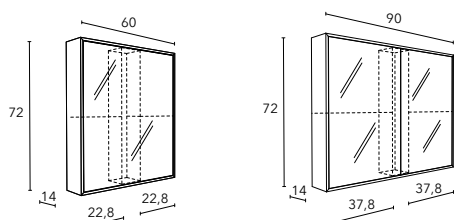

una puerta de espejo
uma porta-espelho

dos puertas de espejo
duas portas espelhadas

Medidas				Código	Precio / Preço		
altura	Ancho del espejo	Ancho de la puerta	U		B	H	
					Blanco Branco	Silver Abrillantado	Negro
UNA PUERTA DE ESPEJO SIN RESPALDO							
72	60	60	Bisagras a la derecha	D4EPM8S6	729 €	729 €	729 €
72	60	60	Bisagras a la izquierda	S4EPM8S6	729 €	729 €	729 €
UNA PUERTA CON RESPALDO DE ESPEJO							
72	60	60	Bisagras a la derecha	D4EPP8S6	858 €	858 €	858 €
72	60	60	Bisagras a la izquierda	S4EPP8S6	858 €	858 €	858 €
UNA PUERTA DE ESPEJO SIN RESPALDO							
72	90	45X2	-	L4EPM9Z6	879 €	879 €	879 €
UN'ANTA A SPECCHIO CON SCHIENA A SPECCHIO							
72	90	45X2	-	L4EPP9Z6	1.042 €	1.042 €	1.042 €

Medidas				Código	Precio / Preço		
altura	Ancho del espejo	Ancho de la puerta	U		B	H	
					Blanco Branco	Silver Abrillantado	Negro
UNA PUERTA DE ESPEJO SIN RESPALDO							
72	60	60	Bisagras a la derecha	D4EPN8S6	901 €	901 €	901 €
72	60	60	Bisagras a la izquierda	S4EPN8S6	901 €	901 €	901 €
UNA PUERTA CON RESPALDO DE ESPEJO							
72	60	60	Bisagras a la derecha	D4EPQ8S6	1.046 €	1.046 €	1.046 €
72	60	60	Bisagras a la izquierda	S4EPQ8S6	1.046 €	1.046 €	1.046 €
DOS PUERTAS DE ESPEJO SIN RESPALDO							
72	90	45X2	-	L4EPN9Z6	1.052 €	1.052 €	1.052 €
DOS PUERTAS CON RESPALDO DE ESPEJO							
72	90	45X2	-	L4EPQ9Z6	1.232 €	1.232 €	1.232 €

Bajo pedido 2 estantes interiores de cristal: recargo € 53

A pedido 2 prateleiras de vidro internas: sobretaxa de € 53.

Bajo pedido preparación para luz superior con interruptor interno: recargo € 22

Arranjo a pedido para lâmpada superior com interruptor interno: sobretaxa de € 22

Opcional: KIT DE SONIDO BLUETOOTH para insertar sólo en los retrovisores contenedores con kit de luz € 265

Opcional: KIT DE SOM BLUETOOTH para inserção apenas em espelhos de contentores com kit de luz € 265





CONTENEDOR ESPEJOS ESTRUCTURA ALUMINIO 14 CM PROFUNDIDAD SIN ILUMINACIÓN
ESPELHOS "SLIDE" COM MOLDURA DE ALUMÍNIO COM 14 CM DE PROFUNDIDADE SEM ILUMINAÇÃO

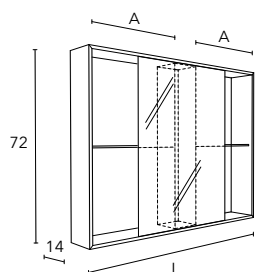

A Compartimento útil
 (90) (120) (150) (180)
38,4 53,4 68,4 83,4

"SLIDE" CONTENEDOR ESPEJOS ESTRUCTURA ALUMINIO 14 CM PROFUNDIDAD CON KIT LUZ
ESPELHOS "SLIDE" COM MOLDURA DE ALUMÍNIO DE 14 CM DE PROFUNDIDADE COM KIT DE LUZ

EL KIT DE ILUMINACIÓN INCLUYE: iluminación LED interior, 1 enchufe shuko, 1 interruptor táctil ON/OFF + dimmer

O KIT LIGHT INCLUI: iluminação interior LED, 1 tomada shuko, 1 interruptor de toque ON/OFF + dimmer

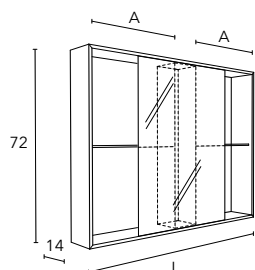

A Compartimento útil
 (90) (120) (150) (180)
38,4 53,4 68,4 83,4

Medidas			Código	Precio / Preço		
altura	Ancho del espejo	Ancho de la puerta		U Blanco Branco	B Silver Abrillantado	H Negro

SIN RESPALDO						
72	90	51	L4EPMRZ6	827 €	827 €	827 €
72	120	66	L4EPMRQ6	859 €	859 €	859 €
72	150	81	L4EPMRW6	896 €	896 €	896 €
72	180	96	L4EPMRY6	933 €	933 €	933 €

CON REVERSO DE ESPEJO						
72	90	51	L4EPPRZ6	896 €	896 €	896 €
72	120	66	L4EPPRQ6	945 €	945 €	945 €
72	150	81	L4EPPRW6	999 €	999 €	999 €
72	180	96	L4EPPRY6	1.145 €	1.145 €	1.145 €

Medidas			Código	Precio / Preço		
altura	Ancho del espejo	Ancho de la puerta		U Blanco Branco	B Silver Abrillantado	H Negro

SIN RESPALDO						
72	90	51	L4EPNRZ6	997 €	997 €	997 €
72	120	66	L4EPNRQ6	997 €	997 €	997 €
72	150	81	L4EPNRW6	1.066 €	1.066 €	1.066 €
72	180	96	L4EPNRY6	1.103 €	1.103 €	1.103 €

CON REVERSO DE ESPEJO						
72	90	51	L4EPQRZ6	1.066 €	1.066 €	1.066 €
72	120	66	L4EPQRQ6	1.115 €	1.115 €	1.115 €
72	150	81	L4EPQRW6	1.169 €	1.169 €	1.169 €
72	180	96	L4EPQRY6	1.315 €	1.315 €	1.315 €

Bajo pedido 2 estantes interiores de cristal: recargo € 53
 A pedido 2 prateleiras de vidro internas: sobretaxa de € 53.

Bajo pedido preparación para luz superior con interruptor interno: recargo € 22

Arranjo a pedido para lâmpada superior com interruptor interno: sobretaxa de € 22

Opcional: KIT DE SONIDO BLUETOOTH para insertar sólo en los retrovisores contenedores con kit de luz € 265

Opcional: KIT DE SOM BLUETOOTH para inserção apenas em espelhos de contentores com kit de luz € 265



ACCESORIOS **FRAME**

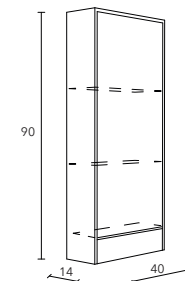

una puerta
uma porta

MUEBLE DE PARED DE 14 CM DE PROFUNDIDAD / UNIDADE DE PAREDE COM 14 CM DE PROFUNDIDADE

Medidas			Código	Anta					Estructura		
				Acabado de la puerta					Elección de perfil		
				00	U	R	O	S	U	B	H
				espejo espelho	Blanco mate	Ceniza	Polvo	Tortola	Blanco Branco	Silver Abrillantado	Negro
SIN RESPALDO											
40	40	Bisagras a la derecha	D4EPZ1D7	516 €	587 €	664 €	664 €	664 €			
CON REVERSO DE ESPEJO											
40	40	Bisagras a la izquierda	S4EPZ1D7	516 €	587 €	664 €	664 €	664 €			



“SLIDE” ESPEJOS DE ALMACENAMIENTO VERTICAL CON PUERTA DE ESPEJO COMPLETA DE 18 CM DE PROFUNDIDAD
ESPELHOS 'SLIDE' DE ARRUMAÇÃO VERTICAL COM PORTA ESPELHO COMPLETA 18 CM DE PROFUNDIDADE

Medidas			Código	Selección de color Seleção de cores de acabados									Selección del color del perfil		
altura	ancho			A	U	I	N	M	X	R	O	S	U	B	H
				Blanco brillo Branco brilho	Blanco mate	Blanco rayado Branco listrado	Burlington	Grain	Dolomite	Ceniza	Polvo	Tortora	Blanco mate	Silver Abrillantado	Negro
58	45	Bisagras a la derecha	D4EPD6JN	618 €	618 €	618 €	618 €	618 €	618 €	689 €	689 €	689 €			
58	45	Bisagras a la izquierda	S4EPD6JN	618 €	618 €	618 €	618 €	618 €	618 €	689 €	689 €	689 €			
82	45	Bisagras a la derecha	D4EPD6J6	674 €	674 €	674 €	674 €	674 €	674 €	757 €	757 €	757 €			
82	45	Bisagras a la izquierda	S4EPD6J6	674 €	674 €	674 €	674 €	674 €	674 €	757 €	757 €	757 €			
94	45	Bisagras a la derecha	D4EPD6J8	746 €	746 €	746 €	746 €	746 €	746 €	836 €	836 €	836 €			
94	45	Bisagras a la izquierda	S4EPD6J8	746 €	746 €	746 €	746 €	746 €	746 €	836 €	836 €	836 €			
130	45	Bisagras a la derecha	D4EPD6JC	855 €	855 €	855 €	855 €	855 €	855 €	958 €	958 €	958 €			
130	45	Bisagras a la izquierda	S4EPD6JC	855 €	855 €	855 €	855 €	855 €	855 €	958 €	958 €	958 €			

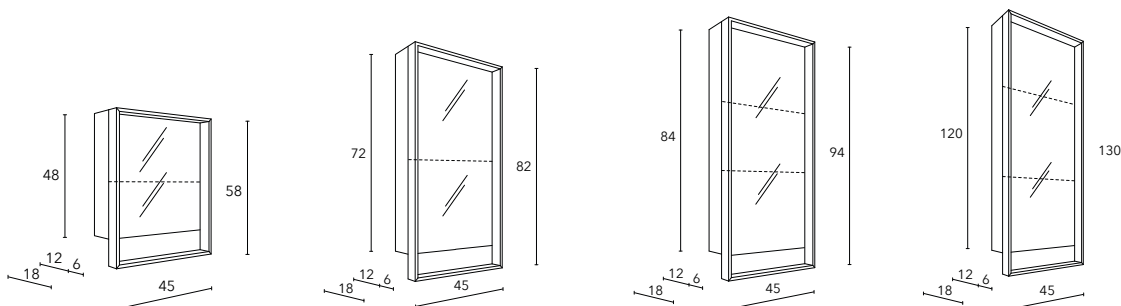

ACCESORIOS FRAME



ESPEJOS RETROILUMINADOS A TRES CARAS POR LUZ LED (sin cara inferior)

El espejo puede colocarse en posición VERTICAL. Especifíquelo en el pedido.

LUZES DE LUZ DE VOLTA LUZES TRÊS LADOS (sem lado inferior)

O espelho pode ser posicionado VERTICAL. Por favor especifique quando encomendar.

Altura 52 cm

altura	ancho	Código	Precio Preço
52	60	L4ESA16000	355 €
52	70	L4ESA17000	361 €
52	80	L4ESA18000	368 €
52	90	L4ESA19000	375 €
52	100	L4ESA1A100	418 €
52	105	L4ESA1A600	454 €
52	110	L4ESA1B200	457 €
52	120	L4ESA1C300	465 €
52	130	L4ESA1D400	469 €
52	140	L4ESA1E500	473 €
52	150	L4ESA1F600	479 €
52	160	L4ESA1G700	484 €
52	170	L4ESA1H800	489 €
52	180	L4ESA1J900	493 €

Altura 72 cm

altura	ancho	Código	Precio Preço
72	60	L4ESA26000	364 €
72	70	L4ESA27000	374 €
72	80	L4ESA28000	427 €
72	90	L4ESA29000	461 €
72	100	L4ESA2A100	467 €
72	105	L4ESA2A600	471 €
72	110	L4ESA2B200	473 €
72	120	L4ESA2C300	483 €
72	130	L4ESA2D400	491 €
72	140	L4ESA2E500	524 €
72	150	L4ESA2F600	536 €
72	160	L4ESA2G700	554 €
72	170	L4ESA2H800	573 €
72	180	L4ESA2J900	592 €

Altura 84 cm

altura	ancho	Código	Precio Preço
84	60	L4ESA36000	374 €
84	70	L4ESA37000	426 €
84	80	L4ESA38000	462 €
84	90	L4ESA39000	470 €
84	100	L4ESA3A100	476 €
84	105	L4ESA3A600	480 €
84	110	L4ESA3B200	485 €
84	120	L4ESA3C300	494 €
84	130	L4ESA3D400	529 €
84	140	L4ESA3E500	537 €
84	150	L4ESA3F600	554 €
84	160	L4ESA3G700	573 €
84	170	L4ESA3H800	592 €
84	180	L4ESA3J900	609 €

* Para espejos de ancho especial incrementar 25% sobre la medida inferior. Ancho máximo 200 cm.

* Para espelhos de largura especial, aumentar 25% na medida inferior. Largura máxima 200 cm.



ESPEJOS RETROILUMINADOS POR LEDS A TRES CARAS CON ESTANTE INFERIOR DE ALUMINIO DE 14 CM DE PROFUNDIDAD
ESPELHOS RETRO-ILUMINADOS DE TRÊS LADOS COM PRATELEIRA INFERIOR EM ALUMÍNIO COM 14 CM DE PROFUNDIDADE

Altura 52 cm

ancho	Código	Elección de perfil		
		U	B	H
		Blanco mate Branco mate	Silver Abrillantado	Negro mate
60	L4ESB16000	464 €	464 €	464 €
70	L4ESB17000	474 €	474 €	474 €
80	L4ESB18000	488 €	488 €	488 €
90	L4ESB19000	499 €	499 €	499 €
100	L4ESB1A100	541 €	541 €	541 €
105	L4ESB1A600	586 €	586 €	586 €
110	L4ESB1B200	591 €	591 €	591 €
120	L4ESB1C300	605 €	605 €	605 €
130	L4ESB1D400	612 €	612 €	612 €
140	L4ESB1E500	622 €	622 €	622 €
150	L4ESB1F600	631 €	631 €	631 €
160	L4ESB1G700	641 €	641 €	641 €
170	L4ESB1H800	650 €	650 €	650 €
180	L4ESB1J900	660 €	660 €	660 €

Altura 72 cm

Código	Elección de perfil		
	U	B	H
	Blanco mate Branco mate	Silver Abrillantado	Negro mate
L4ESB26000	473 €	473 €	473 €
L4ESB27000	487 €	487 €	487 €
L4ESB28000	545 €	545 €	545 €
L4ESB29000	585 €	585 €	585 €
L4ESB2A100	594 €	594 €	594 €
L4ESB2A600	604 €	604 €	604 €
L4ESB2B200	608 €	608 €	608 €
L4ESB2C300	622 €	622 €	622 €
L4ESB2D400	635 €	635 €	635 €
L4ESB2E500	676 €	676 €	676 €
L4ESB2F600	684 €	684 €	684 €
L4ESB2G700	702 €	702 €	702 €
L4ESB2H800	721 €	721 €	721 €
L4ESB2J900	742 €	742 €	742 €

Altura 84 cm

Código	Elección de perfil		
	U	B	H
	Blanco mate Branco mate	Silver Abrillantado	Negro mate
L4ESB36000	481 €	481 €	481 €
L4ESB37000	540 €	540 €	540 €
L4ESB38000	581 €	581 €	581 €
L4ESB39000	595 €	595 €	595 €
L4ESB3A100	604 €	604 €	604 €
L4ESB3A600	612 €	612 €	612 €
L4ESB3B200	618 €	618 €	618 €
L4ESB3C300	634 €	634 €	634 €
L4ESB3D400	675 €	675 €	675 €
L4ESB3E500	688 €	688 €	688 €
L4ESB3F600	701 €	701 €	701 €
L4ESB3G700	717 €	717 €	717 €
L4ESB3H800	735 €	735 €	735 €
L4ESB3J900	763 €	763 €	763 €

ACCESORIOS **FRAME**



ESPEJOS CON ESTANTE DE ALUMÍNIO DE 14 CM DE PROFUNDIDAD, LED INTEGRADO
ESPELHOS COM PRATELEIRA DE ALUMÍNIO DE 14 CM DE PROFUNDIDADE, LED INTEGRADO

Altura 52 cm

ancho	Código	Elección de perfil		
		U	B	H
		Blanco mate Branco mate	Silver Abrillantado	Negro mate
60	L4ESF16000	241 €	241 €	241 €
70	L4ESF17000	258 €	258 €	258 €
80	L4ESF18000	275 €	275 €	275 €
90	L4ESF19000	291 €	291 €	291 €
100	L4ESF1A100	307 €	307 €	307 €
105	L4ESF1A600	315 €	315 €	315 €
110	L4ESF1B200	324 €	324 €	324 €
120	L4ESF1C300	337 €	337 €	337 €
130	L4ESF1D400	358 €	358 €	358 €
140	L4ESF1E500	378 €	378 €	378 €
150	L4ESF1F600	393 €	393 €	393 €
160	L4ESF1G700	409 €	409 €	409 €
170	L4ESF1H800	423 €	423 €	423 €
180	L4ESF1J900	439 €	439 €	439 €

Altura 72 cm

Código	Elección de perfil		
	U	B	H
	Blanco mate Branco mate	Silver Abrillantado	Negro mate
L4ESF26000	279 €	279 €	279 €
L4ESF27000	302 €	302 €	302 €
L4ESF28000	324 €	324 €	324 €
L4ESF29000	346 €	346 €	346 €
L4ESF2A100	366 €	366 €	366 €
L4ESF2A600	378 €	378 €	378 €
L4ESF2B200	388 €	388 €	388 €
L4ESF2C300	408 €	408 €	408 €
L4ESF2D400	438 €	438 €	438 €
L4ESF2E500	470 €	470 €	470 €
L4ESF2F600	496 €	496 €	496 €
L4ESF2G700	522 €	522 €	522 €
L4ESF2H800	547 €	547 €	547 €
L4ESF2J900	573 €	573 €	573 €

Altura 84 cm

Código	Elección de perfil		
	U	B	H
	Blanco mate Branco mate	Silver Abrillantado	Negro mate
L4ESF36000	297 €	297 €	297 €
L4ESF37000	320 €	320 €	320 €
L4ESF38000	344 €	344 €	344 €
L4ESF39000	366 €	366 €	366 €
L4ESF3A100	387 €	387 €	387 €
L4ESF3A600	400 €	400 €	400 €
L4ESF3B200	412 €	412 €	412 €
L4ESF3C300	431 €	431 €	431 €
L4ESF3D400	457 €	457 €	457 €
L4ESF3E500	485 €	485 €	485 €
L4ESF3F600	506 €	506 €	506 €
L4ESF3G700	527 €	527 €	527 €
L4ESF3H800	550 €	550 €	550 €
L4ESF3J900	571 €	571 €	571 €



ESPEJOS CON ESTANTES DE ALUMINIO DE 14 CM DE PROFUNDIDAD, LED INTEGRADO EN EL ESTANTE SUPERIOR
ESPELHOS COM PRATELEIRAS DE ALUMÍNIO DE 14 CM DE PROFUNDIDADE, LED INTEGRADO NA PRATELEIRA SUPERIOR

Altura 52 cm

ancho	Código	Elección de perfil		
		U	B	H
		Blanco mate Branco mate	Silver Abrillantado	Negro mate
60	L4ES816000	422 €	422 €	422 €
70	L4ES817000	444 €	444 €	444 €
80	L4ES818000	466 €	466 €	466 €
90	L4ES819000	494 €	494 €	494 €
100	L4ES81A100	517 €	517 €	517 €
105	L4ES81A600	535 €	535 €	535 €
110	L4ES81B200	544 €	544 €	544 €
120	L4ES81C300	573 €	573 €	573 €
130	L4ES81D400	590 €	590 €	590 €
140	L4ES81E500	609 €	609 €	609 €
150	L4ES81F600	622 €	622 €	622 €
160	L4ES81G700	635 €	635 €	635 €
170	L4ES81H800	652 €	652 €	652 €
180	L4ES81J900	669 €	669 €	669 €

Altura 72 cm

Código	Elección de perfil		
	U	B	H
	Blanco mate Branco mate	Silver Abrillantado	Negro mate
L4ES826000	434 €	434 €	434 €
L4ES827000	465 €	465 €	465 €
L4ES828000	494 €	494 €	494 €
L4ES829000	524 €	524 €	524 €
L4ES82A100	544 €	544 €	544 €
L4ES82A600	572 €	572 €	572 €
L4ES82B200	590 €	590 €	590 €
L4ES82C300	620 €	620 €	620 €
L4ES82D400	649 €	649 €	649 €
L4ES82E500	680 €	680 €	680 €
L4ES82F600	692 €	692 €	692 €
L4ES82G700	709 €	709 €	709 €
L4ES82H800	732 €	732 €	732 €
L4ES82J900	755 €	755 €	755 €

Altura 84 cm

Código	Elección de perfil		
	U	B	H
	Blanco mate Branco mate	Silver Abrillantado	Negro mate
L4ES836000	440 €	440 €	440 €
L4ES837000	472 €	472 €	472 €
L4ES838000	502 €	502 €	502 €
L4ES839000	534 €	534 €	534 €
L4ES83A100	555 €	555 €	555 €
L4ES83A600	582 €	582 €	582 €
L4ES83B200	600 €	600 €	600 €
L4ES83C300	632 €	632 €	632 €
L4ES83D400	662 €	662 €	662 €
L4ES83E500	693 €	693 €	693 €
L4ES83F600	704 €	704 €	704 €
L4ES83G700	720 €	720 €	720 €
L4ES83H800	745 €	745 €	745 €
L4ES83J900	769 €	769 €	769 €

ACCESORIOS FRAME



ESPEJOS CON ESTANTE DE ALUMINIO DE 14 CM DE PROFUNDIDAD, LED INTEGRADO EN ESTANTE SUPERIOR Y ESTANTE INFERIOR AMPLIADO EN 60 CM CON TOALLERO

ESPELHOS COM PRATELEIRA DE ALUMÍNIO DE 14 CM DE PROFUNDIDADE, LED INTEGRADO NA PRATELEIRA SUPERIOR E NA PRATELEIRA INFERIOR PROLONGADO POR 60 CM COM TOALHEIRO

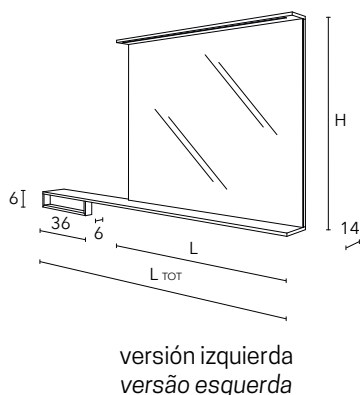
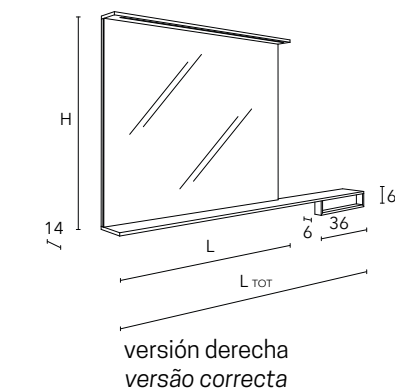

Medidas			Código	Derecha Direita	Izquierda Esquerda	Elección de perfil		
altura	Anchura total Largura Total	Ancho de espejo				U	B	H
						Blanco mate Branco mate	Silver Abrillantado	Negro mate
52	120	60	SPEC101	D	S	570 €	570 €	570 €
52	130	70	SPEC102	D	S	592 €	592 €	592 €
52	140	80	SPEC103	D	S	617 €	617 €	617 €
52	150	90	SPEC104	D	S	647 €	647 €	647 €
52	165	105	SPEC105	D	S	686 €	686 €	686 €
52	170	110	SPEC106	D	S	697 €	697 €	697 €
52	180	120	SPEC107	D	S	729 €	729 €	729 €
52	190	130	SPEC108	D	S	748 €	748 €	748 €
52	200	140	SPEC109	D	S	776 €	776 €	776 €
72	120	60	SPEC201	D	S	587 €	587 €	587 €
72	130	70	SPEC202	D	S	618 €	618 €	618 €
72	140	80	SPEC203	D	S	649 €	649 €	649 €
72	150	90	SPEC204	D	S	681 €	681 €	681 €
72	165	105	SPEC205	D	S	728 €	728 €	728 €
72	170	110	SPEC206	D	S	750 €	750 €	750 €
72	180	120	SPEC207	D	S	781 €	781 €	781 €
72	190	130	SPEC208	D	S	805 €	805 €	805 €
72	200	140	SPEC209	D	S	829 €	829 €	829 €
84	120	60	SPEC301	D	S	596 €	596 €	596 €
84	130	70	SPEC302	D	S	626 €	626 €	626 €
84	140	80	SPEC303	D	S	659 €	659 €	659 €
84	150	90	SPEC304	D	S	689 €	689 €	689 €
84	165	105	SPEC305	D	S	737 €	737 €	737 €
84	170	110	SPEC306	D	S	759 €	759 €	759 €
84	180	120	SPEC307	D	S	792 €	792 €	792 €
84	190	130	SPEC308	D	S	825 €	825 €	825 €
84	200	140	SPEC309	D	S	856 €	856 €	856 €



PANELES DE 12 CM DE PROFUNDIDAD CON ELEMENTOS DE ALUMINIO
PAINÉIS DE 12 CM DE PROFUNDIDADE COM ELEMENTOS DE ALUMÍNIO

Medidas				Código	Selección de color Seleção de cores de acabados									Elección de perfil		
versión versão	ancho	altura	Profundidad		A	U	I	N	M	X	R	O	S	U	B	H
					Blanco brillo Branco brilho	Blanco mate	Blanco rayado Branco listrado	Burlington	Grain	Dolomite	Ceniza	Polvo	Tortora	Blanco mate	Silver Abrillatado	Negro

DOS ESTANTES

derecha direita	60	24	12	D4EV97E5	380 €	380 €	380 €	380 €	380 €	380 €	412 €	412 €	412 €			
izquierda esquerda	60	24	12	S4EV97E5	380 €	380 €	380 €	380 €	380 €	380 €	412 €	412 €	412 €			

UN ESTANTE, UN TOALLERO

derecha direita	60	24	12	D4EV98E5	408 €	408 €	408 €	408 €	408 €	408 €	439 €	439 €	439 €			
izquierda esquerda	60	24	12	S4EV98E5	408 €	408 €	408 €	408 €	408 €	408 €	439 €	439 €	439 €			

UN ESTANTE, TOALLERO CROMADO

derecha direita	60	24	12	D4EV99E5	369 €	369 €	369 €	369 €	369 €	369 €	402 €	402 €	402 €			
izquierda esquerda	60	24	12	S4EV99E5	369 €	369 €	369 €	369 €	369 €	369 €	402 €	402 €	402 €			

DOS ESTANTES

derecha direita	60	24	12	D4EV9AE5	412 €	412 €	412 €	412 €	412 €	412 €	444 €	444 €	444 €			
izquierda esquerda	60	24	12	S4EV9AE5	412 €	412 €	412 €	412 €	412 €	412 €	444 €	444 €	444 €			

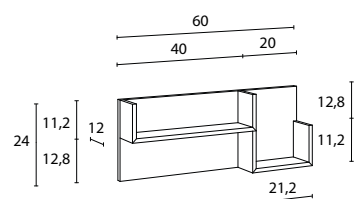
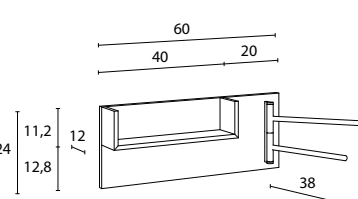
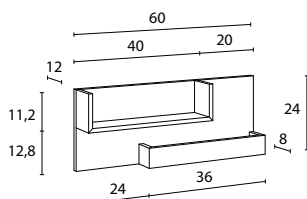
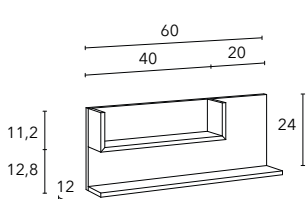

ACCESORIOS
ACCESÓRIOS

ACCESORIOS FRAME



PANELES DE 12 CM DE PROFUNDIDAD CON ELEMENTOS DE ALUMINIO APAINELAMENTO DE 12 CM DE PROFUNDIDADE COM ELEMENTOS DE ALUMÍNIO

Medidas			Código	Selección de color / Seleção de cores de acabados										Selección de perfil		
versión / versão	ancho	altura Profundidad		A	U	I	N	M	X	R	O	S	U	B	H	
				Blanco brillo Branco brilho	Blanco mate	Blanco rayado Branco listrado	Burlington	Grain	Dolomite	Ceniza	Polvo	Tortora	Blanco mate	Silver Abrillan- tado	Negro	

UN ESTANTE															
derecha / direita	100	24	12	D4EV91A1	381 €	381 €	381 €	381 €	381 €	381 €	426 €	426 €	426 €		
izquierda / esquerda				S4EV91A1	381 €	381 €	381 €	381 €	381 €	381 €	426 €	426 €	426 €		
derecha / direita	120	24	12	D4EV91C3	405 €	405 €	405 €	405 €	405 €	405 €	461 €	461 €	461 €		
izquierda / esquerda				S4EV91C3	405 €	405 €	405 €	405 €	405 €	405 €	461 €	461 €	461 €		
derecha / direita	140	24	12	D4EV91E5	426 €	426 €	426 €	426 €	426 €	426 €	491 €	491 €	491 €		
izquierda / esquerda				S4EV91E5	426 €	426 €	426 €	426 €	426 €	426 €	491 €	491 €	491 €		

UN ESTANTE, DOS ORIFICIOS DE Ø 6 CM PARA VASOS															
derecha / direita	100	24	12	D4EV93A1	391 €	391 €	391 €	391 €	391 €	391 €	436 €	436 €	436 €		
izquierda / esquerda				S4EV93A1	391 €	391 €	391 €	391 €	391 €	391 €	436 €	436 €	436 €		
derecha / direita	120	24	12	D4EV93C3	413 €	413 €	413 €	413 €	413 €	413 €	468 €	468 €	468 €		
izquierda / esquerda				S4EV93C3	413 €	413 €	413 €	413 €	413 €	413 €	468 €	468 €	468 €		
derecha / direita	140	24	12	D4EV93E5	436 €	436 €	436 €	436 €	436 €	436 €	501 €	501 €	501 €		
izquierda / esquerda				S4EV93E5	436 €	436 €	436 €	436 €	436 €	436 €	501 €	501 €	501 €		

UN ESTANTE, TOALLERO															
derecha / direita	100	24	12	D4EV96A1	465 €	465 €	465 €	465 €	465 €	465 €	509 €	509 €	509 €		
izquierda / esquerda				S4EV96A1	465 €	465 €	465 €	465 €	465 €	465 €	509 €	509 €	509 €		
derecha / direita	120	24	12	D4EV96C3	487 €	487 €	487 €	487 €	487 €	487 €	542 €	542 €	542 €		
izquierda / esquerda				S4EV96C3	487 €	487 €	487 €	487 €	487 €	487 €	542 €	542 €	542 €		
derecha / direita	140	24	12	D4EV96E5	509 €	509 €	509 €	509 €	509 €	509 €	575 €	575 €	575 €		
izquierda / esquerda				S4EV96E5	509 €	509 €	509 €	509 €	509 €	509 €	575 €	575 €	575 €		

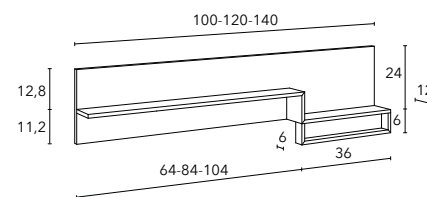
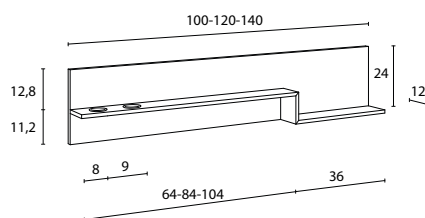
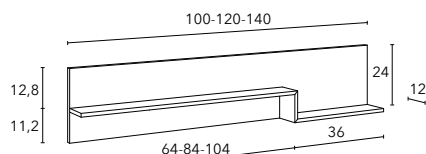



PANELES DE 12 CM DE PROFUNDIDAD CON ELEMENTOS DE ALUMINIO
APAINELAMENTO DE 12 CM DE PROFUNDIDADE COM ELEMENTOS DE ALUMÍNIO

Medidas			Código	Selección de color / Seleção de cores de acabados										Selección de perfil		
versión / versão	ancho	altura Profundidad		A	U	I	N	M	X	R	O	S	U	B	H	
				Blanco brillo Branco brilho	Blanco mate	Blanco rayado Branco listrado	Burlington	Grain	Dolomite	Ceniza	Polvo	Tortora	Bianco Morbido	Silver Abrillan- tado	Negro	

UNA BALDA, DOS HUECOS PORTAVASOS DE Ø 6 CM, TOALLERO

derecha / direita	100	24	12	D4EV92A1	474 €	474 €	474 €	474 €	474 €	474 €	521 €	521 €	521 €			
izquierda / esquerda				S4EV92A1	474 €	474 €	474 €	474 €	474 €	474 €	521 €	521 €	521 €			
derecha / direita	120	24	12	D4EV92C3	501 €	501 €	501 €	501 €	501 €	501 €	555 €	555 €	555 €			
izquierda / esquerda				S4EV92C3	501 €	501 €	501 €	501 €	501 €	501 €	555 €	555 €	555 €			
derecha / direita	140	24	12	D4EV92E5	521 €	521 €	521 €	521 €	521 €	521 €	585 €	585 €	585 €			
izquierda / esquerda				S4EV92E5	521 €	521 €	521 €	521 €	521 €	521 €	585 €	585 €	585 €			

UN ESTANTE, UN ORIFICIO DE Ø 8 CM PARA UN SOPORTE DE SECADOR DE PELO

derecha / direita	100	24	12	D4EV95A1	385 €	385 €	385 €	385 €	385 €	385 €	431 €	431 €	431 €			
izquierda / esquerda				S4EV95A1	385 €	385 €	385 €	385 €	385 €	385 €	431 €	431 €	431 €			
derecha / direita	120	24	12	D4EV95C3	408 €	408 €	408 €	408 €	408 €	408 €	464 €	464 €	464 €			
izquierda / esquerda				S4EV95C3	408 €	408 €	408 €	408 €	408 €	408 €	464 €	464 €	464 €			
derecha / direita	140	24	12	D4EV95E5	431 €	431 €	431 €	431 €	431 €	431 €	496 €	496 €	496 €			
izquierda / esquerda				S4EV95E5	431 €	431 €	431 €	431 €	431 €	431 €	496 €	496 €	496 €			

UN ESTANTE, DOS ORIFICIOS DE Ø 6 CM PARA VASOS, TOALLERO, UN ORIFICIO DE Ø 8 CM PARA SECADOR DE PELO

derecha / direita	100	24	12	D4EV94A1	396 €	396 €	396 €	396 €	396 €	396 €	440 €	440 €	440 €			
izquierda / esquerda				S4EV94A1	396 €	396 €	396 €	396 €	396 €	396 €	440 €	440 €	440 €			
derecha / direita	120	24	12	D4EV94C3	418 €	418 €	418 €	418 €	418 €	418 €	473 €	473 €	473 €			
izquierda / esquerda				S4EV94C3	418 €	418 €	418 €	418 €	418 €	418 €	473 €	473 €	473 €			
derecha / direita	140	24	12	D4EV94E5	440 €	440 €	440 €	440 €	440 €	440 €	506 €	506 €	506 €			
izquierda / esquerda				S4EV94E5	440 €	440 €	440 €	440 €	440 €	440 €	506 €	506 €	506 €			

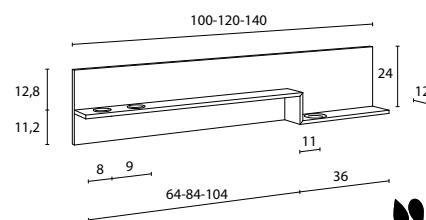
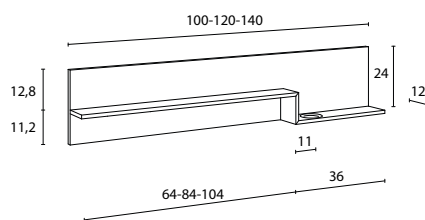
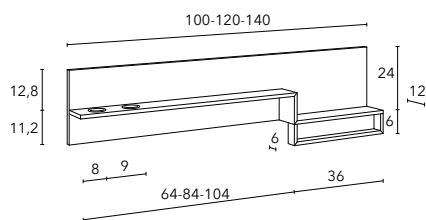



GRIFERÍA MONOMANDO PARA LAVABO
MISTURADORA MONOCOMANDO PARA LAVATORIO
 versión cuerpo alto
 versão alta

tomas para grifería	Código	Color Cores	Precio / Preço
1/2"	RUBDLAHH-K	Cromo	384 €
1/2"	RUBDLAHH-H	Negro	517 €

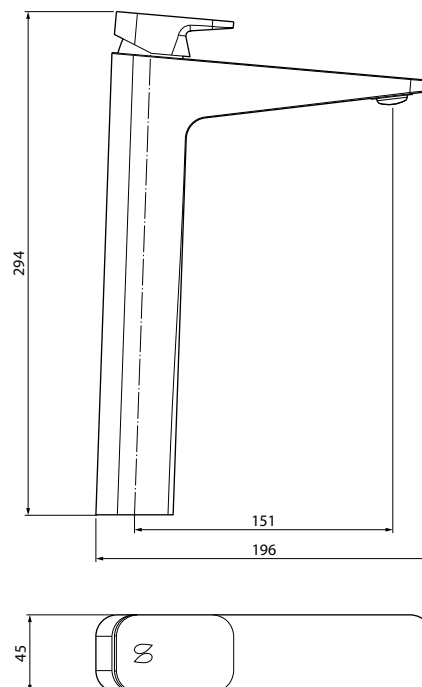

Válvula Clic-Clak incluida en el precio
 Valvula click-clack incluida no preço



**GRIFERÍA MONOMANDO PARA LAVABO
MISTURADORA MONOCOMANDO PARA LAVATORIO**
versión cuerpo bajo
versão baixa

tomas para grifería	Código	Color Cores	Precio / Preço
1/2"	RUBDLAHL-K	Cromo	322 €
1/2"	RUBDLAHL-H	Negro	438 €

Válvula standard incluida en el precio
Valvula standard incluida no preço

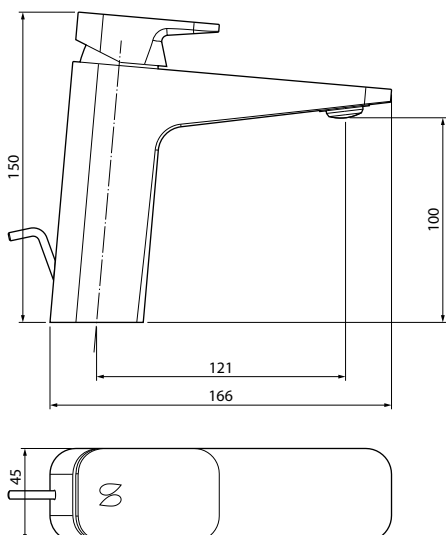

**GRIFERÍA MONOMANDO PARA BIDET
MISTURADORA MONOCOMANDO PARA BIDE**

tomas para grifería	Código	Color Cores	Precio / Preço
1/2"	RUBDBI-K	Cromo	322 €
1/2"	RUBDBI-H	Negro	438 €

Válvula standard incluida en el precio
Valvula standard incluida no preço

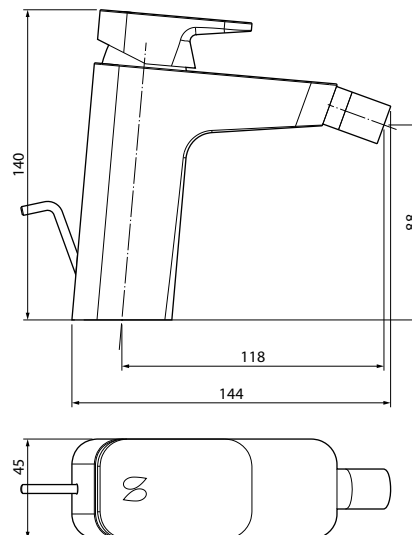

GRIFERÍA / TORNEIRA SERIE FLY 3



GRIFERÍA MONOMANDO PARA BAÑERA
 con desviador de 2 funciones: llenado de bañera o ducha de mano
MISTURADORA MONOCOMANDO PARA BANHEIRA
 com derivador 2 funções

tomas para grifería	Código	Color Cores	Precio / Preço
1/2"	RUBBVSFY3-K	Cromo	438 €
1/2"	RUBBVSFY3-28	Negro mate	596 €

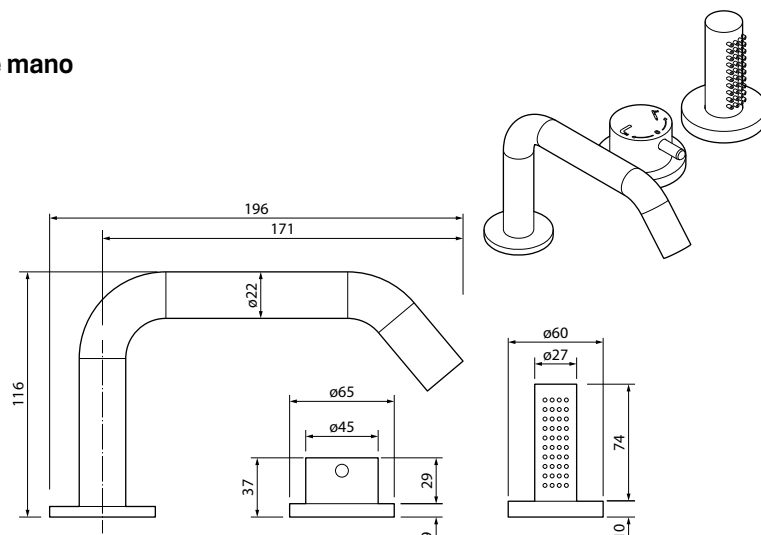

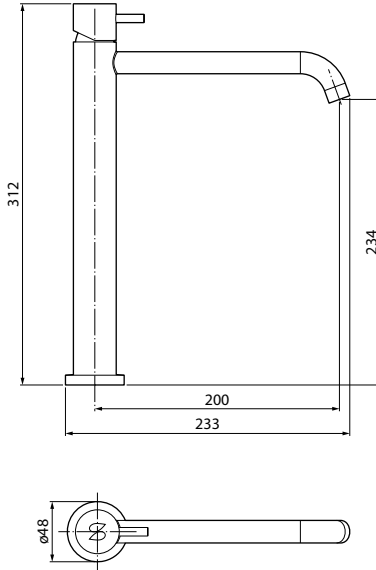

**GRIFERÍA MONOMANDO PARA LAVABO
MISTURADORA MONOCOMANDO PARA LAVATORIO
versión cuerpo alto
versão alta**

tomas para grifería	Código	Color Cores	Precio / Preço
1/2"	RUBLAHHFY3-K	Cromo	307 €
1/2"	RUBLAHHFY3-28	Negro mate	418 €



Válvula Clic-Clak incluida en el precio
Valvula click-clack incluida no preço

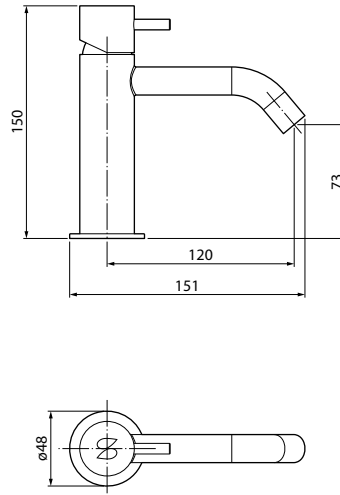

**GRIFERÍA MONOMANDO PARA LAVABO
MISTURADORA MONOCOMANDO PARA LAVATORIO
versión cuerpo bajo
versão baixa**

tomas para grifería	Código	Color Cores	Precio / Preço
1/2"	RUBLAHHFY3-K	Cromo	307 €
1/2"	RUBLAHHFY3-28	Negro mate	418 €



Válvula Clic-Clak incluida en el precio
Valvula click-clack incluida no preço

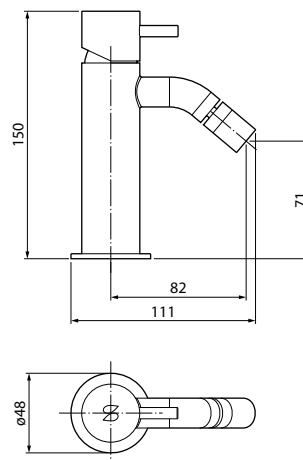

**GRIFERÍA MONOMANDO PARA BIDET
MISTURADORA MONOCOMANDO PARA BIDE**

tomas para grifería	Código	Color Cores	Precio / Preço
1/2"	RUBBIFY3-K	Cromo	253 €
1/2"	RUBBIFY3-28	Negro mate	342 €



Válvula Clic-Clak incluida en el precio
Valvula click-clack incluida no preço

GRIFERÍA / TORNEIRA SERIE FLY 2

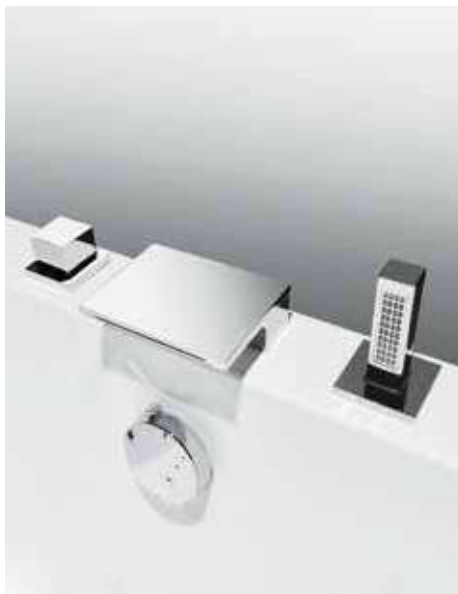

GRIFERÍA PARA BORDE DE BAÑERA
 con mezclador progresivo con 2 funciones: cascada o ducha de mano
MISTURADORA PARA REBORDO DA BANHEIRA
 com misturadora progresiva com 2 funções: cascata ou chuveiro de mão

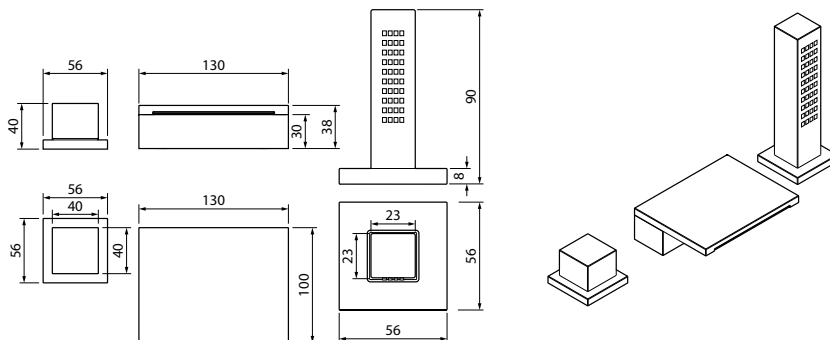

tomas para grifería	Código	Color/Cores	Precio / Preço
1/2"	KRUBBVAQNO-K	Cromo	629 €

versión cuerpo alto
 versão alta



versión cuerpo bajo
 versão baixa

GRIFERÍA MONOMANDO PARA LAVABO
MISTURADORA MONOCOMANDO PARA LAVATORIO

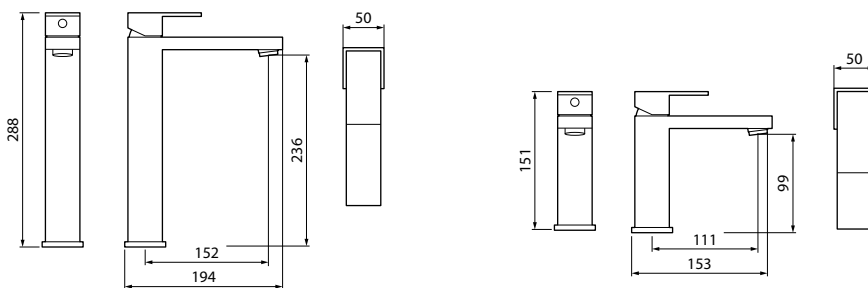

Medidas	tomas para grifería	Código	Color/Cores	Precio / Preço
versión alta versao alta				
H 28,8 x 19,4 cm	1/2"	RUBLA288NO-K	Cromo	431 €
versión baja versao baixa				
H 15,5 x 15,3 cm	1/2"	RUBLA151NO-K	Cromo	370 €



Válvula Clic-Clak incluida en el precio
 Valvula click-clack incluida no preço



GRIFERÍA MONOMANDO PARA BIDET
MISTURADORA MONOCOMANDO PARA BIDE

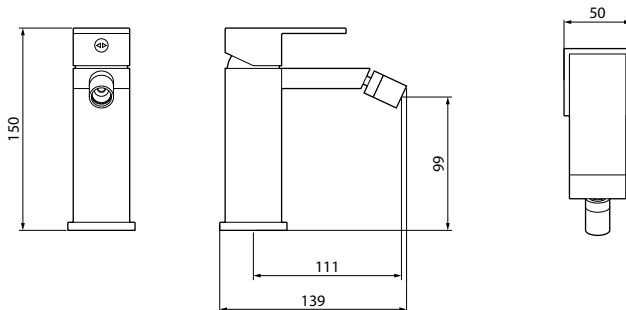

Medidas	tomas para grifería	Código	Color/Cores	Precio / Preço
H 15 x 13,9 cm	1/2"	RUBBI151NO-K	Cromo	342 €



Válvula Clic-Clak incluida en el precio
 Valvula click-clack incluida no preço

GRIFERÍA / TORNEIRA PARA BAÑERAS / PARA BANHEIRAS

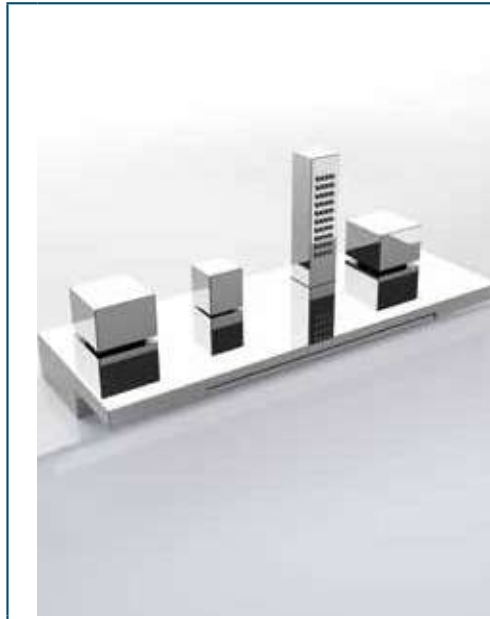

GRIFERÍA PARA BORDE DE BAÑERA (para Sense Dual, Sense 3, Sense 4)
 con desviador de dos funciones: llenado de bañera o ducha de mano
MISTURADORA PARA REBORDO DA BANHEIRA (para Sense Dual, Sense 3, Sense 4)
 com derivador 2 funções

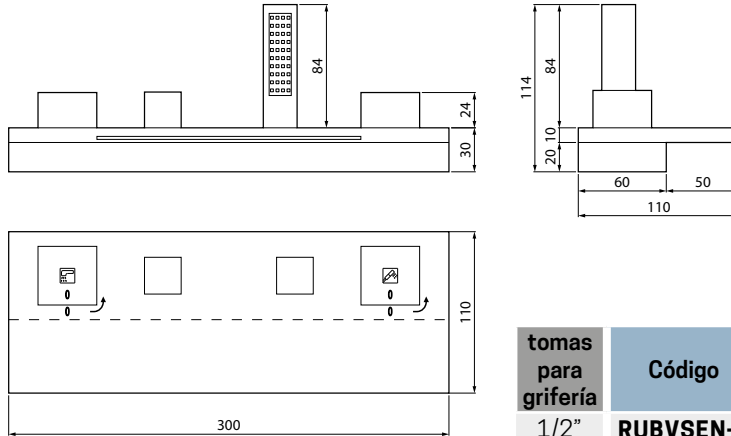

tomas para grifería	Código	Color Cores	Precio / Preço
1/2"	RUBVSEN-K	Cromo	1.092 €



SIFÓN



tomas para grifería	Código	Color Cores	Precio / Preço
1/4"	SIFRUBLAV-K	Cromo	117 €
1/4"	SIFRUBLAV-28	Negro mate	193 €

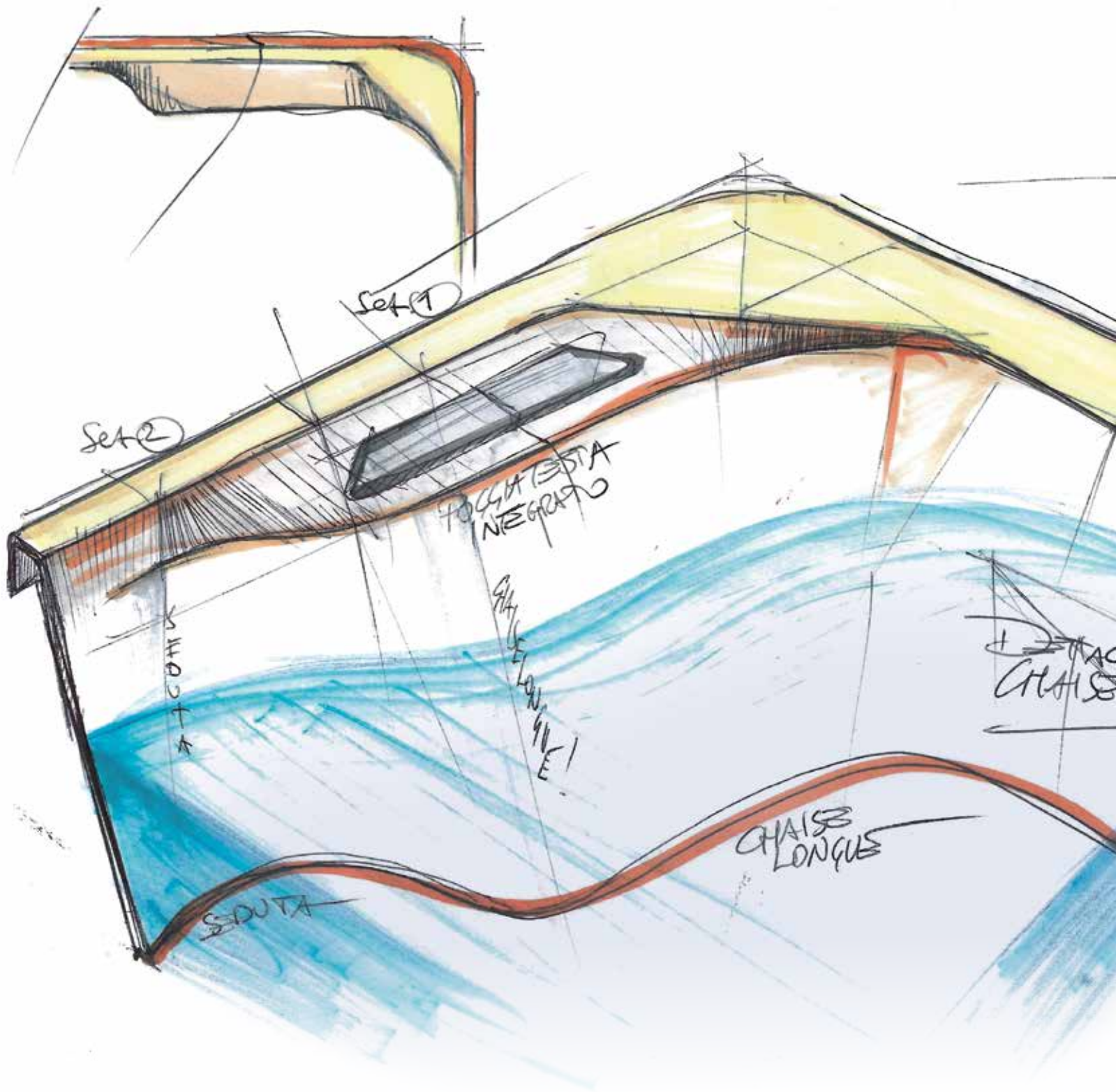

- 616 Moon
- 623 Divina M SPA
- 627 Divina L SPA
- 631 Divina XL SPA
- 639 Divina XXL SPA
- 635 Vita XL
- 639 Vita XXL
- 643 Complementos SPA

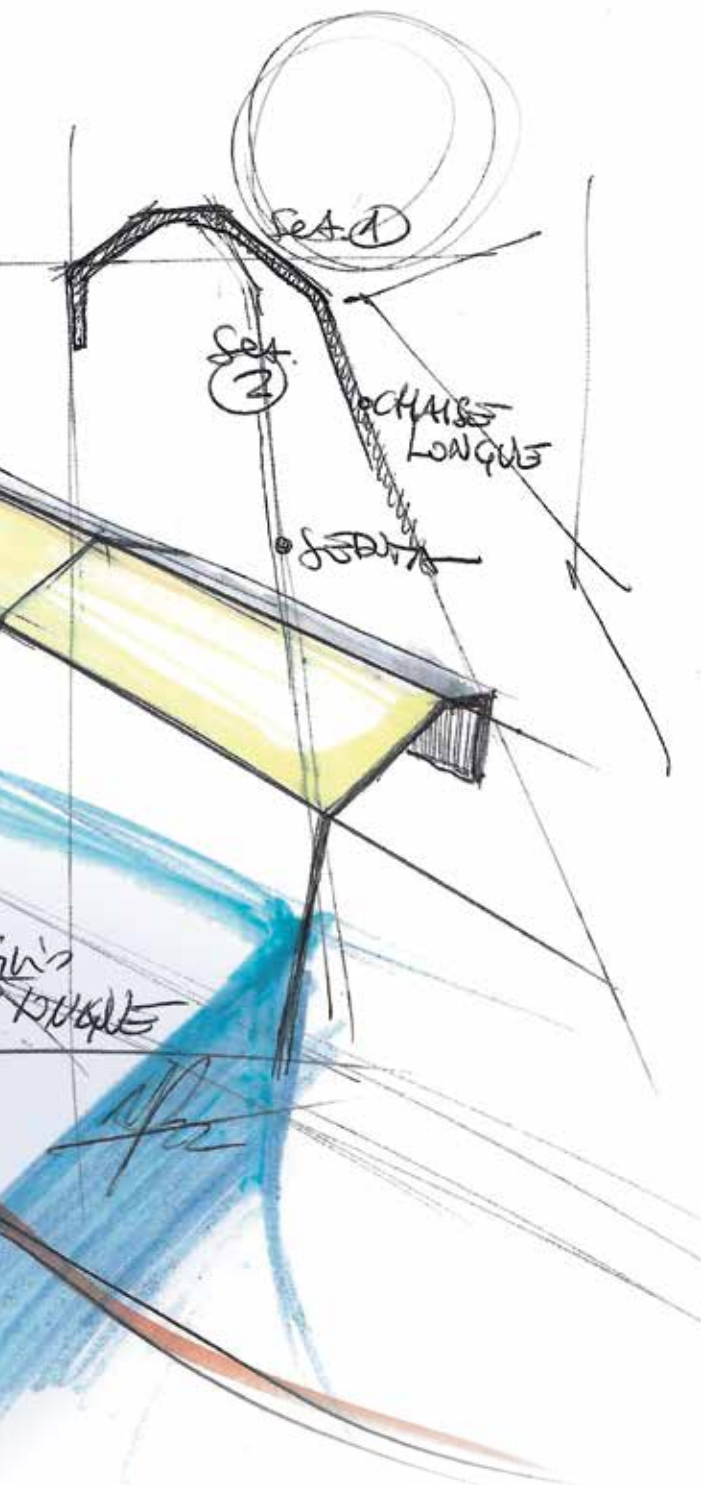

OUTDOOR SPA

UN NUEVO ESPACIO PARA DESCUBRIR Y DISEÑAR TU BIENESTAR.

OUTDOOR SPA es la línea de productos wellness para exterior que interpreta a la perfección el concepto de disfrutar por completo de todo el espacio del hogar. Ya sea un lounge en una terraza o en un ambiente exclusivo de relax, a cielo abierto, cerca de la habitación o en la zona de descanso de una vivienda, OUTDOOR SPA sabrá dar forma al espacio con una estética y unos acabados que se combinan a la perfección en un ambiente único, contemporáneo, sin límites y con un carácter decidido. Las Minipiscinas SPA están equipadas con exclusivos sistemas de hidromasaje Whirlpool para un bienestar completo, con iluminación blanca o Cromolight, sistema audio Bluetooth y toda una serie de accesorios que completan el confort de tu espacio OUTDOOR. OUTDOOR DIVINA SPA será el refugio perfecto para tu cuerpo y tus sentidos, para disfrutar y compartir con quien tú quieras.

UM NOVO ESPAÇO A DESCOBRIR E REDESENHAR PARA O SEU BEM-ESTAR.

OUTDOOR SPA é a linha de produtos para o bem-estar exterior que interpreta perfeitamente o novo conceito de viver "em todo o lado". Seja num salão no terraço ou numa área de relaxamento ao ar livre junto ao quarto, OUTDOOR SPA dará forma aos seus espaços com estética e cores que se misturam num ambiente contemporâneo único, sem fronteiras e com um carácter forte. Os banhos SPA estão equipados com sistemas específicos de hidromassagem Whirlpool para o bem-estar total, iluminação branca ou Cromolight, áudio Bluetooth e uma série de acessórios que completam o conforto do seu espaço OUTDOOR DIVINA SPA, o refúgio para os seus sentidos e o seu corpo desfrutarem juntamente com quem quiserem.



MOON | ACABADOS PANELES

COLOR DE LA MINI-PISCINA / CORES DA MINIPISCINA

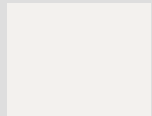

Blanco
Branco

PANELES ARCILLA - PAINÉIS ARGILA

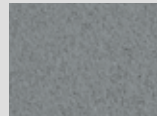

Ceniza

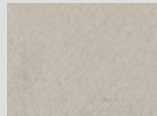

Polvo

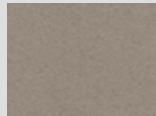

Tórtola

ASIENTO Y REPOSACABEZAS - APOIA-CABEÇAS



Light grey



Warm brown



Steel

PANELES TACTO NATURAL "NATURAL TOUCH" PAINÉIS NATURAL TOUCH



Oak Alpine



Oak Concrete

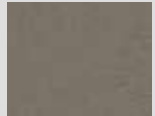

Oxid

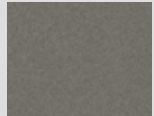

Quarz

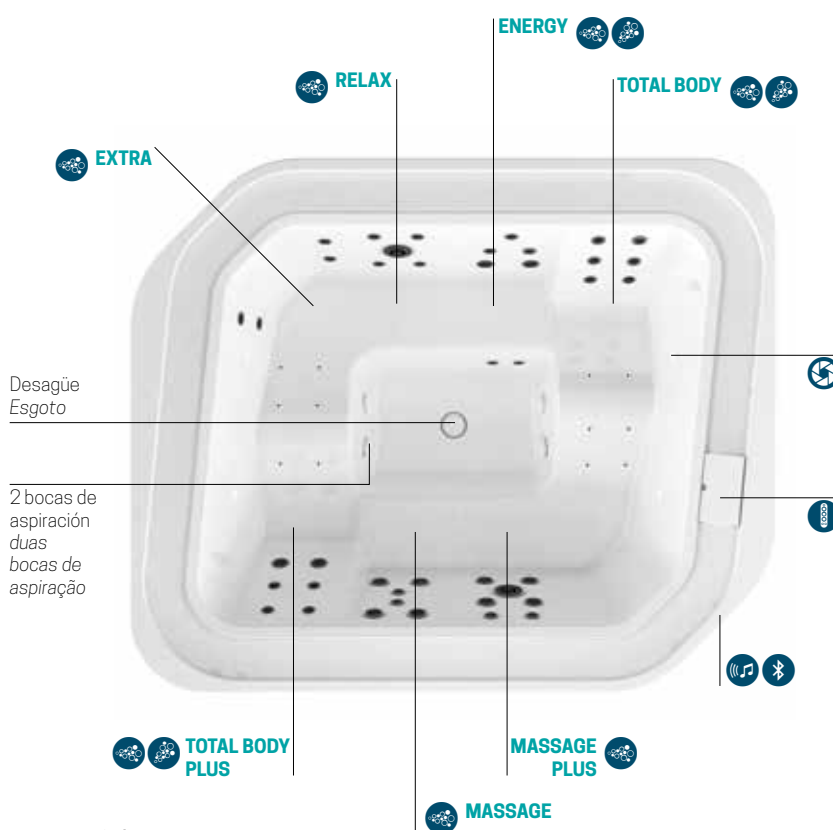

Masaje corporal Whirlpool aire/agua con regulación de tiempo e intensidad manual o automática para satisfacer cualquier necesidad de bienestar.

Massagem corpo Whirlpool ar/agua com regulação de tempo e intensidade manual ou automática.



Sistema de purificación **AQUACLEAN** (UV+ozono)
Sistema de purificação **AQUACLEAN** (UV+ozono)



4 Cromolight con 8 variaciones de color para activar la mente y excitar el espíritu.

4 Cromolight com 8 variações de cor para activar a mente e excitar o espírito.



Panel de control
Painel de controle



Altavoces de audio Bluetooth
4 internos y 4 externos

Altifalantes áudio Bluetooth
4 internos e 4 externos



Design by Simone Micheli



Panel de control
Panel de controle

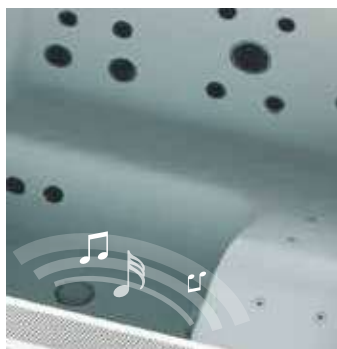

Sistema cromolight & audio



Rejilla rebosadero
Grelha de transbordo



Filtro de arena
Filtro de areia



MOON

MOON

MINIPISCINA MULTIFUNCIÓN / MINIPISCINA MULTIFUNCIONAL

Dimensiones cm
Dimensões em cm. 215 x 260 H 93

Asientos
Lugares 6+1

Capacidad litros
Capacidade litros 1550

Código	Selección de funciones / Precio Escolha de funções / Preço				Color del asiento y reposacabezas Cores dos bancos e dos apoios de cabeça
	Standard + Luces LED blancas	Aquaclean + Luces LED blancas	UV + Cromolight + audio Bluetooth	Aquaclean + Cromolight + audio Bluetooth	

Blanco
Branco





PLUS					
	0X1	8X1	6X1	9X1	-W10K
MOON40					

INTERCAMBIADOR DE CALOR / INTERCAMBIADOR DE CALOR					
	0R1	8R1	6R1	9R1	-W10K
MOON40					

Construcción del código: **Código** + **Selección de funciones** + **Color del asiento y reposacabezas** = código producto final
 Construção do código: **Código** + **Escolha de funções** + **Cores dos bancos e dos apoios de cabeça** = código final do produto

PANELES / PAINÉIS

Código	Selección de paneles Seleção de painéis			
--------	--	--	--	--

PANELES TACTO NATURAL "NATURAL TOUCH" / PAINÉIS NATURAL TOUCH				
	P1	P2	P3	P4
				
	Oak-Alpine	Oak-Concrete	Oxid	Quarz
PANV2F2LM00-				

















PANELES ARCILLA / PAINÉIS ARGILA			
	R	O	S
			
	Ceniza	Polvo	Tórtola
PANV2F2LM00-			

PANELES DE FIBRA TRENZADA / PAINÉIS FIBER-CROSS			
	T1	T2	T3
			
	Light Grey	Warm Brown	Steel
PATV2F2LM00-			



FUNCIONES / FUNCIONALIDADES

PLUS

	Whirlpool jets	41
	Whirlpool mini jets	12
	Sistema de purificación Aquaclean (UV + ozono) <i>Aquaclean purification system (UV+ozone)</i>	OPTIONAL
	Sistema de purificación UV <i>UV purification system</i>	●
	4 luces led blancas <i>4 Branco LED light</i>	●
	4 Chromolight	OPTIONAL
	Sistema audio stereo + bluetooth <i>Integrated audio system + Bluetooth</i>	OPTIONAL
	Módulo Wi-Fi <i>Modulo Wi-Fi</i>	OPTIONAL
	2 Bombas de una velocidad <i>2 Bombas de velocidade única</i>	●
	Bomba de recirculación <i>Bomba de recirculação</i>	●
	Calentador de 3 KW <i>Aquecedor 3W</i>	●
	Intercambiador de calor <i>Intercambiador de calor</i>	OPTIONAL
	Llenado automático <i>Preenchimento automático</i>	●
	Depósito de compensación <i>Tanque de compensação</i>	●
	Vaciado rápido <i>Esvaziamento rápido</i>	●
	Filtro de arena <i>Filtro de areia</i>	●
	Botón de accionamiento <i>Chave de transmissão directa</i>	OPTIONAL

MÓDULO WI-FI / MODULO WI-FI

Código

Precio / Preço

DOMOWF

KIT AISLAMIENTO FONDO MINIPISCINA / KIT DE ISOLAMENTO DO FUNDO DO TANQUE

Código

Precio / Preço

MOTHCOFV

KIT OPCIONAL PARA CLIMAS EXTREMOS / KIT OPCIONAL PARA CLIMAS FRIOS

aislamiento
isolamento

Código

Precio / Preço

OPTIONAL Kit aislamiento paneles
OPTIONAL Kit de isolamento do painel

KBT2F2LM00

COBERTURA TÉRMICA / TAMPA TÉRMICA

aislamiento
isolamento

Código

Precio / Preço

C1

C2

Plenty Grey

Brown

Cobertura térmica estival
Cobertura de verão

MOTHCO-

Cobertura térmica invernal
Capa de inverno

MOTHCOT-

VERSIONE **PLUS**

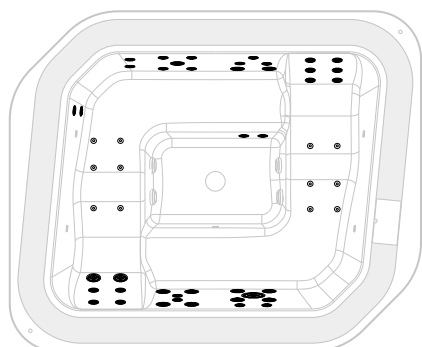



DIVINA M SPA | ACABADOS PANELES

COLOR DE LA MINIPISCINA / CORES DA MINIPISCINA

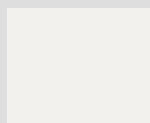

Blanco
Branco

PANELES ALISTONADOS / PAINÉIS ACABAMENTO MADEIRA

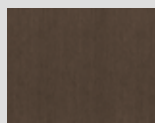

Dark brown

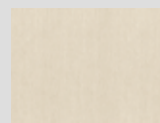

Ice

PANELES TACTO NATURAL "NATURAL TOUCH" / PAINÉIS NATURAL TOUCH



Oak Alpine



Oak Concrete

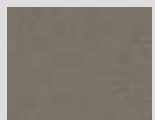

Oxid

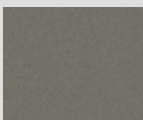

Quarz

ASIENTO Y REPOSACABEZAS - APOIA-CABEÇAS

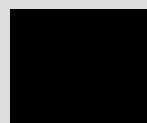

Negro



Light grey



Warm brown

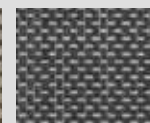

Steel

Fiber-Cross

PANELES FIBER-CROSS / PAINÉIS FIBER-CROSS



Light grey



Warm brown

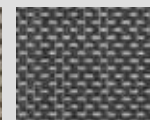

Steel

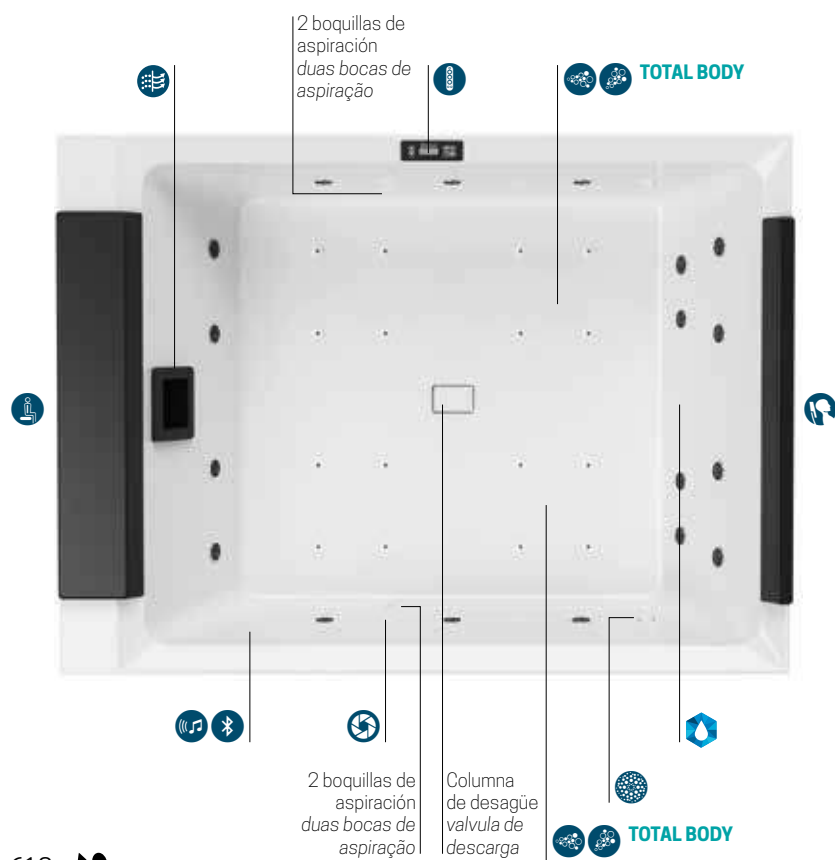

Masaje Airpool mediante jets de aire con regulación manual on/off o programa secuencial, para una **estimulación celular eficaz**.



Massagem Airpool através de jets de ar com regulação manual on/off ou programa sequencial, para uma **estimulação celular eficaz**.



Masaje corporal Whirlpool aire/agua con regulación de tiempo e intensidad manual o automática para satisfacer cualquier necesidad de bienestar.



Massagem corpo Whirlpool ar/agua com regulação de tempo e intensidade manual ou automática.



Filtro desnatador de agua
Escumadeira de filtro de água



Aquaclean UV+Ozono



2 Natural air



4 Cromolight con 8 variaciones de color para activar la mente y excitar el espíritu.



4 Cromolight com 8 variações de cor para activar a mente e excitar o espírito.



Panel de control



Painel de controle

Reposacabezas
Apoia-cabeças



Asiento con control de desagüe



Assento com controlo de drenagem



Altavoces de audio Bluetooth
4 internos y 4 externos



Altifalantes áudio Bluetooth
4 internos e 4 externos



Panel de control
Panel de controle

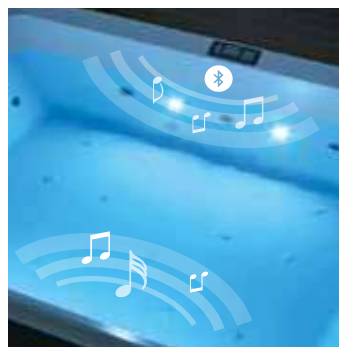

Sistema cromolight & audio



Natural Air



Aquaclean, el nuevo sistema de
Desinfección y mantenimiento
del agua
*Aquaclean, o novo sistema de
purificação e manutenção da agua*



DIVINA M SPA

DIVINA M SPA

MINIPISCINA MULTIFUNCIÓN / MINIPISCINA MULTIFUNCIONAL

Dimensiones cm
Dimensões em cm. 190 x 140 H 75









Asientos
Lugares 2

Capacidad litros
Capacidade litros 550

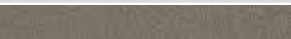
Código	Selección de funciones / Precio Escolha de funções / Preço						Llenado automático Preenchimento automático		Colores de la Minipiscina Cores da Minipiscina	Color del asiento y reposacabezas Cores dos bancos e dos apoios de cabeça			
	Standard + Luces LED blancas	UV + Luces LED blancas	Aquaclean + Luces LED blancas	Cromolight + audio Bluetooth	UV + Cromolight + Bluetooth	Aquaclean + Cromolight + audio Bluetooth	SIN SEM	CON COM		Bianco Lucido	Nero	Light Grey	Warm Brown
STANDARD													
	0X	3X	8X	6X	4X	9X	0	1	-A0	H	T1	T2	T3
DOM50													
STANDARD INTERCAMBIADOR DE CALOR													
	0R	3R	8R	6R	4R	9R	0	1	-A0	H	T1	T2	T3
DOM50													
PLUS													
	0X	3X	8X	6X	4X	9X	0	1	-A0	H	T1	T2	T3
DOM40													
PLUS CON INTERCAMBIADOR DE CALOR													
	0R	3R	8R	6R	4R	9R	0	1	-A0	H	T1	T2	T3
DOM40													
PLUS+NATURAL AIR													
	0X	3X	8X	6X	4X	9X	0	1	-A0	H	T1	T2	T3
DOMPO													
PLUS+NATURAL AIR CON INTERCAMBIADOR DE CALOR													
	0R	3R	8R	6R	4R	9R	0	1	-A0	H	T1	T2	T3
DOMPO													

Construcción del código: **Código** + **Selección de funciones** + **Colores de la Minipiscina** + **Color del asiento y reposacabezas** = código producto final
 Construção do código: **Código** + **Escolha de funções** + **Cores da Minipiscina** + **Cores dos bancos e dos apoios de cabeça** = código final do produto

PANELES / PAINÉIS

Código	Selección de paneles Seleção de paineis			
PANELES TACTO NATURAL "NATURAL TOUCH" / PAINÉIS NATURAL TOUCH				
	P1	P2	P3	P4
				
	Oak-Alpine	Oak-Concrete	Oxid	Quarz
PANV2F2LDIVDO-				
PANELES ALISTONADOS / PAINÉIS ACABAMENTO MADEIRA				
	D1	D2		
				
	Dark Brown	Ice		
PADV2F2LDIVDO-				
PANELES DE FIBRA TRENZADA / PAINÉIS FIBER-CROSS				
	T1	T2	T3	
				
	Light Grey	Warm Brown	Steel	
PATV2F2LDIVDO-				

FUNCIONES / FUNCIONALIDADES	STANDARD	PLUS	PLUS+NATURAL AIR
Whirlpool jets	18	18	18
Whirlpool mini jets	-	16	16
Natural Air	-	-	2
Sistema de purificación Aquaclean (UV + ozono) <i>Aquaclean purification system (UV+ozone)</i>	OPTIONAL	OPTIONAL	OPTIONAL
Sistema de purificación UV <i>UV purification system</i>	OPTIONAL	OPTIONAL	OPTIONAL
4 luces led blancas <i>4 Branco LED light</i>	●	●	●
4 Chromolight	OPTIONAL	OPTIONAL	OPTIONAL
Reposacabezas <i>Apoio de cabeça</i>	OPTIONAL	OPTIONAL	OPTIONAL
Sistema audio stereo + bluetooth <i>Integrated audio system + Bluetooth</i>	OPTIONAL	OPTIONAL	OPTIONAL
Módulo Wi-Fi <i>Modulo Wi-Fi</i>	OPTIONAL	OPTIONAL	OPTIONAL
2 Bombas de una velocidad <i>2 Bombas de velocidade única</i>	●	●	●
Skimmer para filtrado del agua <i>Skimmer water filter</i>	●	●	●
Calentador de 2 KW <i>Aquecedor 2 W</i>	●	●	●
Intercambiador de calor <i>Intercambiador de calor</i>	OPTIONAL	OPTIONAL	OPTIONAL
Llenado automático <i>Preenchimento automático</i>	OPTIONAL	OPTIONAL	OPTIONAL

MÓDULO WI-FI / MODULO WI-FI

Código	Precio / Preço
DOMOWF	

KIT AISLAMIENTO FONDO MINIPISCINA / KIT DE ISOLAMENTO DO FUNDO DO TANQUE

Código	Precio / Preço
DOTHCOFV	

KIT OPCIONAL PARA CLIMAS EXTREMOS / KIT OPCIONAL PARA CLIMAS FRIOS

aislamiento <i>isolamento</i>	Código	Precio / Preço
OPTIONAL Kit aislamiento paneles OPTIONAL <i>Kit de isolamento do painel</i>	KBT2F2LDOM	

COBERTURA TÉRMICA / TAMPA TÉRMICA

aislamiento <i>isolamento</i>	Código	Precio / Preço	
		C1	C2
		Plenty Grey	Brown
Cobertura térmica estival <i>Cobertura de verão</i>	MOTHCO-		
Cobertura térmica invernal <i>Capa de inverno</i>	MOTHCOT-		

VERSIONE STANDARD

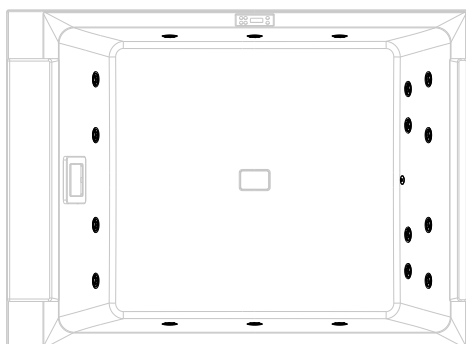

VERSIONE PLUS

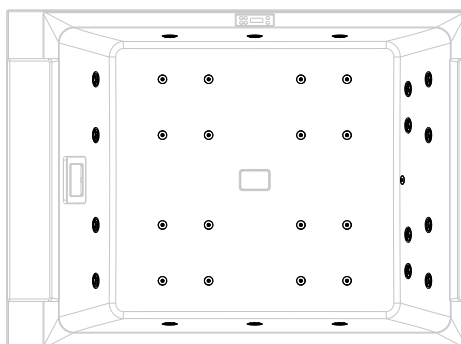

VERSIONE PLUS+NATURAL AIR

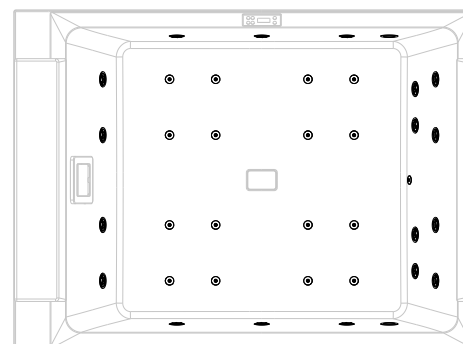



DIVINA L SPA | ACABADOS PANELES

COLOR DE LA MINIPISCINA / CORES DA MINIPISCINA

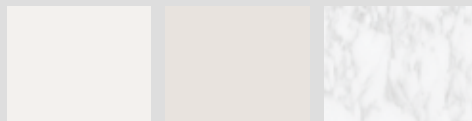

Blanco
Branco

Perla

Marmo chiaro

PANELES TACTO NATURAL "NATURAL TOUCH" PAINÉIS NATURAL TOUCH



Oak Alpine

Oak Concrete

Oxid

Quarz

PANELES ALISTONADOS PAINÉIS ACABAMENTO MADEIRA

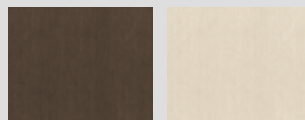

Dark brown

Ice

PANELES FIBER-CROSS PAINÉIS FIBER-CROSS



Light grey

Warm brown

Steel

ASIENTO Y REPOSACABEZAS - APOIA-CABEÇAS

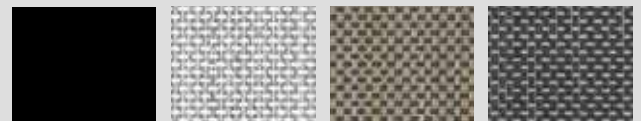

Negro

Light grey

Warm brown

Steel

Fiber-Cross

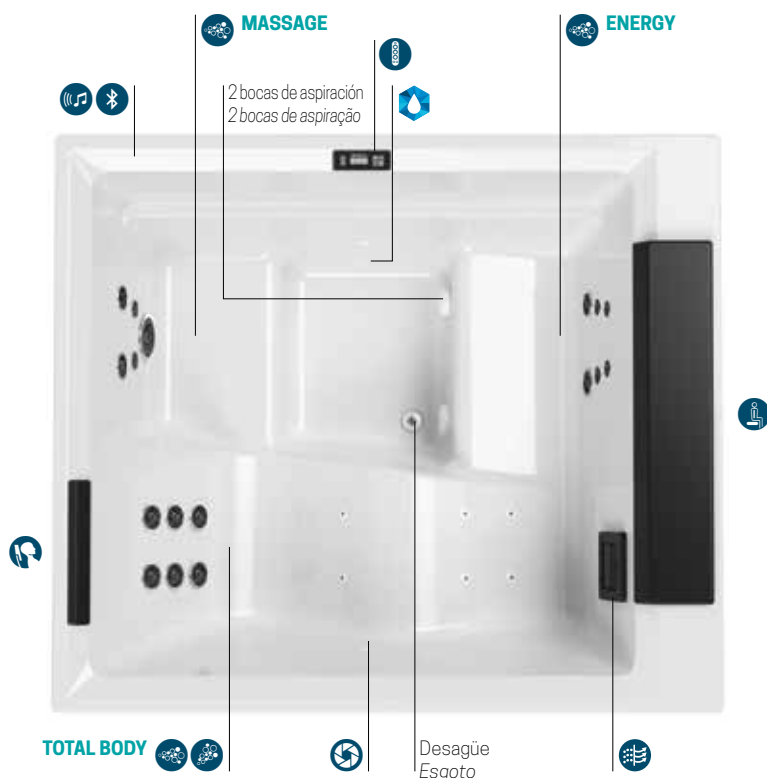

Masaje Airpool mediante jets de aire con regulación manual on/off o programa secuencial, para una **estimulación celular eficaz**.



Massagem Airpool através de jets de ar com regulação manual on/off ou programa sequencial, para uma **estimulação celular eficaz**.



Masaje corporal Whirlpool aire/agua con regulación de tiempo e intensidad manual o automática para satisfacer cualquier necesidad de bienestar.



Massagem corpo Whirlpool ar/agua com regulação de tempo e intensidade manual ou automática.



Filtro desnatador de agua
Escumadeira de filtro de água



Aquaclean UV+Ozono



4 Cromolight con 8 variaciones de color para activar la mente y excitar el espíritu.



4 Cromolight com 8 variações de cor para activar a mente e excitar o espírito.



Panel de control
Painel de controle



Reposacabezas
Apoia-cabeças



Asiento con control de desagüe
Assento com controlo de drenagem



Altavoces de audio Bluetooth
2 internos y 2 externos



Altifalantes áudio Bluetooth
2 internos e 2 externos



Panel de control
Panel de controle

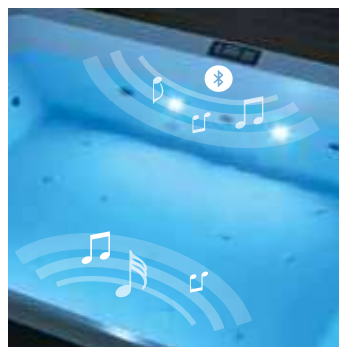

Sistema cromolight & audio



Aquaclean, el nuevo sistema de
Desinfección y mantenimiento
del agua
*Aquaclean, o novo sistema de
purificação e manutenção da água*



Jet de hidromasaje de alta
eficacia
Jacto de massagem de alta
eficiência



DIVINA L SPA

DIVINA L SPA

MINIPISCINA MULTIFUNCIÓN / MINIPISCINA MULTIFUNZIONAL

Dimensiones cm Dimensões em cm.	185 x 160 H 85
Asientos Lugares	3
Capacidad litros Capacidade litros	680













Código	Selección de funciones / Precio Escolha de funções / Preço						Llenado automático Preenchimento automático		Colores de la Minipiscina Cores da Minipiscina			Color del asiento y reposacabezas Cores dos bancos e dos apoios de cabeça			
	Standard + Luces LED blancas	UV + Luces LED blancas	Aquaclean + Luces LED blancas	Cromolight + audio Bluetooth	UV + Cromolight + Bluetooth	Aquaclean + Cromolight + audio Bluetooth	SIN SEM	CON COM							
								Blanco Branco	Perla	Marmo chiaro	Negro	Light Grey	Warm Brown	Steel	

STANDARD															
	0X	3X	8X	6X	4X	9X	0	1	-W10	-W20	-W30	H	T1	T2	T3
DOL50															
STANDARD INTERCAMBIADOR DE CALOR															
	0R	3R	8R	6R	4R	9R	0	1	-W10	-W20	-W30	H	T1	T2	T3
DOL50															
PLUS															
	0X	3X	8X	6X	4X	9X	0	1	-W10	-W20	-W30	H	T1	T2	T3
DOL40															
PLUS CON INTERCAMBIADOR DE CALOR															
	0R	3R	8R	6R	4R	9R	0	1	-W10	-W20	-W30	H	T1	T2	T3
DOL40															

Construcción del código: **Código** + **Selección de funciones** + **Colores de la Minipiscina** + **Color del asiento y reposacabezas** = código producto final
 Construção do código: **Código** + **Escolha de funções** + **Cores da Minipiscina** + **Cores dos bancos e dos apoios de cabeça** = código final do produto

PANELES / PAINÉIS

Código	Selección de paneles Seleção de painéis			
PANELES TACTO NATURAL "NATURAL TOUCH" / PAINÉIS NATURAL TOUCH				
	P1	P2	P3	P4
PANV2F2LDIVDL-	Oak-Alpine	Oak-Concrete	Oxid	Quarz
PANELES ALISTONADOS / PAINÉIS ACABAMENTO MADEIRA				
	D1	D2		
PADV2F2LDIVDL-	Dark Brown	Ice		
PANELES DE FIBRA TRENZADA / PAINÉIS FIBER-CROSS				
	T1	T2	T3	
PATV2F2LDIVDL-	Light Grey	Warm Brown	Steel	

FUNCIONES / FUNCIONALIDADES		STANDARD	PLUS
	Whirlpool mini jets	4	6
	Whirlpool jets	12	18
	2 Luces led blancas 2 Branco LED light	●	●
	2 Chromolight	OPTIONAL	OPTIONAL
	Reposacabezas Apoio de cabeça	-	●
	Sistema audio stereo + bluetooth Integrated audio system + Bluetooth	OPTIONAL	OPTIONAL
	Módulo Wi-Fi Modulo Wi-Fi	OPTIONAL	OPTIONAL
	Sistema de purificación Aquaclean (UV + ozono) Aquaclean purification system (UV+ozone)	OPTIONAL	OPTIONAL
	Sistema de purificación UV UV purification system	OPTIONAL	OPTIONAL
	Bomba de doble velocidad Double speed pump	●	●
	Calentador 2 KW Heater 2 kW	●	●
	Intercambiador de calor Intercambiador de calor	OPTIONAL	OPTIONAL
	Llenado automático Preenchimento automático	OPTIONAL	OPTIONAL

MÓDULO WI-FI / MODULO WI-FI	
Código	Precio / Preço
DOMOWF	

KIT AISLAMIENTO FONDO MINIPISCINA / KIT DE ISOLAMENTO DO FUNDO DO TANQUE	
Código	Precio / Preço
DLTHCOFV	

KIT OPCIONAL PARA CLIMAS EXTREMOS / KIT OPCIONAL PARA CLIMAS FRIOS		
aislamiento isolamento	Código	Precio / Preço
OPTIONAL Kit aislamiento paneles OPTIONAL Kit de isolamento do painel	KBT2F2LDOL	

COBERTURA TÉRMICA / TAMPA TÉRMICA			
aislamiento isolamento	Código	Precio / Preço	
		C1	C2
		Plenty Grey	Brown
Cobertura térmica estival Cobertura de verão	DLTHCO-		
Cobertura térmica invernal Capa de inverno	DLTHCOT-		

VERSIONE STANDARD

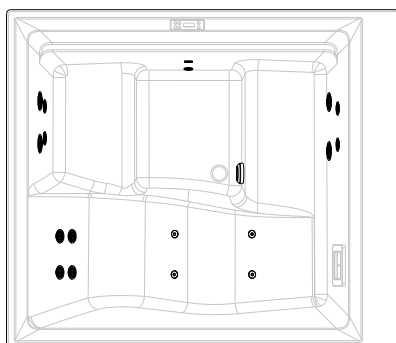

VERSIONE PLUS

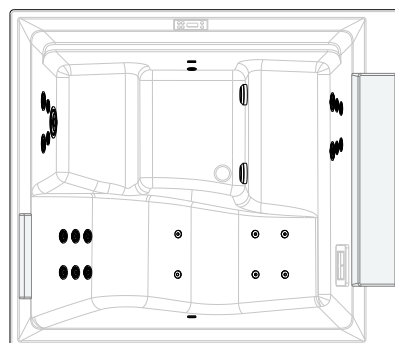



DIVINA XL SPA | ACABADOS PANELES

COLOR DE LA MINIPISCINA / CORES DA MINIPISCINA

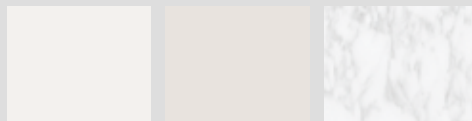

Blanco
Branco

Perla

Marmo chiaro

PANELES TACTO NATURAL "NATURAL TOUCH" PAINÉIS NATURAL TOUCH



Oak Alpine

Oak Concrete

Oxid

Quarz

PANELES ALISTONADOS PAINÉIS ACABAMENTO MADEIRA

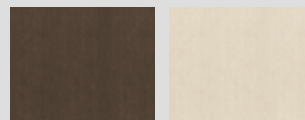

Dark brown

Ice

PANELES FIBER-CROSS PAINÉIS FIBER-CROSS



Light grey

Warm brown

Steel

ASIENTO Y REPOSACABEZAS - APOIA-CABEÇAS

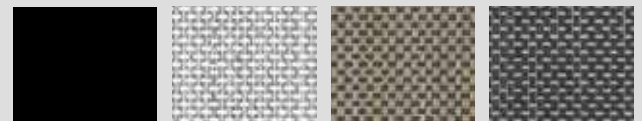

Negro

Light grey

Warm brown

Steel

Fiber-Cross

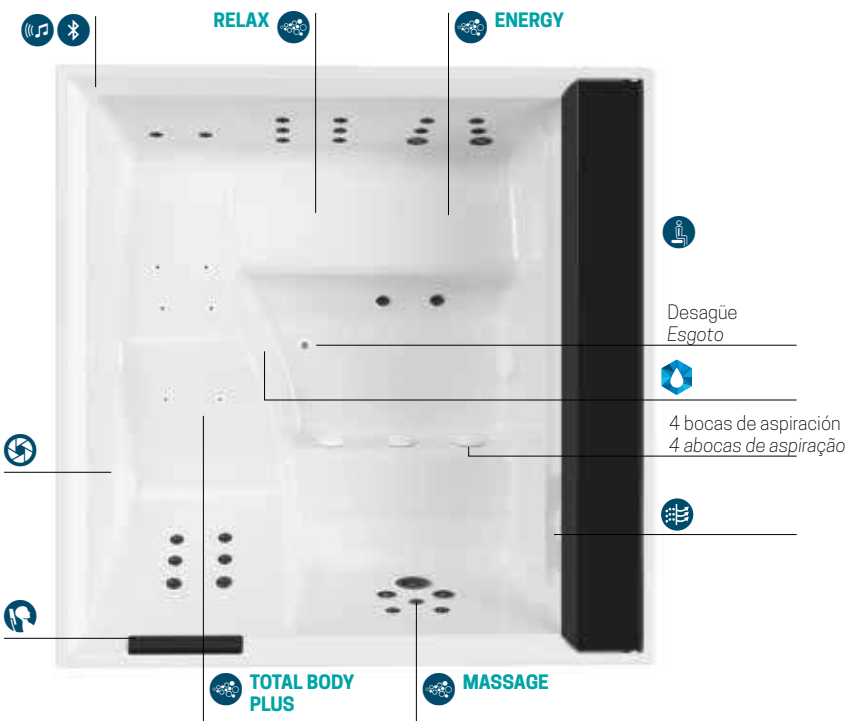

Masaje Airpool mediante jets de aire con regulación manual on/off o programa secuencial, para una **estimulación celular eficaz**.



Massagem Airpool através de jets de ar com regulação manual on/off ou programa sequencial, para uma **estimulação celular eficaz**.



Masaje corporal Whirlpool aire/agua con regulación de tiempo e intensidad manual o automática para satisfacer cualquier necesidad de bienestar.



Massagem corpo Whirlpool ar/agua com regulação de tempo e intensidade manual ou automática.



Filtro desnatador de agua
Escumadeira de filtro de água



Aquaclean UV+Ozono



4 Cromolight con 8 variaciones de color para activar la mente y excitar el espíritu.



4 Cromolight com 8 variações de cor para activar a mente e excitar o espírito.



Panel de control
Painel de controle



Reposacabezas
Apoia-cabeças



Asiento con control de desagüe
Assento com controlo de drenagem



Altavoces de audio Bluetooth
4 internos y 4 externos



Altifalantes áudio Bluetooth
4 internos e 4 externos



Panel de control
Panel de controle

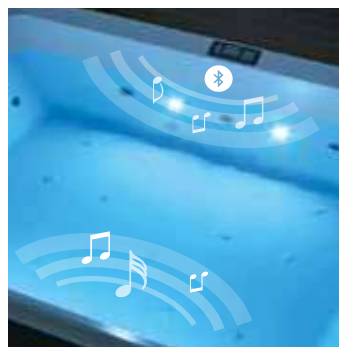

Sistema cromolight & audio



Aquaclean, el nuevo sistema de
Desinfección y mantenimiento
del agua
*Aquaclean, o novo sistema de
purificação e manutenção da água*



Asiento de acceso, con
mecanismo de cierre soft-
closing
*Assento de acesso à banheira,
com mecanismo de fecho lento*



DIVINA XL SPA

DIVINA XL SPA

MINIPISCINA MULTIFUNCIÓN / MINIPISCINA MULTIFUNCIONAL

Dimensiones cm
Dimensões em cm. 200 x 200 H 85

Asientos
Lugares 4















Capacidad litros
Capacidade litros 930

Código	Selección de funciones / Precio Escolha de funções / Preço				Llenado automático Preenchimento automático		Colores de la Minipiscina Cores da Minipiscina			Color del asiento y reposacabezas Cores dos bancos e dos apoios de cabeça			
	Standard + Luces LED blancas	Aquaclean + Luces LED blancas	Cromolight + audio Bluetooth	Aquaclean + Cromolight + audio Bluetooth	SIN SEM	CON COM							
							Blanco Branco	Perla	Marmo claro	Negro	Light Grey	Warm Brown	Steel
STANDARD													
	0X	8X	6X	9X	0	1	-W10	-W20	-W30	H	T1	T2	T3
DOXL50													
STANDARD INTERCAMBIADOR DE CALOR													
	0R	8R	6R	9R	0	1	-W10	-W20	-W30	H	T1	T2	T3
DOXL50													
PLUS													
	0X	8X	6X	9X	0	1	-W10	-W20	-W30	H	T1	T2	T3
DOXL40													
PLUS CON INTERCAMBIADOR DE CALOR													
	0R	8R	6R	9R	0	1	-W10	-W20	-W30	H	T1	T2	T3
DOXL40													

Construcción del código: Código + Selección de funciones + Colores de la Minipiscina + Color del asiento y reposacabezas = código producto final
 Construção do código: Código + Escolha de funções + Cores da Minipiscina + Cores dos bancos e dos apoios de cabeça = código final do produto

PANELES / PAINÉIS

Código	Selección de paneles Seleção de paineis			
PANELES TACTO NATURAL "NATURAL TOUCH" / PAINÉIS NATURAL TOUCH				
	P1	P2	P3	P4
	Oak-Alpine	Oak-Concrete	Oxid	Quarz
PANV2F2LDIVDX-				
PANELES ALISTONADOS / PAINÉIS ACABAMENTO MADEIRA				
	D1	D2		
	Dark Brown	Ice		
PADV2F2LDIVDX-				
PANELES DE FIBRA TRENZADA / PAINÉIS FIBER-CROSS				
	T1	T2	T3	
	Light Grey	Warm Brown	Steel	
PATV2F2LDIVDX-				

FUNCIONES / FUNCIONALIDADES		STANDARD	PLUS
	whirlpool mini jets	4	6
	whirlpool jets	18	28
	4 Luces led blancas 4 Branco LED light	●	●
	4 Chromolight	OPTIONAL	OPTIONAL
	Reposacabezas Apoio de cabeça	-	●
	Sistema audio stereo + bluetooth Integrated audio system + Bluetooth	OPTIONAL	OPTIONAL
	Módulo Wi-Fi Modulo Wi-Fi	OPTIONAL	OPTIONAL
	Sistema de purificación Aquaclean (UV + ozono) Aquaclean purification system (UV+ozone)	OPTIONAL	OPTIONAL
	Sistema de purificación UV UV purification system	●	●
	Bomba de velocidad única Single speed pump	-	●
	Bomba de doble velocidad Double speed pump	●	●
	Calentador 3 KW Heater 3 kW	●	●
	Intercambiador de calor Intercambiador de calor	OPTIONAL	OPTIONAL
	Llenado automático Preenchimento automático	OPTIONAL	OPTIONAL

MÓDULO WI-FI / MODULO WI-FI	
Código	Precio / Preço
DOMWF	

KIT AISLAMIENTO FONDO MINIPISCINA / KIT DE ISOLAMENTO DO FUNDO DO TANQUE	
Código	Precio / Preço
DXTHCOFV	

KIT OPCIONAL PARA CLIMAS EXTREMOS / KIT OPCIONAL PARA CLIMAS FRIOS		
aislamiento isolamento	Código	Precio / Preço
OPTIONAL Kit aislamiento paneles OPTIONAL Kit de isolamento do painel	KBT2F2LDOXL	

COBERTURA TÉRMICA / TAMPA TÉRMICA			
aislamiento isolamento	Código	Precio / Preço	
		C1	C2
		Plenty Grey	Brown
Cobertura térmica estival Cobertura de verão	DXTHCO-		
Cobertura térmica invernal Capa de inverno	DXTHCOT-		

VERSIONE STANDARD

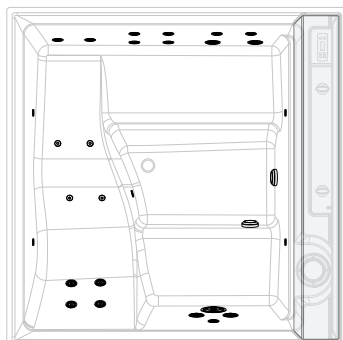

VERSIONE PLUS

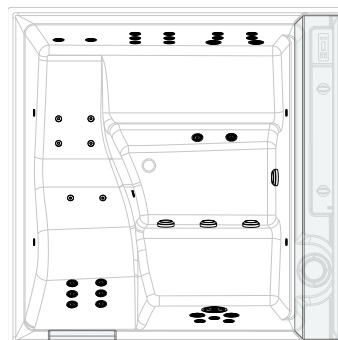



DIVINA XXL SPA | ACABADOS PANELES

COLOR DE LA MINIPISCINA / CORES DA MINIPISCINA

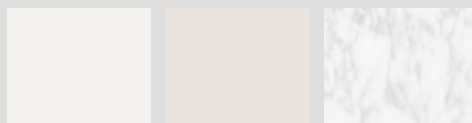

Blanco
Branco

Perla

Marmo chiaro

PANELES TACTO NATURAL "NATURAL TOUCH" PAINÉIS NATURAL TOUCH



Oak Alpine

Oak Concrete

Oxid

Quarz

PANELES ALISTONADOS PAINÉIS ACABAMENTO MADEIRA

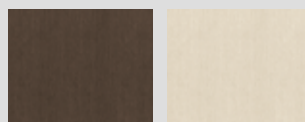

Dark brown

Ice

PANELES FIBER-CROSS PAINÉIS FIBER-CROSS



Light grey

Warm brown

Steel

ASIENTO Y REPOSACABEZAS - APOIA-CABEÇAS

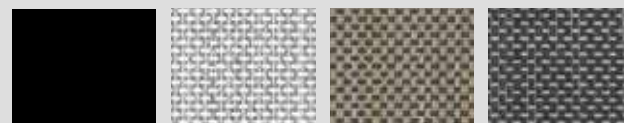

Negro

Light grey

Warm brown

Steel

Fiber-Cross

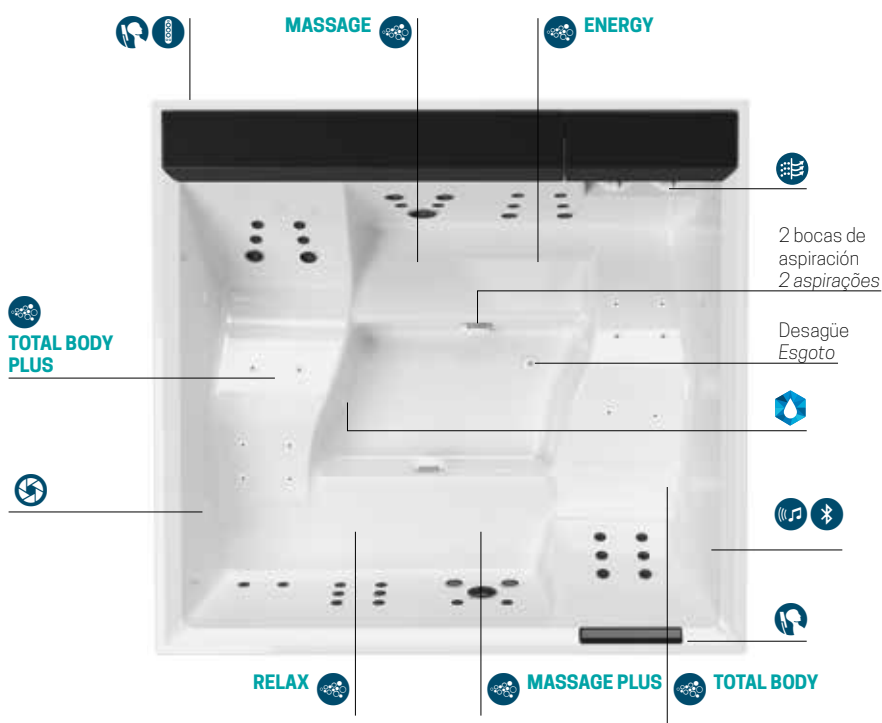

Masaje Airpool mediante jets de aire con regulación manual on/off o programa secuencial, para una **estimulación celular eficaz**.



Massagem Airpool através de jets de ar com regulação manual on/off ou programa sequencial, para uma **estimulação celular eficaz**.



Masaje corporal Whirlpool aire/agua con regulación de tiempo e intensidad manual o automática para satisfacer cualquier necesidad de bienestar.

Massagem corpo Whirlpool ar/agua com regulação de tempo e intensidade manual ou automática.

Filtro desnatador de agua
Escumadeira de filtro de água



Aquaclean UV+Ozono



4 Cromolight con 8 variaciones de color para activar la mente y excitar el espíritu.

4 Cromolight com 8 variações de cor para activar a mente e excitar o espírito.



Panel de control
Painel de controle



Reposacabezas
Apoia-cabeças



Asiento con control de desagüe
Assento com controlo de drenagem



Altavoces de audio Bluetooth
4 internos y 4 externos
Altifalantes áudio Bluetooth
4 internos e 4 externos



Panel de control
Panel de controle

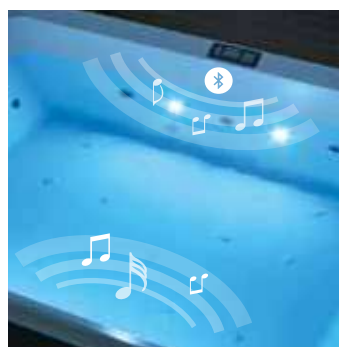

Sistema cromolight & audio



Aquaclean, el nuevo sistema de
Desinfección y mantenimiento
del agua
*Aquaclean, o novo sistema de
purificação e manutenção da água*

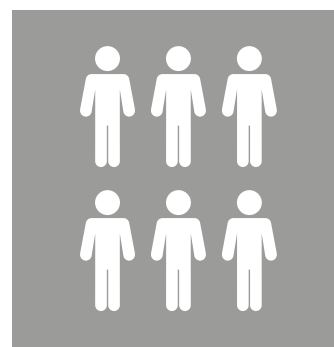

Minipiscina para 6



DIVINA XXL SPA

DIVINA XXL SPA

MINIPISCINA MULTIFUNCIÓN / MINIPISCINA MULTIFUNCIONAL

Dimensiones cm / Dimensões em cm. 230 x 215 H 85

Asientos Lugares 6

Capacidad litros / Capacidade litros 1160

Código	Selección de funciones / Precio Escolha de funções / Preço				Llenado automático Preenchimento automático		Colores de la Minipiscina Cores da Minipiscina			Color del asiento y reposacabezas Cores dos bancos e dos apoios de cabeça			
	Standard + Luces LED blancas	Aquaclean + Luces LED blancas	Cromolight + audio Bluetooth	Aquaclean + Cromolight + audio Bluetooth	SIN SEM	CON COM							
STANDARD													
	0X	8X	6X	9X	0	1	-W10	-W20	-W30	H	T1	T2	T3
DOXXL50													
STANDARD INTERCAMBIADOR DE CALOR													
	0R	8R	6R	9R	0	1	-W10	-W20	-W30	H	T1	T2	T3
DOXXL50													
PLUS													
	0X	8X	6X	9X	0	1	-W10	-W20	-W30	H	T1	T2	T3
DOXXL40													
PLUS CON INTERCAMBIADOR DE CALOR													
	0R	8R	6R	9R	0	1	-W10	-W20	-W30	H	T1	T2	T3
DOXXL40													

Construcción del código: **Código** + **Selección de funciones** + **Colores de la Minipiscina** + **Color del asiento y reposacabezas** = código producto final
 Construção do código: **Código** + **Escolha de funções** + **Cores da Minipiscina** + **Cores dos bancos e dos apoios de cabeça** = código final do produto

PANELES / PAINÉIS

Código	Selección de paneles Seleção de painéis			
PANELES TACTO NATURAL "NATURAL TOUCH" / PAINÉIS NATURAL TOUCH				
	P1	P2	P3	P4
	Oak-Alpine	Oak-Concrete	Oxid	Quarz
PANV2F2LDIVDXX-				
PANELES ALISTONADOS / PAINÉIS ACABAMENTO MADEIRA				
	D1	D2		
	Dark Brown	Ice		
PADV2F2LDIVDXX-				
PANELES DE FIBRA TRENZADA / PAINÉIS FIBER-CROSS				
	T1	T2	T3	
	Light Grey	Warm Brown	Steel	
PATV2F2LDIVDXX-				

FUNCIONES / FUNCIONALIDADES		STANDARD	PLUS
	whirlpool mini jets	8	16
	whirlpool jets	24	36
	4 Luces led blancas 4 Branco LED light	●	●
	4 Chromolight	OPTIONAL	OPTIONAL
	Reposacabezas Apoio de cabeça	-	●
	Sistema audio stereo + bluetooth Integrated audio system + Bluetooth	OPTIONAL	OPTIONAL
	Módulo Wi-Fi Modulo Wi-Fi	OPTIONAL	OPTIONAL
	Sistema de purificación Aquaclean (UV + ozono) Aquaclean purification system (UV+ozone)	OPTIONAL	OPTIONAL
	Sistema de purificación UV UV purification system	●	●
	Bomba de velocidad única Single speed pump	-	●
	Bomba de doble velocidad Double speed pump	●	●
	Calentador 3 KW Heater 3 kW	●	●
	Intercambiador de calor Intercambiador de calor	OPTIONAL	OPTIONAL
	Llenado automático Preenchimento automático	OPTIONAL	OPTIONAL

MÓDULO WI-FI / MODULO WI-FI	
Código	Precio / Preço
DOMOWF	

KIT AISLAMIENTO FONDO MINIPISCINA / KIT DE ISOLAMENTO DO FUNDO DO TANQUE	
Código	Precio / Preço
DXXTHCOFV	

KIT OPCIONAL PARA CLIMAS EXTREMOS / KIT OPCIONAL PARA CLIMAS FRIOS		
aislamiento isolamento	Código	Precio / Preço
OPTIONAL Kit aislamiento paneles OPTIONAL Kit de isolamento do painel	KBT2F2LDOXXL	

COBERTURA TÉRMICA / TAMPA TÉRMICA			
aislamiento isolamento	Código	Precio / Preço	
		C1	C2
		Plenty Grey	Brown
Cobertura térmica estival Cobertura de verão	DXXTHCO-		
Cobertura térmica invernal Capa de inverno	DXXTHCOT-		

VERSIONE STANDARD

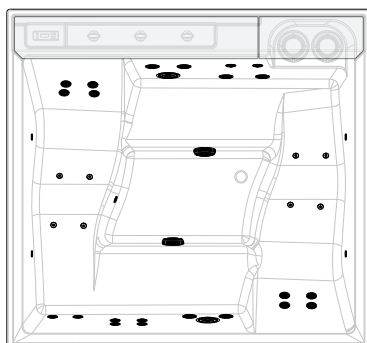

VERSIONE PLUS

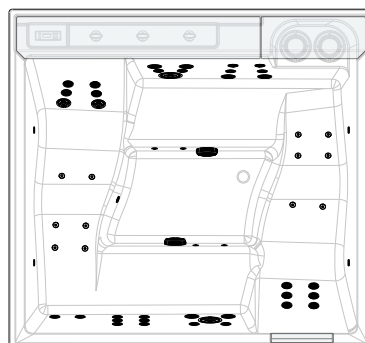



Design by Marco Pellici



Panel de control
Panel de controle



Sistema cromolight & audio
Bluetooth



Posicionamiento del jet
empotrado en el respaldo
*Posicionamento por jacto
encastrados no encosto*

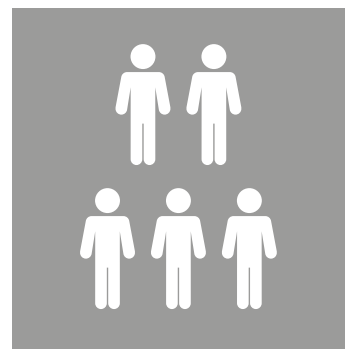

Minipiscina para 5



VITA XL

VITA XL

MINIPISCINA MULTIFUNCIÓN / MINIPISCINA MULTIFUNCIONAL

Dimensiones cm
Dimensões em cm. 200 x 200 H 85







Asientos
Lugares 5

Capacidad litros
Capacidade litros 950













Código	Selección de funciones / Precio Escolha de funções / Preço		Selección Llenado Escolha Preenchimento		Colores de la Minipiscina Cores da Minipiscina	Color del asiento y reposacabezas Cores dos bancos e dos apoios de cabeça
	UV + Cromolight	UV + Cromolight + audio Bluetooth	SIN Llenado automático SEM Preenchimento automático	CON Llenado automático COM Preenchimento automático		
					Blanco Branco	Negro
STANDARD						
	3X	4X	0	1	-W10	H
VITXL50						
STANDARD INTERCAMBIADOR DE CALOR						
	3R	4R	0	1	-W10	H
VITXL50						
PLUS						
	3X	4X	0	1	-W10	H
VITXL40						
PLUS CON INTERCAMBIADOR DE CALOR						
	3R	4R	0	1	-W10	H
VITXL40						

Construcción del código: **Código** + **Selección de funciones** + **Colores de la Minipiscina** + **Color del asiento y reposacabezas** = código producto final
 Construção do código: **Código** + **Escolha de funções** + **Cores da Minipiscina** + **Cores dos bancos e dos apoios de cabeça** = código final do produto

PANELES / PAINÉIS

Código	Selección de paneles Seleção de paineis			
PANELES TACTO NATURAL "NATURAL TOUCH" / PAINÉIS NATURAL TOUCH				
	P1	P2	P3	P4
				
	Oak-Alpine	Oak-Concrete	Oxid	Quarz
PANV2F2LVITXL-				
PANELES ALISTONADOS / PAINÉIS ACABAMENTO MADEIRA				
	D1	D2		
				
	Dark Brown	Ice		
PADV2F2LVITXL-				



FUNCIONES / FUNCIONALIDADES		STANDARD	PLUS
	whirlpool mini jets	4	6
	whirlpool jets	19	28
	Regulación de aire Air settings	-	2
	Chromolight	1	2
	Reposacabezas Apoio de cabeça	-	●
	Sistema audio stereo + bluetooth Integrated audio system + Bluetooth	OPTIONAL	OPTIONAL
	Módulo Wi-Fi Modulo Wi-Fi	OPTIONAL	OPTIONAL
	Sistema de purificación UV UV purification system	●	●
	Bomba de doble velocidad Double speed pump	●	●
	Calentador de 3 KW Aquecedor 3W	●	●
	Intercambiador de calor Intercambiador de calor	OPTIONAL	OPTIONAL
	Llenado automático Preenchimento automático	OPTIONAL	OPTIONAL
	Cobertura Skimmer skimmer cover	-	●

MÓDULO WI-FI / MODULO WI-FI

Código	Precio / Preço
DOMOWF	

KIT AISLAMIENTO FONDO MINIPISCINA / KIT DE ISOLAMENTO DO FUNDO DO TANQUE

Código	Precio / Preço
VXTHCOFV	

KIT OPCIONAL PARA CLIMAS EXTREMOS / KIT OPCIONAL PARA CLIMAS FRIOS

aislamiento isolamento	Código	Precio / Preço
OPTIONAL Kit aislamiento paneles OPTIONAL Kit de isolamento do painel	KBT2F2LVIXL	

COBERTURA TÉRMICA / TAMPA TÉRMICA

aislamiento isolamento	Código	Precio / Preço
Cobertura térmica estival Cobertura de verão	VXTHCO-C2	
Cobertura térmica invernal Capa de inverno	VXTHCOT-C2	

VERSIONE STANDARD

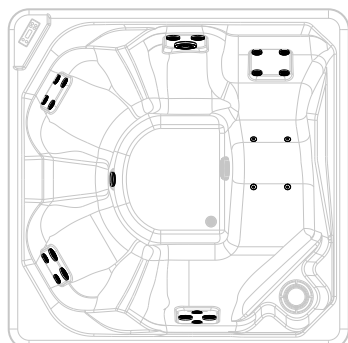

VERSIONE PLUS

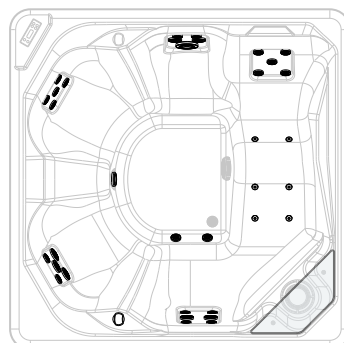



VITA XL | ACABADOS PANELES

COLOR DE LA MINI-
PISCINA / CORES DA
MINIPISCINA

ASIENTO Y REPOSACABEZAS
- APOIA-CABEÇAS

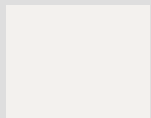

Blanco
Branco

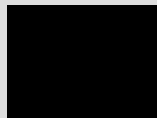

Negro

PANELES TACTO NATURAL "NATURAL TOUCH"
PAINÉIS NATURAL TOUCH



Oak Alpine



Oak Concrete

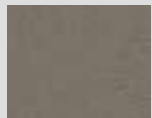

Oxid

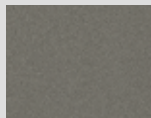

Quarz

PANELES ALISTONADOS
PAINÉIS ACABAMENTO MADEIRA

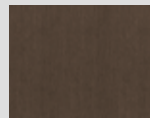

Dark brown

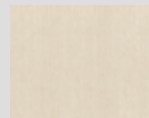

Ice

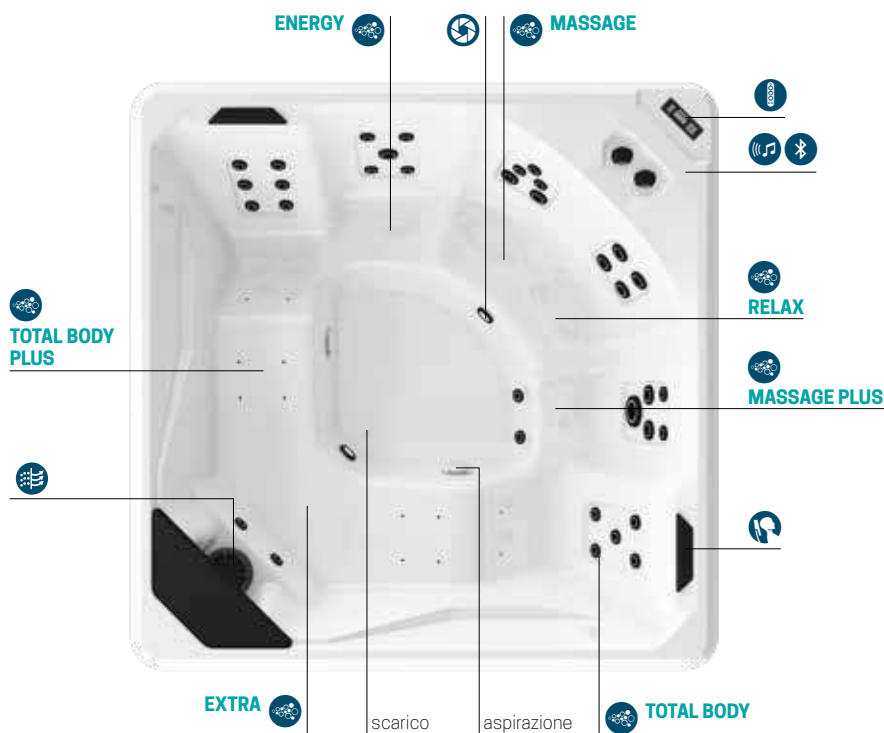

Masaje Airpool mediante jets de aire con regulación manual on/off o programa secuencial, para una **estimulación celular eficaz**.



Massagem Airpool através de jets de ar com regulação manual on/off ou programa sequencial, para uma **estimulação celular eficaz**.



Masaje corporal Whirlpool aire/agua con regulación de tiempo e intensidad manual o automática para satisfacer cualquier necesidad de bienestar.



Massagem corpo Whirlpool ar/agua com regulação de tempo e intensidade manual ou automática.



Filtro desnatador de agua
Escumadeira de filtro de água



4 Cromolight con 8 variaciones de color para activar la mente y excitar el espíritu.



4 Cromolight com 8 variações de cor para activar a mente e excitar o espírito.



Panel de control
Painel de controle



Reposacabezas
Apoia-cabeças

Asiento con control de desagüe

Assento com controlo de drenagem

Altavoces de audio Bluetooth

4 internos y 4 externos

Altifalantes áudio Bluetooth

4 internos e 4 externos



Design by Marco Pellici



Panel de control
Panel de controle



Sistema cromolight & audio
Bluetooth



Posicionamiento del jet
empotrado en el respaldo
*Posicionamento por jacto
encastrados no encosto*

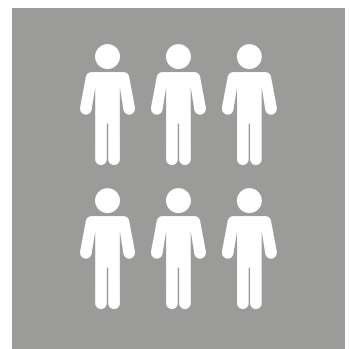

Minipiscina para 6 + 1 extra



VITA XXL

VITA XXL

MINIPISCINA MULTIFUNCIÓN / MINIPISCINA MULTIFUNCIONAL

Dimensiones cm
Dimensões em cm. 215 x 215 H 85





Asientos
Lugares 6+1







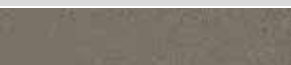
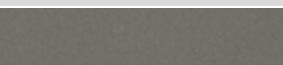







Capacidad litros
Capacidade litros 1150

Código	Selección de funciones / Precio Escolha de funções / Preço		Selección Llenado Escolha Preenchimento		Colores de la Minipiscina Cores da Minipiscina	Color del asiento y reposacabezas Cores dos bancos e dos apoios de cabeça
	UV + Cromolight	UV + Cromolight + audio Bluetooth	SIN Llenado automático SEM Preenchimento automático	CON Llenado automático COM Preenchimento automático		
					Blanco Branco	Negro
STANDARD						
	3X	4X	0	1	-W10	H
VITXXL50						
STANDARD INTERCAMBIADOR DE CALOR						
	3R	4R	0	1	-W10	H
VITXXL50						
PLUS						
	3X	4X	0	1	-W10	H
VITXXL40						
PLUS CON INTERCAMBIADOR DE CALOR						
	3R	4R	0	1	-W10	H
VITXXL40						

Construcción del código: **Código** + **Selección de funciones** + **Colores de la Minipiscina** + **Color del asiento y reposacabezas** = código producto final
 Construção do código: **Código** + **Escolha de funções** + **Cores da Minipiscina** + **Cores dos bancos e dos apoios de cabeça** = código final do produto

PANELES / PAINÉIS

Código	Selección de paneles Seleção de painéis			
PANELES TACTO NATURAL "NATURAL TOUCH" / PAINÉIS NATURAL TOUCH				
	P1	P2	P3	P4
				
	Oak-Alpine	Oak-Concrete	Oxid	Quarz
PANV2F2LVITXXL-				
PANELES ALISTONADOS / PAINÉIS ACABAMENTO MADEIRA				
	D1	D2		
				
	Dark Brown	Ice		
PADV2F2LVITXXL-				

FUNCIONES / FUNCIONALIDADES		STANDARD	PLUS
	whirlpool mini jets	8	12
	whirlpool jets	24	34
	Regulación de aire Air settings	-	2
	Chromolight	1	2
	Reposacabezas Apoio de cabeça	-	•
	Sistema audio stereo + bluetooth Integrated audio system + Bluetooth	OPTIONAL	OPTIONAL
	Módulo Wi-Fi Modulo Wi-Fi	OPTIONAL	OPTIONAL
	Sistema de purificación UV UV purification system	•	•
	Bomba de doble velocidad Double speed pump	•	•
	Bomba de velocidad única Single-speed pump	-	•
	Calentador de 3 KW Aquecedor 3W	•	•
	Intercambiador de calor Intercambiador de calor	OPTIONAL	OPTIONAL
	Llenado automático Preenchimento automático	OPTIONAL	OPTIONAL
	Cobertura Skimmer skimmer cover	-	OPTIONAL

MÓDULO WI-FI / MODULO WI-FI

Código	Precio / Preço
DOMOWF	

KIT AISLAMIENTO FONDO MINIPISCINA / KIT DE ISOLAMENTO DO FUNDO DO TANQUE

Código	Precio / Preço
VXXTHCOFV	

KIT OPCIONAL PARA CLIMAS EXTREMOS / KIT OPCIONAL PARA CLIMAS FRIOS

aislamiento isolamento	Código	Precio / Preço
OPTIONAL Kit aislamiento paneles OPTIONAL Kit de isolamento do painel	KBT2F2LVIXXL	

COBERTURA TÉRMICA / TAMPA TÉRMICA

aislamiento isolamento	Código	Precio / Preço
Cobertura térmica estival Cobertura de verão	VXXTHCO-C2	
Cobertura térmica invernal Capa de inverno	VXXTHCOT-C2	

VERSIONE STANDARD

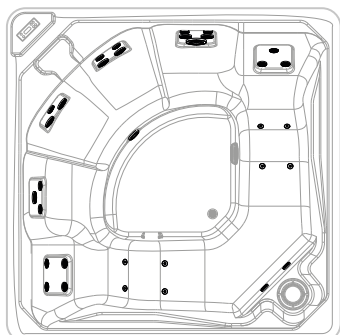

VERSIONE PLUS

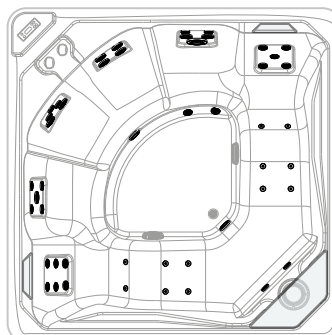



X 187 cm
Y 84 cm
Z 60 cm

CHAISE LONGUE

Chaise longue realizada con multiestrato de abedul con pintura de protección Oxid wood / Quarz wood, colchoneta enfundada con revestimiento antideslizante Fiber-Cross y estructura de acero Negro mate.

Chaise longue em contraplacado de bétula com verniz protector Madeira de boi/ madeira de quartzo, colchão estofado com revestimento antiderrapante Fibracruzada e estrutura de aço preto mate

Código	Estructura estilo Oxid Estructura modo Oxid			Estructura estilo Quarz Estructura modo Quarz		
	P3T1	P3T2	P3T3	P4T1	P4T2	P4T3
	Light Grey	Warm Brown	Steel	Light Grey	Warm Brown	Steel

CHAISE LONGUE	
CHLOD001-	



X 90 cm
Y 40 cm
Z 33 cm

MESITA / QUADRO

**MESA AUXILIAR CON TOALLERO
MESA LATERAL COM TOALHEIRO**

Mesita realizada con multiestrato de abedul con pintura de protección Oxid wood / Quarz wood, colchoneta enfundada con revestimiento antideslizante Fiber-Cross y estructura de acero Negro mate.

Mesa em contraplacado de bétula com revestimento protector Madeira de boi/ madeira de quartzo, colchão estofado com revestimento antiderrapante Fibracruzada e estrutura de aço preto mate

Código	Precio / Preço	
	P3	P4
	Oxid wood	Quarz wood

MESITA / QUADRO	
TAVDOS01-	
MESA AUXILIAR CON TOALLERO / MESA LATERAL COM TOALHEIRO	
TAVDOS02-	

2 barras toalleros
2 toalhetes

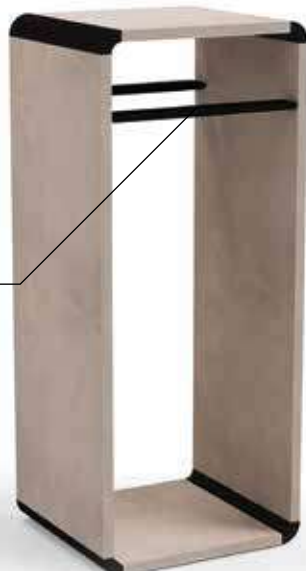

X 40 cm
Y 90 cm
Z 33 cm



DE ESCALÓN ALTO
DEGRAU ALTO

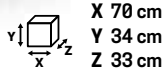

X 70 cm
Y 34 cm
Z 33 cm



DE ESCALÓN BAJO
DEGRAU BAIXO

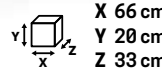

X 66 cm
Y 20 cm
Z 33 cm



DE DOBLE ESCALÓN
DEGRAU DUPLO

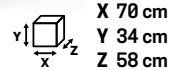

X 70 cm
Y 34 cm
Z 58 cm

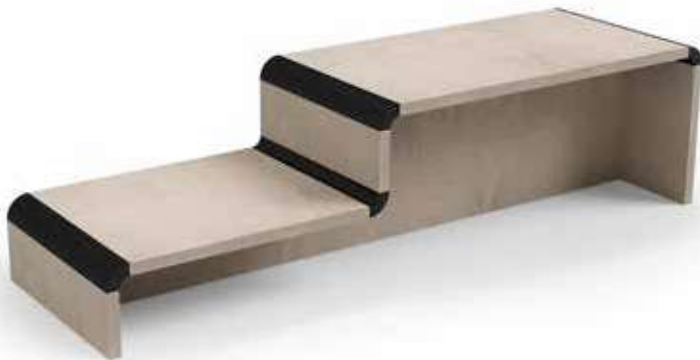

DE ESCALÓN DOBLE LATERAL
DEGRAU DOBRO LATERAL

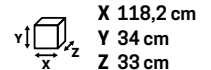

X 118,2 cm
Y 34 cm
Z 33 cm



PROLONGACIÓN LATERAL / PROLONGAÇÃO LATERAL

combinable con la de escalón doble lateral
pode ser combinado com
o passo lateral duplo

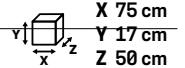

X 75 cm
Y 17 cm
Z 50 cm



ESCALERAS AUXILIARES / DEGRAU POR OPÇÃO

Realizadas con multicapa de abedul con pintura de protección Oxid wood / Quarz wood y piezas de unión de aluminio Negro mate

Degraus em contraplacado de bétula com verniz protector Madeira de Oxid / Quarz madeira e acessórios de alumínio Preto mate



ADVERTENCIA: LOS ACCESORIOS DE MADERA CONTRACHAPADA DEBEN TRATARSE DOS VECES AL AÑO CON EL KIT DE MANTENIMIENTO ADECUADO. VER PÁGINA 647

AVISO: OS ACESSÓRIOS QUE SÃO FEITOS DE CONTRAPLACADO DEVEM SER TRATADOS DUAS VEZES POR ANO COM O KIT DE MANUTENÇÃO APROPRIADO. VER PÁGINA 647

Código	Precio / Preço	
	P3	P4
	Oxid wood	Quarz wood

DE ESCALÓN ALTO / DEGRAU ALTO		
SCADOSC1-		
DE ESCALÓN BAJO / DEGRAU BAIXO		
SCADOSC2-		
DE DOBLE ESCALÓN / DEGRAU DUPLO		
SCADOSC3-		
DE ESCALÓN DOBLE LATERAL / DEGRAU DUPLO LATERAL		
SCADOSC4-		
PROLONGACIÓN LATERAL / PROLONGAÇÃO LATERAL		
SCADOSC5-		



MESITA / QUADRO

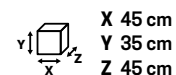

Código	Precio / Preço			
	P1	P2	P3	P4
	Oak-Alpine	Oak-Concrete	Oxid	Quarz
TAVVIT01-				



DE ESCALÓN ALTO / DEGRAU ALTO

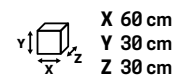

Código	Precio / Preço			
	P1	P2	P3	P4
	Oak-Alpine	Oak-Concrete	Oxid	Quarz
SCAVIT01-				



DE ESCALÓN BAJO / DEGRAU BAIXO

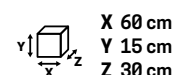

Código	Precio / Preço			
	P1	P2	P3	P4
	Oak-Alpine	Oak-Concrete	Oxid	Quarz
SCAVIT02-				



DE DOBLE ESCALÓN / DEGRAU DUPLO

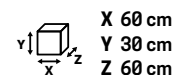

Código	Precio / Preço			
	P1	P2	P3	P4
	Oak-Alpine	Oak-Concrete	Oxid	Quarz
SCAVIT03-				

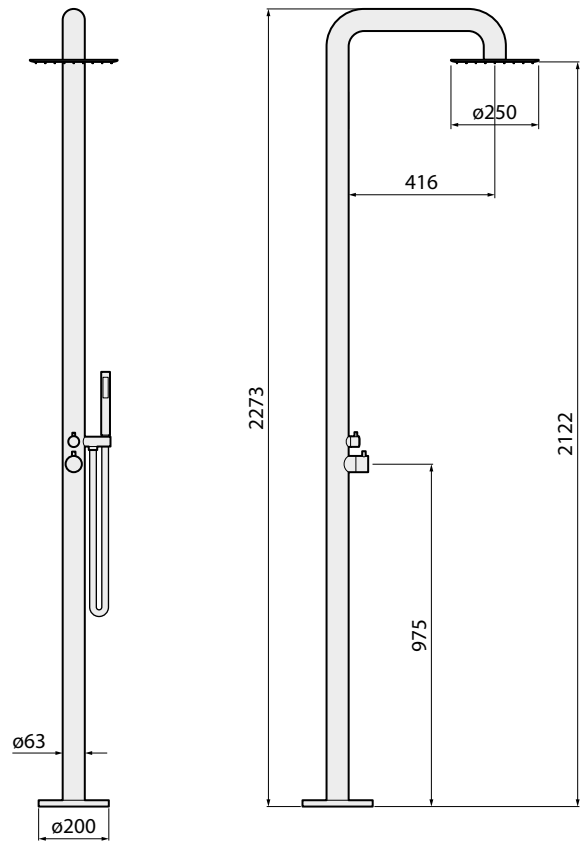

COLUMNA DE DUCHA EXTERIOR
COLUNA DE DUCHE EXTERIOR

Columna de ducha de acero inoxidable con mezclador monomando y distribuidor incorporados, ducha fija efecto lluvia y ducha de mano con flexo antitorsión

Coluna de duche em aço inoxidável com misturador e desviador mecânico incorporado, chuveiro de chuva e chuveiro manual de jacto único com mangueira flexível anti-torção.

Código
DOCDOS



KIT DE CLORO BÁSICO / KIT BASICO CLORO

- 1 Kg. de Cloro Multiacción / 1 kg de *chlore Multi-action*
- 750 gr. de reductor de PH granulado / *Redutor de PH granular de 750 gr*
- Reagentes / *Reagentes*

Código
DOKIWT



KIT DE CLORO COMPLETO / KIT PLUS CLORO

- 1 Kg. de pastillas de cloro de 20 gr. de acción higienizante. / *Pastilhas de cloro 20 g (acção desinfectante) - 1 Kg*
- 500 ml. de reductor de pH líquido / *Redutor de pH líquido 500 m*
- 200 ml. de Silicona antiespumante / *Antiespumante de silicone 200 ml*
- Top 5 multi-acción, producto multi-función anti-algas, floculante, anticalcáreo, colorante azul / *Top 5 multiacção, produto multifuncional contra algas, floculante, anti-escala, agente azulado*
- Verificador de Cloro/pH / *Testador de cloro/PH*
- Dosificador de 0-30 ml / *copo de medição graduado 0-30 ml*

Código
DOKIEC



PRO KIT (para minipiscina con filtro de arena)

- 1 Kg. de pastillas de cloro de 20 gr. de acción higienizante. / *Pastilhas de cloro 20 g (acção desinfectante) - 1 Kg*
- 1l. de reductor de pH líquido / *Redutor de pH líquido 1l.*
- 200 ml. de Silicona antiespumante / *Antiespumante de silicone 200 ml*
- Alga clean Plus 500 ml
- Super Floc 500 ml
- Chlorine/pH/Alcalinity tester in litmus strips
- Dosificador de 0-30 ml / *copo de medição graduado 0-30 ml*

Código
DOKIPR



IDRO PH+

- Para aumentar el pH del agua. 1 litro. / *Liquido para acrescentar PH agua: 1l*
- Dosificador de 0-30 ml / *Doseador de 0-30 ml*

Código
DOPH1L



KAL STOP

- Anti-calcáreo no espumante. 1 litro. / *Antincalcareo não espumante: 1l*
- Dosificador de 0-30 ml / *Doseador de 0-30 ml*

Código

DOCAST



FILTER CLEAN RAPID

- Producto para la limpieza del filtro de cartucho con pulverizador. 500 ml.
Produto para limpeza do filtro do cartucho com vaporizador 500 ml.

Código

DOFICR



IDRO SANIT SHOCK

- Limpiador Desinfectante anti-calcáreo y antibacteriano para sistemas de hidromasaje en minipiscinas - 5 litros
Anti-escala e anti-bactericida/detergente para sistemas de hidromassagem SPA 5 lt

Código

DOIDSS



2 FILTROS SKIMMER

- Conjunto de 2 cartuchos para el filtrado mecánico del agua, para insertar en el Skimmer
Pacote de 2 cartuchos para filtragem mecânica da água a inserir no skimmer

Código

DIVINA SPA M e L

DOFISK2

DIVINA SPA XL e XXL

DXFISK2



SISTEMA PARA EL CUIDADO DE LOS COMPLEMENTOS DE EXTERIOR

- Kit para renovar las superficies de los muebles de jardín a base de sustancias de limpieza y cuidado con efecto repelente de agua, aceite y suciedad.

Código

DOKIMA



FUNDA DE PROTECCIÓN / CAPA DE PROTEÇÃO

MOON

Código
MOCOPR

DIVINA M SPA

Código
DOMCOPR

DIVINA L SPA

Código
DOLCOPR

DIVINA XL SPA

Código
DOXCOPR

DIVINA XXL SPA

Código
DOXXCOPR

VITA XL

Código
VXCOPR

VITA XXL

Código
VXXCOPR

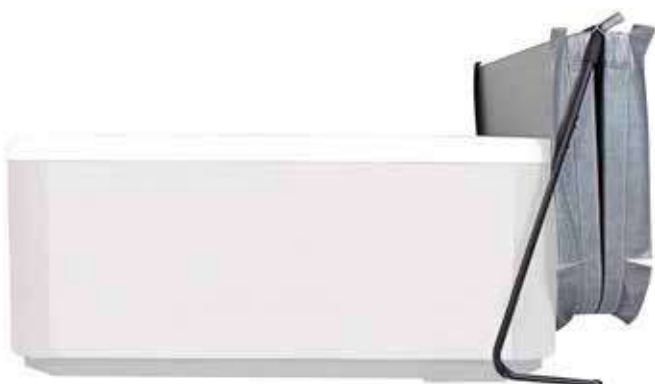

VOLTEADOR PARA COBERTURA / TURNER PARA COBERTURA

(por Divina Spa y Vita)

Código

**VOLTEADOR PARA COBERTURA /
TURNER PARA COBERTURA**
DOTHCORE

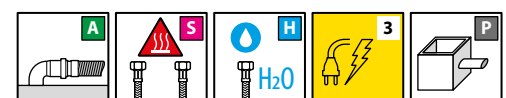
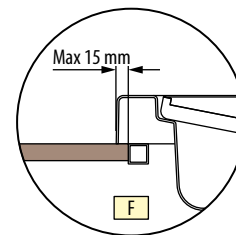
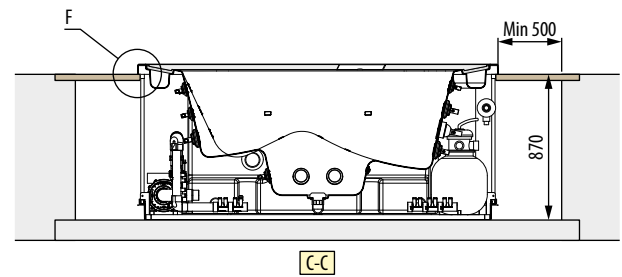
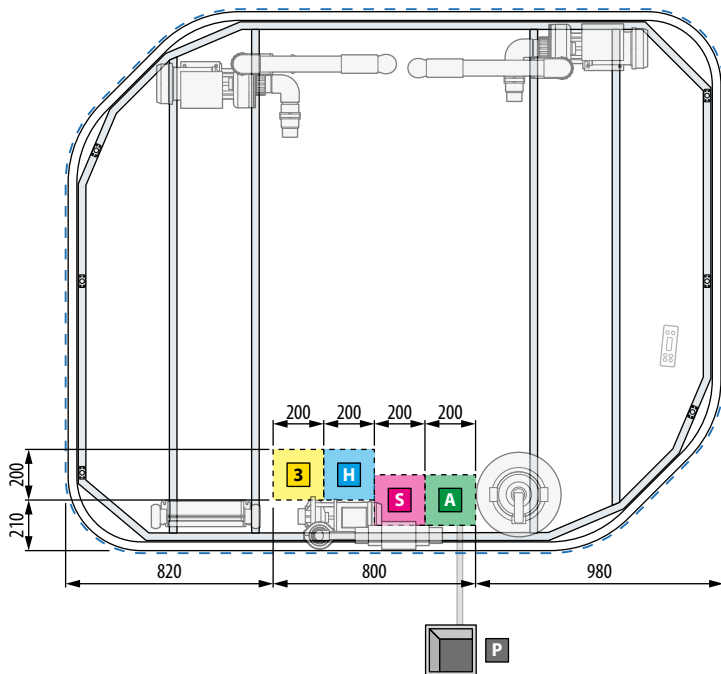
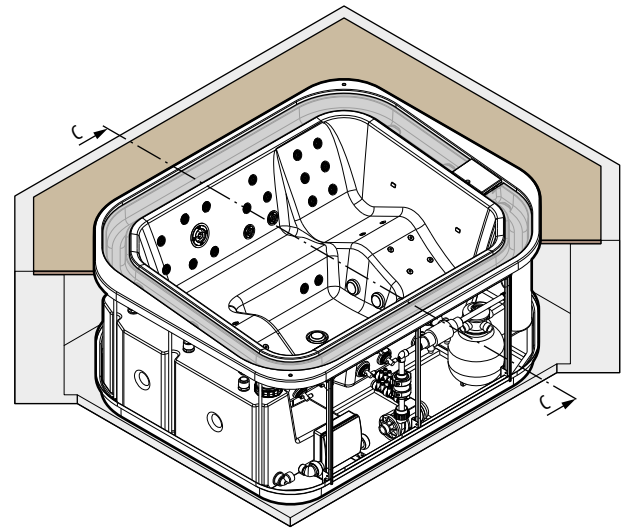
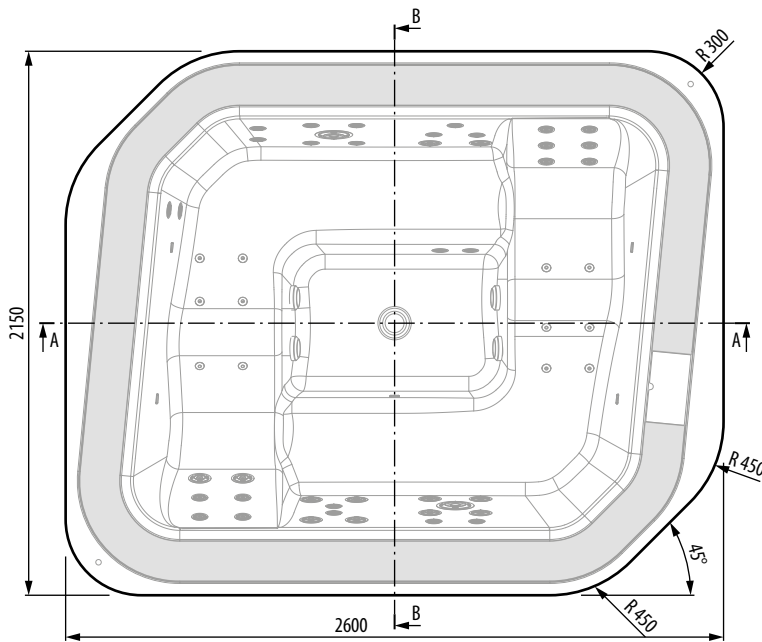
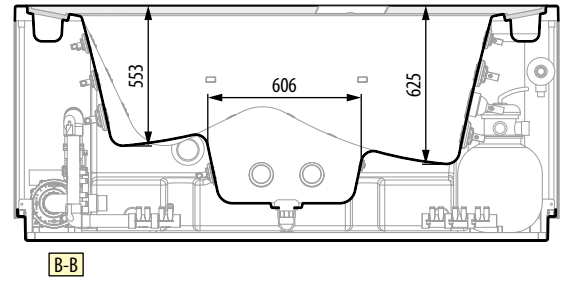
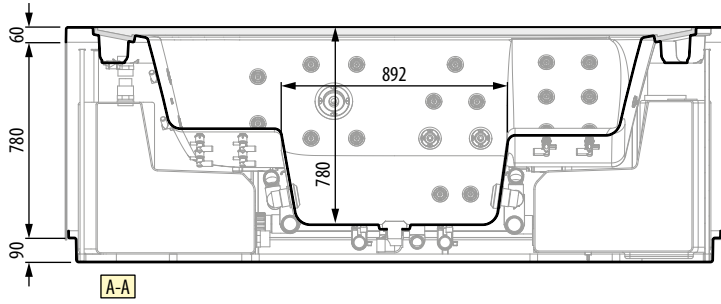

CARACTERÍSTICAS HIDRÁULICAS

Capacidad media 1690 lt
37 jets whirlpool
16 mini jet

CARACTERÍSTICAS ELÉCTRICAS

Tensión 230 V
Frecuencia 50 Hz
Potencia máx. requerida 4500 W

CARACTERÍSTICAS MECÁNICAS

Área total 4.85 m²
Peso total: 2620 kg
Peso Minipiscina+componentes 450 kg
Peso usuarios(6 pers.) 80x6=480 kg
Carga específica en base de apoyo 5290 N/m²

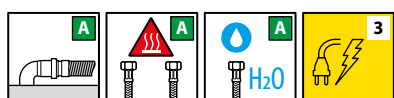
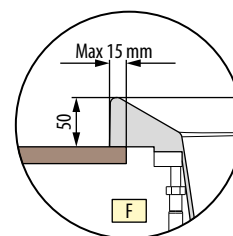
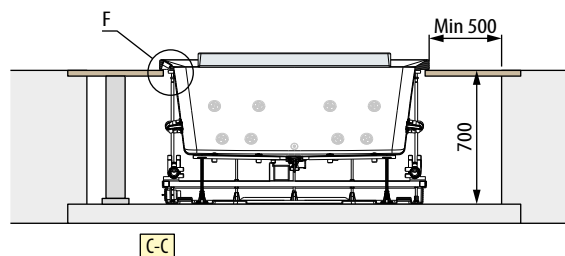
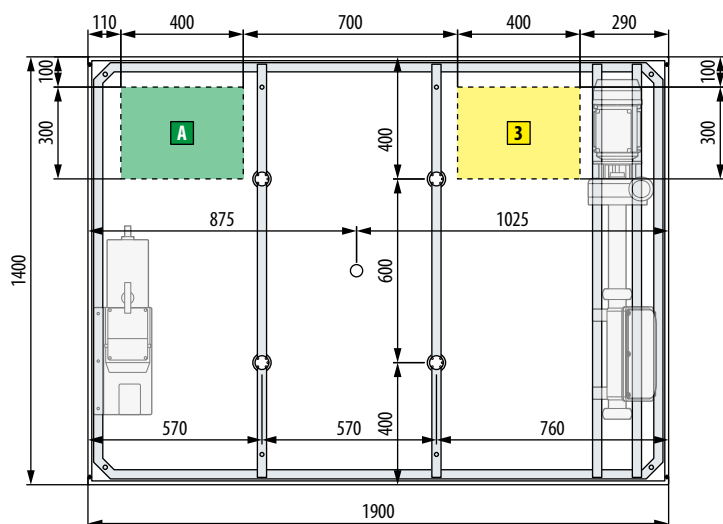
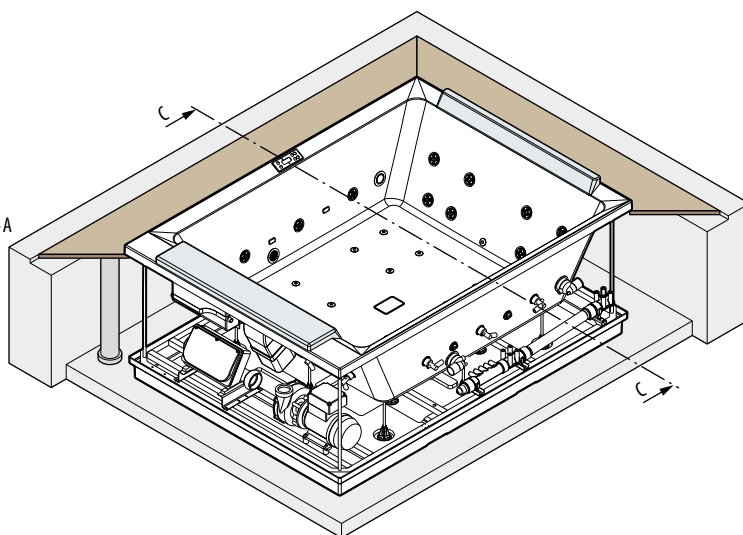
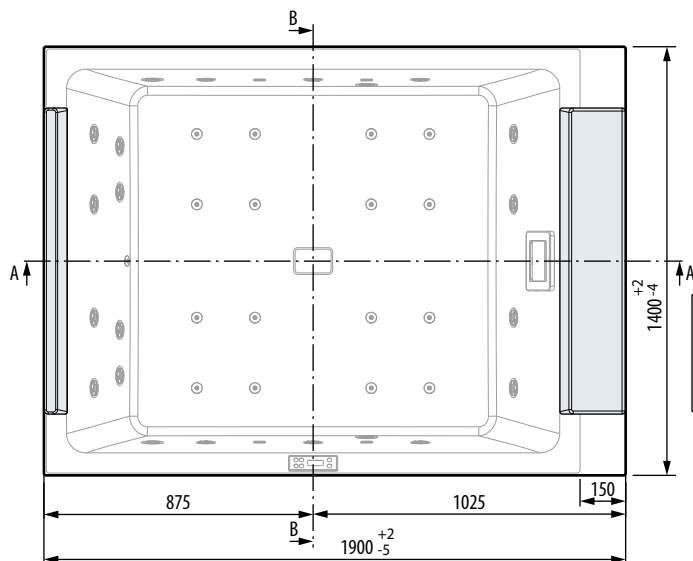
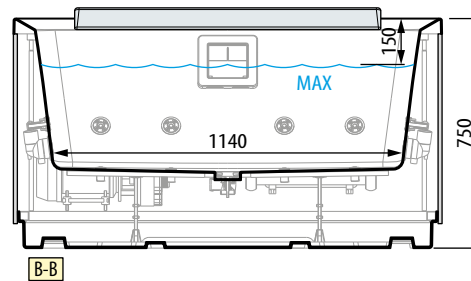
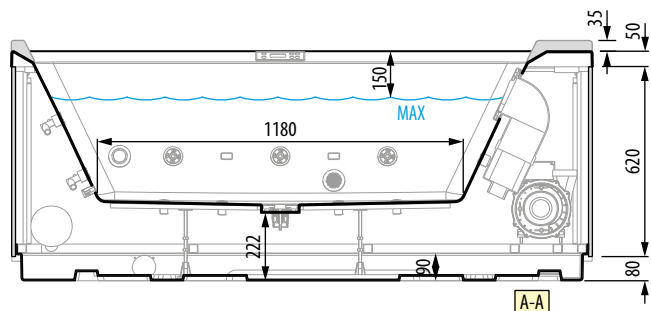

CARACTERÍSTICAS HIDRÁULICAS

Capacidad máxima 550 lt
 18 jets jets Whirlpool laterales (18 vers. st.)
 16 jets mini-jets en el fondo (0 vers. st.)
 2 jets Natural Air

CARACTERÍSTICAS ELÉCTRICAS

Tensión 230 V
 Frecuencia 50 Hz
 Potencia máx. absorbida calentador +
 bomba a baja velocidad: 2400 W

CARACTERÍSTICAS MECÁNICAS

Área total 2.66 m²
 Peso total: 960 kg
 Peso Minipiscina+componentes 250 kg
 Peso usuarios(2 pers.) 80+80 kg
 Carga específica en base de apoyo 3610 N/m²

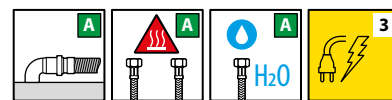
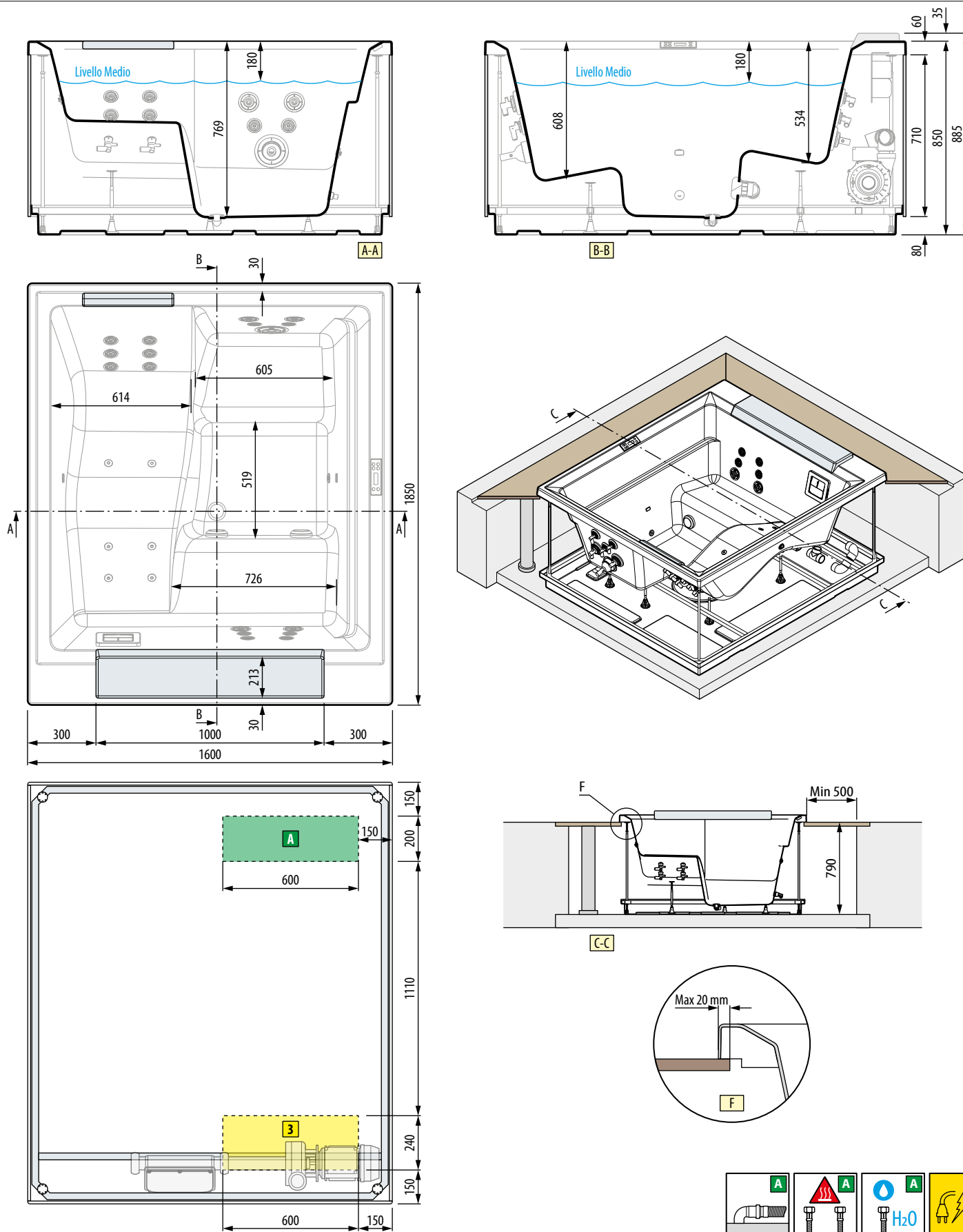

CARACTERÍSTICAS HIDRÁULICAS

Capacidad media 680 lt
 17 jets whirlpool (12 en versión standard)
 6 jets mini jet (4 en versión standard)

CARACTERÍSTICAS ELÉCTRICAS

Tensión 230 V
 Frecuencia 50 Hz
 Potencia máx. requerida 2400 W

CARACTERÍSTICAS MECÁNICAS

Área total 3.0 m²
 Peso total: 1200 kg
 Peso Minipiscina+componentes 290 kg
 Peso usuarios(3 pers.) 80x3=240 kg
 Carga específica en base de apoyo 4090 N/m²

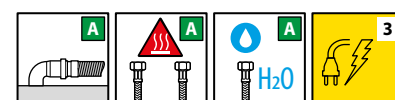
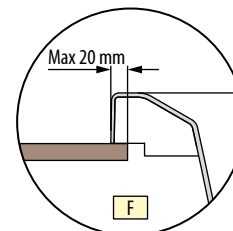
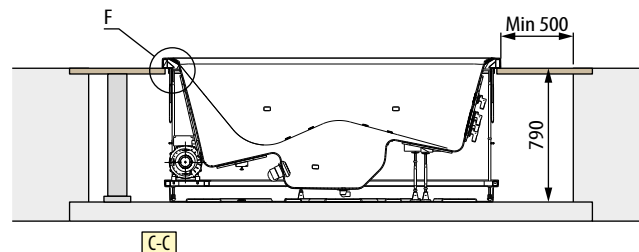
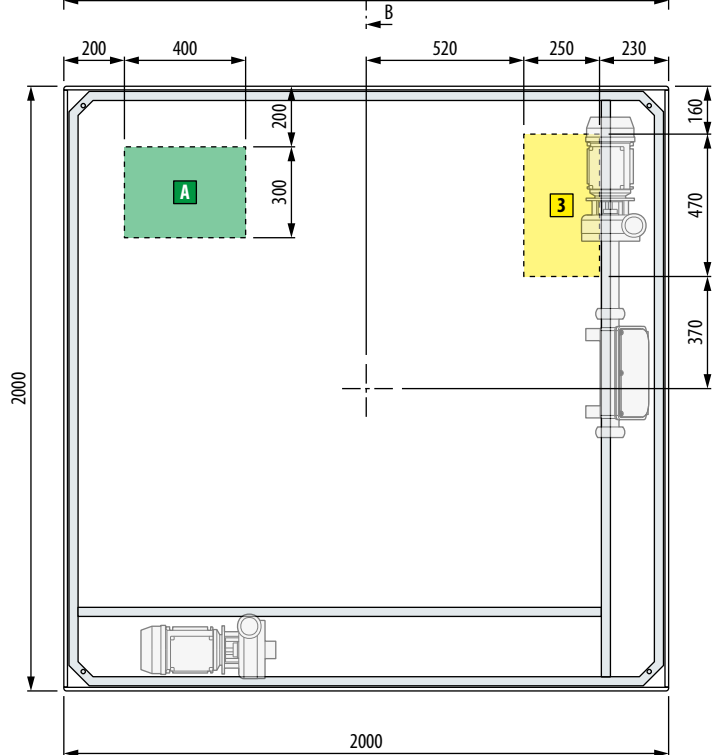
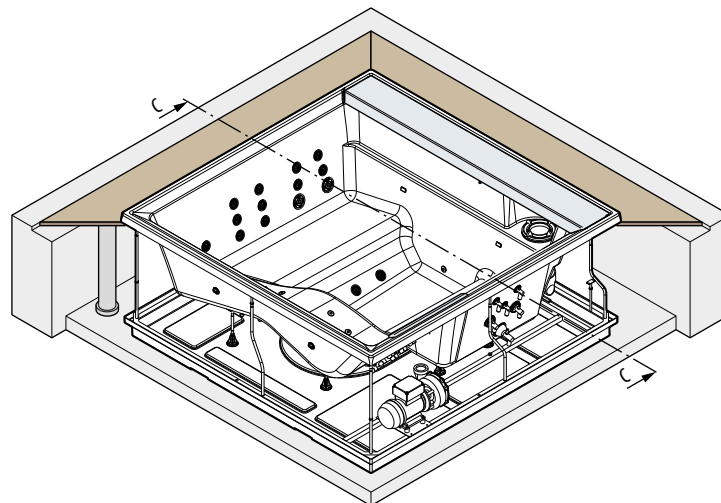
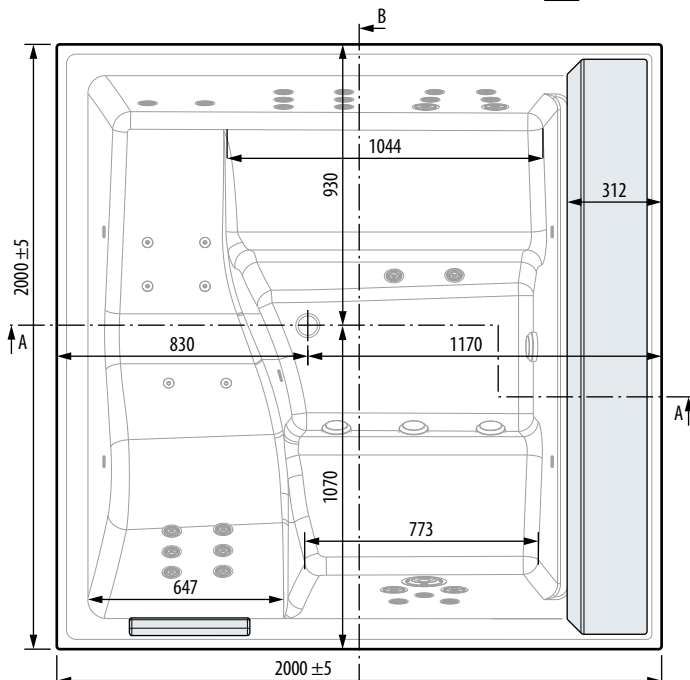
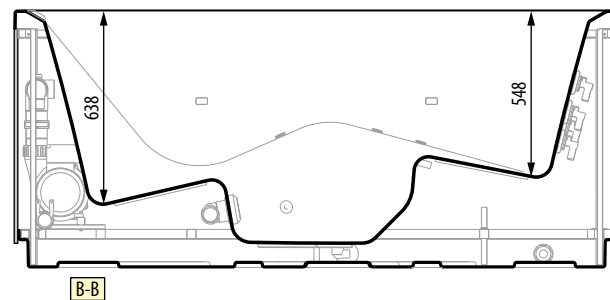
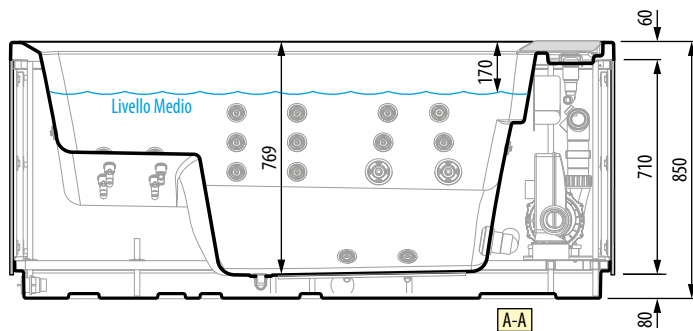

CARACTERÍSTICAS HIDRÁULICAS

Capacidad media 930 lt
28 jets whirlpool (18 en versión standard)
8 jets mini jet (4 en versión standard)

CARACTERÍSTICAS ELÉCTRICAS

Tensión 230 V
Frecuencia 50 Hz
Potencia máx. requerida 3450 W

CARACTERÍSTICAS MECÁNICAS

Área total 4 m²
Peso total: 1610 kg
Peso Minipiscina+componentes 300 kg
Peso usuarios(4 pers.) 80x4=380 kg
Carga específica en base de apoyo 4030 N/m²

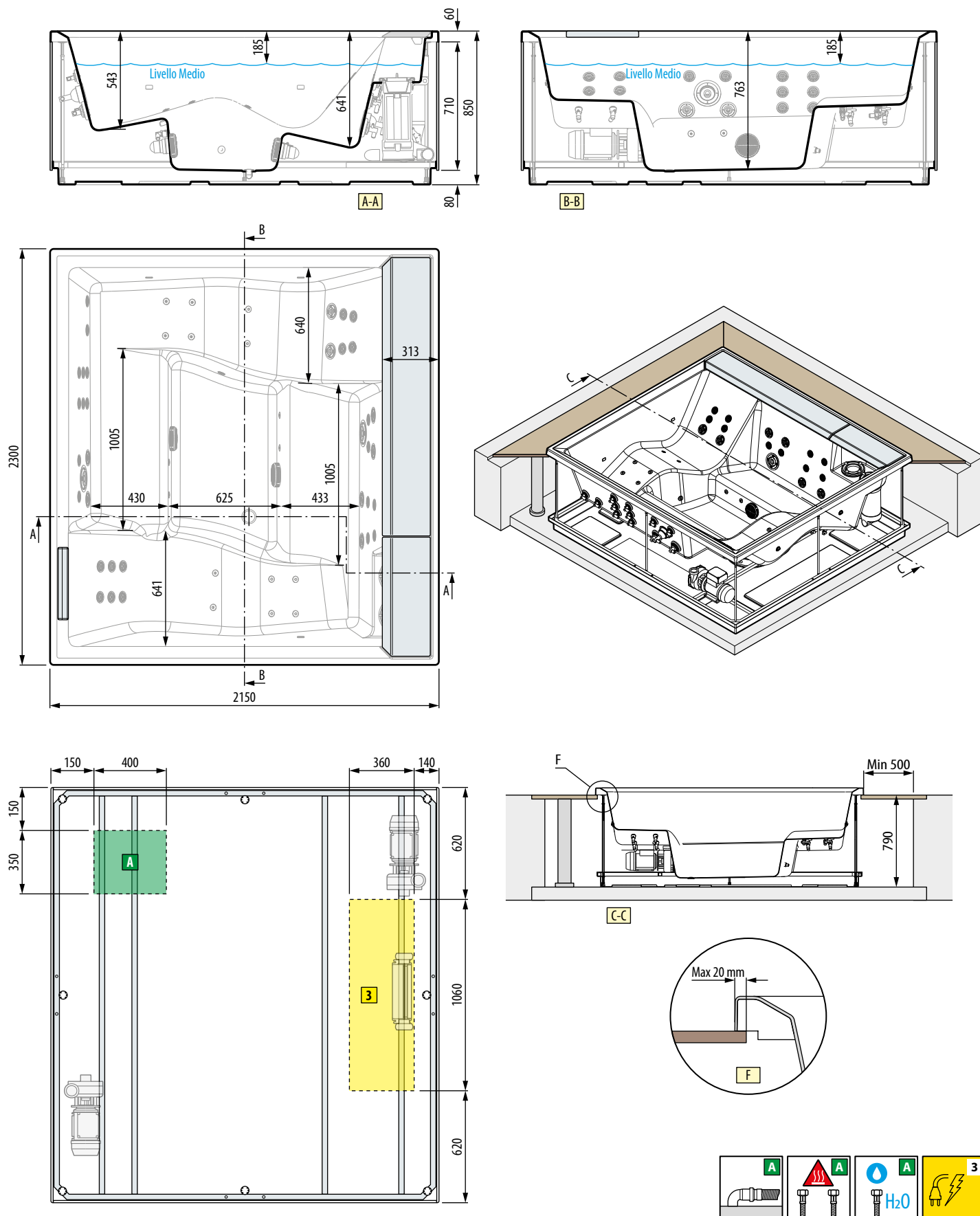

CARACTERÍSTICAS HIDRÁULICAS

Capacidad media 1160 lt
 36 jets whirlpool (24 en versión standard)
 16 jets mini jet (8 en versión standard)

CARACTERÍSTICAS ELÉCTRICAS

Tensión 230 V
 Frecuencia 50 Hz
 Potencia máx. requerida 3450 W

CARACTERÍSTICAS MECÁNICAS

Área total 4.9 m²
 Peso total: 2080 kg
 Peso Minipiscina+componentes 460 kg
 Peso usuarios(6 pers.) 80x6=480 kg
 Carga específica en base de apoyo 4210 N/m²

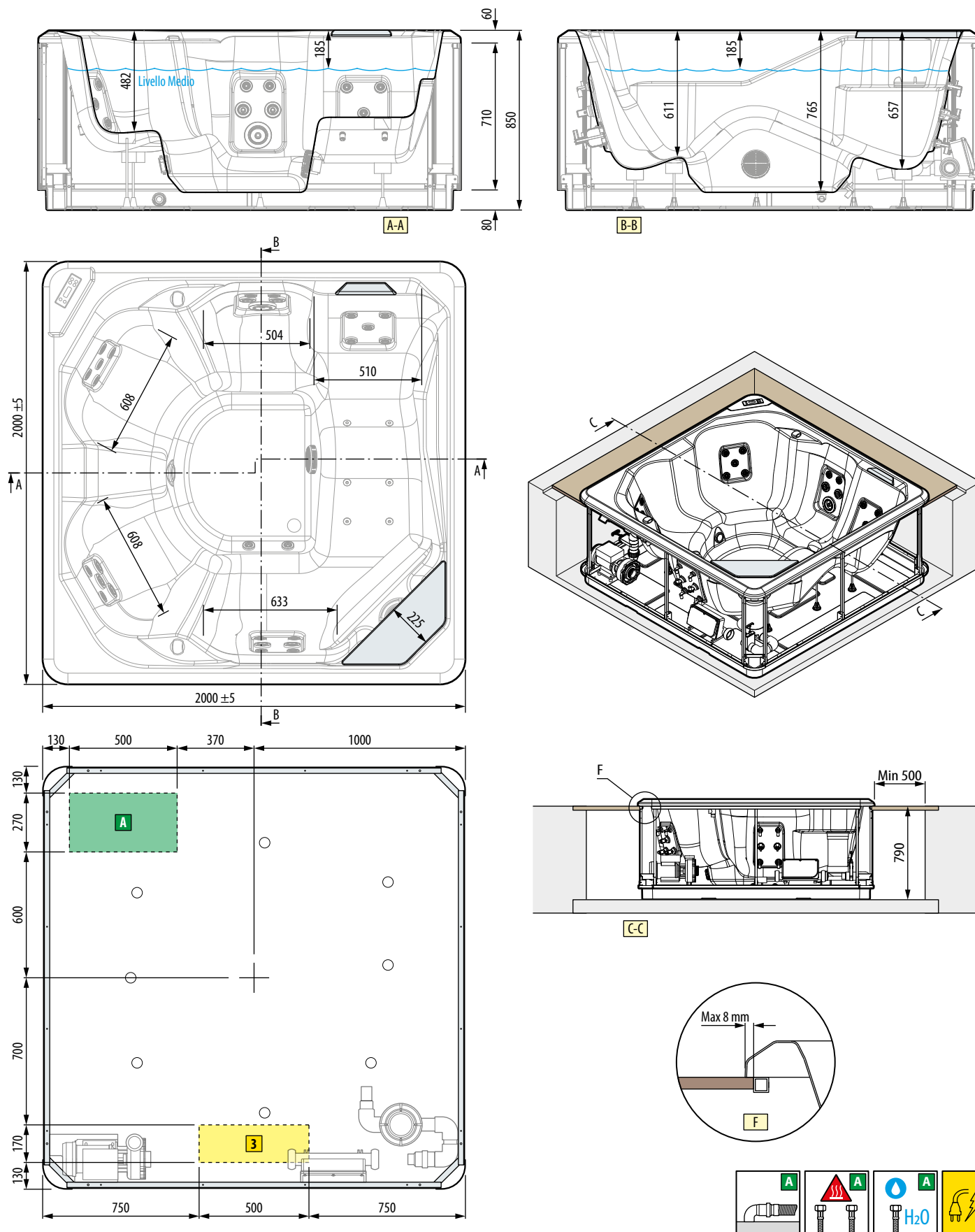

CARACTERÍSTICAS HIDRÁULICAS

Capacidad máxima 950 lt
 28 jets jets Whirlpool laterales (19 vers. st.)
 6 jets mini-jets en el fondo (4 vers. st.)

CARACTERÍSTICAS ELÉCTRICAS

Tensión 230 V
 Frecuencia 50 Hz
 Potencia máx. requerida 3450 W

CARACTERÍSTICAS MECÁNICAS

Área total 4 m²
 Peso total: 1650 kg
 Peso Minipiscina+componentes 300 kg
 Peso usuarios(5 pers.) 80x5=400 kg
 Carga específica en base de apoyo 4130 N/m²

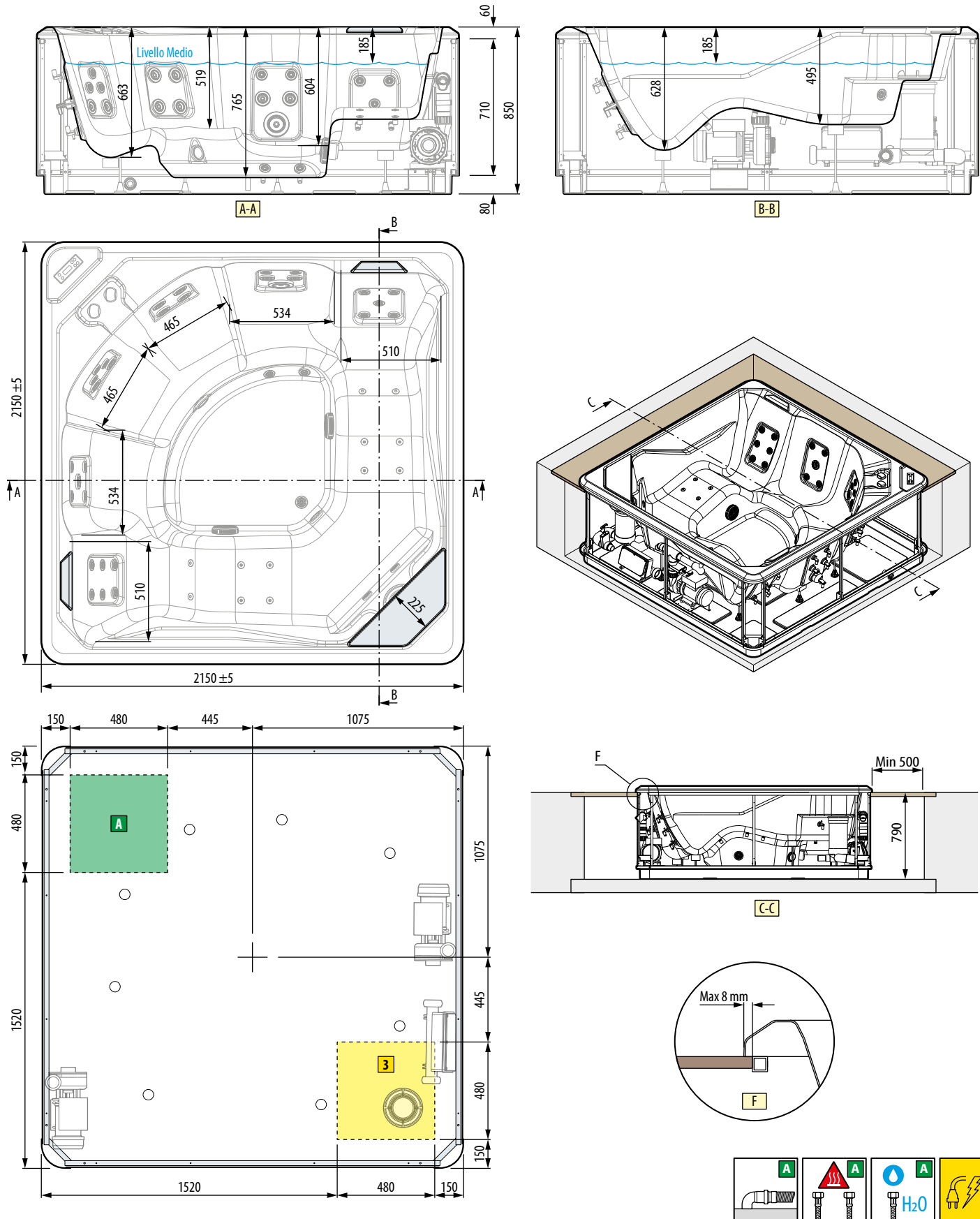

CARACTERÍSTICAS HIDRÁULICAS

Capacidad máxima 1150 lt
 34 jets jets Whirlpool laterales (24 vers. st.)
 12 jets mini-jets en el fondo (8 vers. st.)

CARACTERÍSTICAS ELÉCTRICAS

Tensión 230 V
 Frecuencia 50 Hz
 Potencia máx. requerida 3450 W

CARACTERÍSTICAS MECÁNICAS

Área total 4,6 m²
 Peso total: 1980 kg
 Peso Minipiscina+componentes 350 kg
 Peso usuarios(6+1 pers.) 80x6=480 kg
 Carga específica en base de apoyo 4280 N/m²

CALIDAD Y SEGURIDAD / QUALIDADE E SEGURANÇA

NUESTRO COMPROMISO CON TU SEGURIDAD

Todos nuestros productos han sido proyectados y realizados para cumplir con las exigencias de las normas europeas más recientes en materia de calidad y seguridad. Las materias primas y semielaborados, el montaje de los diversos componentes, cada fase está perfectamente planificada, monitorizada y revisada para garantizar siempre unos resultados al máximo nivel dentro de los valores standard exigidos por el mercado internacional. Los materiales utilizados en el embalaje son completamente reciclables conforme a la norma 94/62/CE.

Un compromiso cotidiano que intenta corresponder a la fidelidad de todos nuestros clientes.

SAUNA DE VAPOR HÚMEDO

Las saunas de vapor húmedo Novellini son conformes a las siguientes directivas Europeas: **UE 305/2011, 2014/35/UE, 2014/30/UE, 2014/53/UE.**

Con referencia a las normas armonizadas:

EN 60335-1
EN 60335-2-105
EN 62233
EN 60479
EN 55014-1
EN 55014-2
EN 61000-3-2
EN 61000-3-3
EN 301 489-17V3.2.0
EN 301 489-1V2.2.0
EN 300 328 V2.1.1



MATERIALES PLÁSTICOS

Todos los materiales plásticos utilizados en la producción de los productos Novellini (Acrílico, Metacrilato, ABS, etc.) se someten a exhaustivos controles para verificar sus cualidades, el espesor y la homogeneidad.

RADIADOR SOLE

Los radiadores son conformes a las siguientes directivas europeas: **UE 305/2011, 2014/35/UE, 2014/30/UE, 2014/53/UE, 2009/125/CE (reglamento UE2015/1188).** Con referencia a las normas armonizadas:

EN 60335-1
EN 60335-2-30
EN 62233
EN 60479
EN 55014-1
EN 55014-2
EN 61000-3-2
EN 61000-3-3
EN 301 489-17 V3.2.0
EN 301 489-1 V2.2.0
EN 300 328 V2.1.1



Los paneles de ducha y los platos Novellini de fabricación propia son conformes al nuevo Reglamento UE 305/2011

Las paredes de ducha y los platos Novellini de fabricación propia son conformes al nuevo Reglamento UE 305/2011

SE PROHÍBE PONER SILICONA EN EL INTERIOR DE LAS MAMPARAS DE DUCHA.

SAUNA DE VAPOR HUMIDO

As saunas de vapor húmedo Novellini, estão conforme as seguintes diretivas Europeas: **UE 305/2011, 2014/35/UE, 2014/30/UE, 2014/53/UE..**

Com referencia as normas armonizadas:

EN 60335-1
EN 60335-2-105
EN 62233
EN 60479
EN 55014-1
EN 55014-2
EN 61000-3-2
EN 61000-3-3
EN 301 489-17V3.2.0
EN 301 489-1V2.2.0
EN 300 328 V2.1.1



MATERIALES PLÁSTICOS

Todos os materiais plasticos utilizados na produção dos productos Novellini (acrílico, metacrilato, abs, etc.), são submetidos a exaustivo controle para verificar as suas qualidades, espessura e homogeneidade.

RADIADOR SOLE

Os radiadores Sole estão sujeitos às seguintes normas europeas: **UE 305/2011, 2014/35/UE, 2014/30/UE, 2014/53/UE, 2009/125/CE (reglamento UE2015/1188)** Com referencia as normas armonizadas:

EN 60335-1
EN 60335-2-30
EN 62233
EN 60479
EN 55014-1
EN 55014-2
EN 61000-3-2
EN 61000-3-3
EN 301 489-17 V3.2.0
EN 301 489-1 V2.2.0
EN 300 328 V2.1.1



Os painéis de duche e os pratos Novellini de fabricação própria são conformes ao novo Regulamento UE 305/2011

As paredes de duche e os pratos Novellini de fabricação própria são conformes ao novo Regulamento UE 305/2011

NÃO É ACONSELHAR UTILIZAR SILICONE, NAS VEDAÇÕES PELO INTERIOR DOS RESGUARDOS

O NOSSO COMPROMISSO COM A TUA SEGURIDADE

Todos os nossos productos foram projectados e realizados para cumprir com as exigencias e normas europeias mais recentes em matéria de qualidade e segurança.

As matérias primas e semielaborados, as montagens dos diversos componentes, em cada fase, está perfectamente planificada, monitorizada e controlada, para garantir sempre resultados ao máximo nivel, dentro dos valores standard exigidos pelo mercado internacional.

Os materiais usados nas embalagens, são completamente recicláveis conforme a norma 94/62/CE.

BAÑERAS DE HIDROMASAJE BANHEIRAS DE HIDROMASSAGE

Las bañeras de hidromasaje Novellini son conformes a las siguientes directivas Europeas: **NORMAS UE 305/2011, 2014/35/UE, 2014/30/UE, 2014/53/UE.** Con referencia a las normas armonizadas

As banheiras de hidromassagem Novellini, são conforme as seguintes directivas Europeas: **NORMAS UE 305/2011, 2014/35/UE, 2014/30/UE, 2014/53/UE..** Com referencia as normas armonizadas:

EN 12764:2018
EN 60335-1
EN 60335-2-60
EN 62233
EN 60479
EN 55014-1
EN 55014-2
EN 61000-3-2
EN 61000-3-3
EN 301 489-17 V3.2.0
EN 301 489-1 V2.2.0
EN 300 328 V2.1.1



CE
Novellini Spa - Via Mantova, 1023 46034 - Borgo Virgilio Loc. Romanore Mantova - Italy 07
EN 12764:2018
Hidromasaje de baño, destinado al uso para la higiene personal. Hidromassagem de banho, destinado ao uso e higiene pessoal
Resistencia al atrapamiento de los cabellos: pasa Resistencia ao entupimento pelos cabelos:
Cualidades de limpieza: pasa Qualidade de limpeza
Durabilidad de la limpieza: pasa Durabilidade de limpeza

MAMPARAS DE DUCHA / PLATOS DE DUCHA RESGUARDOS DE DUCHE / BASES DE CHUVEIRO

Las mamparas de ducha para uso doméstico de fabricación propia son conformes a la Norma Europea **UNE EN14428** (Paneles de Ducha - Requisitos funcionales y métodos de ensayo). Esta declaración se basa en la conformidad de productos según la siguiente norma: **EN 14428:2018**, Con referencia a las normas armonizadas.

Os resguardos de duche para uso doméstico de fabricação própria são conforme as Normas Europeas **UNE EN14428** (Painéis de duche - Requisitos Funcionais e métodos de ensaio). Esta declaração se baseia com a conformidade de productos da seguinte norma; **EN 14428:2018**, Con referencia a las normas armonizadas:

EN12150-1:2019
ISO 7599
EN ISO 2409
ISO7892

CE
Novellini Spa - Via Mantova, 1023 46034 - Borgo Virgilio Loc. Romanore Mantova - Italy
EN 14428 :2018+A1

PLATOS DE DUCHA / BASES DE CHUVEIRO

Los platos de ducha Novellini de fabricación propia para uso doméstico son conformes a la norma **Los platos de ducha Novellini de fabricación propia para uso doméstico son conformes a la norma EN 14527:2019**

CE
Novellini Spa - Via Mantova, 1023 46034 - Borgo Virgilio Loc. Romanore Mantova - Italy
12
EN 14527-CL 1

ANEXO B: Cuando la superficie del plato de ducha esta mojada, aumenta el riesgo de resbalar, de forma particular cuando se utiliza jabón, shampoo, aceites de baño, etc. Es importante que las personas que realizan los proyectos, así como los instaladores y usuarios, sean conscientes de ello.

ANNEX B: Quando molhadas, a maioria das bases de duche, aumenta o risco de escorregar, e de forma particular, quando se utiliza sabão, shampoo, e oleos de banho, etc. É importante que todos os intervinientes na realização dos projectos, instaladores e utilizadores, estejam conscientes deste facto.

DIRECTIVA REACH

(Registro, Evaluación y Autorización de Sustancias Químicas) Aplicación del Reglamento nº 1907/2006

El 1 de Junio de 2007 entró en vigor en toda la Unión Europea el nuevo sistema de regularización (REACH - REGLAMENTO (CE) N. 1907/2006) para la valoración, el registro y control de las emisiones de sustancias y preparados químicos en el mercado europeo. Con este sistema se prevé que todas las sustancias químicas producidas o importadas en la Unión Europea en una cantidad superior a 1 tonelada/año deban ser registradas a través de la Agencia Europea de la Química (ECHA). Después de hacer uso durante un período transitorio en el cuál será posible preparar el dossier de registro, es necesario realizar el registro preliminar antes del 01.12.08. Se recuerda que, si en el plazo establecido no ha sido efectuado el pre-registro, la sustancia en cuestión no podrá ser colocada en el mercado hasta que no se haya realizado el registro.

Con este objetivo, se comunica que la Novellini, S.p.a. desempeña únicamente el papel de usuario, no produciendo o importando sustancias en el marco de la Unión Europea, y por lo tanto no debe asumir las obligaciones relativas al registro de dichas sustancias. Con el fin de garantizar la continuidad en el suministro de nuestros productos, con la presente queremos comunicarles que estamos

asegurando que nuestros proveedores, en aquellos casos que corresponda, efectúen el mencionado pre-registro. En el supuesto que esto no se produjera, sustituiríamos las sustancias utilizadas por otras que respondan a los requisitos de las normas vigentes. En todo caso, nuestro suministro no sufrirá modificación alguna al margen de las obligaciones REACH.

Por lo que se refiere a nuestros productos, todos están incluidos en la definición de artículo según el Reglamento (CE) N.1907/2006 del Parlamento Europeo y del Consejo del 18 de diciembre de 2006. En particular, al art. 7 "Registro y notificación de las sustancias contenidas en los artículos", coma 1, letra b). Estos artículos no están sujetos a registro en cuanto que las eventuales sustancias en ellas contenidas no están destinadas a ser entregadas en condiciones de uso normal o razonablemente previsibles.

Se especifica además que, siempre según el Reglamento (CE) N. 1907/2006, los mencionados artículos, en base a sus características, no están sujetos a las obligaciones previstas en el art.33 "Obligación de comunicar informaciones de las sustancias presentes en los artículos" en tanto que el porcentaje en peso de la sustancia considerada peligrosa, según la presente normativa, es inferior al 0,1% del peso total del artículo.

CONDICIONES GENERALES DE VENTA

PEDIDOS

Las descripciones y fotografías contenidas en este catálogo deben entenderse únicamente a nivel informativo. NOVELLINI IBÉRICA S.L.U. se reserva el derecho a modificar parcial o totalmente los productos en cualquier momento y sin previo aviso.

Los pedidos se considerarán en firme transcurridas 24 horas de su recepción.

ANULACIÓN

No se aceptarán anulaciones del pedido. En caso contrario NOVELLINI IBÉRICA S.L.U. se reserva el derecho de facturar los eventuales gastos ocasionados.

PEDIDOS ESPECIALES

Los pedidos de productos especiales deben cursarse siempre por escrito y deben ir acompañados de un anticipo mínimo del 25% del importe total de los mismos. BAJO NINGÚN CONCEPTO SE ACEPTARÁN ANULACIONES DE DICHS PEDIDOS.

PLAZOS DE ENTREGA

Los plazos de entrega son puramente informativos y no supondrán en ningún caso motivo de anulación total o parcial del pedido, ni motivo de reclamación con responsabilidades a ningún efecto. En los casos en que el plazo de entrega sea indispensable para el comprador, deberá especificarlo por escrito en el momento de cursar el pedido.

PRECIOS Y CONDICIONES DE PAGO

Los precios de venta son los indicados en la tarifa vigente en el momento de la recepción del pedido. NOVELLINI IBÉRICA S.L.U. se reserva el derecho de revisar y variar dichos precios incluso sin previo aviso.

Primeras operaciones: Hasta la concesión de la oportuna clasificación y riesgo, todas las operaciones serán abonadas mediante pago anticipado.

Operaciones posteriores: A pactar específicamente con cada cliente. Máximo 60 días. En caso de atraso en el pago se cargarán los intereses legales correspondientes.

TRANSPORTE

La pérdida o daños que pueda sufrir la mercancía vendida son a cargo del comprador a partir del momento en que queda a su disposición, o sea desde la entrega al transportista, aunque el transporte sea a cargo de NOVELLINI IBÉRICA S.L.U.

EMBALAJE

Los precios pactados para los productos NOVELLINI IBÉRICA S.L.U. se entienden incluyendo un embalaje normal. En caso de exigencias particulares de transporte y, en consecuencia, de embalaje, se pactará un precio especial en función del coste añadido soportado. Los palets metálicos utilizados para el transporte de los productos NOVELLINI IBÉRICA S.L.U., se consideran "retornables" en tanto que propiedad del vendedor. En caso de no ser restituidos, NOVELLINI IBÉRICA S.L.U. se reserva la facultad de cargar su valor. Dichos palets metálicos han sido proyectados para uso exclusivo de productos de NOVELLINI IBÉRICA S.L.U., quien se exime de toda responsabilidad derivada del uso impropio de los mismos.

Esta tarifa anula y sustituye a las anteriores. Las imágenes y otros contenidos en este catálogo deben considerarse indicativos y pueden sufrir modificaciones sin previo aviso

GARANTÍA

NOVELLINI IBÉRICA S.L.U. garantiza sus productos por falta de conformidad durante un período de tres años a partir del 01 de enero de 2022 y a contar desde la fecha de entrega de los mismos. El comprador deberá efectuar su reclamación dentro de los dos meses siguientes a la aparición del defecto o falta de conformidad, lo que deberá hacer mediante carta/escrito dirigido a la garante a las señas que constan en el presente documento. El comprador tiene derecho a reclamar la reparación, sustitución del bien, rebaja del precio o la resolución del contrato en los términos y condiciones establecidas en el Real Decreto Ley 07/2021 de 27/04/2021 (Ley General para la Defensa de los consumidores y Usuarios). La presente garantía, que no afecta a los derechos de que dispone el consumidor conforme a las previsiones de la indicada Ley, es válida para todo el territorio español. La garantía no cubre deterioros no imputables al producto o derivados de negligencia en su manipulación.

DEVOLUCIONES

No se aceptará ninguna devolución que no haya sido previamente autorizada por NOVELLINI IBÉRICA S.L.U., y que no vaya acompañada del documento que así lo justifique (AUTORIZACIÓN DE DEVOLUCIÓN). Para la obtención de dicho documento será necesario haber comunicado a nuestras oficinas de forma detallada y específica para cada producto o artículo el motivo que justifique dicha devolución. Las devoluciones deberán consignarse a destino a portes pagados. En los casos de devoluciones improcedentes, NOVELLINI IBÉRICA S.L.U. se reserva el derecho de pasar cargo al cliente de los gastos ocasionados.

En caso de devoluciones por errores del cliente, serán a cargo del destinatario los costes correspondientes, alrededor del 30% del valor neto de la mercancía, por gastos generales de retorno y realmacenaje, siempre y cuando el producto esté en perfectas condiciones. En caso que el producto resulte dañado o no esté en perfectas condiciones, NOVELLINI IBÉRICA S.L.U. se reserva valorar periódicamente el valor a acreditar.

IMPUESTOS

Serán cargados en la factura según la legislación vigente.

JURISDICCIÓN

El cliente acepta las condiciones anteriores en el momento de cursar el pedido. Serán únicamente competentes, en caso de litigio, los Tribunales de Barcelona. Todos los productos están asegurados contra los daños que puedan ocasionar al consumidor conforme a la directiva comunitaria CEE 85/374 de 1985, con XL Group - Insurance Company PLC.

En situaciones de falsa escuadra o suelo, NOVELLINI IBÉRICA S.L.U. declina toda responsabilidad en caso de eventuales dificultades, imposibilidad de instalar el producto, pérdidas de agua o mal funcionamiento. La empresa no se responsabiliza de eventuales defectos de funcionamiento producidos por un incorrecto montaje de los componentes.

NOVELLINI IBÉRICA S.L.U. se reserva el derecho de aportar a los productos modificaciones parciales o totales e incluso retirarlo del catálogo sin previo aviso. La decoración y la tonalidad de los colores de las fotografías son puramente indicativas.

DIRECTIVA REACH

(Registo, Evolução e Autorização de Substancias Químicas) Aplicação do Regulamento^o 1907/2006

Estimado cliente

Em, 1 de junho de 2007, entrou em vigor em toda a União Europeia, o novo sistema de regulação (REACH – REGLAMENTO (CE) N. 1907/2006) N. 1907/2006), para a valoração do registo e control das emissões de substancias e preparados químicos no mercado europeu. Com este sistema se prevê que todas as substancias químicas produzidas ou importadas na União Europeia numa quantidade superior a 1 tonelada/ano, devam ser registadas através da Agencia Europeia da Quimica (ECHA)

Depois de fazer uso durante um periodo transitório no qual será possível preparar o dossier de registo, é necessário realizar o registo preliminar antes de 01.12.08. Record-se que, se no prazo estabelecido não for efectuado o pré-registo, a substancia em questão não poderá ser colocada no mercado até que seja realizado o registo.

Com este objectivo, comunica-se que a Novellini, S.p.A., desempenha unicamente o papel de utilizador, não produzindo ou importando substancias no espaço da União Europeia, e portanto não deve assumir as obrigações relativas ao registo das ditas substancias.

Com o fim de garantir a continuidade no fornecimento dos nossos productos, informamos que estamos a tentar garantir que os nossos

fornecedores, nos casos que lhes diga respeito, efectuem o registo. No caso em tal não se verifique, substituiremos as substancias utilizadas, por outras que respondam as requisitos das normas vingentes. Em todo o caso, o nosso fornecimento não sofrerá modificação alguma á margen das obrigações REACH.

No que se refere aos nossos productos, todos estão incluídos na definição de artigo, segundo o Regulamento (CE) N.1907/2006, do Parlamento Europeu e da reunião de 18 de Dezembro de 2006. Em particular o art. 7 “Registo e notificação das substancias contidas nos artigos”, § 1, letra b). estes artigos não estão sujeitos a registo enquanto que as eventuais substancias neles contidos, não são destinadas a ser entregues em condições de uso normal, ou razoavelmente previstas.

Alem disso, especifica que segundo o Regulamento (CE) N. 1907/2006, os mencionados artigos, em base nas suas características, não estão sujeitos ás obrigações previstas no art. 33 “Obrigações de comunicar informações das substancias presentes nos artigos” na percentagem em peso da substancia considerada perigosa, segundo a presente normativa, ser inferir a 0.1% do peso total do artigo.

CONDIÇÕES GERAIS DE VENTA

ENCOMENDAS

As descrições e fotografias apresentadas nesta tabela tem que ser entendidas unicamente a nível informativo. NOVELLINI IBÉRICA S.L.U. reserva-se o direito de modificar parcial o totalmente os produtos em qualquer momento e sem previo aviso. As encomendas consideraran-se confirmadas passadas 24 horas da sua recepção.

ANULAÇÃO

Não serão aceites anulações. No caso contrario, NOVELLINI IBÉRICA S.L.U. reserva-se o direito de facturar os eventuais gastos ocasionados.

ENCOMENDAS ESPECIAIS

As encomendas de produtos especiais devem ser enviadas sempre por escrito e devem ser acompanhados de pagamento do 25% do valor total dos mesmos. EM CASO ALGUM SERÃO ACEITES ANULAÇÕES DAS DITAS ENCOMENDAS.

PRAZOS DE ENTREGA

Os prazos de entrega são puramente informativos, e não é suposto em nenhum caso motivo de anulação total o parcial do pedido, nem motivo de reclamação com responsabilidades. No caso em que o prazo de entrega seja indispensavel, deverá ser especificado no pedido.

PREÇOS E CONDIÇÕES DE PAGAMENTO

Os preços de venda são os indicados na tabela em vigor no momento da recepção da encomenda. NOVELLINI IBÉRICA S.L.U. tem o direito de alterar e variar ditos preços inclusive sem previo aviso.

CONDIÇÕES DE PAGAMENTO

Primeiras operações: Até a concessão, classificação e risco, todas as operações serão pagas mediante pronto pagamento. Operações posteriores: A acordar especificamente com cada cliente. Máximo 60 dias. No caso de atraso no pagamento será debitado o valor dos juros legais correspondentes

TRANSPORTE

Aa perda ou danos que possa sofrer a mercadoria, são por conta do comprador a partir do momento em que fica à sua disposição, ou seja desde a entrega ao transportista, embora o transporte seja por conta de NOVELLINI IBÉRICA S.L.U.

EMBALAGEM

Os preços acordados para os productos NOVELLINI IBÉRICA S.L.U. entendem-se incluindo uma embalagem normal. No caso de exigencias particulares de transporte e consequentemente de embalagem, será combinado um preço especial em função do custo acrescentado suportado. As paletes metalicas utilizadas para o transporte dos productos NOVELLINI IBÉRICA S.L.U. consideram-se “retornaveis” e propriedade do vendedor. No caso de não ser devolvido NOVELLINI IBÉRICA S.L.U. reserva-se o direito de debitar o seu valor. As mesmas paletes metalicas são de uso exclusivo dos productos NOVELLINI IBÉRICA S.L.U. que não assume responsabilidade pelo uso indevido das mesmas.

Esta tabela anula e substitui o anterior. As imagens e dados contidos neste catálogo deverão ser considerados indicativos e podem sofrer alterações sem aviso prévio.

GARANTIA

NOVELLINI IBÉRICA S.L.U. os seus produtos por falta de conformidades durante um período de tres anos a partir do 01 de Janeiro e a contar desde a data de entrega dos mesmos. O comprador terá de efectuar a sua reclamação dentro dos dois meses seguintes à detecção do defeito ou falta de conformidade, o que deverá ser feito mediante uma carta/escrito dirigida ao vendedor. O comprador tem direito a reclamar a reparação, substituição do bem, rebaixa do preço ou a resolução do contrato nos termos e condições estabelecidas na Lei 84/2021 do 18 de octubre de 2021. A presente garantia, que não afecta aos direitos de que dispõe o consumidor conforme às previsões a indicada Lei, é válida para todo o território português. A garantia não cobre estragos não imputaveis ao produto, ou derivados de negligência na sua manipulação.

DEVOLUÇÕES

Não serão aceites nenhuma devolução que não tenha sido previamente autorizada por NOVELLINI IBÉRICA S.L.U., e que não venha acompanhada do documento que o justifique (AUTORIZAÇÃO DE DEVOLUÇÃO).

Para a obtenção de dito documento será necessario ter comunicado aos nossos escritorios de forma detalhada e especifica para cada produto ou artigo o motivo que justifique dita devolução.

As devoluções deverão ser enviadas a portes pagos.

Nos casos de devoluções não aceites, NOVELLINI IBÉRICA S.L.U. tem o direito de debitar ao cliente os gastos ocasionados.

Em caso de devoluções por erro do cliente, os custos correspondentes serão, aproximadamente do 30% do valor liquido da mercadoria, por despesas de devolução e novo armazenamento, sempre que o produto esteja em perfeitas condições. Em caso que o produto esteja danificado ou não se encontre em perfeitas condições, NOVELLINI IBÉRICA S.L.U., tem o direito de valorizar periódicamente o importe a creditar.

IMPOSTOS

Serão debitados na factura segundo a legislação em vigor.

JURISDIÇÃO











O cliente aceita as condições anteriores no momento de enviar a encomenda. Serão unicamente competentes, no caso de litigio, os Tribunais de Ermesinde. Todos os productos estão assegurados contra os danos que possam ocasionar ao consumidor conforme à directiva comunitaria CEE 85/374 de 1985, com XL Group – Insurance Company PLC.

Em situações de falso esquadro ou solo, NOVELLINI IBÉRICA S.L.U. declina toda responsabilidade em caso de eventuais dificuldades, impossibilidade de instalar o produto, perdas de água ou mau funcionamento.

A empresa não se responsabiliza de eventuais defeitos de funcionamento produzidos por uma incorreta montagem dos componentes.

Novellini se reserva o direito de contribuir aos productos modificações parciais ou totais e inclusive retirá-lo do catálogo sem previo aviso. A decoração e a tonalidade das cores das fotografias são puramente indicativas.

LEYENDA Y SIMBOLOS DE LAS MAMPARAS DESCRICÃO E SIMBOLOS DOS RESGUARDOS

	Altura mampara <i>Altura do resguardo</i>		No reversible (debe especificarse mano) <i>Não reversível</i>		Estanqueidad satisfactoria <i>Estanco satisfatória</i>
	Espesor del cristal <i>Espessura do vidro</i>		Sistema de autoelevación en la apertura y cierre / <i>Dobradiça</i> <i>auto-elevação abertura e fecho</i>		Estanqueidad no garantizada <i>Estanqueidade não</i> <i>garantida 100%</i>
	Extensibilidad <i>Extensibilidade</i>		Soft closing		
	Reversible <i>Reversível</i>		Óptima estanqueidad <i>Ótima estanco</i>		

EYENDA Y SIMBOLOS DE CABINAS DE DUCHA Y COLUMNAS MULTIFUNCION DESCRICÃO E SIMBOLOS DE CABINAS DE DUCHE E COLUNAS MULTIFUNÇÃO

	Altura total de la cabina <i>Altura da cabina</i>		Cascada <i>Cascata</i>		Repisa porta objetos <i>Prateleira porta-objectos</i>
	Altura útil interna <i>Altura útil interna</i>		Sauna de Vapor <i>Sauna de vapor</i>		Reposapiés <i>Apoia-pés</i>
	Espesor del cristal <i>Espessura do vidro</i>		Chromolight <i>Chromolight</i>		Bluetooth
	Hidromasaje vertical y dorsal <i>Hidromassagem vertical e dorsal</i>		Iluminacion interna LED <i>Iluminação interna LED</i>		Radio RDS estéreo con altavoces <i>Radio RDS estéreo com coluna de</i> <i>som</i>
	Hidromasaje cervical <i>Hidromassagem cervical</i>		Mando a distancia "Touch Screen" <i>Comando á distancia "Touch</i> <i>Screen"</i>		Espejo <i>Espelho</i>
	Hidromasaje plantar <i>Hidromassagem plantar</i>		Panel electrónico con función de hidrosecuencia / <i>Painel electrónico</i> <i>com função de hidrosequência</i>		Techo <i>Tecto</i>
	Rotojets tipo lluvia <i>Rotojets tipo chuva</i>		Ducha de mano con flexo <i>Chuveiro de mão com tubo flexível</i>		
	Ducha fija tipo lluvia <i>Duche fixo tipo chuva</i>		Asiento <i>Assento</i>		

LEYENDA Y SIMBOLOS DE LAS BAÑERAS DESCRICÃO E SIMBOLOS DE CABINAS DAS BANHEIRAS

	Hidromasaje airpool <i>Hidromassagem airpol</i>		Re-calentador de agua <i>Aquecimento da água</i>		Asiento <i>Assento</i>
	Hidromasaje Airpool dorsal (aire en el agua) / <i>Hidromassagem Airpol</i> <i>dorsal (ar na água)</i>		Encendido táctil <i>Ligação soft touch</i>		Columna de desagüe (excepto en bañeras para empotrar) / <i>Valvula automatica</i> <i>(excepto nas banheiras de embutir)</i>
	Hidromasaje Whirpool lateral (mezcla de aire agua) / <i>Hidromassagem</i> <i>Whirpool lateral (mistura ar-água)</i>		Desinfección <i>Desinfecção</i>		Válvula click-clack
	Hidromasaje Whirpool dorsal (mezcla de aire-agua) / <i>Hidromassagem</i> <i>Whirpool dorsal (mistura ar-água)</i>		Grifería al borde de la bañera <i>Torneira no rebordo da banheira</i>		Bluetooth
	Hidromasaje Whirpool plantar (mezcla de aire-agua) / <i>Hidromassagem</i> <i>Whirpool plantar (mistura ar-água)</i>		Mando a distancia "Touch Screen" <i>Comando á distancia "Touch</i> <i>Screen"</i>		Radio RDS estéreo con altavoces <i>Radio RDS estéreo com coluna de som</i>
	Natural Air		Panel electrónico con función de hidrosecuencia / <i>Painel electrónico</i> <i>com função de hidrosequência</i>		Toma auxiliar para MP3 <i>Radio RDS estéreo com coluna de</i> <i>som MP3</i>
	Cascada		Mando a distancia ON/OFF <i>Telecomando on/off</i>		Tubo de desagüe anti-gotas <i>Tubo de descarga salvagotas</i>
	Sistema relajante Cromolight <i>Sistema relax Cromolight</i>		Reposa-cabezas, impermeable antibacterias / <i>Apoia-cabeças,</i> <i>impermeável antibacterias</i>		



NOVELLINI IBÉRICA S.L.U.

Can Bruixa 13/15 - 08028 Barcelona
Tel. 93 40 95 500 - 93 33 01 441 | Fax 93 49 13 601 | novellini@novellini.es

Show room Barcelona

Can Bruixa 13/15 - 08028 Barcelona

MADRID

C/Gamonal, 65 - P.I. Vallecas 28031 - Madrid
Tel. 91 38 06 615 | Fax 91 38 06 616 | novellinimadrid@novellini.es

Servicio técnico

Tel. 90 20 26 659

PORTUGAL

Rua das Sobreiras, 55 - 4150-713 Porto - Portugal
tel. 22 97 74 130 | fax 22 97 74 139 | porto@novelliniportugal.com

Servicio técnico

tel. 22 97 74 13 06 59



Designed and
manufactured
in **ITALY**



www.novellini.com



www.novellini.com/facebook



www.novellini.com/instagram



www.novellini.com/YouTube



www.novellini.com/Linkedin



www.novellini.com/Pinterest