



Tarifa 2023



CIPRIANI SCAMBIATORI ESPAÑA S.L.

Tel. Contacto 93.432.38.59

cipriani@cipriani.es

REFERENCIA	Nº PLACAS	LONGITUD (mm)	P.V.P. INOX (€)	P.V.P. TITANIO (€)
S020-05	5	178	546	725
S020-07	7	178	596	819
S020-09	9	178	637	904
S020-11	11	178	685	998
S020-13	13	178	722	1.077
S020-15	15	178	760	1.157
S020-17	17	178	798	1.236
S020-19	19	178	835	1.316
S020-21	21	178	907	1.451
S020-23	23	178	949	1.537
S020-25	25	178	989	1.620
S020-27	27	178	1.027	1.703
S020-29	29	178	1.067	1.787
S020-31	31	278	1.172	1.904
S020-33	33	278	1.183	1.939
S020-35	35	278	1.223	2.020
S020-37	37	278	1.263	2.103
S020-39	39	278	1.304	2.185
S020-41	41	278	1.344	2.267
S020-43	43	278	1.384	2.349
S020-45	45	278	1.451	2.476
S020-47	47	278	1.492	2.559
S020-49	49	278	1.544	2.661
S020-51	51	478	1.649	2.754
S020-53	53	478	1.690	2.836
S020-55	55	478	1.731	2.920
S020-57	57	478	1.773	3.002
S020-59	59	478	1.815	3.085
S020-61	61	478	1.855	3.167
S020-63	63	478	1.897	3.250
S020-65	65	478	1.938	3.332
S020-67	67	478	1.980	3.415
S020-69	69	478	2.020	3.497
S020-71	71	478	2.062	3.580
S020-73	73	478	2.103	3.662
S020-75	75	478	2.145	3.746

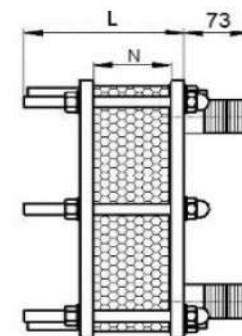
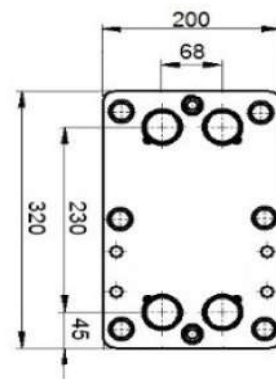

OPCIONALES

AISLAMIENTO FRÍO/CALOR

REFERENCIA	Nº MAX. PLACAS	P.V.P. (€)
AS-020-29	29	211
AS-020-49	49	253
AS-020-75	75	279

ANCLAJES

REFERENCIA	P.V.P. (€)
ANCLAJE SUELO	75
ANCLAJE PARED*	120

* Hasta 29 placas



CIPRIANI SCAMBIATORI ESPAÑA S.L.

Tel. Contacto 93.432.38.59

cipriani@cipriani.es

REFERENCIA	Nº PLACAS	LONGITUD (mm)	P.V.P. INOX (€)	P.V.P. TITANIO (€)
S040-05	5	178	672	860
S040-07	7	178	742	984
S040-09	9	178	819	1.120
S040-11	11	178	890	1.251
S040-13	13	178	942	1.353
S040-15	15	178	993	1.454
S040-17	17	178	1.044	1.556
S040-19	19	178	1.095	1.659
S040-21	21	178	1.270	1.930
S040-23	23	178	1.327	2.066
S040-25	25	178	1.383	2.179
S040-27	27	178	1.440	2.292
S040-29	29	178	1.496	2.405
S040-31	31	278	1.627	2.538
S040-33	33	278	1.696	2.669
S040-35	35	278	1.756	2.789
S040-37	37	278	1.815	2.898
S040-39	39	278	1.875	3.013
S040-41	41	278	1.933	3.127
S040-43	43	278	1.993	3.241
S040-45	45	278	2.131	3.484
S040-47	47	278	2.192	3.602
S040-49	49	278	2.281	3.767
S040-51	51	478	2.422	3.888
S040-53	53	478	2.485	4.006
S040-55	55	478	2.547	4.123
S040-57	57	478	2.609	4.232
S040-59	59	478	2.671	4.360
S040-61	61	478	2.733	4.478
S040-63	63	478	2.796	4.596
S040-65	65	478	2.858	4.714
S040-67	67	478	2.920	4.832
S040-69	69	478	2.982	4.951
S040-71	71	478	3.045	5.068
S040-73	73	478	3.108	5.186
S040-75	75	478	3.170	5.304

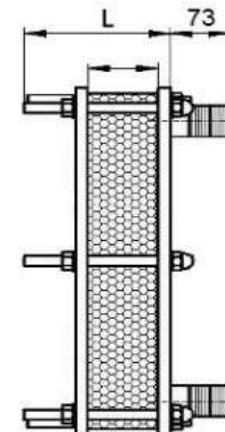
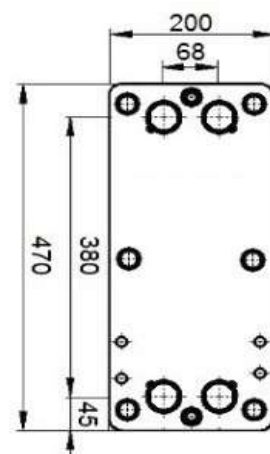

OPCIONALES

AISLAMIENTO FRÍO/CALOR

REFERENCIA	Nº MAX. PLACAS	P.V.P. (€)
AS-040-29	29	228
AS-040-49	49	259
AS-040-75	75	286

ANCLAJES

REFERENCIA	P.V.P. (€)
ANCLAJE SUELO	75
ANCLAJE PARED*	120

* Hasta 29 palcas

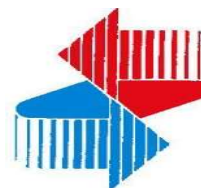

CIPRIANI SCAMBIATORI ESPAÑA S.L.

Tel. Contacto 93.432.38.59

cipriani@cipriani.es

REFERENCIA	Nº PLACAS	LONGITUD (mm)	P.V.P. INOX (€)	P.V.P. TITANIO (€)
S080-05	5	178	920	1.145
S080-07	7	178	1016	1.316
S080-09	9	178	1112	1.488
S080-11	11	178	1208	1.669
S080-13	13	178	1276	1.808
S080-15	15	178	1344	1.948
S080-17	17	178	1411	2.087
S080-19	19	178	1479	2.227
S080-21	21	178	1677	2.566
S080-23	23	178	1773	2.750
S080-25	25	178	1846	2.904
S080-27	27	178	1921	3.058
S080-29	29	178	1996	3.210
S080-31	31	278	2161	3.379
S080-33	33	278	2254	3.557
S080-35	35	278	2332	3.712
S080-37	37	278	2409	3.866
S080-39	39	278	2487	4.021
S080-41	41	278	2565	4.175
S080-43	43	278	2643	4.329
S080-45	45	278	2815	4.639
S080-47	47	278	2895	4.798
S080-49	49	278	3002	5.003
S080-51	51	478	3167	5.146
S080-53	53	478	3378	5.514
S080-55	55	478	3462	5.678
S080-57	57	478	3547	5.843
S080-59	59	478	3631	6.008
S080-61	61	478	3747	6.224
S080-63	63	478	3832	6.390
S080-65	65	478	3918	6.556
S080-67	67	478	4002	6.722
S080-69	69	478	4088	6.888
S080-71	71	478	4208	7.113
S080-73	73	478	4294	7.281
S080-75	75	478	4389	7.464

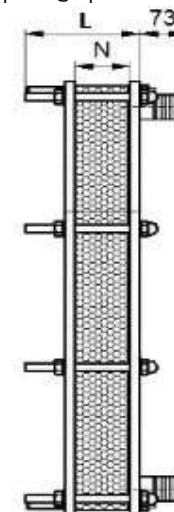
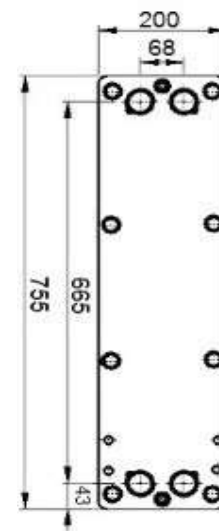

OPCIONALES

AISLAMIENTO FRÍO/CALOR

REFERENCIA	Nº MAX. PLACAS	P.V.P. (€)
AS-080-29	29	257
AS-080-49	49	268
AS-080-75	75	289

ANCLAJES

REFERENCIA	P.V.P. (€)
ANCLAJE SUELO	75
ANCLAJE PARED*	120

* Hasta 29 placas



CIPRIANI SCAMBIATORI ESPAÑA S.L.

Tel. Contacto 93.432.38.59

cipriani@cipriani.es

REFERENCIA	Nº PLACAS	LONGITUD (mm)	P.V.P. INOX (€)	P.V.P. TITANIO (€)
S070-05	5	320	1455	1573
S070-07	7	320	1554	1740
S070-09	9	320	1627	1881
S070-11	11	320	1721	2049
S070-13	13	320	1781	2178
S070-15	15	320	1842	2305
S070-17	17	320	1903	2434
S070-19	19	320	1964	2628
S070-21	21	320	2284	2921
S070-23	23	320	2370	3205
S070-25	25	320	2440	3350
S070-27	27	320	2509	3497
S070-29	29	320	2578	3643
S070-31	31	320	2646	3789
S070-33	33	320	2804	4063
S070-35	35	320	2875	4214
S070-37	37	320	2946	4365
S070-39	39	320	3017	4515
S070-41	41	320	3088	4609
S070-43	43	460	3109	4703
S070-45	45	460	3135	4797
S070-47	47	460	3158	4891
S070-49	49	460	3189	4984
S070-51	51	460	3256	5084
S070-53	53	460	3321	5224
S070-55	55	460	3388	5364
S070-57	57	460	3454	5504
S070-59	59	460	3520	5644
S070-61	61	460	3587	5784
S070-63	63	460	3653	5925
S070-65	65	460	3719	6066
S070-67	67	460	3786	6206
S070-69	69	460	3851	6346
S070-71	71	460	3918	6486
S070-73	73	600	4040	6675
S070-75	75	600	4384	6815

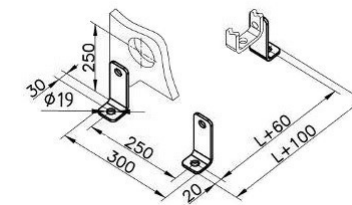
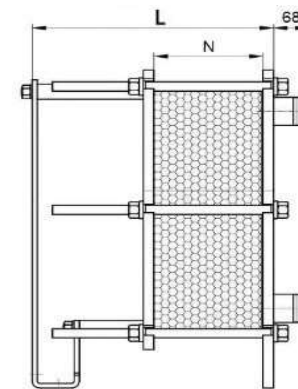
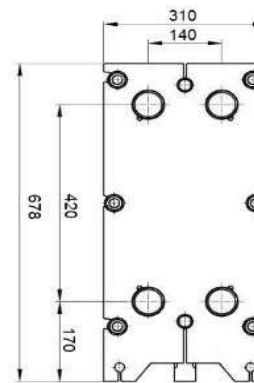

OPCIONALES

AISLAMIENTO FRÍO/CALOR			ANCLAJES	
REFERENCIA	Nº MAX. PLACAS	P.V.P. (€)	REFERENCIA	P.V.P. (€)
AS-070-41	41	336	ANCLAJE SUELO	45
AS-070-71	71	435		
AS-070-101	101	525		



CIPRIANI SCAMBIATORI ESPAÑA S.L.

Tel. Contacto 93.432.38.59

cipriani@cipriani.es

REFERENCIA	Nº PLACAS	LONGITUD (mm)	P.V.P. INOX (€)	P.V.P. TITANIO (€)
S160-05	5	320	1956	2.128
S160-07	7	320	2092	2.378
S160-09	9	320	2193	2.592
S160-11	11	320	2323	2.843
S160-13	13	320	2408	3.041
S160-15	15	320	2493	3.239
S160-17	17	320	2579	3.436
S160-19	19	320	2663	3.634
S160-21	21	320	3101	4.240
S160-23	23	320	3221	4.580
S160-25	25	320	3318	4.805
S160-27	27	320	3415	5.030
S160-29	29	320	3511	5.255
S160-31	31	320	3698	5.617
S160-33	33	320	3825	5.891
S160-35	35	320	3926	6.122
S160-37	37	320	4025	6.355
S160-39	39	320	4125	6.587
S160-41	41	320	4156	6.606
S160-43	43	460	4174	6.820
S160-45	45	460	4226	6.851
S160-47	47	460	4332	7.038
S160-49	49	460	4460	7.253
S160-51	51	460	4555	7.469
S160-53	53	460	4650	7.685
S160-55	55	460	4746	7.901
S160-57	57	460	4853	8.117
S160-59	59	460	4929	8.333
S160-61	61	460	4948	8.548
S160-63	63	460	5021	8.764
S160-65	65	460	5128	8.980
S160-67	67	460	5221	9.196
S160-69	69	460	5314	9.412
S160-71	71	460	5478	9.628
S160-73	73	600	5999	9.899
S160-75	75	600	6100	10.115

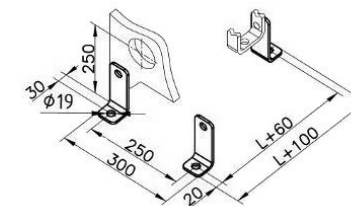
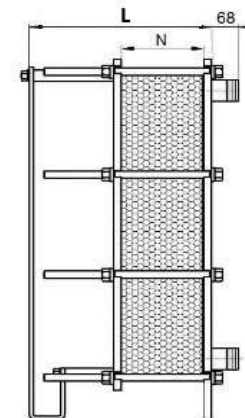
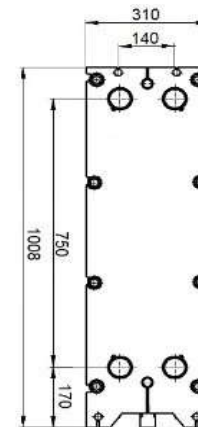

OPCIONALES

AISLAMIENTO FRÍO/CALOR

REFERENCIA	Nº MAX. PLACAS	P.V.P. (€)
AS-160-41	41	531
AS-160-71	71	557
AS-160-101	101	633

ANCLAJES

REFERENCIA	P.V.P. (€)
ANCLAJE SUELO	45



CIPRIANI SCAMBIATORI ESPAÑA S.L.

Tel. Contacto 93.432.38.59

cipriani@cipriani.es

REFERENCIA	Nº PLACAS	LONGITUD (mm)	P.V.P. INOX (€)	P.V.P. TITANIO (€)
S110-05	5	355	1813	2.042
S110-07	7	355	1935	2.255
S110-09	9	355	2025	2.435
S110-11	11	355	2141	2.649
S110-13	13	355	2217	2.811
S110-15	15	355	2293	2.974
S110-17	17	355	2367	3.138
S110-19	19	355	2443	3.385
S110-21	21	355	2842	3.761
S110-23	23	355	2948	4.123
S110-25	25	355	3034	4.309
S110-27	27	355	3120	4.494
S110-29	29	355	3206	4.680
S110-31	31	355	3292	4.866
S110-33	33	355	3487	5.216
S110-35	35	355	3575	5.407
S110-37	37	355	3665	5.599
S110-39	39	355	3753	5.790
S110-41	41	355	3841	5.909
S110-43	43	495	3938	6.090
S110-45	45	495	3970	6.207
S110-47	47	495	3998	6.326
S110-49	49	495	4035	6.443
S110-51	51	495	4118	6.570
S110-53	53	495	4199	6.747
S110-55	55	495	4282	6.926
S110-57	57	495	4364	7.103
S110-59	59	495	4447	7.282
S110-61	61	495	4528	7.460
S110-63	63	495	4610	7.638
S110-65	65	495	4693	7.816
S110-67	67	495	4775	7.995
S110-69	69	495	4857	8.172
S110-71	71	495	4939	8.351
S110-73	73	635	4989	8.655
S110-75	75	635	5412	8.833

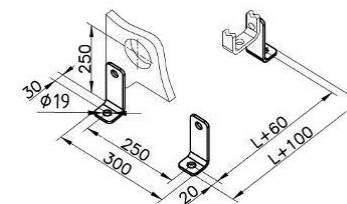
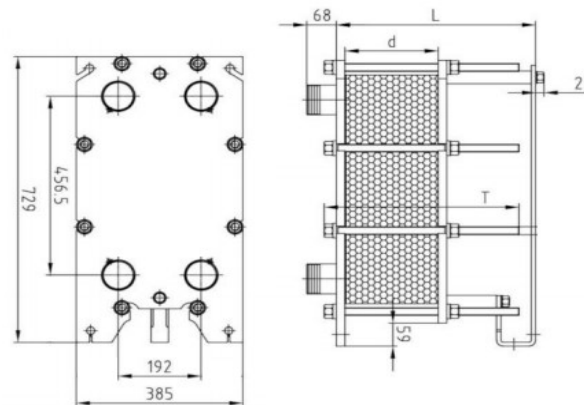

OPCIONALES

ASLAMIENTO FRÍO/CALOR

REFERENCIA	Nº MAX. PLACAS	P.V.P. (€)
AS-110-41	41	402
AS-110-71	71	503
AS-110-101	101	573

ANCLAJES

REFERENCIA	P.V.P. (€)
ANCLAJE SUELO	45



CIPRIANI SCAMBIATORI ESPAÑA S.L.

Tel. Contacto 93.432.38.59

cipriani@cipriani.es

REFERENCIA	Nº PLACAS	LONGITUD (mm)	P.V.P. INOX (€)	P.V.P. TITANIO (€)
S210-05	5	355	2476	2.736,86
S210-07	7	355	2637	3.027,27
S210-09	9	355	2755	3.271,35
S210-11	11	355	2909	3.560,63
S210-13	13	355	3005	3.783,24
S210-15	15	355	3102	4.004,72
S210-17	17	355	3199	4.227,33
S210-19	19	355	3296	4.562,94
S210-21	21	355	3827	5.070,31
S210-23	23	355	3966	5.562,99
S210-25	25	355	4077	5.816,11
S210-27	27	355	4187	6.068,10
S210-29	29	355	4297	6.321,22
S210-31	31	355	4407	6.573,21
S210-33	33	355	4665	7.048,94
S210-35	35	355	4779	7.309,97
S210-37	37	355	4893	7.569,87
S210-39	39	355	5006	7.830,90
S210-41	41	355	5120	7.993,62
S210-43	43	495	5231	8.225,27
S210-45	45	495	5269	8.386,86
S210-47	47	495	5302	8.547,32
S210-49	49	495	5349	8.708,91
S210-51	51	495	5455	8.880,67
S210-53	53	495	5561	9.123,62
S210-55	55	495	5667	9.366,57
S210-57	57	495	5772	9.608,39
S210-59	59	495	5878	9.851,34
S210-61	61	495	5983	10.093,16
S210-63	63	495	6090	10.336,11
S210-65	65	495	6196	10.577,93
S210-67	67	495	6301	10.820,88
S210-69	69	495	6407	11.063,83
S210-71	71	495	6512	11.305,65
S210-73	73	635	6797	11.704,54
S210-75	75	635	7371	11.947,49

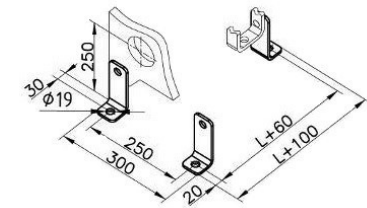
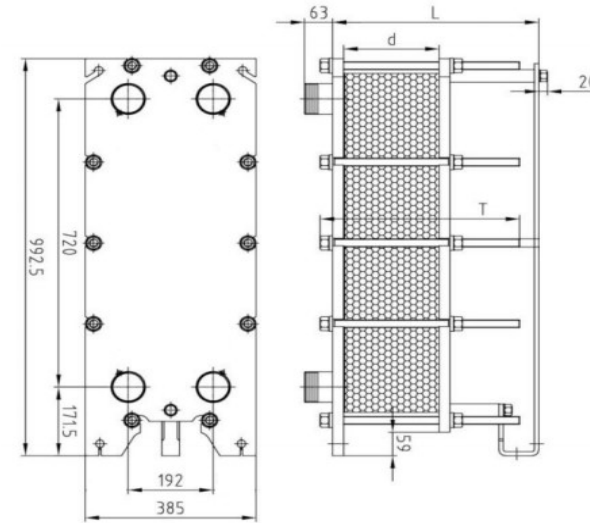

OPCIONALES

AISLAMIENTO FRÍO/CALOR

REFERENCIA	Nº MAX. PLACAS	P.V.P. (€)
AS-210-41	41	559
AS-210-71	71	606
AS-210-101	101	709

ANCLAJES

REFERENCIA	P.V.P. (€)
ANCLAJE SUELO	45



CIPRIANI SCAMBIATORI ESPAÑA S.L.

Tel. Contacto 93.432.38.59

cipriani@cipriani.es

REFERENCIA	Nº PLACAS	LONGITUD (mm)	P.V.P. INOX (€)	P.V.P. TITANIO (€)
S270-05	5	385	3048	3.182
S270-07	7	385	3136	3.407
S270-09	9	385	3224	3.632
S270-11	11	385	3312	3.856
S270-13	13	385	3400	4.080
S270-15	15	385	3488	4.304
S270-17	17	385	3576	4.529
S270-19	19	385	3665	4.665
S270-21	21	385	3753	4.885
S270-23	23	385	3841	5.008
S270-25	25	385	3929	5.224
S270-27	27	385	4017	5.440
S270-29	29	385	4105	5.656
S270-31	31	385	4193	5.871
S270-33	33	385	4282	6.088
S270-35	35	385	4370	6.304
S270-37	37	385	4458	6.520
S270-39	39	385	4546	6.736
S270-41	41	385	4634	6.952
S270-43	43	485	4761	6.992
S270-45	45	485	4849	7.203
S270-47	47	485	4937	7.412
S270-49	49	485	5025	7.622
S270-51	51	485	5113	7.832
S270-53	53	485	5201	8.041
S270-55	55	485	5290	8.251
S270-57	57	485	5378	8.460
S270-59	59	485	5466	8.670
S270-61	61	485	5554	8.881
S270-63	63	485	5642	9.090
S270-65	65	485	5731	9.300
S270-67	67	485	5820	9.509
S270-69	69	485	5908	9.719
S270-71	71	485	5996	9.929
S270-73	73	625	6033	10.187
S270-75	75	625	6118	10.397

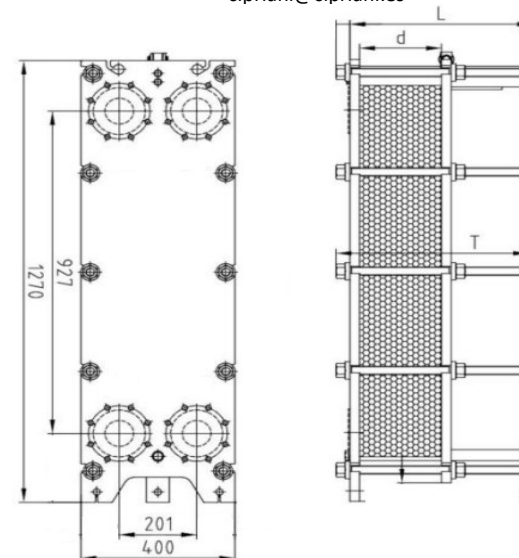

OPCIONALES

AISLAMIENTO FRÍO/CALOR

REFERENCIA	Nº MAX. PLACAS	P.V.P. (€)
AS-270-41	41	1156
AS-270-71	71	1156
AS-270-101	101	1454

* Anclaje a suelo - Incluido

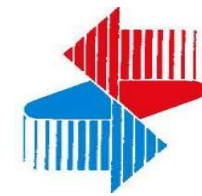

CIPRIANI SCAMBIATORI ESPAÑA S.L.

Tel. Contacto 93.432.38.59

cipriani@cipriani.es

REFERENCIA	Nº PLACAS	LONGITUD (mm)	P.V.P. INOX (€)	P.V.P. TITANIO (€)
S300-05	5	740	3546	3.932
S300-07	7	740	3636	4.236
S300-09	9	740	3727	4.541
S300-11	11	740	3817	4.845
S300-13	13	740	3909	5.151
S300-15	15	740	3999	5.455
S300-17	17	740	4089	5.760
S300-19	19	740	4180	6.064
S300-21	21	740	4270	6.369
S300-23	23	740	4362	6.673
S300-25	25	740	4452	6.977
S300-27	27	740	4543	7.282
S300-29	29	740	4633	7.586
S300-31	31	740	4725	7.891
S300-33	33	740	4815	8.195
S300-35	35	740	4905	8.500
S300-37	37	740	4996	8.804
S300-39	39	740	5086	9.109
S300-41	41	740	5178	9.413
S300-43	43	740	5268	9.718
S300-45	45	740	5358	10.022
S300-47	47	740	5449	10.327
S300-49	49	740	5539	10.631
S300-51	51	740	5631	10.638
S300-53	53	740	5721	10.934
S300-55	55	740	5812	11.230
S300-57	57	740	5902	11.526
S300-59	59	740	5992	11.822
S300-61	61	740	6084	12.118
S300-63	63	740	6174	12.414
S300-65	65	740	6265	12.710
S300-67	67	740	6355	13.007
S300-69	69	740	6446	13.303
S300-71	71	740	6537	13.600
S300-73	73	740	6626	13.896
S300-75	75	740	6718	14.192

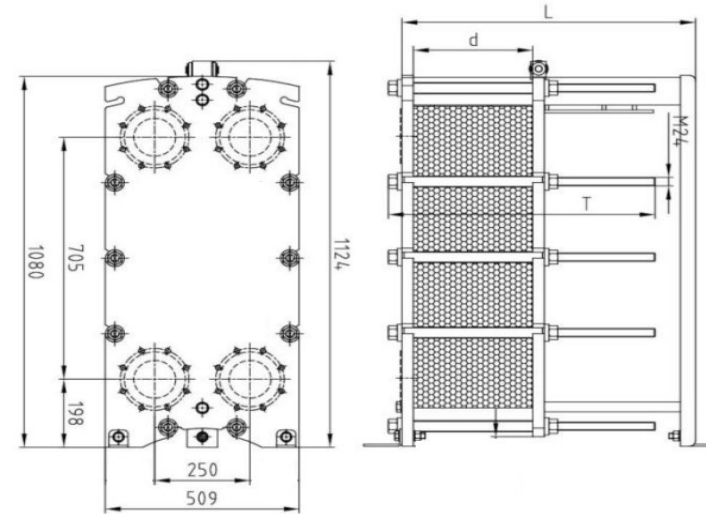

OPCIONALES

AISLAMIENTO FRÍO/CALOR

REFERENCIA	Nº MAX. PLACAS	P.V.P. (€)
AS-300-101	101	1991

* Anclaje a suelo - Incluido

SOLDADOS



CIPRIANI SCAMBIATORI ESPAÑA S.L.

Tel. Contacto 93.432.38.59
cipriani@cipriani.es

SERIE 2A14

MODELO	CONEXIONES	FONDO (mm)	PESO (kg)	P.V.P. (€)	P.V.P. AISLAMIENTO (€)
2A14-10	3/4" M	32	1,00	117	154
2A14-20	3/4" M	55	1,50	142	154
2A14-30	3/4" M	78	2,00	166	154
2A14-40	3/4" M	101	2,50	190	154

SERIE 2A22

MODELO	CONEXIONES	FONDO (mm)	PESO (kg)	P.V.P. (€)	P.V.P. AISLAMIENTO (€)
2A22-10	3/4" M	32	1,50	138	162
2A22-20	3/4" M	55	2,20	169	162
2A22-30	3/4" M	78	2,90	205	162
2A22-40	3/4" M	101	3,70	270	162
2A22-50	3/4" M	124	4,40	339	162

SERIE 2B31

MODELO	CONEXIONES	FONDO (mm)	PESO (kg)	P.V.P. (€)	P.V.P. AISLAMIENTO (€)
2B31-15	1-1/4" M	45	3,10	284	182
2B31-20	1-1/4" M	57	3,90	345	182
2B31-30	1-1/4" M	81	5,00	421	188
2B31-40	1-1/4" M	104	6,10	503	188
2B31-50	1-1/4" M	128	7,10	591	197
2B31-60	1-1/4" M	151	8,20	654	197

SERIE 2C110

MODELO	CONEXIONES	FONDO (mm)	PESO (kg)	P.V.P. (€)	P.V.P. AISLAMIENTO (€)
2C110-30	2" M	84	18,90	1.055	293
2C110-40	2" M	108	23,40	1.220	293
2C110-50	2" M	132	28,00	1.398	316

SERIE 2C170

MODELO	CONEXIONES	FONDO (mm)	PESO (kg)	P.V.P. (€)	P.V.P. AISLAMIENTO (€)
2C170-30	2" M	84	30,00	1.442	447
2C170-40	2" M	108	36,10	1.712	447
2C170-50	2" M	132	42,30	1.986	476

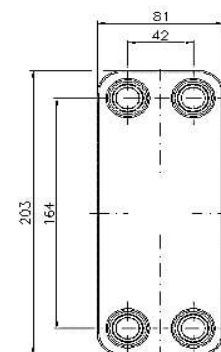

SERIE 2A14

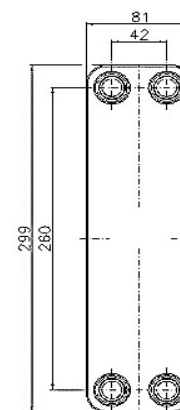

SERIE 2A22

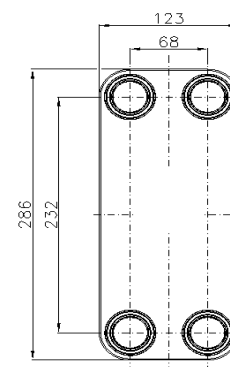

SERIE 2B31

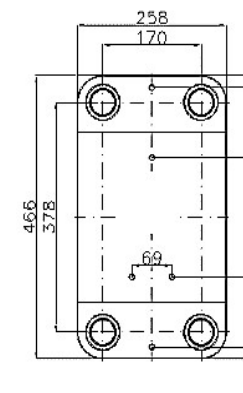

SERIE 2C110

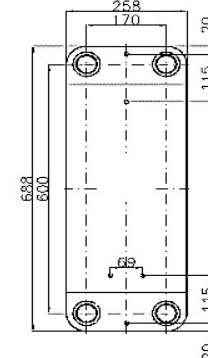

SERIE 2C170

TUBULARES



CIPRIANI SCAMBIATORI ESPAÑA S.L.

Tel. Contacto 93.432.38.59

cipriani@cipriani.es

INOXIDABLE (AGUA)								
MODELO	CONEXIONES		LONGITUD L (mm)	DIÁMETRO D (mm)	ANCHO TOTAL B (mm)	ENTRE EJES B (mm)	PESO (Kg)	P.V.P. (€)
	Entrada/salida 1°	Entrada/salida 2°						
T03	1"	1-1/2"	637	102	144	451	7,3	608
T05	1"	2"	1.103	102	144	884	12,4	894
T10	2"	2"	946	140	190	598	23,5	1.489

TITANIO (AGUA)								
MODELO	CONEXIONES		LONGITUD L (mm)	DIÁMETRO D (mm)	ANCHO TOTAL B (mm)	ENTRE EJES B (mm)	PESO (Kg)	P.V.P. (€)
	Entrada/salida 1°	Entrada/salida 2°						
TITS03	1-1/2"	1-1/2"	353	102	140	170	2,1	981
TITS05	1-1/2"	1-1/2"	453	102	140	270	2,7	1.096

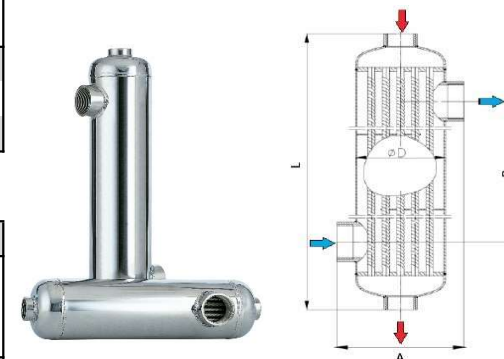

INOXIDABLE (VAPOR)											
MODELO	CONEXIONES		LONGITUD L (mm)	DIÁMETRO D (mm)	ANCHO TOTAL A (mm)	ENTRE EJES		PESO (Kg)	P.V.P. (€)	P.V.P. AISLAMIENTO (€)	P.V.P. ANCLAJES (€)
	Entrada/salida 1°	Entrada/salida 2°				B (mm)	C (mm)				
TV2FF	DN40	DN40	942	80	253	853	160	14,5	2.820	520,00	260,00
TV3FF	DN50	DN50	1.041	102	278	917	172	21,1	3.779	570,00	260,00
TV5FF	DN65	DN65	1.047	140	317	908	201	30,5	5.365	570,00	260,00
TV6FF	DN80	DN80	1.068	159	341	907	206	37,3	6.285	630,00	260,00
TF9FF	DN100	DN100	1.050	219	390	886	256	52,1	8.582	648,00	278,00

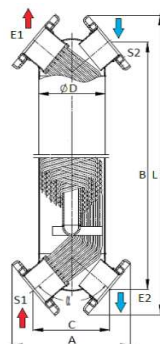

DESMONTABLES



CIPRIANI SCAMBIATORI ESPAÑA S.L.

Tel. Contacto 93.432.38.59

cipriani@cipriani.es

PROTECCIÓN PAQUETE PLACAS

PROTECCIÓN PAQUETE DE PLACAS P.V.P. (€)				
MODELO	HASTA 29 P	HASTA 49 P	HASTA 75 P	HASTA 101 P
S020+	188	208	228	-
S040+	195	220	244	-
S080+	212	228	249	296
MODELO	HASTA 41 P	HASTA 71 P	HASTA 101 P	HASTA 151 P
S070+	188	220	269	306
S160+	181	241	302	355
S110+	167	217	261	294
S210+	176	236	297	346
S270+	184	249	314	366

Protección del paquete de placas fabricada en acero inoxidable AISI304



BANDEJA DE CONDENSACIÓN

BANDEJA CONDENSACIÓN P.V.P. (€)				
MODELO	HASTA 29 P	HASTA 49 P	HASTA 75 P	HASTA 101 P
S020+	149	154	162	-
S040+	149	154	162	-
S080+	149	154	162	182
MODELO	HASTA 41 P	HASTA 71 P	HASTA 101 P	HASTA 151 P
S070+	173	184	193	202
S160+	173	184	193	202
S110+	173	189	193	207
S210+	173	189	193	207
S270+	173	189	193	207

Bandeja en Inox 304 con manguito de desagüe 3/4"



LIMPIEZA INTERCAMBIADORES

LIMPIEZA DE PLACAS POR RECIRCULACIÓN		
MODELO	APLICACIÓN	P.V.P. (€)
CIPRI DESIN 10	Limpieza ácida, contra cal, lodos y fangos. Apto para circuitos alimentarios.	54,00 (5 litros)
CIPRI NEUTREX	Neutralizador. Permite desaguar a la red los circuitos tratados con DESIN 10	30,00 (5 litros)

LIMPIEZA DE PLACAS POR RECIRCULACIÓN		
MODELO	APLICACIÓN	P.V.P. (€)
CIPRI DESENGRASANTE INOX10	Limpieza ácida contra grasas Apto para uso alimentario	42,00 (5 litros)
CIPRI INOX TITAN 10	Limpieza contra cal, lodos y fangos. Apto para Titanio	51,00 (5 litros)
CIPRI NEUTREX 10	Neutralizador. Permite desaguar a la red los circuitos tratados con INOX 10 e INOX TITAN 10	27,00 (5 litros)



ción sin dañar los diferentes materiales empleados (placas, juntas,...). Cada garrafa incluye instrucciones para su uso y aplicación



CIPRIANI SCAMBIATORI ESPAÑA S.L.

Tel. Contacto 93.432.38.59

cipriani@cipriani.es

*** Síguenos en nuestras RRSS:**



[ciprianiscambiatoriespana](https://www.instagram.com/ciprianiscambiatoriespana)