



**Catalogue**

**Catálogo**

**Catalog**



**2022**







El código QR le dará acceso a nuestros certificados  
 The QR code will give you access to our certificates  
 Avec le code QR vous aurez accès à nos certificats



Envases con colgador  
 Packing with a hanger  
 Emballages avec cintre



Dimension A-B-C

127 x 87 x 170
117 x 78 x 163
140 x 87 x 218
153 x 87 x 223
227 x 135 x 290

Medidas técnicas  
 Technical measures  
 Mesures techniques



Código de barras  
 Code bar  
 Codes-barres



Código de barras en las bolsas  
 Code bar in the bags  
 Codes-barres au des sacs



4 idiomas  
 4 languages  
 4 languages

Medidas técnicas

Las medidas técnicas (mm) se deben utilizar de modo orientativo  
 A. (Largo): la medida más larga del eje horizontal  
 B. (ancho): La medida más corta del eje horizontal  
 C. (alto): La medida del eje vertical  
 A max (Largo máximo): la medida más larga del eje horizontal máxima.  
 C max (Alto máximo): La medida del eje vertical máxima

Technical measures

Use these measure properly because there are guiding measure (mm)  
 A. (Large): The largest measure of the horizontal axis.  
 B. (wide): The shortest measure of the horizontal axis  
 C. (high): The vertical axis measure  
 A max (the largest): The largest of the horizontal axis  
 C max (The highest): The highest of the vertical axis.



Pag.	ESPAÑOL	INGLES	FRANCES	PORTUGUES
4	FILTRADO	FILTRATION	FILTRATION	FILTRO
8	ACCESORIOS PARA BIDONES Y CONVERSORES	TANK ACCESORIES AND CONVERTERS	ACCESOIRES POUR CUVES ET CONVERSEURS	ACESSORIOS PARA BIDOES E CONVERSORES
10	HERRAMIENTAS	TOOLS	OUTILS	FERRAMENTAS
12	ABONADO	FERTILIZATION	FERTILISATION	ABONADO
13	ARQUETAS	VALVE BOX	REGARD	CAIXA DE JARDIM
16	ELECTROVALVULAS	ELECTRIC VALVES	ELECTROVALVES	ELECTROVALVULAS
17	COLECTORES PARA ELECTROVALVULAS	THREADED CONNECTORS FOR ELECTRIC VLAVES	COLLECTEURS POUR ELECTROVANNES	COLECTORES PARA ELECTROVALVULAS
18	ASPERSION	ASPERSION	ASPERSION	ASPERSAO
20	MICROASPERSION	MICROSPRINKLER	MICROASPERSION	MICROASPERSAO
24	ACCESORIOS Y ESTACAS	ACCESSORIES AND STAKES	ACCESSOIRES ET ENJEUX	ACESSORIOS E PILHAS
25	VENTOSAS	AIR RELEASE VALVE	SOUPAPE DE DETENTE	VENTOSA
26	CONEXIONES HIDRAULICAS	HYDRAULIC CONNECTIONS	RACCORDS HYDRAULIC	CONEXOES HYDAULIC
29	UNION MICROTUBO ACETAL	MICROTUBE CONNECTOR ACETAL	RACCORD MICROTUBE ACETAL	UNIAO MICROTUBO ACETAL
30	UNION SIMPLE	SIMPLE UNION	RACCORD SIMPLE	UNIAO SIMPLES
32	UNION 4 PUNTAS	4 POINTED START UNION	RACCORD AVEC 4 POINTES	UNIAO 4 PONTAS ACETAL
33	ACOPLES	CONNECT	RACCORDER	ACOPLE
34	UNION ACETAL	ACETAL UNION	RACCORD EN ACETAL	UNIAO ACETAL
39	JUNTAS Y GOMAS	JOINTS	JOINTS	JOINTS
40	UNION SEGURIDAD	SAFETY UNION	RACCORD DE SECURITÉ	UNIAO SEGURANÇA
44	UNION COMPRESION	COMPRESSION UNION	RACCORD PAR COMPRESSION	UNIAO DE COMPRESSAO
45	UNION CINTA SUPERROSCADA	SUPER-THREADED TAPE UNION	RACCORD TUYAU PLAT SUPER-FILETÉ	UNIAO FITA SUPERROSCADA
47	UNION "Y" ACETAL	"Y" ACETAL UNION	RACCORD "Y" POUR TUYAU PLAT EN ACETAL	UNIAO DE FITA "Y" ACETAL
48	UNION CINTA EXTRA	EXTRA TAPE UNION	RACCORD TUYAU PLAT EXTRA	UNIAO FITA EXTRA
50	UNION CINTA ROSCADA	THREADED TAPE UNION	RACCORD POUR TUYAU PLAT FILETE	UNIAO FITA ROSCADA
51	UNION CINTA MEGAROSCADA	MEGA-THREADED TAPE UNION	RACCORD POUR TUYAU PLAT MEGA-FILETÉ	UNIAO FITA MEGA-ROSCADA
52	UNION LAYFLAT	LAYFLAT UNION	RACCORD LAYFLAT	UNIAO LAYFLAT
56	LLAVES TOTAL	TOTAL VALVES	VANNES TOTALE	VALVULA TOTAL
59	LLAVES CLIPADAS	PRESSED VALVES	VANNES PRESSEES	VALVULAS PRESIONADAS
61	LLAVES EXTRA	EXTRA VALVES	VANNES EXTRA	VALVULAS EXTRA
64	TAPONES	PLUGS	BOUCHONS	TACOS
66	GOTEROS	DRIPPERS	GOUTTEURS	GOTEJADORS
69	ACCESORIOS PARA HIDROPONICO	HYDROPHONICS ACCESORIES	ACCESOIRES POUR HYDRAPONIQUE	ACESSORIOS HIDROPONIA
70	SUJECIONES	FASTENING DEVICES	FIXATIONS	FIXACOES
72	COLLARINES	SADDLE CLAMP	COLLIER DE PRISE	TOMADA DE CARGA
74	UNION PVC	PVC UNION	RACCORD PVC	UNIAO PVC
75	VALVULAS PVC	PVC VALVES	VANNES PVC	VALVULAS PVC
76	UNION FITTING PE	FITTING FOR PE	RACCORD COMPRESSION POUR PVC	ACESSORIOS FITTING PE
82	ROSCADOS	THREADED	FILETÉS	ACESSORIOS ROSCADOS
86	SUMIDEROS Y CALDERETAS	DRAIN FLOORES	SIPHONS	SUMIDOUROS E CAIXAS SIFONICAS
88	VALVULA DESAGUE	DRAIN VALVE	VANNE D'EGOUT	VALVULAS DE SAIDA
90	SIFONES	SIPHONES	SIPHONS	SIFOES
92	SIFONES DOBLES	DOUBLE SIPHON	SIPHON DOUBLE	SIFOES DUPLOS
94	VALVULA DESAGUE CON REBOSADERO	DRAIN VALVES WITH SINK WASTE OUTLET	VANNE D'EGOUT AVEC DEVERSOIR	VALVULAS BASE CHUVEIRO
95	COMPLEMENTOS	COMPLEMENTS	COMPLEMENTS	COMPLEMENTOS
96	REPUESTOS	REPLACEMENTS	REPLACEMENTS	ACESSORIOS DE REPOSICAO







# ACCESORIOS DE RIEGO

## IRRIGATION ACCESSOIRES

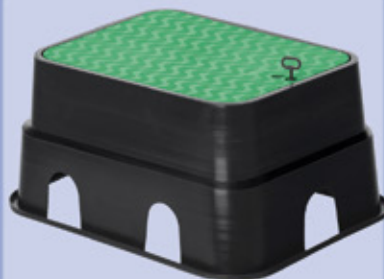

ACCESSOIRES POUR L'IRRIGATION

ACCESORIOS DE REGO

IRRIGATION  
RIEGO

- 8 435277 902108
- 8 435277 902115
- 8 435277 902122
- 8 435277 902139
- 8 435277 902146
- 8 435277 902207
- 8 435277 902214
- 8 435277 902221
- 8 435277 902238
- 8 435277 902245
- 8 435277 902818
- 8 435277 902825
- 8 435277 902917
- 8 435277 902924
- 8 435277 902948
- 8 435277 902955
- 8 435277 902825
- 8 435277 902849

**FILTRO DE ANILLA  
DISC FILTER  
FILTRE A DISQUES  
FILTRO DE ANILHA**

Ref.	Ø (" - MESH)		€	Dimensiones A-B-C
0210	2 - 120	- 2	195,7498	273x212x419
0211	2 Super - 120	- 1	286,4576	268x213x552
0212	3 - 120	- 1	286,4576	268x213x552
0220	2 - 140	- 2	195,7498	273x212x419
0221	2 Super - 140	- 1	286,4576	268x213x552
0220	3 - 140	- 1	286,4576	268x213x552

**FILTRO DE ANILLA MEGA  
MEGA DISC FILTER  
FILTRE A DISQUES MEGA  
FILTRO DE ANILHA MEGA**

Ref.	Ø (" - MESH)		€	Dimensiones A-B-C
0281	2 - 120	- 2	324,5000	
0282	3 - 120	- 2	324,5000	
0291	2 - 140	- 2	324,5000	
0292	3 - 140	- 2	324,5000	
A 0295	2 - 140 (NPT)	- 2	225,5000	
A 0297	3 - 140 (NPT)	- 2	324,5000	

\*Los articulos NPT se fabricarán bajo pedido

**RECAMBIO FILTRO DE ANILLA  
DISC CARTRIDGE  
CARTOUCHE DU FILTRE A DISQUES  
RECARGA FILTRO DE ANILHA**

Ref.	Ø (" - MESH)		€	Dimensiones A-B-C
0213	2 - 120	- 2	97,8806	151x151x324
0214	2 Super y 3 - 120	- 2	143,2288	151x151x468
0223	2 - 140	- 2	97,8806	151x151x324
0224	2 Super y 3 - 140	- 2	143,2288	151x151x468

**RECAMBIO FILTRO DE ANILLA MEGA  
MEGA DISC CARTRIDGE  
CARTOUCHE DU FILTRE A DISQUES MEGA  
RECARGA FILTRO DE ANILHA MEGA**

Ref.	Ø (" - MESH)		€	Dimensiones A-B-C
0284	2 y 3 - 120	- 2	162,2500	
0294	2 y 3 - 140	- 2	162,2500	





Tuerca de polipropileno ajustada para montar y desmontar con facilidad. SIN INCOMODAS abrazaderas de metal.

Roscas de inyección. No torneado manual.

Adjusted polyethylene threaded connector for easy setting and removing.

Injection threaded connctors. No manually turned. WITH NO AWKWARD metal braces.

Salida desagte para limpieza de filtro.

Drainage exit to clean the filter.



Sistema DOBLE ROSCA Permite limpiar las anillas sin desmontar el cartucho.

DOUBLE THREAD System which allows you to clean the rings without removing the cartridge.



Diseño especial para obtener mayor rendimiento de filtrado y RETENER mayor cantidad de suciedad con mínimo gasto energético.

Special design to obtain better filtering performance and retain more dirty with minimal energy waste.



Llave apretar fitting de utilidad en filtros

Torque wrench to tightening fitting Filters utility example



Ejemplo Ver apartado de herramientas

See tools section.

Equipado con 2 juntas toricas para mayor estanqueidad de la suciedad en su malla de acero INOX. Maxima estanqueidad reforzado con junta torica encajada en el tapon de cierre.

Equipped with 2 O-Rings to keep more dirty in the INOX steel screen. Highest stagnancy, reinforced with a fixed O-Ring on the screw top.



Pérdida de carga filtro de anilla de 140 Mesh de 2". Ref: 2163

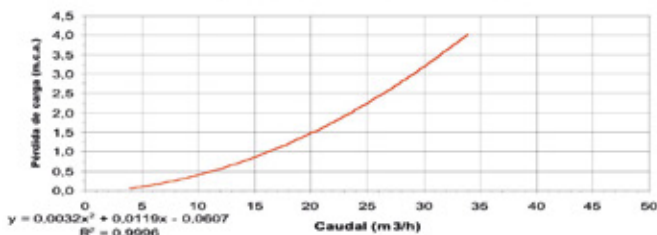

Pérdida de carga filtro de anilla de 140 Mesh de 3". Ref: 2190

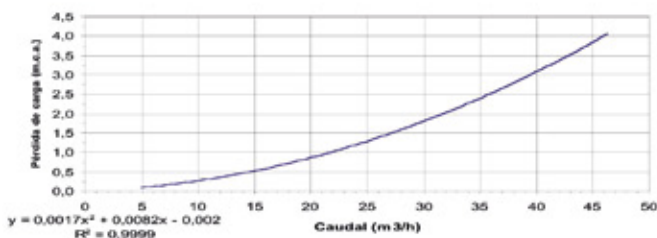

**AMPLIACIÓN  
NEW MEASURES**

 DISPONIBLE  
AVAILABLE **NPT**
**FILTRO DE ANILLA EN LINEA 120 MESH  
DISC FILTER 120 MESH**
**FILTRE A DISQUES 120 MESH  
FILTRO DE ANILHA LIMHA 120 MESH**

Ref.	Ø (")			€	Dimensiones A-B-C
<b>0262</b>	1	-	1	<b>18,0136</b>	140x87x218
<b>A 0264</b>	1 1/2	-	1	<b>38,0000</b>	227x135x290
<b>0265</b>	2	-	1	<b>49,1832</b>	235x134x343
<b>A 0269</b>	1 1/2 (NPT)	-	1	<b>38,0000</b>	227x135x290
<b>A 0268</b>	2 (NPT)	-	1	<b>49,1832</b>	235x134x343

\*Los articulos NPT se fabricarán bajo pedido

**FILTRO INTERLINEA  
IN LINE FILTER  
FILTRE CANNELE  
FILTRO INTERLINHA**

Ref.	Ø (")			€	Dimensiones A-B-C
<b>0271</b>	16 mm	-	50	<b>4,1800</b>	
<b>0272</b>	20 mm	-	50	<b>4,1800</b>	
<b>0274</b>	16 mm	-	50	<b>4,1800</b>	
<b>0276</b>	1/2"	-	50	<b>4,1800</b>	

**AMPLIACIÓN  
NEW MEASURES**

**RECAMBIO FILTRO ANILLA EN LINEA 120 MESH  
DISC CARTRIDGE 120 MESH  
CARTOUCHE FILTRE A DISQUES 120 MESH  
RECARGA FILTRO ANILHA 120 MESH**

Ref.	Ø (")			€	Dimensiones A-B-C
<b>0266</b>	1	-	1	<b>9,0068</b>	
<b>A 0263</b>	1 1/2	-	1	<b>17,2141</b>	
<b>0267</b>	2	-	1	<b>24,5916</b>	



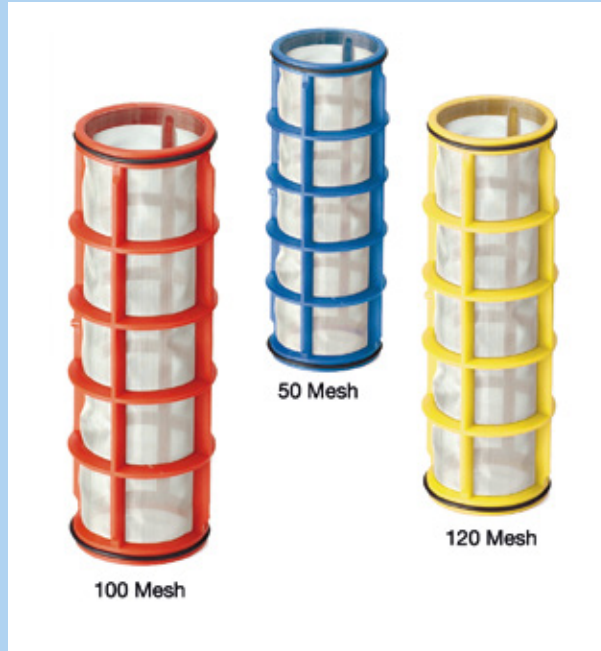

**FILTRO MALLA (50 MESH)**  
**SCREEN FILTER (50 MESH)**  
**FILTRE A TAMIS (50 MESH)**  
**FILTRO DE MALHA (50 MESH)**

Ref.	Ø (")		€	Dimensiones A-B-C
0230	1/2	- 20	13,6032	127x87x170
0231	3/4	- 20	13,6032	117x78x163
0232	1	- 20	14,8512	140x87x218
0233	1 1/4	- 20	19,9805	153x87x223
0234	1 1/2	- 10	25,5341	227x135x290
0235	2	- 10	44,0544	235x134x343

**RECAMBIO FILTRO MALLA (50 MESH)**  
**SCREEN FILTER CARTRIDGE (50 MESH)**  
**CARTOUCHE FILTRE A TAMIS (50 MESH)**  
**RECARGA FILTRO MALHA (50 MESH)**

Ref.	Ø (")		€	Dimensiones A-B-C
0236	1/2 - 3/4	- 20	6,6893	52x52x126
0237	1 - 1 1/4	- 20	9,9965	52x52x166
0238	1 1/2	- 10	12,7670	85x85x179
0239	2	- 10	22,0272	85x85x228

**FILTRO MALLA (100 MESH)**  
**SCREEN FILTER (100 MESH)**  
**FILTRE A TAMIS (100 MESH)**  
**FILTRO DE MALHA (100 MESH)**

Ref.	Ø (")		€	Dimensiones A-B-C
0240	1/2	- 20	13,6032	127x87x170
0241	3/4	- 20	13,6032	117x78x163
0242	1	- 20	14,8512	140x87x218
0243	1 1/4	- 20	19,9805	153x87x223
0244	1 1/2	- 10	25,5341	227x135x290
0245	2	- 10	44,0544	235x134x343

**RECAMBIO FILTRO MALLA (50 MESH)**  
**SCREEN FILTER CARTRIDGE (50 MESH)**  
**CARTOUCHE FILTRE A TAMIS (50 MESH)**  
**RECARGA FILTRO MALHA (50 MESH)**

Ref.	Ø (")		€	Dimensiones A-B-C
0246	1/2 - 3/4	- 20	6,6893	52x52x126
0247	1 - 1 1/4	- 20	9,9965	52x52x166
0248	1 1/2	- 10	12,7670	85x85x179
0249	2	- 10	22,0272	85x85x228

**FILTRO MALLA (120 MESH)**  
**SCREEN FILTER (120 MESH)**  
**FILTRE A TAMIS (120 MESH)**  
**FILTRO DE MALHA (120 MESH)**

Ref.	Ø (")		€	Dimensiones A-B-C
0250	1/2	- 20	13,6032	127x87x170
0251	3/4	- 20	13,6032	117x78x163
0252	1	- 20	14,8512	140x87x218
0253	1 1/4	- 20	19,9805	153x87x223
0254	1 1/2	- 10	25,5341	227x135x290
0255	2	- 10	44,0544	235x134x343

**RECAMBIO FILTRO MALLA (50 MESH)**  
**SCREEN FILTER CARTRIDGE (50 MESH)**  
**CARTOUCHE FILTRE A TAMIS (50 MESH)**  
**RECARGA FILTRO MALHA (50 MESH)**

Ref.	Ø (")		€	Dimensiones A-B-C
0256	1/2 - 3/4	- 20	6,6893	52x52x126
0257	1 - 1 1/4	- 20	9,9965	52x52x166
0258	1 1/2	- 10	12,7670	85x85x179
0259	2	- 10	22,0272	85x85x228



8 435277 906250



8 435277 906267



8 435277 906335



8 435277 906342



8 435277 906359



**ADAPTADOR UNIVERSAL BIDONES**  
**UNIVERSAL TANK ADAPTER**  
**ADAPTATEUR UNIVERSEL POUR CUVES-**  
**ADAPTADOR UNIV CUVES**

Ref.	Ø (")			€	Dimensiones A-B-C
0625	1 1/2	1	20	15,4440	61x76x76
0626	2	1	20	15,4440	61x76x76



**ADAPTADOR UNIVERSAL BIDONES MACHO**  
**UNIVERSAL TANK ADAPTER MALE**  
**ADAPTATEUR UNIVERSEL POUR CUVES**  
**ADAPTADOR MACHO UNIV. BIDAO**

Ref.	Ø (")			€	Dimensiones A-B-C
0634	3/4	1	50	7,0928	53x69x69
0633	1	1	50	7,0928	53x69x69
0635	1 1/2	1	50	7,0928	53x69x69





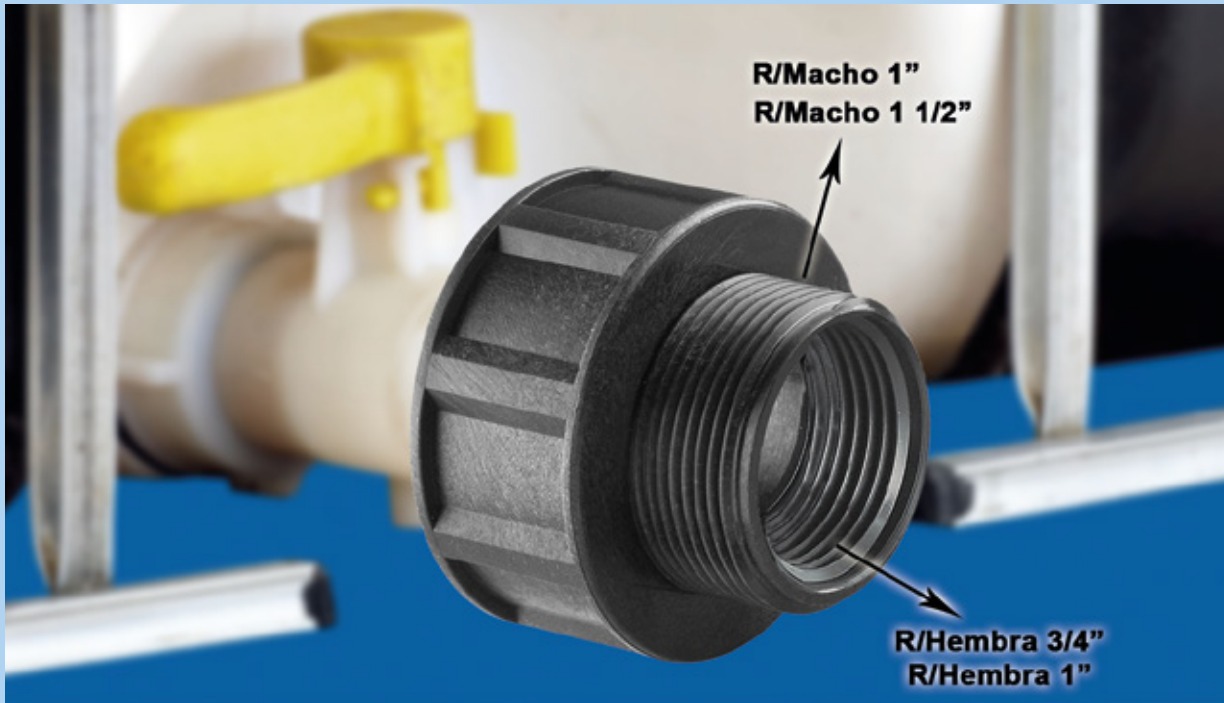

**ADAPTADOR UNIVERSAL BIDONES MACHO - HEMBRA**  
**UNIVERSAL TANK ADAPTER MALE - FEMALE**

**ADAPTATEUR UNIVERSEL POUR CUVES**  
**ADAPTADOR MACHO-HEMBRA UNIV. BIDAO**

Ref.	Ø (")			€	Dimensiones A-B-C
0632	1 - 3/4	1	50	8,2500	53x69x69
0631	1 1/2 - 1	1	50	8,9100	53x69x69
0600	Junta Adaptador	-	-	6,8900	Estándar



**CONVERTIDOR BSP-NPT**  
**CONVERTER BSP-NPT**  
**CONVERTISSEUR BSP-NPT**  
**CONVERSOR BSP-NPT**

Ref.	Ø (")			€	Dimensiones A-B-C
0646	2	-	100	8,1796	61x76x76
0647	2 1/2	-	20	22,4923	98x95x95
0648	3	-	10	23,7838	113x111x111



**PASAMUROS SIMPLE**  
**TANK CONNECTOR**  
**TRAVERS-PAROI**  
**PASSA-MUROS SIMPLE**

Ref.	Ø (mm - ")			€	Dimensiones A-B-C
0611	20 - 1/2	1	100	3,3748	52x46x46
0612	25 - 3/4	1	100	3,5350	60x52x52
0613	32 - 1	1	100	4,9535	72x59x59
0614	40 - 1 1/4	1	50	7,4246	77x61x61
0615	50 - 1 1/2	1	40	9,8842	87x65x65
0616	63 - 2	1	30	12,6755	97x77x77



**SACA-BOCADO EXPULSOR SENCILLO  
PUNCH WITH EJECTOR**

EMPOTRE-PIECES SIMPLE AVEC EJEC TEUR  
PERFORADOR C/EXPULSAO SIMPLE

Ref.	Ø (mm)			€	Dimensiones A-B-C
0510	2,6	-	50	6,7642	
0511	3	-	50	6,7642	
0512	4	-	50	6,7642	
0513	7	-	50	6,7642	
0514	9	-	50	6,7642	



**SACA-BOCADO EXPULSOR PROFESIONAL  
PROFESIONAL PUNCH WITH EJECTOR**

EMPOTRE-PIECES PROFESSIONNEL AVEC EJEC TEUR  
PERFORADOR C/EXPULSAO PROF

Ref.	Ø (mm)			€	Dimensiones A-B-C
0520	2,6	-	50	9,6845	
0521	3	-	50	9,6845	
0522	4	-	50	9,6845	
0523	7	-	50	9,6845	
0524	9	-	50	9,6845	



**SACA-BOCADO CON ADAPTADORES  
PUNCHER WITH ADAPTERS**

EMPOTRE-PIECES AVEC ADAPTATEURS  
PERFORADOR COM ADAPTADO

Ref.	Ø (mm)			€	Dimensiones A-B-C
0571	3	1	50	13,2000	
0573	7	1	50	13,2000	



**PERFORADOR PISTOLA EXP. AUTOMATICO  
PUNCH WITH AUTOMATIC EJECTOR**

EMPOTRE-PIECES PISTOLET AUTO-EJEC TEUR  
ALICATE FURADOR

Ref.	Ø (mm)			€	Dimensiones A-B-C
0530	3	1	10	32,0362	
0531	4	1	10	32,0362	





**LLAVE APRETAR FITTING  
WRENCH FOR FASTENING FITTING  
CLE DE SERRAGE  
CHAVE APERTO**

**LLAVE APRETAR  
WRENCH FOR FASTENING  
CLE DE SERRAGE  
CHAVE APERTO**

Ref.	Ø (")		€	Dimensiones A-B-C
0550	20 - 25 - 32	- 100	2,7799	235x12x67
0551	40 - 50 - 63	- 30	4,5302	279x14x67
0552	75 - 90 - 110	- 10	13,0832	494x15x161

Ref.	Ø (")		€	Dimensiones A-B-C
0560	20-25-32-40	- 100	2,5282	
0561	50-63	- 30	4,1184	
0540	Punzón y Gotero	- 500	0,8008	



**Utilidades del perforador para:**  
Goteros.  
Tomas.  
Colarines

**Punch use for:**  
Drippers  
Intakes  
Saddle





Caudalímetro: su graduación es perfecta y totalmente fiable. La bola indicadora de caudal es de acero inoxidable (AISI 304) para evitar oxidaciones por los fertilizantes.

Flowmeter: perfect and totally reliable pre-setting with a ball meter made of steel to prevent oxidation by the fertilizer (AISI 304).



Se sirve en un estuche con accesorios excepto manguera  
Available in a pack with the accessories.  
Tube not available



Llave dosificadora: sirve para aumentar o disminuir la dosis de fertilizante que queremos insertar en la instalación. También sirve de válvula antiretorno cuando la cerramos.

Adjustable valve: increases or decreases the fertilizer dose that we want to insert in the installation. Also, it works as a check valve when we close it.



**Inyector King**

Valvula de retención que evita que los fluidos vuelvan al depósito. Incorpora un filtro para evitar obstrucciones por los sedimentos en suspensión.

Return valve that prevents fluid back to the reservoir. It incorporates a filter to avoid obstructions by suspended sediments.

Datos técnicos orientativos obtenidos en nuestros laboratorios por técnicos cualificados

Technical orientative details obtained from our qualified technical laboratories

Modelo registrado en la propiedad industrial / Patent rights of this model is registered



## INYECTOR FERTILIZANTE FERTILIZER INJECTOR INJECTEUR D'ENGRAIS INYECTOR FERTILIZANTE

Ref.	Ø (") - Paso (mm)	Paquete	€	Dimensiones A-B-C
0110	3/4 - 3	1 10	55,8250	156x40x143
0111	3/4 - 5	1 10	55,8250	156x40x143
0112	1 - 7	1 10	55,8250	156x40x143
0113	1 - 9	1 10	55,8250	156x40x143
0114	1 1/2	1 6	104,5000	275x55x120
0115	2	1 6	104,5000	295x60x150
0102	Valvula Retención	- -	11,0000	
0101	Caudalímetro con bola Inox	- -	9,0000	

\*0114 y 0115 sin caudalímetro ni válvula de retención

\*0114 y 0115 with out flowmeter and return valve

\*0114 & 0115 sans débitmètre ni soupape antiretour

entrada Atm	salida Atm	pérdida carga	Inyector 3mm 3/4 Caudal absorción
0,9	0,2	0,7	2040 l/h 20,4 l/h
1,0	0,3	0,7	2160 l/h 20,2 l/h
1,0	0,1	0,9	2160 l/h 42,8 l/h
1,4	0,4	1,0	2520 l/h 51,4 l/h
1,6	0,8	0,8	2760 l/h 14,0 l/h
1,6	0,4	1,2	2760 l/h 48,6 l/h
1,9	1,0	0,9	3060 l/h 26,0 l/h
1,9	0,5	1,4	3120 l/h 38,2 l/h
2,4	0,4	2,0	2820 l/h 31,0 l/h
2,4	1,3	1,1	2820 l/h 15,5 l/h

entrada Atm	salida Atm	pérdida carga	Inyector 5mm 3/4 Caudal absorción
0,5	0,1	0,4	2280 l/h 36 l/h
0,8	0,3	0,5	2520 l/h 38 l/h
1,1	0,5	0,6	2940 l/h 49 l/h
1,5	0,8	0,7	3360 l/h 78 l/h
1,8	1,0	0,8	3780 l/h 90 l/h
2,0	1,2	0,8	4020 l/h 100 l/h
2,4	1,5	0,9	4380 l/h 120 l/h
2,7	1,6	1,1	4680 l/h 125 l/h
2,9	1,8	1,1	4860 l/h 130 l/h
3,1	2,0	1,1	4980 l/h 150 l/h

entrada Atm	salida Atm	pérdida carga	Inyector 7mm 1" Caudal absorción
0,6	0,2	0,4	1620 l/h 33,9 l/h
0,5	0,0	0,5	1800 l/h 150 l/h
0,9	0,5	0,4	1980 l/h 54 l/h
0,9	0,1	0,8	2160 l/h 200 l/h
1,3	0,8	0,5	2280 l/h 78,2 l/h
1,3	0,2	1,1	2460 l/h 225 l/h
1,7	1,1	0,6	2520 l/h 120 l/h
1,7	0,5	1,2	2760 l/h 300 l/h
2,0	1,5	0,5	2820 l/h 40,9 l/h
2,0	0,8	1,2	3120 l/h 257 l/h

entrada Atm	salida Atm	pérdida carga	Inyector 9mm 1" Caudal absorción
0,6	0,1	0,5	1860 l/h 10,4 l/h
1,7	0,3	0,8	2460 l/h 85,7 l/h
1,4	0,5	0,9	2760 l/h 100 l/h
1,6	0,8	0,8	3060 l/h 128 l/h
2,0	0,9	1,1	3360 l/h 150 l/h
2,3	1,1	1,2	3840 l/h 150 l/h
2,6	1,3	1,3	4080 l/h 180 l/h
2,8	1,5	1,3	4270 l/h 200 l/h
3,3	1,6	1,7	4500 l/h 200 l/h
3,5	1,6	1,9	4620 l/h 225 l/h
3,7	1,9	1,8	4740 l/h 257 l/h





**ARQUETA CIRCULAR CON CONEXIÓN**  
**ROUND VALVE BOX WITH CONNECTION**  
**REGARD CYLINDRIQUE A RACCORDMENT**  
**TAMPA CAIXA CONEXAO**

**ARQUETA CIRCULAR CON CONEXIÓN**  
**ROUND VALVE BOX WITH CONNECTION**  
**REGARD CYLINDRIQUE A RACCORDMENT**  
**TAMPA CAIXA CONEXAO**

Ref.	Ø (")		€	Dimensiones A-B-C
0316	Llave - 3/4	- 16	10,9890	210x150

Ref.	Ø (")		€	Dimensiones A-B-C
0317	Valvula PVC macho	- 16	15,3890	210x150



**ARQUETA CIRCULAR CON CONEXIÓN**  
**ROUND VALVE BOX WITH CONNECTION**  
**REGARD CYLINDRIQUE A RACCORDMENT**  
**TAMPA CAIXA CONEXAO**

**VALVULA HIDRANTE**  
**CONEXION VALVE**  
**CLAPETS**  
**VALVULA HIDRANTE**

Ref.	Ø (")		€	Dimensiones A-B-C
0318	Valvula Hidrante 3/4	- 16	17,5890	210x150

Ref.	Ø (")		€	Dimensiones A-B-C
2641	3/4	- 50	8,2500	
2642	1	- 50	8,9100	
2643	Llave 3/4	- 50	5,2800	



**ARQUETA CIRCULAR  
ROUND VALVE BOX  
REGARD CYLINDRIQUE  
TAMPA CAIXA REDONDA**

**ARQUETA CIRCULAR GRANDE  
BIG ROUND VALVE BOX  
GRAND REGARD CYLINDRIQUE  
TAMPA CAIXA REDONDA GRANDE**

Ref.	Ø (")			€	Dimensiones A-B-C
0310	-	-	30	6,3250	200x143
0319	-	-	24	7,5900	225x143

Ref.	Ø (")			€	Dimensiones A-B-C
0314	-	-	8	8,7120	285x250



**Facil de empotrar ya que la tapadera se aloja en su interior**  
Easy to fit in because the lid is the interior



**Incorpora un cierre anti-vandálico que impide la manipulación no deseada en su interior. Incluye una llave allen de plástico**



Made of polyethylene of the highest endurance.

Fabricado en polipropileno de la más alta resistencia



**Máxima superficie antideslizante con un diseño vanguardista**  
Highest Anti-Slipping surface with an avant-garde layout.







**ARQUETA PEQUEÑA**  
**SMALL VALVE BOX**  
**PETIT REGARD RECTANGULAIRE**  
**CX ELECTROVALVULA**

**ARQUETA GRANDE**  
**BIG VALVE BOX**  
**GRAND REGARD**  
**CX ELECTROVALVULA**

Ref.	Ø (")		€	Dimensiones A-B-C
0311	-	- 15	10,5362	240x270x175

Ref.	Ø (")		€	Dimensiones A-B-C
0312	-	- 10	21,0267	420x320x200



**ARQUETA EXTRAGRANDE**  
**KING VALVE BOX**  
**EXTRAGRAND REGARD**  
**TAMPA CAIXA EXTRAGRANDE**

**ARQUETA SUPERGRANDE**  
**JUMBO VALVE BOX**  
**EXTRA GRAND REGARD**  
**CX EVAVALVULA**

Ref.	Ø (")		€	Dimensiones A-B-C
0315	-	- 6	26,6200	520x420x260

Ref.	Ø (")		€	Dimensiones A-B-C
0313	-	- 5	57,4059	650x530x300

- 8 435277 925107
- 8 435277 925114
- 8 435277 925121
- 8 435277 925138
- 8 435277 925145
- 8 435277 925152
- 8 435277 925190
- 8 435277 925206
- 8 435277 925213
- 8 435277 925220
- 8 435277 925237
- 8 435277 925244
- 8 435277 925251



**ELECTROVALVULA 24V AC**  
**ELECTRIC VALVE 24V. AC**  
**ELECTROVANNE 24V. AC**  
**ELECTROVÁLVULA 24V 1**

Ref.	Ø (")			€	Dimensiones A-B-C
2511	1	-	15	35,6304	
2512	1 C/Reg	-	15	39,7488	
2513	1 1/2 C/Reg	-	10	67,2048	
2514	2 C/Reg	-	2	122,1168	
2515	3 C/Reg Macho	-	2	150,9456	
2510	24v AC	-	-	19,2000	
2519	Adaptador	-	-	2,8800	



**ELECTROVALVULA 6-40V AC**  
**ELECTRIC VALVE 6-40V. AC**  
**ELECTROVANNE 6-40V. AC**  
**ELECTROVÁLVULA 6-40V 1**

Ref.	Ø (")			€	Dimensiones A-B-C
2521	1	-	15	53,4480	
2522	1 C/Reg	-	15	59,6280	
2523	1 1/2 C/Reg	-	10	100,8000	
2524	2 C/Reg	-	2	183,1800	
2525	3 C/Reg	-	2	226,4160	
2520	6-40V DC	-	-	38,4000	
2519	Adaptador	-	-	2,8800	

**Este sistema rentabiliza la instalación porque hay más válvulas en menos espacio, no necesita ni cinta o hilo de sellado, ni estopani estopa y reduce las horas de trabajo de las instalaciones**

*This system helps to improve the installation because there are more valves using less room, it does not need tape or sealant or filament and it cuts down working hours in the installations.*

**Dispone de dos gamas completas de electroválvulas de 24 VAC y de 6-40 VDC, en todas las medidas**

*It has two full lines of electric valves 24VAC and 6-40VDC, in all measures*

**Llave para apretar fitting. Ver herramientas**

**Torque wrench to tighten fitting. See tools.**



**Dispone de dos gamas completas de electroválvulas de 24VAC y de 6-40VDC, en todas las medidas**

*It has two full lines of electric valves 24VAC and 6-40VDC, in all measures*

**Permite trabajar en espacios reducidos gracias a sus tuercas locas. Facilita las posibles reparaciones posteriores de las válvulas.**

*It allows you to work in small places thanks to its sliding nuts. It facilitates possible repairs subsequent to the valves*





**TE CON JUNTA ELECTROVALVULA**  
ELECTRIC VALVE TEE CONNECTOR WITH JOINT  
**TE POUR ELECTROVALVES AVEC JOINT**  
TE COLETOR

**CRUZ CON JUNTA ELECTROVALVULA**  
ELECTRIC VALVE CROSS CONNECTOR WITH JOINT  
**CROIX POUR ELECTROVALVES AVEC JOINT**  
CRUZETA COLETOR

Ref.	Ø (")		€	Dimensiones A-B-C
0413	1	- 100	3,7294	94x75x45

Ref.	Ø (")		€	Dimensiones A-B-C
0423	1	- 100	5,8573	104x94x46



**CODO CON JUNTA ELECTROVALVULA**  
ELECTRIC VALVES ELBOW CONNECTORS WITH JOINT  
**COUDE POUR ELECTROVALVES AVEC JOINT**  
JOELHO COLETOR

**MANGUITO CON JUNTA ELECTROVALVULA**  
ELECTRIC VALVES COUPLING CONNECTORS WITH JOINT  
**MANCHON POUR ELECTROVALVES AVEC JOINT**  
UNIAO COLETORA

Ref.	Ø (")		€	Dimensiones A-B-C
0433	1	- 100	2,4825	77x74x45

Ref.	Ø (")		€	Dimensiones A-B-C
0443	1	- 100	2,1507	60x45x45



**TAPON HEMBRA CON JUNTA ELECTROVALVULA**  
ELECTRIC VALVES THREADED FEMALE PLUG WITH JOINT  
**BOUNCHON FEMELLE POUR ELECTROVALVES AVEC JOINT**  
TAMPAO COLETOR

**MACHON CON JUNTA ELECTROVALVULA**  
ELECTRIC VALVES THREADED MALE-MALE CONNECTOR WITH JOINT  
**DOUBLE MALE POUR ELECTROVALVES AVEC JOINT**  
CASQUILLO CLOETOR

Ref.	Ø (")		€	Dimensiones A-B-C
0453	1	- 100	1,1440	25x45x45

Ref.	Ø (")		€	Dimensiones A-B-C
0463	1	- 100	1,4872	40x38x38



**DIFUSOR EMERGENTE**  
**DIFFUSER POP-UP**  
**DIFFUSEUR EMERGENT**  
**DIFUSOR EMERG**

Ref.	Ø (") - (°) - (")			€	Dimensiones A-B-C
2611	1/2 - (0-360°) - 3	-	50	5,4111	



**DIFUSOR ESTATICO**  
**DIFFUSER STATIC**  
**DIFFUSEUR STATIQUE**  
**MICRODIFUSOR ESTATICO**

Ref.	Ø (")			€	Dimensiones A-B-C
2621	Tobera + Tuerca 1/2 H.	-	50	3,3176	
2600	Tobera	-	-	2,2880	
2601	Tuerca	-	-	1,6610	



**BOBINA RECORTABLE**  
**CUTTABLE COIL**  
**BOBINE AJUSTABLE**  
**BOBINA RECORTAVEIS**

Ref.	Ø (")			€	Dimensiones A-B-C
2631	1/2 - 1/2	-	150	0,4950	
2632	3/4 - 1/2	-	150	0,4950	
2633	3/4 - 3/4	-	120	0,6050	

### CARACTERÍSTICAS DEL DIFUSOR

- Regulable de 0° a 360°
- Dispone de válvula antidrenaje.
- Filtro grande que retiene la suciedad de fácil limpieza
- Muelle de acero inox. (ref. 2611)
- Hasta 700 l/h

### CHARACTERISTICS OF DIFFUSER

- Adjustable from 0° to 360°
- Provide of antidrainage valve
- Large filter that retains dirt and easy cleaning
- Spring of stainless steel (ref. 2611)
- Since 700 l/h

Presion (ATM)	Radio (m)
1,5	2,2
2	2
3	3,7
3,5	4

\*Datos técnicos orientativos obtenidos en nuestros laboratorios cualificados.

\*Technical orientative details obtained from our qualified technical laboratories.





Tabla de caudales en pagina 23  
Flow table on page 23

Tabla de caudales en pagina 23  
Flow table on page 23

**ASPERSOR ROTOR MINI**  
**MINI ROTARY SPRINKLER**  
**MINI ASPERSEUR ROTATIF**  
**ASPERSOR ROTOR MINI**

**ASPERSOR ROTOR PLUS**  
**ROTATOR SPRINKLER PLUS**  
**ASPERSEUR ROTATIF PLUS**  
**ASPERSOR ROTOR PLUS**

Ref.	Ø (Boq - ")			€	Dimensiones A-B-C
2653	2,45 - 1/2	-	200	1,0780	
2654	2,85 - 1/2	-	200	1,0780	
2655	3,25 - 1/2	-	200	1,0780	

Ref.	Ø (")			€	Dimensiones A-B-C
2660	2,5 - 1/2	-	50	10,4500	
2661	3,25 - 1/2	-	50	10,4500	
2662	4 - 1/2	-	50	10,4500	
2663	5 - 1/2	-	50	10,4500	



**TE NEBULIZADOR CONEXIÓN MICROTUBO**  
**NEBULIZER TEE MICROTUBE CONNECTION**  
**CONNEXION MICROTUBE TE NÉBULISEUR**  
**TE NEBULIZADOR CONEXAO MICROTUBO**

**CODO NEBULIZADOR CONEXIÓN MICROTUBO**  
**NEBULIZER ELBOW MICROTUBE CONNECTION**  
**CONNEXION MICROTUBE COUDE NÉBULISEUR**  
**JOELHO NEBULIZADOR CONEXAO MICROTUBO**

Ref.	Ø (mm)			€	Dimensiones A-B-C
N 2670	6	-	250	2,0000	
N 2671	8	-	250	2,0000	

Ref.	Ø (mm)			€	Dimensiones A-B-C
N 2680	6	-	250	2,0000	
N 2681	8	-	250	2,0000	

- 8 435277 932112
- 8 435277 932129
- 8 435277 932136
- 8 435277 932211
- 8 435277 932228
- 8 435277 932235
- 8 435277 932419
- 8 435277 932426
- 8 435277 932433
- 8 435277 932501
- 8 435277 932518
- 8 435277 932525
- 8 435277 932532
- 8 435277 932600
- 8 435277 932617
- 8 435277 932624
- 8 435277 932631
- 8 435277 932709
- 8 435277 932716
- 8 435277 932723
- 8 435277 932730
- 8 435277 932808
- 8 435277 932815
- 8 435277 932822
- 8 435277 932839
- 8 435277 932907
- 8 435277 932914



Tabla de caudales en pagina 23  
Flow table on page 23



Tabla de caudales en pagina 23  
Flow table on page 23

## MICROASPERSION SUPER BAILARINA SUPER MICRO SPLINKER SUPER MICROASPERSEUR MICROASPERSOR SUPER BAILARINA

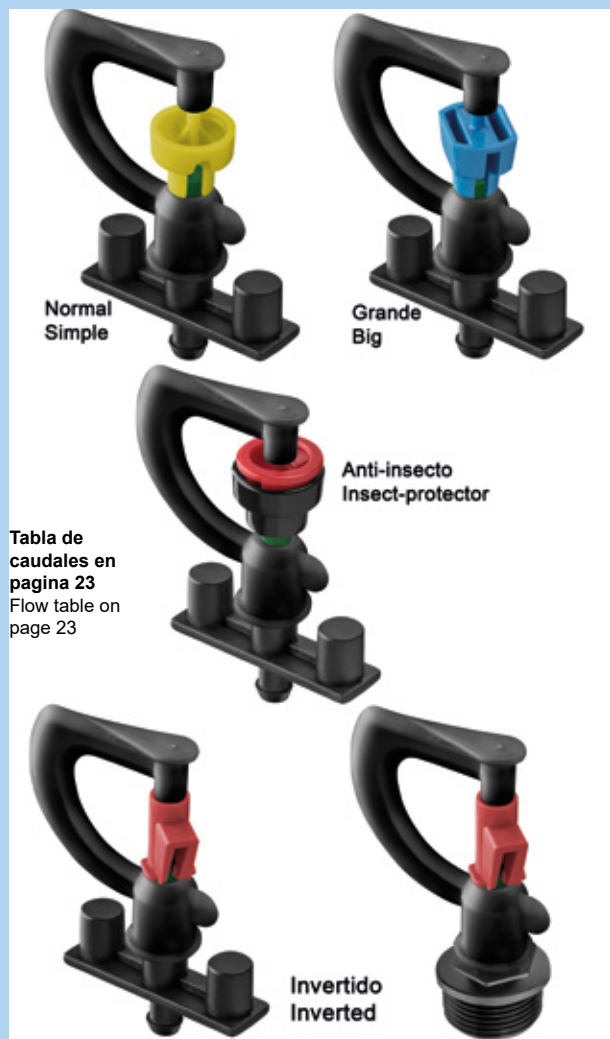
Ref.	Cap (l/h)			€	Dimensiones A-B-C
3211	70	100	1.000	0,4180	NORMAL SIMPLE
3212	100	100	1.000	0,4180	
3213	150	100	1.000	0,4180	
3221	70	100	1.000	0,4180	GRANDE BIG
3222	100	100	1.000	0,4180	
3223	150	100	1.000	0,4180	
3231	70	100	1.000	0,4180	INVERTIDA INVERTED
3232	100	100	1.000	0,4180	
3233	150	100	1.000	0,4180	
3235	70	100	1.000	0,4180	INVERTIDA -
3236	100	100	1.000	0,4180	ROSCA MACHO
3237	150	100	1.000	0,4180	INVERTED - MALE
3241	70	100	1.000	0,5060	ANTI-INSECTO
3242	100	100	1.000	0,5060	INSECT
3243	150	100	1.000	0,5060	PROTECTOR

## MICROASPERSOR SUPER DIFUSOR SUPER MICRO DIFUSER SUPER MICRODIFFUSEUR MICROASPERSOR SUPER DIFUSOR

Ref.	Cap (l/h)			€	Dimensiones A-B-C
3260	30	100	1.000	0,4180	90°
3261	70	100	1.000	0,4180	
3262	100	100	1.000	0,4180	
3263	150	100	1.000	0,4180	180°
3270	30	100	1.000	0,4180	
3271	70	100	1.000	0,4180	
3272	100	100	1.000	0,4180	360°
3273	150	100	1.000	0,4180	
3250	30	100	1.000	0,4180	
3251	70	100	1.000	0,4180	
3252	100	100	1.000	0,4180	
3253	150	100	1.000	0,4180	SECTORIAL BY ZONES
3280	30	100	1.000	0,4180	
3281	70	100	1.000	0,4180	
3282	100	100	1.000	0,4180	SECTORIAL BY ZONES
3283	150	100	1.000	0,4180	
3290	30	100	1.000	0,4180	
3291	70	100	1.000	0,4180	SECTORIAL BY ZONES
3292	100	100	1.000	0,4180	
3293	150	100	1.000	0,4180	





Tabla de caudales en pagina 23  
Flow table on page 23

Tabla de caudales en pagina 23  
Flow table on page 23

**MICROASPERSION SUPER BAILARINA C/ESTACA**  
**SUPER MICRO SPLINKER STAKE MOUNTED**  
**SUPER MICRO ASPERSEUR AVEC PIEU**  
**MICROASPERSOR SUPER BAILARINA C/ESTACA**

Ref.	Cap (l/h)			€	Dimensiones A-B-C
3215	70	25	250	1,5950	NORMAL SIMPLE
3216	100	25	250	1,5950	
3217	150	25	250	1,5950	

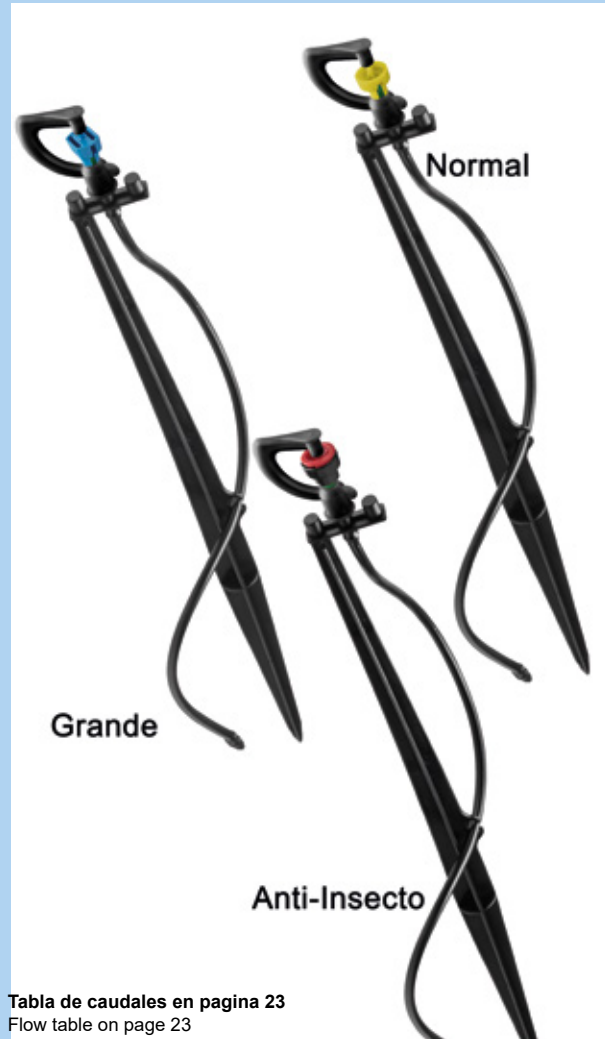
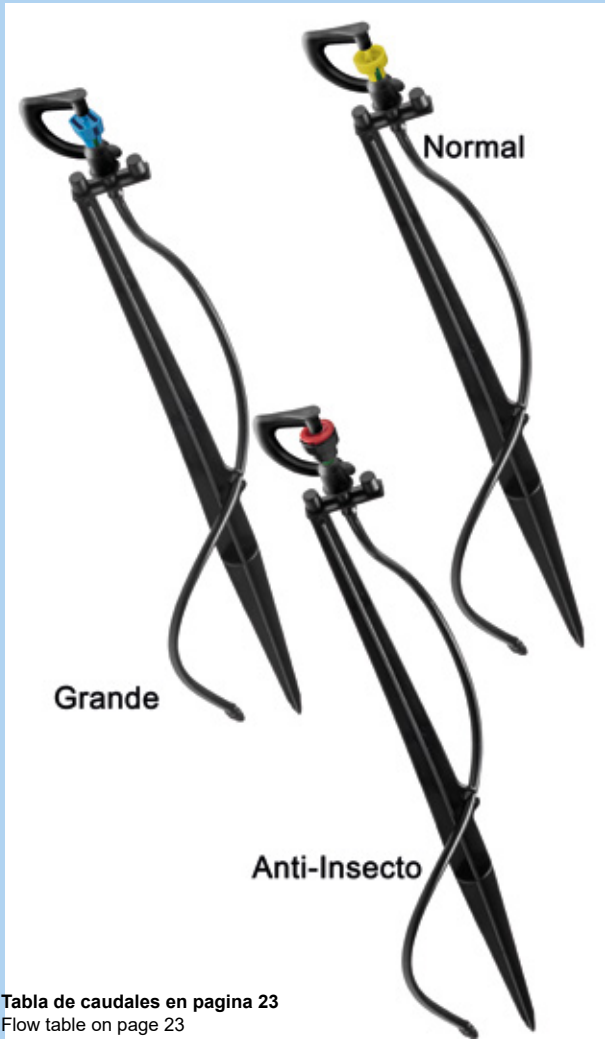
Ref.	Cap (l/h)			€	Dimensiones A-B-C
3225	70	25	250	1,5950	GRANDE BIG
3226	100	25	250	1,5950	
3227	150	25	250	1,5950	

Ref.	Cap (l/h)			€	Dimensiones A-B-C
3245	70	25	250	1,7050	ANTI-INSECTO
3246	100	25	250	1,7050	INSECT
3247	150	25	250	1,7050	PROTECTOR

**MICROASPERSOR SUPER DIFUSOR C/ESTACA**  
**SUPER MICRO DIFUSER STAKE MOUNTED**  
**SUPER MICRODIFFUSEUR AVEC PIEU**  
**MICROASPERSOR SUPER DIFUSOR C/ESTACA**

Ref.	Cap (l/h)			€	Dimensiones A-B-C
3264	30	25	250	1,5950	90°
3265	70	25	250	1,5950	
3266	100	25	250	1,5950	
3267	150	25	250	1,5950	
3274	30	25	250	1,5950	
3275	70	25	250	1,5950	180°
3276	100	25	250	1,5950	
3277	150	25	250	1,5950	
3254	30	25	250	1,5950	360°
3255	70	25	250	1,5950	
3256	100	25	250	1,5950	
3257	150	25	250	1,5950	
3284	30	25	250	1,5950	
3285	70	25	250	1,5950	RAYOS WATER WAY
3286	100	25	250	1,5950	
3287	150	25	250	1,5950	
3294	30	25	250	1,5950	SECTORIAL BY ZONES
3295	70	25	250	1,5950	
3296	100	25	250	1,5950	
3297	150	25	250	1,5950	





**MICROASPERSOR CIRCULAR**  
CIRCULAR SWING MICRO-SPRINKLER  
**MICROASPERSEUR CIRCULAIRE**  
MICROASPERSOR CIRCULAR

Ref.	Cap (l/h)			€	Dimensiones A-B-C
2341	40	100	1.000	0,4620	94x75x45
2340	85	100	1.000	0,4620	94x75x45
2345	85	5	500	0,5957	94x75x45



**MICROASPERSOR CON VARILLA**  
CIRCULAR SWING MICRO SPRINKLER WITH STICK  
**MICROASPERSEUR AVEC TIGE**  
CONJ MICROASP C/VARETA

Ref.	Cap (l/h)			€	Dimensiones A-B-C
2332	40	25	200	1,4345	495x37x14
2330	85	25	200	1,4345	495x37x14



**TOBERA ORIENTABLE CON VARILLA**  
MICRO DRIP IRRIGATION SPRAY NOZZLE WITH STICK  
**DIFFUSEUR AVEC TIGE**  
DIFUSOR ORIENTAVEL CON VARETA

Ref.	Cap (l/h)			€	Dimensiones A-B-C
2310	Pinchada - 80	25	200	1,4345	495x30x12



**TOBERA**  
MICRO DRIP IRRIGATION SPRAY NOZZLE  
**DIFFUSEUR**  
DIFUSOR

Ref.	Descripción			€	Dimensiones A-B-C
2320	Pinchada	1.000	5.000	0,1104	
2325	Pinchada	25	2.500	0,1324	
2322	Roscada	1.000	5.000	0,1104	
2323	Miniroscada	1.000	5.000	0,1104	



**MICROASPERSOR CON ESTACA**  
CIRCULAR SWING MICRO SPRINKLER WITH STAKE  
**MICROASPERSEUR AVEC PIEU**  
CONJ MICROASPER C/ESTACA

Ref.	Cap (l/h)			€	Dimensiones A-B-C
2333	40	25	200	1,0774	181x37x14
2331	85	25	200	1,0774	181x37x14



**TOBERA ORIENTABLE CON ESTACA**  
MICRO DRIP IRRIGATION SPRAY NOZZLE WITH STAKE  
**DIFFUSEUR AVEC PIEU**  
DIFUSOR ORIENTAVEL CON ESTACA

Ref.	Cap (l/h)			€	Dimensiones A-B-C
2312	Pinchada - 80	25	200	1,0151	167x30x13



## TABLAS ORIENTATIVAS MICROASPERSION SUPER

### NORMAL

	Caudal	Radio (m)
	70	2,60
	100	2,85
	150	2,90

### ANTI-INSECTO

	Caudal	Radio (m)
	70	3,30
	100	3,80
	150	3,90

### 360°

	Caudal	Radio (m)
	30	1,20
	70	2,00
	100	2,10
	150	2,40

### GRANDE

	Caudal	Radio (m)
	70	4,10
	100	4,40
	150	3,95

### 90°

	Caudal	Radio (m)
	30	2,20
	70	3,20
	100	3,30
150	3,50	

### Rayos

	Caudal	Radio (m)
	30	0,75
	70	1,10
	100	1,20
	150	1,30

### INVERTIDO

	Caudal	Radio (m)
	70	3,10
	100	3,35
	150	3,55

### 180°

	Caudal	Radio (m)
	30	1,60
	70	2,15
	100	2,40
	150	2,50

### Sectorial

	Caudal	Radio (m)
	30	1,50
	70	2,60
	100	2,80
	150	3,20

\*Microaspersores probados a 2 atm de presión. Datos técnicos orientativos obtenidos en nuestros laboratorios por técnicos cualificados.

\*Diameter of micro sprinklers obtained at 2 atm off pressure. Technical orientative details obtained from our qualified technical laboratories

## MICROASPERSION CIRCULAR

Ref.	Presión (atm)	Radio (m)	Caudal (l/h)	Ref.	Presión (atm)	Radio (m)	Caudal (l/h)
	0,5	1,10	23		0,5	1,70	60
	1	1,35	33		1	2,20	85
	1,5	1,50	41		1,5	2,60	110
	2	1,60	48		2	2,80	125
	2,5	1,80	53		2,5	2,90	135



### MICROASPERSOR CON LIMITADOR DE RADIO

MICRO-SPRINKLER WITH RADIUS LIMITER

MICRO-ARROSEUR AVEC LIMITEUR DE RAYON

MICROSPRINKLER COM LIMITADOR DE RAIO

Ref.	Cap (l/h)			€	Dimensiones A-B-C
N 2690	70	100	1.000	0,5060	
N 2691	100	100	1.000	0,5060	
N 2692	150	100	1.000	0,5060	

### ASPERSOR ROTOR MINI

Referencia	Presión 1,5 atm	
2653	Caudal (l/h)	265
	Radio (m)	10,6
2654	Caudal (l/h)	355
	Radio (m)	10,9
2655	Caudal (l/h)	460
	Radio (m)	11,1

### ASPERSOR ROTOR PLUS

Referencia		Presión (atm)		
		1	1,5	2
2660	Caudal (l/h)	216	250	279
	Radio (m)	5,35	5,85	6,25
2661	Caudal (l/h)	388	450	502
	Radio (m)	5,85	6,25	6,5
2662	Caudal (l/h)	618	713	797
	Radio (m)	6,25	6,5	6,7
2663	Caudal (l/h)	899	1.038	1.161
	Radio (m)	6,35	6,8	6,85



**2363**  
**2364**

**2365**

**Ejemplo de utilización**  
**Example of use**

**2352**

**2353**



2357

**NEW**

**NEW**

2356

2355

2350

2351

## ACCESORIOS ACCESSORIES COMPLMENTS ACCESORIOS

Ref.	Ø (")			€	Dimensiones A-B-C
2365	1/2"	-	500	0,3080	
2363	1/2 - 12 mm	-	500	0,5818	
2364	1/2 - 16 mm	-	500	0,5818	
2352	Sop. Tobera	1	1.000	0,2776	
2353	Microtubo	-	1.500	0,6411	

## VARILLAS Y ESTACAS BARS AND STAKE TIGES ET PIEUS VARETAS Y ESTACAS

Ref.	Descripción			€	Dimensiones A-B-C
2350	45 cm	-	1.000	0,4684	
2351	13 cm	-	1.000	0,2776	
2357	35 cm	-	400	0,7480	Doble conexión
N 2358	35 cm	-	600	0,6325	Doble conexión
N 2370	35 cm	-	500	0,6325	Doble conexión
2355	45 cm	-	500	0,4300	
2356	80 cm	-	100	1,4000	Doble conexión





### VENTOSA DOBLE EFECTO MACHO

AIR RELEASE VALVE DOUBLE EFFECT MALE WITH SPRINGY

SOUPAPE DE DÉTENTE DE DOBLE EFFET MÂLE

VENTOSA DUPLO EFEITO RM

Ref.	Ø (")		€	Dimensiones A-B-C
0721	1/2	- 250	0,9900	
0723	1	- 50	9,6800	
0726	2	- 20	16,500	



### VENTOSA DOBLE EFECTO

AIR RELEASE VALVE DOUBLE EFFECT

SOUPAPE DE DÉTENTE DE DOBLE EFFET

VALVULA DUPL EFEITO

Ref.	Ø (")		€	Dimensiones A-B-C
0731	16 - Manguera	- 200	1,0450	
0741	16 - Cinta	- 200	1,0450	
N 0761	16	- 200	0,7501	
N 0762	20	- 200	0,8006	



### MANOMETRO GLICERINA

GLYCERINE MANOMETER

MANOMETRE GLYCERINE

MANOMETRO GLICERINA

Ref.	Ø (")		€	Dimensiones A-B-C
0106	1/4 - 63 DN	1 54	27,0000	



### AMPLIACIÓN NEW MEASURES

### VENTOSA TRIPLE EFECTO MACHO

AIR RELEASE VALVE TRIPLE EFFECT MALE

SOUPAPE DE DÉTENTE DE TRIPLE EFFET

VENTOSA TRIPLO EFEITO

Ref.	Ø (")		€	Dimensiones A-B-C
A 0751	1/2	- 50	7,0000	
0752	3/4	- 25	30,8000	
0753	1	- 25	30,8000	
0754	2	- 25	88,0000	
A 0755	2 (NPT)	- 25	88,0000	



**ENLACE MICROTUBO HIDRAULICO**  
**HYDRAULIC MICROTUBE UNION**  
**RACCORD MICROTUBE HYDRAULIQUE**  
**UNIAO MICROTUBE HIDRAULIC**

Ref.	Ø (mm)			€	Dimensiones A-B-C
0661	6	50	500	1,6550	
0662	8	50	500	1,6550	



**ENLACE MICROTUBO HIDRAULICO - ROSCA MACHO**  
**HYDRAULIC MICROTUBE UNION - MALE THREADED**  
**RACCORD MICROTUBE HYDRAULIQUE - FILETE**  
**UNIAO MICROTUBE HIDRAULIC - R/M**

Ref.	Ø (mm)			€	Dimensiones A-B-C
0665	6 - 1/4	50	500	1,3017	
0666	6 - 1/8	50	500	1,3017	
0667	8 - 1/4	50	500	1,3017	
0668	8 - 1/8	50	500	1,3017	



**TAPÓN HIDRAULICO**  
**HYDRAULIC PLUG**  
**BOUCHON HYDRAULIQUE**  
**TACO HIDRAULICO**

Ref.	Ø (mm)			€	Dimensiones A-B-C
0655	1/4	150	900	0,8832	
0656	1/8	150	900	0,8832	



**TUERCA REDUCCIÓN PARA MANOMETRO**  
**REDUCING THREADED RACOR FOR MANOMETER**  
**RACCORD DE REDUCTION POUR MANOMETRE**  
**PORCA REDUCAO PARA MANOMETRO**

Ref.	Ø (mm)			€	Dimensiones A-B-C
0653	1/2 - 3/8	40	400	1,6800	
0652	1/2 - 1/8	40	400	1,6800	
0651	1/2 - 1/4	40	400	1,6800	

**STOP OCEAN PLASTIC POLLUTION**

La contaminación de nuestros ríos, mares y océanos por plásticos es una de las mayores problemáticas a nivel mundial. El agua es nuestro medio de vida y es por eso que todos debemos contribuir a evitar esta contaminación.

Desde Abrisla creemos que las empresas también debemos dar un paso al frente en este conflicto que afecta a todos. Es por este motivo por lo que, la nueva gama de accesorios hidráulicos se presentará en formato de caja de cartón. Desde un punto de vista de volumen, costes y logístico no sería necesario este cambio, pero creemos necesario este comienzo en la lucha contra esta causa.

Nuestro certificado en Sistema de Gestión Ambiental, de acuerdo a la norma UNE-EN ISO 14001:2015, nos compromete con el cumplimiento de las leyes ambientales y a reducir su impacto ambiental.



**MACHON ROSCADO HIDRAULICO**  
**HYDRAULIC THREADED UNION**  
**MANCHON FILETÉ HYDRAULIQUE**  
**CASQUILHO ROSCADO HIDRAULICO**

Ref.	Ø (mm)			€	Dimensiones A-B-C
0672	1/8	100	900	0,8832	
0671	1/4	100	900	0,8832	



**MACHON ROSCADO HIDRAULICO REDUCIDO**  
**MANCHON FILETE HYDRAULIQUE REDUIT**  
**REDUCED HYDRAULIC THREADED UNION**  
**CASQUILHO ROSCADO HIDRAULICO REDUCIDO**

Ref.	Ø (mm)			€	Dimensiones A-B-C
0675	1/8	100	900	0,8832	

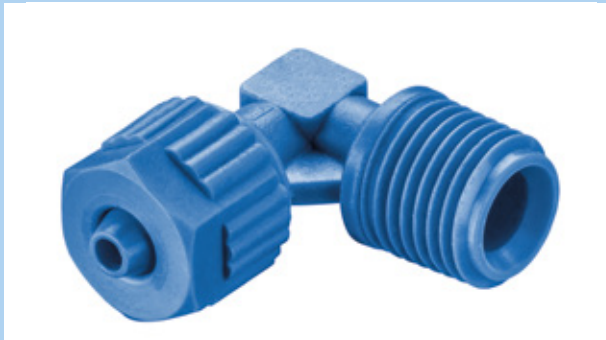

**CODO MICROTUBO HIDRAULICO - ROSCA MACHO**  
**HYDRAULIC MICROTUBE ELBOW - MALE THREADED**  
**COUDE MICROTUBE HYDRAULIQUE - FILETE**  
**JOELHO MICROTUBO HIDRAULICO - RM**

Ref.	Ø (mm)			€	Dimensiones A-B-C
0684	8 - 1/8	50	500	1,5629	
0681	6 - 1/4	50	500	1,5629	
0682	6 - 1/8	50	500	1,5629	
0683	8 - 1/4	50	500	1,5629	



**TE MICROTUBO HIDRAULICO**  
**HYDRAULIC MICROTUBE TEE**  
**TE MICROTUBE HYDRAULIQUE**  
**TE MICROTUBO HIDRAULICO**

Ref.	Ø (mm)			€	Dimensiones A-B-C
0691	6	25	250	2,4841	
0692	8	25	250	2,4841	



**TE MICROTUBO HIDRAULICO - ROSCA MACHO**  
**HYDRAULIC MICROTUBE TEE - MALE THREADED**  
**TE MICROTUBE HYDRAULIQUE - FILETE**  
**TE MICROTUBO HIDRAULICO - RM**

Ref.	Ø (mm)			€	Dimensiones A-B-C
0695	6 - 1/4	25	250	2,1005	
0696	8 - 1/4	25	250	2,1005	
0697	6 - 1/8	25	250	2,1005	
0698	8 - 1/8	25	250	2,1005	

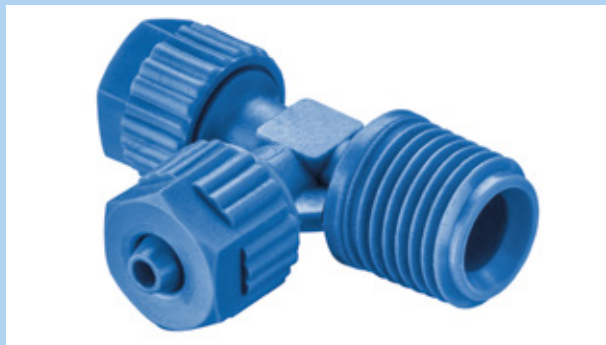

**TE MICROTUBO HIDRAULICO - ROSCA MACHO LATERAL**  
**HYDRAULIC MICROTUBE TEE - SIDE MALE THREADED**  
**TE MICROTUBE HYDRAULIQUE - LATERAL FILETE**  
**TE MICROTUBO HIDRAULICO - RM LATERAL**

Ref.	Ø (mm)			€	Dimensiones A-B-C
0685	6 - 1/8	25	250	2,1005	
0686	6 - 1/4	25	250	2,1005	
0687	8 - 1/8	25	250	2,1005	
0688	8 - 1/4	25	250	2,1005	





### UNIÓN SIMPLE

Idóneo para unir tubos a un bajo coste. Está fabricado en Polipropileno (PP)

### SIMPLE UNION

Ideal for joining pipes at a low cost. It is made of Polypropylene (PP)



### UNIÓN 4 PUNTAS

Mejor sujeción gracias a su diseño exclusivo. Está fabricado en Resina Acetalica (POM)

### 4 POINTED UNION

Best fixing thanks to its unique design. It is made from acetal resin. (POM)



### UNIÓN 4 SEGURIDAD

La anilla se abre en su cuerpo cónico reteniendo a la manguera en la unión.

### SAFETY UNION

The ring opens its conical body holding the tube in union.



### UNIÓN ACETAL

Mejor sujeción gracias a su diseño exclusivo. Está fabricado en Resina Acetalica (POM).

### ACETAL UNION

Best fixing thanks to its unique design. It is made from acetal resin. (POM)

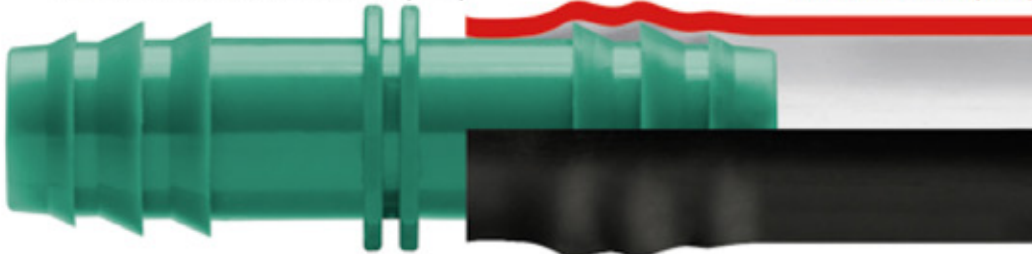

### UNIÓN COMPRESIÓN

Sujección máxima, la tuerca comprime a la manguera con el cuerpo de la unión.

### COMPRESSION UNION

Maximum fixing. The thread presses the tube with the union body

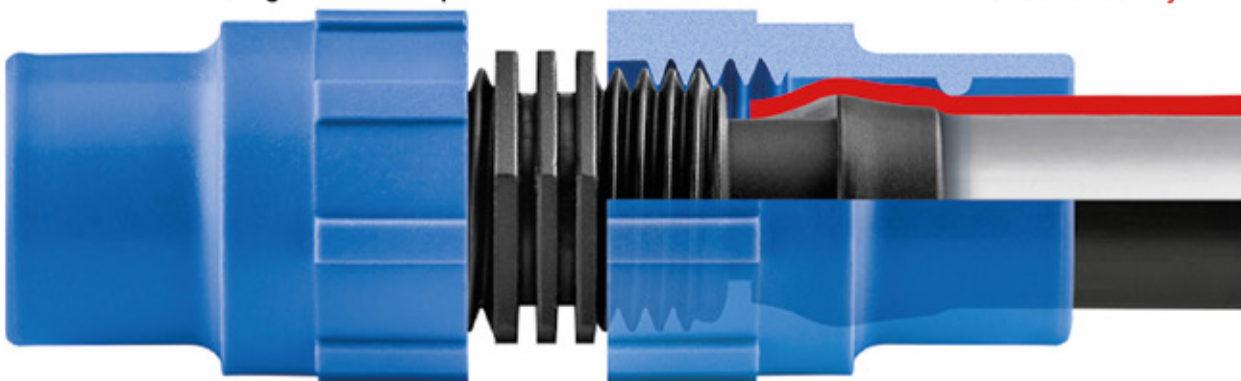



**ENLACE-TOMA MICROTUBO ACETAL**  
**MICROTUBE INTAKE CONNECTOR ACETAL**  
**JONCTION MICROTUBE DEPART ACETAL**  
**UNIAO TOMA ACETAL**

Ref.	Ø (mm)			€	Dimensiones A-B-C
<b>0823</b>	3x3	1.000	10.000	<b>0,0313</b>	
<b>0820</b>	5x3	1.000	10.000	<b>0,0313</b>	
<b>0821</b>	5x5	1.000	10.000	<b>0,0313</b>	
<b>0826</b>	<b>5x5</b>	<b>1.000</b>	<b>5.000</b>	<b>0,0914</b>	
<b>0822</b>	6x6	1.000	10.000	<b>0,0375</b>	



**LLAVE MICROTUBO ACETAL**  
**ACETAL MICROTUBE VALVE**  
**VANNE EN ACETAL MICROTUBE**  
**CHAVE MICROTUBO ACETAL**

Ref.	Ø (mm)			€	Dimensiones A-B-C
<b>0851</b>	5x5	100	500	<b>0,7072</b>	
<b>N 0860</b>	3x3	100	500	<b>0,9500</b>	
<b>N 0861</b>	5x5	100	500	<b>0,7500</b>	
<b>N 0862</b>	6x6	100	500	<b>1,2000</b>	



**CODO MICROTUBO ACETAL**  
**MICROTUBE ELBOW ACETAL**  
**COUDE MICROTUBE ACETAL**  
**JOELHO MICROTUBO ACETAL**

Ref.	Ø (mm)			€	Dimensiones A-B-C
<b>0833</b>	3x3	1.000	10.000	<b>0,2870</b>	
<b>0831</b>	5x5	1.000	10.000	<b>0,1253</b>	
<b>0836</b>	<b>5x5</b>	<b>50</b>	<b>5.000</b>	<b>0,2610</b>	
<b>0834</b>	6x6	1.000	10.000	<b>0,2870</b>	



**TE MICROTUBO ACETAL**  
**MICROTUBE TEE ACETAL**  
**TE MICROTUBE ACETAL**  
**TE MICROTUBO ACETAL**

Ref.	Ø (mm)			€	Dimensiones A-B-C
<b>0843</b>	3x3	1.000	10.000	<b>0,2610</b>	
<b>0841</b>	5x5	1.000	10.000	<b>0,0878</b>	
<b>0846</b>	<b>5x5</b>	<b>50</b>	<b>5.000</b>	<b>0,2610</b>	
<b>0844</b>	6x6	1.000	10.000	<b>0,2610</b>	



- 8 435277 909107
- 8 435277 909114
- 8 435277 909121
- 8 435277 909138
- 8 435277 909145
- 8 435277 909152
- 8 435277 909169
- 8 435277 909176
- 8 435277 909183
- 8 435277 909190
- 8 435277 909206
- 8 435277 909213
- 8 435277 909220
- 8 435277 909237
- 8 435277 909718
- 8 435277 909732
- 8 435277 909749
- 8 435277 909756
- 8 435277 909763
- 8 435277 909770
- 8 435277 909787
- 8 435277 909794



**ENLACE SIMPLE**  
**SIMPLE CONNECTOR**  
**RACCORD**  
**UNIAO SIMPLES**

Ref.	Ø (mm)			€	Dimensiones A-B-C
0910	12	100	2.000	0,0578	
0911	16	100	2.000	0,0715	
0919	16	10	1.000	0,0867	
0912	18	100	2.000	0,1157	
0913	20	100	2.000	0,1446	
0914	25	-	500	0,7223	
0915	32	-	500	0,8672	
0916	40	-	250	1,0105	
0917	50	-	100	1,2717	
0918	63	-	100	1,3874	



**UNION ROSCA MACHO SIMPLE**  
**MALE THREADED ACETAL CONNECTOR**  
**RACCORD FILETE MALE**  
**UNIAO RM SIMPLES**

Ref.	Ø (mm)			€	Dimensiones A-B-C
3024	1/2 - 12 (Acetal)	100	2.000	Pag 37	
0971	1/2 - 16	100	2.000	0,2024	
0979	1/2 - 16	5	1.000	0,2428	
0973	1/2 - 20	100	2.000	0,2313	
0974	3/4 - 25	-	500	0,7223	
0975	1 - 32	-	500	0,8672	
0976	1 1/4 - 40	-	250	1,0105	
0977	1 1/2 - 50	-	100	1,2717	
0978	2 - 63	-	100	1,2613	



**ENLACE REDUCIDO SIMPLE**  
**REDUCED CONNECTOR**  
**RACCORD REDUIT**  
**UNIAO REDUCAO**

Ref.	Ø (mm)			€	Dimensiones A-B-C
0920	16 - 12	100	2.000	0,1051	
0922	20 - 12	100	2.000	0,2482	
0921	20 - 16	100	2.000	0,1784	

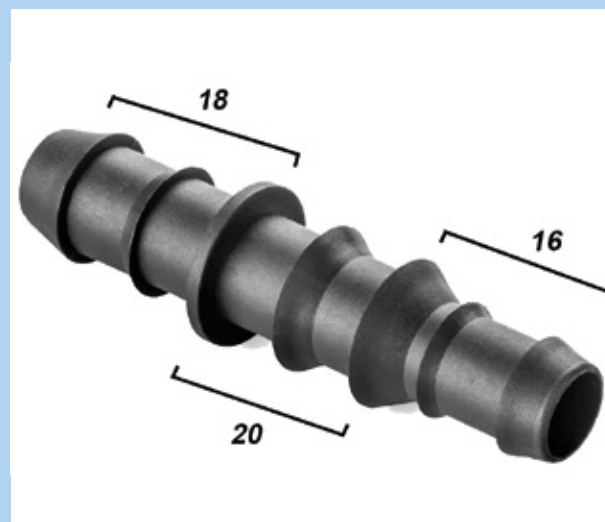

**ENLACE REDUCIDO SIMPLE**  
**REDUCED CONNECTOR**  
**RACCORD REDUIT**  
**UNIAO REDUZIDA ACETAL**

Ref.	Ø (mm)			€	Dimensiones A-B-C
0923	18 - 20 - 16	50	500	0,5170	





**TOMA NORMAL SIMPLE**  
**STANDARD INTAKE**  
**DEPART NORMAL**  
**TOMADA NORMAL**

**TOMA GRAN CAUDAL SIMPLE**  
**GREAT FLOW INTAKE**  
**RACCORD GRAN DEBIT**  
**TOMA GRAN CAUDAL**

Ref.	Ø (mm)			€	Dimensiones A-B-C
<b>1062</b>	<b>12 (Acetal)</b>	<b>100</b>	<b>2.000</b>	<b>Pag 34</b>	
<b>0951</b>	16	100	2.000	<b>0,0715</b>	
<b>0956</b>	<b>16</b>	<b>10</b>	<b>1.000</b>	<b>0,0867</b>	
<b>1451</b>	17	100	2.000	<b>0,1462</b>	
<b>0952</b>	18	100	2.000	<b>0,1446</b>	
<b>0953</b>	20	100	2.000	<b>0,1446</b>	

Ref.	Ø (mm)			€	Dimensiones A-B-C
<b>0960</b>	16	100	2.000	<b>0,0715</b>	
<b>0962</b>	18	100	2.000	<b>0,1446</b>	
<b>0961</b>	20	100	2.000	<b>0,1446</b>	



**CODO SIMPLE**  
**ELBOW**  
**COUDE**  
**JOELHO**

**TE SIMPLE**  
**TEE**  
**TE**  
**TE**

Ref.	Ø (mm)			€	Dimensiones A-B-C
<b>1082</b>	<b>12 (Acetal)</b>	<b>100</b>	<b>1.000</b>	<b>Pag 35</b>	
<b>0931</b>	16	100	1.000	<b>0,1573</b>	
<b>0936</b>	<b>16</b>	<b>5</b>	<b>500</b>	<b>0,2075</b>	
<b>0933</b>	20	100	1.000	<b>0,2076</b>	
<b>0934</b>	25	-	500	<b>0,8800</b>	
<b>0935</b>	32	-	500	<b>1,2320</b>	
<b>0937</b>	40	-	150	<b>1,6500</b>	
<b>0938</b>	50	-	100	<b>1,9800</b>	
<b>0939</b>	63	-	50	<b>3,0800</b>	

Ref.	Ø (mm)			€	Dimensiones A-B-C
<b>1092</b>	<b>12 (Acetal)</b>	<b>100</b>	<b>1.000</b>	<b>Pag 36</b>	
<b>0941</b>	16	100	1.000	<b>0,1573</b>	
<b>0946</b>	<b>16</b>	<b>5</b>	<b>500</b>	<b>0,1892</b>	
<b>0942</b>	18	100	1.000	<b>0,2478</b>	
<b>1098</b>	<b>20 (Acetal)</b>	<b>50</b>	<b>1.000</b>	<b>Pag 36</b>	
<b>0944</b>	25	-	200	<b>0,8800</b>	
<b>0945</b>	32	-	200	<b>1,2320</b>	
<b>0947</b>	40	-	150	<b>1,6500</b>	
<b>0948</b>	50	-	100	<b>2,7500</b>	
<b>0949</b>	63	-	50	<b>3,8500</b>	





8 435277 910110



8 435277 910165



8 435277 910219



8 435277 910264



8 435277 910318



8 435277 910363



8 435277 910417



8 435277 910462



**TOMA GRAN CAUDAL 4 PUNTAS ACETAL**  
**GREAT FLOW INTAKE WITH 4 POINTED ACETAL**  
**RACCORD GRAN DEBIT AVEC 4 POINTES ACETAL**  
**TOMA GRAN CAUDAL 4 PONTAS ACETAL**

Ref.	Ø (mm)			€	Dimensiones A-B-C
1011	16	100	2.000	0,0894	
1016	16	10	1.000	0,1074	



**ENLACE 4 PUNTAS ACETAL**  
**CONNECTOR WITH 4 POINTED ACETAL**  
**RACCORD AVEC 4 POINTES ACETAL**  
**UNIAO 4 PONTAS ACETAL**

Ref.	Ø (mm)			€	Dimensiones A-B-C
1021	16	100	2.000	0,0894	
1026	16	10	1.000	0,1074	



**CODO 4 PUNTAS ACETAL**  
**ELBOW WITH 4 POINTED ACETAL**  
**COUDE AVEC 4 POINTES ACETAL**  
**JOELHO 4 PONTAS ACETAL**

Ref.	Ø (mm)			€	Dimensiones A-B-C
1031	16	100	1.000	0,1766	
1036	16	5	500	0,1943	



**TE 4 PUNTAS ACETAL**  
**TEE WITH 4 POINTED ACETAL**  
**TE AVEC 4 POINTES ACETAL**  
**TE 4 PONTAS ACETAL**

Ref.	Ø (mm)			€	Dimensiones A-B-C
1041	16	100	1.000	0,2367	
1046	16	5	500	0,2603	

DISPONEMOS DE TODAS  
LAS MEDIDAS



2360

3053  
3054

DISPONEMOS DE TODAS  
LAS MEDIDAS



2361

3051



**ACOPLE ACETAL A MANGUERA**  
ACETAL COUPLING UNION FOR HOSE OUTPUT  
RACCORD EMBOUTI EN ACETAL POUR TUYAU  
ACOPLE MANGUERA ACETAL

**TOMA ADAPTADOR ACETAL**  
ACETAL ADAPTER INTAKE  
ADAPTATEUR DEPART EN ACETAL  
TOMA CUELLO ACOPLE ACETAL

Ref.	Ø (")		€	Dimensiones A-B-C
2360	12 - T. Normal	100 2.000	0,0715	
3053	16 - T. Gran Caudal	100 2.000	0,1200	
3054	20 - T. Gran Caudal	100 2.000	0,1200	

Ref.	Ø (")		€	Dimensiones A-B-C
2361	Toma Normal	100 2.000	0,0715	
3051	T. Gran Caudal	100 2.000	0,1200	

DISPONEMOS DE TODAS  
LAS MEDIDAS



3052

2362

DISPONEMOS DE TODAS  
LAS MEDIDAS



3055

3056

**TAPÓN ACETAL**  
ACETAL PLUG  
BOUNCHON EN ACETAL  
TAPON ACOPLE ACETAL

**ACOPLE ACETAL A CINTA**  
ACETAL COUPLING UNION FOR TAPE OUTPUT  
RACCORD EMBOUTI EN ACETAL POUR TUYAU PLAT  
ACOPLE CINTA ACETAL

Ref.	Ø (")		€	Dimensiones A-B-C
2362	Toma Normal	100 2.000	0,0715	
3052	T. Gran Caudal	100 2.000	0,1200	

Ref.	Ø (")		€	Dimensiones A-B-C
3055	16 - T. Gran Caudal	100 2.000	0,2800	Roscada
3056	16 - T. Gran Caudal	100 2.000	0,2800	Extra



- 8 435277 910509
- 8 435277 910523
- 8 435277 910530
- 8 435277 910547
- 8 435277 910554
- 8 435277 910561
- 8 435277 910578
- 8 435277 910585
- 8 435277 910592
- 8 435277 910608
- 8 435277 910622
- 8 435277 910639
- 8 435277 910646
- 8 435277 910653
- 8 435277 910660
- 8 435277 910677
- 8 435277 910691
- 8 435277 910707
- 8 435277 910721
- 8 435277 910738
- 8 435277 910745
- 8 435277 910752
- 8 435277 910769
- 8 435277 910776
- 8 435277 910783
- 8 435277 910790



**ENLACE ACETAL**  
**ACETAL UNION**  
**RACCORD EN ACETAL**  
**UNIAO ACETAL**

Ref.	Ø (mm)			€	Dimensiones A-B-C
1052	12	100	2.000	0,0650	
1055	16	100	2.000	0,0965	
1050	16	10	1.000	0,1219	
1054	16	100	2.000	0,1219	
3036	16	10	1.000	0,1158	
1053	17	100	2.000	0,1342	
1059	18	100	2.000	0,1178	
1058	20	100	2.000	0,1180	



**ENLACE ACETAL REDUCIDO**  
**ACETAL REDUCED UNION**  
**RACCORD REDUIT EN ACETAL**  
**UNIAO ACETAL REDUZIDA**

Ref.	Ø (mm)			€	Dimensiones A-B-C
1056	17 - 16	100	2.000	0,1416	0,0715
1057	20 - 16	100	2.000	0,1896	0,1446



**TOMA NORMAL ACETAL**  
**ACETAL NORMAL INTAKE**  
**DEPART NORMAL EN ACETAL**  
**TOMADA NORMAL ACETAL**

Ref.	Ø (mm)			€	Dimensiones A-B-C
1062	12	100	2.000	0,0650	
1066	16	100	2.000	0,0965	
1060	16	10	1.000	0,1219	
1064	16	100	2.000	0,1219	
3035	16	10	1.000	0,1158	
1063	17	100	2.000	0,1342	
1061	17	100	2.000	0,1342	
1069	18	100	2.000	0,1178	



**TOMA GRAN CAUDAL ACETAL**  
**ACETAL GREAT FLOW INTAKE**  
**DEPART GRAND DEBIT EN ACETAL**  
**TOMA GRAN CAUDAL ACETAL**

Ref.	Ø (mm)			€	Dimensiones A-B-C
1076	16	100	2.000	0,0965	
1070	16	10	1.000	0,1219	
1074	16	100	2.000	0,1219	
1073	17	100	2.000	0,1342	
1071	17	100	2.000	0,1342	
1079	18	100	2.000	0,1178	
1078	20	100	2.000	0,1180	

**AMPLIACIÓN  
NEW MEASURES**



**TOMA MICRO ACETAL**  
**ACETAL MICRO INTAKE**  
**MICRO DEPART EN ACETAL**  
**TOMADA MICRO ACETAL**

Ref.	Ø (mm)			€	Dimensiones A-B-C
<b>1072</b>	12 x 5	100	2.000	<b>0,0650</b>	
<b>A 1068</b>	16 x 5	100	2.000	<b>0,1219</b>	



**CODO ACETAL**  
**ACETAL ELBOW**  
**COUDE EN ACETAL**  
**JOELHO ACETAL**

Ref.	Ø (mm)			€	Dimensiones A-B-C
<b>1082</b>	12	100	1.000	<b>0,1130</b>	
<b>1067</b>	16	100	1.000	<b>0,2280</b>	
<b>1080</b>	16	10	1.000	<b>0,2880</b>	
<b>1084</b>	16	100	2.000	<b>0,2880</b>	
<b>3037</b>	16	5	500	<b>0,2736</b>	
<b>1083</b>	17	100	1.000	<b>0,3360</b>	
<b>1083</b>	17	100	1.000	<b>0,3360</b>	
<b>1089</b>	18	100	1.000	<b>0,3175</b>	
<b>1088</b>	20	100	1.000	<b>0,3200</b>	



**CODO TOMA GRAN CAUDAL ACETAL**  
**ELBOW WITH GREAT FLOW INTAKE ACETAL**  
**COUDE DEPART GRAND DEBIT EN ACETAL**  
**JOELHO TOMA GRAN CAUDAL ACETAL**

Ref.	Ø (mm)			€	Dimensiones A-B-C
<b>3085</b>	16	100	1.000	<b>0,4100</b>	



**CODO ROSCA MACHO ACETAL**  
**ACETAL MALE THREADED ELBOW**  
**COUDE FILETÉ ACETAL**  
**JOELHO RM ACETAL**

Ref.	Ø (mm - ")			€	Dimensiones A-B-C
<b>3070</b>	16 - 1/2	100	1.000	<b>0,4100</b>	
<b>3071</b>	16 - 3/4	100	1.000	<b>0,4100</b>	
<b>3072</b>	20 - 1/2	100	1.000	<b>0,4700</b>	
<b>3073</b>	20 - 3/4	100	1.000	<b>0,4700</b>	

- 8 435277 910905
- 8 435277 910929
- 8 435277 910936
- 8 435277 910943
- 8 435277 910950
- 8 435277 910967
- 8 435277 910974
- 8 435277 910981
- 8 435277 910998
- 8 435277 930309
- 8 435277 930316
- 8 435277 930323
- 8 435277 930330
- 8 435277 930347
- 8 435277 930606
- 8 435277 930613
- 8 435277 930620
- 8 435277 930637



**TE ACETAL**  
**ACETAL TEE**  
**TE EN ACETAL**  
**TE ACETAL**

Ref.	Ø (mm)			€	Dimensiones A-B-C
1092	12	100	1.000	0,1178	
1077	16	100	1.000	0,2660	
1090	16	10	1.000	0,3360	
1094	16	100	1.000	0,3360	
3038	16	5	500	0,3192	
1093	17	100	2.000	0,3840	
1091	17	100	2.000	0,3840	
1099	18	100	1.000	0,3345	
1098	20	50	1.000	0,3600	



**TE REDUCIDA ACETAL**  
**ACETAL TEE REDUCED**  
**TE EN ACETAL POUR REDUCCION**  
**TE ACETAL REDUZIDA**

Ref.	Ø (mm - ")			€	Dimensiones A-B-C
3031	16 - 12 - 16	100	2.000	0,4100	
3030	16 - 20 - 16	100	1.000	0,4100	
3033	20 - 12 - 20	50	1.000	0,4700	
3032	20 - 16 - 20	50	1.000	0,4700	
3034	20 - 25 - 20	50	500	0,4700	



**TE CON TOMA GRAN CAUDAL ACETAL**  
**TEE WITH GREAT FLOW INTAKE ACETAL**  
**TE DEPART GRAND DEBIT EN ACETAL**  
**TE TOMA GRAN CAUDAL ACETAL**

Ref.	Ø (mm)			€	Dimensiones A-B-C
3080	16	100	1.000	0,4100	



**TE ROSCA MACHO ACETAL**  
**ACETAL MALE THREADED TEE**  
**TE FILETÉ ACETAL**  
**TE RM ACETAL**

Ref.	Ø (mm - ")			€	Dimensiones A-B-C
3060	16 - 1/2 - 16	100	1.000	0,4100	
3061	16 - 3/4 - 16	100	1.000	0,4100	
3062	20 - 1/2 - 20	50	1.000	0,4700	
3063	20 - 3/4 - 20	50	1.000	0,4700	





**UNION ROSCA MACHO ACETAL**  
**MALE THREADED ACETAL CONNECTOR**  
**RACCORD FILETE MALE ACETAL**  
**UNIAO RM ACETAL**

Ref.	Ø (mm - ")			€	Dimensiones A-B-C
3024	1/2 - 12	100	2.000	0,1840	
3020	1/2 - 16	100	2.000	0,2800	
3039	1/2 - 16	10	1.000	0,3192	
3021	1/2 - 20	100	2.000	0,2800	
3022	3/4 - 16	100	2.000	0,2800	
3023	3/4 - 20	100	2.000	0,2800	



**UNION ROSCA HEMBRA ACETAL CON TUERCA LOCA**  
**ACETAL ROTATING FEMALE THREADED UNION**  
**RACCORD EN ACETAL ECROU TOURNANT**  
**UNIAO ROSCA FEMEA COM PORCA LOCA**

Ref.	Ø (mm - ")			€	Dimensiones A-B-C
3012	3/4 - 5	100	1.000	0,9800	
3018	3/4 - 5	5	500	1,5480	
3010	1/2 - 16	100	1.000	0,4400	
3016	1/2 - 16	5	500	0,5280	
3011	3/4 - 16	50	1.000	0,6400	
3017	3/4 - 16	5	500	0,7680	
3013	3/4 - 20	50	1.000	0,6400	



**CRUZ ACETAL**  
**ACETAL CROSS**  
**CROIX EN ACETAL**  
**CRUZETA ACETAL**

Ref.	Ø (mm)			€	Dimensiones A-B-C
3040	16	50	500	0,6800	
3041	20	50	500	0,6800	



**CRUZ ACETAL ROSCA MACHO**  
**MALE THREADED ACETAL CROSS**  
**CROIX EN ACETAL FILETE MALE**  
**CRUZETA ROSCA MACHO ACETAL**

Ref.	Ø (mm - ")			€	Dimensiones A-B-C
3042	1/2 - 16 - 16 - 16	50	500	0,6800	
3043	1/2 - 20 - 20 - 20	50	500	0,6800	
3044	3/4 - 16 - 16 - 16	50	500	0,6800	
3045	3/4 - 20 - 20 - 20	50	500	0,6800	





8 435277 910653



8 435277 910752



8 435277 910851



8 435277 910868



8 435277 910875



8 435277 910950



8 435277 910967



8 435277 910974



**“Y” ACETAL 2 SALIDAS A MANGUERA**  
**ACETAL “Y” 2 OUTPUTS - HOSE**  
**“Y” 2 RACCORDS EN ACETAL - TUYAU**  
**“Y” ACETAL 2 SAIDAS - MANGUEIRA**

Ref.	Ø (mm)			€	Dimensiones A-B-C
1085	16 / 16 - 16	50	500	0,5289	
1065	20 / 16 - 16	50	500	0,5289	



**“Y” ACETAL 3 SALIDAS A MANGUERA**  
**ACETAL “Y” 3 OUTPUTS - HOSE**  
**“Y” 3 RACCORDS EN ACETAL - TUYAU**  
**“Y” ACETAL 3 SAIDAS - MANGUEIRA**

Ref.	Ø (mm)			€	Dimensiones A-B-C
1095	16 / 16 - 16 - 16	50	500	0,5770	
1075	20 / 16 - 16 - 16	50	500	0,5770	



**“Y” ACETAL TOMA GRAN CAUDAL 2 SALIDAS A MANGUERA**  
**ACETAL “Y” 2 OUTPUTS - GREAT FLOW INTAKE**  
**“Y” 2 RACCORDS EN ACETAL - GRAND DEBIT**  
**“Y” ACETAL 2 SAIDAS - TOMA GRAN CAUDAL**

Ref.	Ø (mm)			€	Dimensiones A-B-C
1086	16	50	500	0,5289	



**“Y” ACETAL TOMA GRAN CAUDAL 3 SALIDAS A MANGUERA**  
**ACETAL “Y” 3 OUTPUTS - GREAT FLOW INTAKE**  
**“Y” 3 RACCORDS EN ACETAL - GRAND DEBIT**  
**“Y” ACETAL 3 SAIDAS - TOMA GRAN CAUDAL**

Ref.	Ø (mm)			€	Dimensiones A-B-C
1096	16	50	500	0,5770	



**“Y” ACETAL ROSCA MACHO 2 SALIDAS A MANGUERA**  
**ACETAL “Y” 2 OUTPUTS - MALE THREADED**  
**“Y” 2 RACCORDS EN ACETAL - MALE FILETE**  
**“Y” ACETAL 2 SAIDAS - RM**

Ref.	Ø (” - mm)			€	Dimensiones A-B-C
1087	1/2 / 16 - 16	50	500	0,5289	



**“Y” ACETAL ROSCA MACHO 3 SALIDAS A MANGUERA**  
**ACETAL “Y” 3 OUTPUTS - MALE THREADED**  
**“Y” 3 RACCORDS EN ACETAL - MALE FILETE**  
**“Y” ACETAL 3 SAIDAS - RM**

Ref.	Ø (” - mm)			€	Dimensiones A-B-C
1097	3/4 / 16 - 16 - 16	50	500	0,5770	



**JUNTA BILABIAL**  
**TWO LIPS JOINT**  
**JOINT DEUX LÈVRES**  
**BORRACHA BILABIAL**

**JUNTA SIMPLE**  
**SIMPLE JOINT**  
**JOINT SIMPLE**  
**BORRACHA SIMPLE**

Ref.	Ø (")			€	Dimensiones A-B-C
0980	Toma Nomal	100	2.000	0,1854	
0981	Toma Gran Caudal	100	2.000	0,2315	

Ref.	Ø (")			€	Dimensiones A-B-C
0990	Microtubo	500	4.000	0,1144	
0991	Normal	100	4.000	0,1144	
0992	Toma Gran Caudal	100	4.000	0,1373	



**JUNTA BILABIAL:**

Se aconseja que en las tuberías de PVC, o de durezas similares, se limen los cantos vivos de los orificios antes de su montaje. Para un correcto funcionamiento es necesario que la persona que lo instale conozca estos consejos.

**BILABIAL JOINT:**

*It is advisable to smooth the limit of PVC pipes' exits or those made of similar hardness before the installation. Anyone who wish to install it needs to know this for better performance*





8 435277 911100



8 435277 911117



8 435277 911124



8 435277 911131



8 435277 911162



8 435277 911209



8 435277 911216



8 435277 911223



8 435277 911308



8 435277 911315



8 435277 911339



8 435277 911360



8 435277 911407



8 435277 911414



8 435277 911421



8 435277 911438



8 435277 911445



**ENLACE DE SEGURIDAD**  
**UNION WITH SAFETY RING**  
**RACCORD DE SÉCURITÉ**  
**UNIAO SEGURANÇA**

Ref.	Ø (mm)			€	Dimensiones A-B-C
1110	12	100	2.000	0,1656	
1111	16	100	2.000	0,1761	
1116	16	10	1.000	0,2124	
1112	18	100	2.000	0,2483	
1113	20	100	2.000	0,2483	



**ENLACE REDUCIDO DE SEGURIDAD**  
**REDUCED UNION WITH SAFETY RING**  
**RACCORD REDUIT DE SÉCURITÉ**  
**UNIAO REDUZIDA SEGURANÇA**

Ref.	Ø (mm)			€	Dimensiones A-B-C
1120	16 - 12	100	2.000	0,2209	
1121	20 - 16	100	2.000	0,2483	
1122	20 - 12	100	2.000	0,3862	
0923	18 - 20 - 16	50	500	Pag 30	



**TOMA NORMAL SEGURIDAD**  
**NORMAL INTAKE WITH SAFETY RING**  
**DEPART DE SÉCURITÉ**  
**TOMADA SEGURANÇA NORMAL**

Ref.	Ø (mm)			€	Dimensiones A-B-C
1130	12	100	2.000	0,1103	
1131	16	100	2.000	0,1375	
1136	16	10	1.000	0,1516	
1133	20	100	2.000	0,1656	



**TOMA GRAN CAUDAL DE SEGURIDAD**  
**GREAT FLOW INTAKE WITH SAFETY RING**  
**DEPART GRAND DÉBIT DE SÉCURITÉ**  
**TOMADA SEGURANÇA GRAN CAUDAL**

Ref.	Ø (mm)			€	Dimensiones A-B-C
1140	12	100	2.000	0,1103	
1141	16	100	2.000	0,1379	
1142	18	100	2.000	0,1656	
1143	20	100	2.000	0,1656	



**TOMA GRAN CAUDAL SEGURIDAD ACETAL**  
**ACETAL GREAT FLOW INTAKE WITH SAFETY RING**  
**DEPART GRAND DEBIT DE SÉCURITÉ EN ACETAL**  
**TOMADA SEGURANÇA GRAN CAUDAL ACETAL**

Ref.	Ø (mm)			€	Dimensiones A-B-C
1144	16	100	2.000	0,1375	



**CODO SEGURIDAD**  
**ELBOW WITH SAFETY RING**  
**COUDE DE SÉCURITÉ**  
**JOELHO SEGURANÇA**

Ref.	Ø (mm)			€	Dimensiones A-B-C
1082	12	100	1.000	Pag 35	
1151	16	100	1.000	0,3385	
1156	16	5	500	0,3723	
1152	18	100	1.000	0,3386	
1153	20	100	1.000	0,3386	



**CODO CON TOMA GRAN CAUDAL SEGURIDAD**  
**GREAT FLOW INTAKE ELBOW WITH SAFETY RING**  
**COUDE DEPART GRAND DEBIT DE SÉCURITÉ**  
**JOELHO TOMADA GRAN CAUDAL SEGURANÇA**

Ref.	Ø (mm)			€	Dimensiones A-B-C
1291	16	100	1.000	0,4950	



**CODO ROSCA MACHO SEGURIDAD**  
**MALE THREADED ELBOW WITH SAFETY RING**  
**COUDE FILETÉ DE SÉCURITÉ**  
**JOELHO RM SEGURANÇA**

Ref.	Ø (mm - ")			€	Dimensiones A-B-C
1251	16 - 1/2	100	1.000	0,4740	
1256	16 - 1/2	5	500	0,5214	
1253	20 - 1/2	100	1.000	0,4740	
1254	16 - 3/4	100	1.000	0,4950	
1255	20 - 3/4	100	1.000	0,4950	



**TE SEGURIDAD**  
**TEE WITH SAFETY RING**  
**TE DE SÉCURITÉ**  
**TE SEGURANÇA**

Ref.	Ø (mm)			€	Dimensiones A-B-C
1170	12	100	2.000	0,2706	
1171	16	100	2.000	0,3159	
1176	16	5	500	0,3475	
1172	18	50	2.000	0,4738	
1173	20	50	2.000	0,3385	



**TE REDUCIDA SEGURIDAD**  
**REDUCED TEE WITH SAFETY RING**  
**TE REDUIT DE SÉCURITÉ**  
**TE REDUZIDA SEGURANÇA**

Ref.	Ø (mm)			€	Dimensiones A-B-C
1180	16 - 12 - 16	50	1.000	0,3610	
1181	20 - 16 - 20	50	1.000	0,3836	
1182	16 - 20 - 16	50	1.000	0,4514	



**TE CON TOMA GRAN CAUDAL SEGURIDAD**  
**TE GREAT FLOW INTAKE WITH SAFETY RING**  
**TE DEPART GRAND DÉBIT DE SÉCURITÉ**  
**TE TOMA GRAN CAUDAL SEGURANÇA**

Ref.	Ø (mm)			€	Dimensiones A-B-C
1191	16	100	1.000	0,4950	



**TE ROSCA MACHO SEGURIDAD**  
**MALE THREADED TEE WITH SAFETY RING**  
**TE FILETE DE SÉCURITÉ**  
**TE RM SEGURANÇA**

Ref.	Ø (mm - ")			€	Dimensiones A-B-C
1211	16 - 1/2	50	1.000	0,4741	
1216	16 - 1/2	5	500	0,5214	
1213	20 - 1/2	50	1.000	0,4741	
1214	3/4 - 16	50	1.000	0,4950	
1215	3/4 - 20	50	1.000	0,4950	





**UNION ROSCA MACHO SEGURIDAD**  
**MALE THREADED UNION WITH SAFETY RING**  
**RACCORD FILETÉ DE SÉCURITÉ**  
**URM SEGURANÇA**

**UNION ROSCA HEMBRA SEGURIDAD**  
**THREADED FEMALE WITH SAFETY RING**  
**RACCORD FEMELE TARAUDE DE SÉCURITÉ**  
**URH SEGURANÇA**

Ref.	Ø (mm - ")			€	Dimensiones A-B-C
1231	16 - 1/2	100	2.000	0,2633	
1236	16 - 1/2	5	1.000	0,2994	
1232	18 - 1/2	100	2.000	0,2633	
1233	20 - 1/2	100	2.000	0,2633	
1241	3/4 - 16	100	2.000	0,2924	
1243	3/4 - 20	100	2.000	0,2924	
1221	3/8 - 16	100	2.000	0,2633	
1223	3/8 - 20	100	2.000	0,2633	

Ref.	Ø (mm - ")			€	Dimensiones A-B-C
1271	16 - 1/2	100	1.000	0,7374	
1276	16 - 1/2	5	500	0,8112	
1273	20 - 1/2	100	1.000	0,7374	
1281	3/4 - 16	100	1.000	0,7898	
1286	3/4 - 16	5	500	0,8688	
1283	3/4 - 20	100	1.000	0,7898	



**CRUZ SEGURIDAD**  
**CROSS WITH SAFETY RING**  
**CROIX DE SÉCURITÉ**  
**CRUZ SEGURANÇA**

**CRUZ ROSCA MACHO SEGURIDAD**  
**MALE THREADED CROSS WITH SAFETY RING**  
**CROIX FILETÉ DE SÉCURITÉ**  
**CRUZ RM SEGURANÇA**

Ref.	Ø (mm)			€	Dimensiones A-B-C
1161	16 - 16 - 16 - 16	50	500	0,7427	
1166	16 - 16 - 16 - 16	5	250	0,8169	
1163	20 - 20 - 20 - 20	50	500	0,7427	
1164	20 - 16 - 16 - 20	50	500	0,7427	

Ref.	Ø (mm - ")			€	Dimensiones A-B-C
1261	1/2 - 16 - 16 - 16	100	1.000	0,7089	
1266	1/2 - 16 - 16 - 16	5	500	0,7799	
1262	1/2 - 20 - 20 - 20	100	1.000	0,7089	
1263	1/2 - 16 - 16 - 20	100	1.000	0,7089	



**ENLACE COMPRESION  
COMPRESSION UNION  
RACCORD PAR COMPRESION  
UNIAO COMPRESAO**

Ref.	Ø (mm)			€	Dimensiones A-B-C
2811	16	50	1.000	0,6112	
2812	20	50	500	0,9000	
2813	25	50	500	1,1400	



**ENLACE COMPRESION - CINTA SUPERROSCADA  
COMPRESSION UNION - SUPER-THREADED TAPE UNION  
RACCORD PAR COMPRESION - TUYAU PLAT SUPERROSCADA  
UNIAO COMPRESAO - FITA SUPERROSCADA**

Ref.	Ø (mm)			€	Dimensiones A-B-C
2821	16	50	1.000	0,7128	



**TOMA GRAN CAUDAL COMPRESION  
COMPRESSION GREAT FLOW INTAKE  
DÉPART GRAND DEBIT COMPRESION  
TOMA GRAN CAUDAL COMPRESAO**

Ref.	Ø (mm)			€	Dimensiones A-B-C
2831	16	100	1.000	0,4585	



**UNION ROSCA MACHO COMPRESION  
MALE THREADED COMPRESSION UNION  
RACCORD COMPRESION MALE FILETÉ  
UNIAO RM COMPRESAO**

Ref.	Ø (mm)			€	Dimensiones A-B-C
2841	16	100	1.000	0,4585	



**CODO COMPRESION  
COMPRESSION ELBOW  
COUDE COMPRESION  
JOELHO COMPRESAO**

Ref.	Ø (mm)			€	Dimensiones A-B-C
2861	16	25	500	1,0502	



**TE COMPRESION  
COMPRESSION TEE  
TE COMPRESION  
TE COMPRESAO**

Ref.	Ø (mm)			€	Dimensiones A-B-C
2871	16	25	500	1,3497	
2881	16	25	500	1,3497	
2882	16	25	500	1,3497	





## ENLACE CINTA SUPERROSCADA SUPER-THREADED TAPE UNION

RACCORD PAR SUPER-FILETE TUYAU PLAT  
UNIAO FITA SUPERROSCADA

## ENLACE CINTA SUPERROSCADA - MANGUERA SUPER-THREADED TAPE UNION - HOSE UNION

RACCORD PAR TUYAU - TUYAU PLAT SUPERROSCADA  
UNIAO MANGUEIRA - FITA SUPERROSCADA

Ref.	Ø (mm)			€	Dimensiones A-B-C
2711	16	50	1.000	0,4914	

Ref.	Ø (mm)			€	Dimensiones A-B-C
2721	16	100	1.000	0,4098	







## TOMA GRAN CAUDAL CINTA SUPERROSCADA SUPER-THREADED TAPE UNION GREAT FLOW INTAKE

DÉPART GRAND DEBIT SUPER-FILETE TUYAU PLAT  
TOMA GRAN CAUDAL FITA SUPERROSCADA

## UNION ROSCA MACHO CINTA SUPERROSCADA MALE THREADED SUPER-THREADED TAPE UNION

RACCORD SUPER-FILETÉ TUYAU PLAT MALE FILETÉ  
UNIAO RM FITA SUPERROSCADA

Ref.	Ø (mm)			€	Dimensiones A-B-C
2731	16	100	1.000	0,4098	

Ref.	Ø (mm)			€	Dimensiones A-B-C
2741	16	100	1.000	0,4098	





## CODO CINTA SUPERROSCADA SUPER-THREADED TAPE UNION ELBOW

COUDE SUPER-FILETE TUYAU PLAT  
JOELHO FITA SUPERROSCADA

## TE CINTA SUPERROSCADA SUPER-THREADED TAPE UNION TEE

TE SUPER-FILETE TUYAU PLAT  
TE FITA SUPERROSCADA

Ref.	Ø (mm)			€	Dimensiones A-B-C
2761	16	25	500	0,9547	

Ref.	Ø (mm)			€	Dimensiones A-B-C
2771	16	25	500	0,9547	
2781	16	25	500	0,9547	
2782	16	25	500	0,9547	



### UNIÓN CINTA EXTRA

Ideal para extraer ramales desde una tubería de Layflat. Tras hacer el agujero, introducir la lengüeta, sujetar con la mano a través de la manguera. Enroscar la tuerca y queda fija

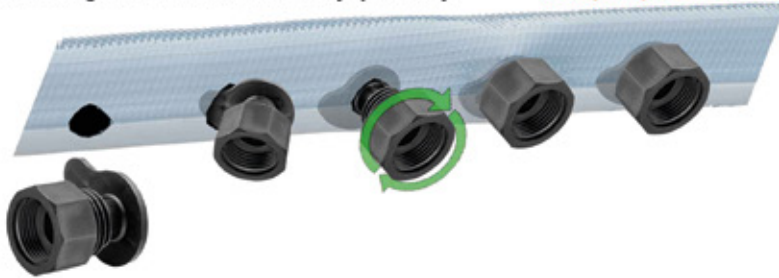

### LAYFLAT UNION

Ideal for branches from Layflat. After making the hole to enter the tab. Hold with hand through the layflat piece. Screw the threaded and its fixed.

### UNIÓN CINTA EXTRA

Idóneo para unir cintas a un bajo coste. La espiral interna de la anilla mejora la sujeción.



### EXTRA TAPE UNIÓN

ideal for joining low cost tapes. The internal spiral of the ring improves the grip.

### UNIÓN CINTA ROSCADA

Gran sujeción, la tuerca compresiona a la cinta con el exterior del cuerpo de la unión.

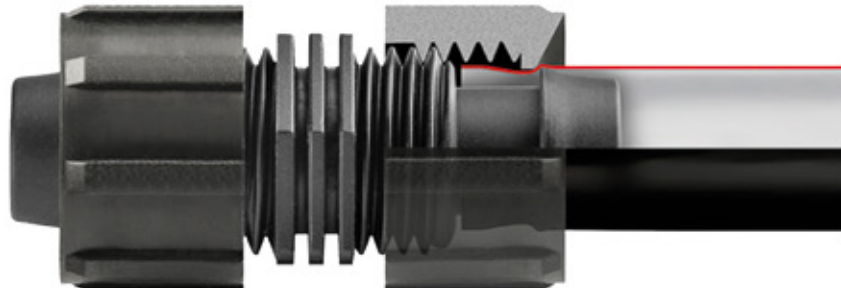

### THREADED TAPE UNION

Great grip, the nut compresses the tape on the body.

### UNIÓN CINTA MEGAROSCADA

El mega-recorrido de la rosca, proporciona mayor presión de la cinta sobre el cuerpo del enlace

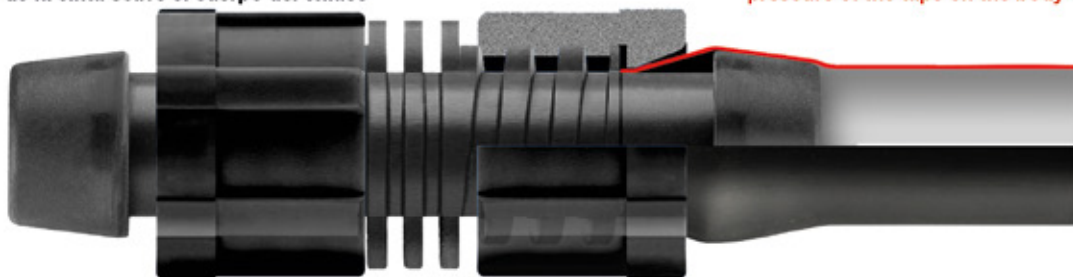

### MEGA-THREADED TAPE UNION

The mega-stroke of the thread, provides greater pressure of the tape on the body of de link

### UNIÓN SUPERROSCADA

Sujección máxima, la tuerca compresiona a la cinta con el cuerpo de la unión.

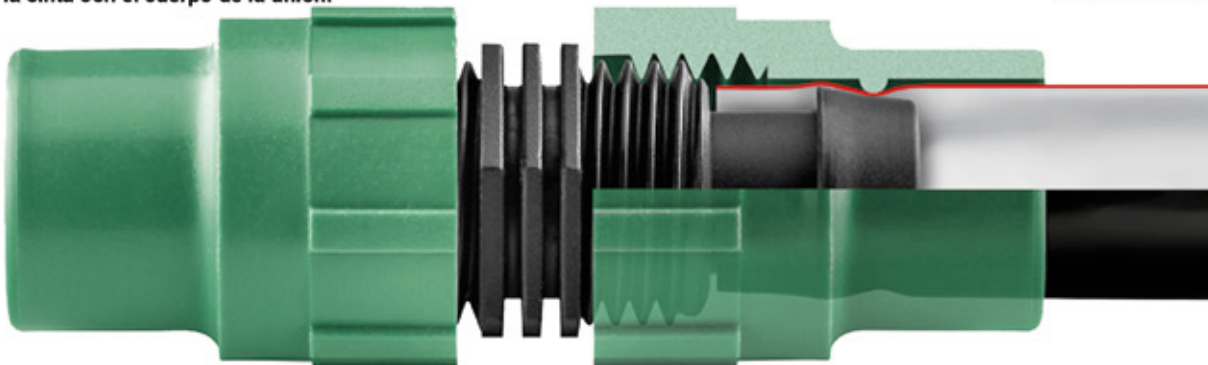

### SUPER-THREADED UNION

Maximum fixing. The thread presses the tape with de union body



**"Y" ACETAL MANGUERA 2 SALIDAS A CINTA ROSCADA**  
ACETAL "Y" HOSE UNION - 2 OUTPUTS THREADED UNION

"Y" EN ACETAL TUYAU - 2 RACCORDS FILETÉ TUYAU PLAT

"Y" ACETAL MANGUEIRA 2 SAIDAS A FITA ROSCADA



Ref.	Ø (mm)			€	Dimensiones A-B-C
3161	16 / 16 - 16	50	500	0,9302	
3162	20 / 16 - 16	50	500	0,9302	



**"Y" ACETAL MANGUERA 2 SALIDAS A CINTA EXTRA**  
ACETAL "Y" HOSE UNION - 2 OUTPUTS EXTRA UNION

"Y" EN ACETAL TUYAU - 2 RACCORDS EXTRA TUYAU PLAT

"Y" ACETAL MANGUEIRA 2 SAIDAS A FITA EXTRA



Ref.	Ø (mm)			€	Dimensiones A-B-C
3171	16 / 16 - 16 - 16	50	500	0,7653	
3172	20 / 16 - 16 - 16	50	500	0,7653	



**"Y" ACETAL TOMA GRAN CAUDAL 2 SALIDAS A CINTA ROSCADA**  
ACETAL "Y" GREAT FLOW INTAKE- 2 OUTPUTS THREADED UNION

"Y" EN ACETAL DEPART GRAND DEBIT - 2 RACCORDS FILETÉ TUYAU PLAT

"Y" ACETAL TOMA GRAN CAUDAL 2 SAIDAS A FITA ROSCADA



Ref.	Ø (mm)			€	Dimensiones A-B-C
3163	16	50	500	0,9302	



**"Y" ACETAL TOMA GRAN CAUDAL 2 SALIDAS A CINTA EXTRA**  
ACETAL "Y" GREAT FLOW INTAKE- 2 OUTPUTS EXTRA UNION

"Y" EN ACETAL DEPART GRAND DEBIT - 2 RACCORDS EXTRA TUYAU PLAT

"Y" ACETAL TOMA GRAN CAUDAL 2 SAIDAS A FITA EXTRA



Ref.	Ø (mm)			€	Dimensiones A-B-C
3173	16	50	500	0,7653	



**"Y" ACETAL ROSCA MACHO 2 SALIDAS A CINTA ROSCADA**  
ACETAL "Y" MALE THREADED - 2 OUTPUTS THREADED UNION

"Y" EN ACETAL MALE FILETÉ- 2 RACCORDS FILETÉ TUYAU PLAT

"Y" ACETAL RM 2 SAIDAS A FITA ROSCADA

Ref.	Ø (" - mm)			€	Dimensiones A-B-C
3164	1/2 / 16 - 16	50	500	0,9302	



**"Y" ACETAL ROSCA MACHO 2 SALIDAS A CINTA EXTRA**  
ACETAL "Y" MALE THREADED - 2 OUTPUTS EXTRA UNION

"Y" EN ACETAL MALE FILETÉ- 2 RACCORDS EXTRA TUYAU PLAT

"Y" ACETAL RM 2 SAIDAS A FITA EXTRA

Ref.	Ø (" - mm)			€	Dimensiones A-B-C
3174	1/2 / 16 - 16 - 16	50	500	0,7653	



**ENLACE CINTA EXTRA ACETAL**  
**EXTRA TAPE UNION**  
**RACCORD TUYAU PLAT EXTRA**  
**UNIAO FITA EXTRA**

Ref.	Ø (mm)			€	Dimensiones A-B-C
3111	16	100	2.000	0,2016	
3113	22	50	500	0,5250	

**ENLACE CINTA EXTRA - MANGUERA**  
**EXTRA TAPE UNION - HOSE UNION**  
**RACCORD PAR TUYAU PLAT EXTRA - TUYAU**  
**UNIAO FITA EXTRA - MANGUEIRA**

Ref.	Ø (mm - mm)			€	Dimensiones A-B-C
3121	16	100	2.000	0,1764	
3123	22 - 20	50	500	0,4830	



**TOMA GRAN CAUDAL CINTA EXTRA**  
**EXTRA TAPE UNION GREAT FLOW INTAKE**  
**DÉPART GRAND DEBIT EXTRA TUYAU PLAT**  
**TOMA GRAN CAUDAL FITA EXTRA**

Ref.	Ø (mm)			€	Dimensiones A-B-C
3131	16	100	2.000	0,1764	
3133	22	50	500	0,4830	



**CODO CINTA EXTRA**  
**EXTRA TAPE UNION ELBOW**  
**COUDE EXTRA TUYAU PLAT**  
**JOELHO FITA EXTRA**

Ref.	Ø (")			€	Dimensiones A-B-C
3141	16	50	1.000	0,6720	







**TE CINTA EXTRA**  
**EXTRA TAPE UNION TEE**  
**TE EXTRA TUYAU PLAT**  
**TE FITA EXTRA**

Ref.	Ø (")			€	Dimensiones A-B-C
3151	16	50	1.000	0,7140	





**TE CINTA EXTRA (ROSCA M./TOMA)**  
**EXTRA TAPE UNION TEE (THREADED/INTAKE)**  
**TE EXTRA TUYAU PLAT (FILETÉ/DEPART)**  
**TE FITA EXTRA (RM/TOMA)**

Ref.	Ø (\" - mm)			€	Dimensiones A-B-C
3155	1/2 - 16	50	1.000	0,7140	
3157	16	50	1.000	0,7140	





**CODO CINTA EXTRA (ROSCA M./TOMA)**  
**EXTRA TAPE UNION ELBOW (THREADED/INTAKE)**  
**COUDE EXTRA TUYAU PLAT (FILETÉ/DEPART)**  
**JOELHO FITA EXTRA (RM/TOMA)**

Ref.	Ø (\" - mm)			€	Dimensiones A-B-C
3145	1/2 - 16	50	1.000	0,6720	
3147	16	50	1.000	0,6720	



**UNION ROSCA MACHO CINTA ROSCADA**  
**MALE THREADED THREADED TAPE UNION**  
**RACCORD FILETÉ TUYAU PLAT MALE FILETÉ**  
**UNIAO RM FITA ROSCADA**

Ref.	Ø (\" - mm)			€	Dimensiones A-B-C
1561	1/2 - 16	100	1.000	0,3999	



**ENLACE CINTA ROSCADA**  
**THREADED TAPE UNION**

**RACCORD PAR FILETE TUYAU PLAT**  
**UNIAO FITA ROSCADA**

Ref.	Ø (mm)			€	Dimensiones A-B-C
<b>1471</b>	16	50	1.000	<b>0,4709</b>	



**ENLACE CINTA ROSCADA - MANGUERA**  
**THREADED TAPE UNION - HOSE UNION**

**RACCORD PAR FILETÉ TUYAU PLAT - TUYAU**  
**UNIAO MANGUEIRA - FITA ROSCADA**

Ref.	Ø (mm)			€	Dimensiones A-B-C
<b>1491</b>	16	100	1.000	<b>0,3927</b>	



**TOMA GRAN CAUDAL CINTA ROSCADA**  
**THREADED TAPE UNION GREAT FLOW INTAKE**

**DÉPART GRAND DÉBIT FILETE TUYAU PLAT**  
**TOMA GRAN CAUDAL FITA ROSCADA**

Ref.	Ø (mm)			€	Dimensiones A-B-C
<b>1481</b>	16	100	1.000	<b>0,3927</b>	



**CODO CINTA ROSCADA**  
**THREADED TAPE UNION ELBOW**

**COUDE FILETE TUYAU PLAT**  
**JOELHO FITA ROSCADA**

Ref.	Ø (mm)			€	Dimensiones A-B-C
<b>1571</b>	16	25	500	<b>0,9149</b>	
<b>N 1575</b>	1/2 - 16	25	500	<b>0,9149</b>	
<b>N 1577</b>	16	25	500	<b>0,9149</b>	



**ENLACE CINTA MEGAROSCADA**  
**MEGA-THREADED TAPE UNION**  
RACCORD PAR MEGA-FILETE TUYAU PLAT  
UNIAO FITA MEGAROSCADA

**ENLACE CINTA MEGAROSCADA - MANGUERA**  
**MEGA-THREADED TAPE UNION - HOSE UNION**  
RACCORD PAR MEGA-FILETÉ TUYAU PLAT - TUYAU  
UNIAO MANGUEIRA - FITA MEGAROSCADA

Ref.	Ø (mm)			€	Dimensiones A-B-C
3311	16	50	1.000	0,4504	

Ref.	Ø (mm)			€	Dimensiones A-B-C
3321	16	100	1.000	0,3756	



**TE CINTA ROSCADA**  
**THREADED TAPE UNION TEE**  
TE FILETE TUYAU PLAT  
TE FITA ROSCADA

**TOMA GRAN CAUDAL CINTA MEGAROSCADA**  
**MEGA-THREADED TAPE UNION GREAT FLOW INTAKE**  
DÉPART GRAND DEBIT MEGA-FILETE TUYAU PLAT  
TOMA GRAN CAUDAL FITA MEGAROSCADA

Ref.	Ø (mm)			€	Dimensiones A-B-C
1581	16	25	500	1,1759	
N 1585	16 - 1/2	25	500	1,1759	
N 1587	16	25	500	1,1759	

Ref.	Ø (mm)			€	Dimensiones A-B-C
3331	16	100	1.000	0,3756	



- 8 435277 935113
- 8 435277 935137
- 8 435277 935144
- 8 435277 935151
- 8 435277 935212
- 8 435277 935229
- 8 435277 935236
- 8 435277 935243
- 8 435277 935250
- 8 435277 935311
- 8 435277 935328
- 8 435277 935335
- 8 435277 935342
- 8 435277 935359
- 8 435277 935618
- 8 435277 935625
- 8 435277 935632
- 8 435277 935649
- 8 435277 935656

**AMPLIACIÓN**  
**NEW MEASURES**



**ENLACE LAYFLAT**  
**LAYFLAT UNION**

**RACCORD PAR LAYFLAT**  
**UNIAO LAYFLAT**

Ref.	Ø (mm)			€	Dimensiones A-B-C
<b>3511</b>	55	-	150	<b>4,6200</b>	
<b>3512</b>	63	-	100	<b>5,7200</b>	
<b>3213</b>	77	-	100	<b>9,0200</b>	
<b>3514</b>	102	-	50	<b>10,7800</b>	
<b>A 3515</b>	127	-	10	<b>20,0000</b>	

**AMPLIACIÓN**  
**NEW MEASURES**



**UNION ROSCA MACHO LAYFLAT**  
**MALE THREADED LAYFLAT UNION**

**RACCORD LAYFLAT MALE FILETÉ**  
**UNIAO RM LAYFLAT**

Ref.	Ø (mm - ")			€	Dimensiones A-B-C
<b>3521</b>	55 - 1 1/2	-	150	<b>4,6200</b>	
<b>3522</b>	63 - 2	-	100	<b>5,7200</b>	
<b>3223</b>	77 - 2 1/2	-	100	<b>9,0200</b>	
<b>3524</b>	102 - 3	-	50	<b>10,7800</b>	
<b>A 3525</b>	127 - 4	-	10	<b>20,0000</b>	

**AMPLIACIÓN**  
**NEW MEASURES**



**TAPON LAYFLAT**  
**LAYFLAT PLUG**

**BOUCHON POUR LAYFLAT**  
**TACO LAYFLAT**

Ref.	Ø (mm)			€	Dimensiones A-B-C
<b>3531</b>	55	-	150	<b>4,6200</b>	
<b>3532</b>	63	-	100	<b>5,7200</b>	
<b>3233</b>	77	-	100	<b>9,0200</b>	
<b>3534</b>	102	-	50	<b>10,7800</b>	
<b>A 3535</b>	127	-	15	<b>20,0000</b>	

**AMPLIACIÓN**  
**NEW MEASURES**



**CODO LAYFLAT**  
**LAYFLAT ELBOW**

**COUDE POUR LAYFLAT**  
**JOELHO LAYFLAT**

Ref.	Ø (mm)			€	Dimensiones A-B-C
<b>3561</b>	55	-	100	<b>6,6000</b>	
<b>3562</b>	63	-	50	<b>7,7000</b>	
<b>3263</b>	77	-	50	<b>8,8000</b>	
<b>3564</b>	102	-	25	<b>11,0000</b>	
<b>A 3565</b>	127	-	10	<b>35,0000</b>	

**AMPLIACIÓN**  
**NEW MEASURES**



**TE LAYFLAT**  
**LAYFLAT TEE**  
**TE POUR LAYFLAT**  
**TE LAYFLAT**

Ref.	Ø (mm)			€	Dimensiones A-B-C
<b>3541</b>	55	-	100	<b>7,92000</b>	
<b>3542</b>	63	-	50	<b>9,0100</b>	
<b>3243</b>	77	-	50	<b>10,1200</b>	
<b>3544</b>	102	-	25	<b>14,0800</b>	
<b>A 3545</b>	127	-	10	<b>35,0000</b>	

**AMPLIACIÓN**  
**NEW MEASURES**



**TE LAYFLAT ROSCA MACHO**  
**LAYFLAT MALE THREADED TEE**  
**TE FILETÉ POUR LAYFLAT**  
**TE RM LAYFLAT**

Ref.	Ø (mm - ")			€	Dimensiones A-B-C
<b>3551</b>	55 - 1 1/2	-	100	<b>9,0200</b>	
<b>3552</b>	63 - 2	-	50	<b>9,9000</b>	
<b>3253</b>	77 - 2 1/2	-	50	<b>11,000</b>	
<b>3554</b>	102 - 3	-	25	<b>15,4000</b>	
<b>A 3555</b>	127 - 4	-	10	<b>35,0000</b>	

- 8 435277 935410
- 8 435277 935427
- 8 435277 935434
- 8 435277 935441
- 8 435277 935458
- 8 435277 935519
- 8 435277 935526
- 8 435277 935533
- 8 435277 935540
- 8 435277 935557
- 8 435277 935717
- 8 435277 935724
- 8 435277 935731
- 8 435277 935748
- 8 435277 935755

**AMPLIACIÓN**  
**NEW MEASURES**



**CODO LAYFLAT ROSCA MACHO**  
**LAYFLAT MALE THREADED ELBOW**  
**COUDE FILETÉ POUR LAYFLAT**  
**JOELHO RM LAYFLAT**

Ref.	Ø (mm - ")			€	Dimensiones A-B-C
<b>3571</b>	55 - 1 1/2	-	100	<b>7,7000</b>	
<b>3572</b>	63 - 2	-	50	<b>8,8000</b>	
<b>3273</b>	77 - 2 1/2	-	50	<b>9,9000</b>	
<b>3574</b>	102 - 3	-	25	<b>12,1000</b>	
<b>A 3575</b>	127 - 4	-	10	<b>35,0000</b>	

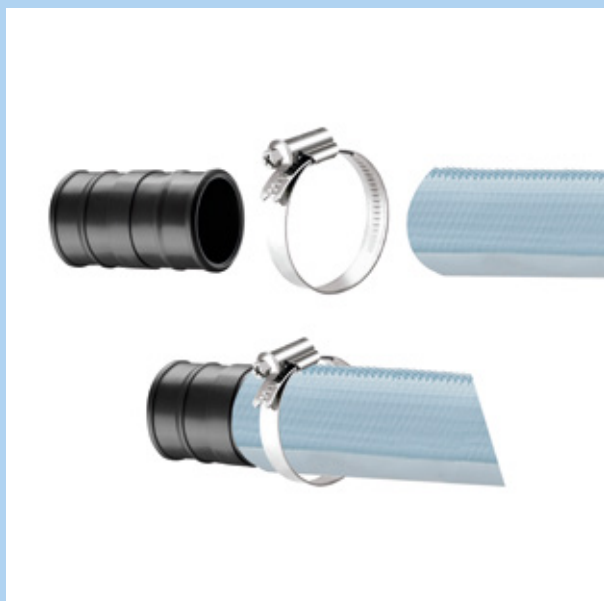

**Ejemplo de utilización**  
*Example of use*



8 435277 915313



8 435277 915337



8 435277 915412



8 435277 915450



**TOMA LAYFLAT MANGUERA**  
**LAYFLAT INTAKE FOR HOSE**  
**DÉPART LAYFLAT POUR TUYAU**  
**UNIAO LAYFLAT MANGUEIRA**

Ref.	Ø (mm)			€	Dimensiones A-B-C
1541	16	100	1.000	0,6380	



**TOMA LAYFLAT CINTA**  
**LAYFLAT INTAKE FOR TAPE**  
**DÉPART LAYFLAT POUR TUYAU PLAT**  
**UNIAO LAYFLAT FITA**

Ref.	Ø (mm)			€	Dimensiones A-B-C
1531	16	50	1.000	0,6380	Superroscada
1533	16	50	1.000	0,9680	Extra



**TOMA LAYFLAT ROSCA HEMBRA**  
**LAYFLAT INTAKE FOR MALE THREADED**  
**DÉPART LAYFLAT POUR MALE THREADED**  
**UNIAO LAYFLAT PARA RM**

Ref.	Ø (")			€	Dimensiones A-B-C
1545	1/2	100	1.000	0,6380	

**Ejemplo de montaje**  
Assembly example

**Ejemplo de combinaciones**  
Combinations example

- + **3155**
- + **3021**
- + **3174**





## LLAVES CLIPADAS PRESSED VALVES



- ✓ **Cuerpo fabricado en Acetal (Mayor resistencia)**  
*Body made of Acetal (High resistance)*



## LLAVES TOTAL TOTAL VALVES

- ✓ **Sistema de fijación en golpes de ariete**  
*No leak system*



- ✓ **Alta estanqueidad (2 Juntas toricas)**  
*High tightness (2 O-rings)*

## LLAVES EXTRA EXTRA VALVES



- ✓ **Sistema de fijación en golpes de ariete**  
*No leak system*

- ✓ **Maxima estanqueidad (4 Juntas toricas)**  
*Maximum tightness (4 O-rings)*



IRRIGATION

RIEGO



8 435277 917119



8 435277 917126



8 435277 917164



8 435277 918116



8 435277 918130



8 435277 918161



8 435277 918413



**LLAVE TOTAL COMPRESION**  
**COMPRESSION TOTAL VALVE**  
**VANNE TOTAL DE COMPRESSION**  
**VALVULA TOTAL COMPRESSAO**

Ref.	Ø (mm)			€	Dimensiones A-B-C
1841	16	50	700	1,3703	



**LLAVE TOTAL COMPRESION - ROSCA MACHO**  
**COMPRESSION TOTAL VALVE - MALE THREADED**  
**VANNE TOTAL DE COMPRESSION - FILETÉ**  
**VALVULA TOTAL COMPRESSAO - RM**

Ref.	Ø (" - mm)			€	Dimensiones A-B-C
1746	1/2 - 16	50	700	1,2355	



**LLAVE TOTAL COMPRESION - TOMA GRAN CAUDAL**  
**COMPRESSION TOTAL VALVE - GREAT FLOW INTAKE**  
**VANNE TOTAL DE COMPRESSION - DEPART GRAND DEBIT**  
**VALVULA TOTAL COMPRESSAO - TOMA GRAN CAUDAL**

Ref.	Ø (mm)			€	Dimensiones A-B-C
1851	16	50	700	1,2355	



**LLAVE TOTAL SIMPLE**  
**SIMPLE TOTAL VALVE**  
**VANNE TOTAL SIMPLE**  
**VALVULA TOTAL SIMPLE**

**LLAVE TOTAL SEGURIDAD**  
**TOTAL VALVE WITH SAFETY RING**  
**VANNE TOTAL DE SÉCURITÉ**  
**VALVULA TOTAL SEGURANÇA**

Ref.	Ø (mm)			€	Dimensiones A-B-C
1710	12	100	1.000	0,8761	
1711	16	100	1.000	0,7502	
1716	16	5	500	0,9439	
1712	18	100	1.000	0,9508	

Ref.	Ø (mm)			€	Dimensiones A-B-C
1810	12	100	1.000	0,9712	
1811	16	100	1.000	1,0153	
1816	16	5	500	1,1170	
1813	20	50	1.000	1,1036	



**LLAVE TOTAL SIMPLE - TOMA GRAN CAUDAL**  
**SIMPLE TOTAL VALVE - GREAT FLOW INTAKE**  
**VANNE TOTAL SIMPLE - DEPART GRAND DEBIT**  
**VALVULA TOTAL SIMPLE - TOMA GRAN CAUDAL**

**LLAVE TOTAL SIMPLE - ROSCA MACHO**  
**SIMPLE TOTAL VALVE - MALE THREADED**  
**VANNE TOTAL SIMPLE - FILETÉ**  
**VALVULA TOTAL SIMPLE - RM**

Ref.	Ø (mm)			€	Dimensiones A-B-C
1761	16	100	1.000	0,9815	
1762	18	100	1.000	0,9815	

Ref.	Ø (" - mm)			€	Dimensiones A-B-C
1751	1/2 - 16	100	1.000	0,9815	





8 435277 917263



8 435277 917362



8 435277 917713



8 435277 917812



8 435277 917911



8 435277 918611



8 435277 918710



8 435277 918819



1771

1861

**LLAVE TOTAL CINTA**  
**TOTAL VALVE FOR TAPE**  
**VANNE TOTAL POUR TUYAU PLAT**  
**VALVULA TOTAL FITA**

Ref.	Ø (mm)			€	Dimensiones A-B-C
1771	16	50	700	1,2458	Roscada
1861	16	50	700	1,2458	Superroscada



1726

1736

**LLAVE TOTAL CINTA - ROSCA MACHO**  
**TOTAL VALVE FOR TAPE - MALE THREADED**  
**VANNE TOTAL DE POUR TUYAU PLAT - FILETÉ**  
**VALVULA TOTAL FITA - RM**

Ref.	Ø (" - mm)			€	Dimensiones A-B-C
1726	1/2 - 16	50	700	1,1232	Roscada
1736	1/2 - 16	50	700	1,1232	Superroscada



1781

1881

**LLAVE TOTAL CINTA - MANGUERA**  
**TOTAL VALVE FOR TAPE - HOSE**  
**VANNE TOTAL POUR TUYAU PLAT - TUYAU**  
**VALVULA TOTAL FITA - MANGUEIRA**

Ref.	Ø (mm)			€	Dimensiones A-B-C
1781	16	50	700	1,1232	Roscada
1881	16	50	700	1,1232	Superroscada



1792



1871

**LLAVE TOTAL CINTA - TOMA GRAN CAUDAL**  
**TOTAL VALVE FOR TAPE - GREAT FLOW INTAKE**  
**VANNE TOTAL POUR TUYAU PLAT - DEPART GRAND DEBIT**  
**VALVULA TOTAL FITA - TOMA GRAN CAUDAL**

Ref.	Ø (mm)			€	Dimensiones A-B-C
1791	16	50	700	1,1232	Roscada
1871	16	50	700	1,1232	Superroscada



**LLAVE CLIPADA ACETAL**  
**ACETAL PRESSED VALVE**  
**VANNE PRESSEE EN ACETAL**  
**VALVULA PRESIONADA ACETAL**

Ref.	Ø (mm)			€	Dimensiones A-B-C
N 2061	16	50	700	0,5797	
N 2062	20	50	700	0,5797	



**LLAVE CLIPADA - TOMA GRAN CAUDAL ACETAL**  
**ACETAL PRESSED VALVE - GREAT FLOW INTAKE**  
**VANNE PRESEE - DEPART GRAND DEBIT EN ACETAL**  
**VALVULA PRESIONADA - TOMA GRAN CAUDAL ACETAL**

Ref.	Ø (" - mm)			€	Dimensiones A-B-C
N 2071	16	50	700	0,5797	
N 2072	20	50	700	0,5797	



**LLAVE CLIPADA - ROSCA MACHO ACETAL**  
**ACETAL PRESSED VALVE - MALE THREADED**  
**VANNE PRESEE - FILETÉ EN ACETAL**  
**VALVULA PRESIONADA - RM ACETAL**

Ref.	Ø (mm ")			€	Dimensiones A-B-C
N 2081	16 - 1/2	50	700	0,6376	
N 2082	20 - 1/2	50	700	0,6376	
N 2083	16 - 3/4	50	700	0,6376	
N 2084	20 - 3/4	50	700	0,6376	



**NEW**

**LLAVE CLIPADA CINTA EXTRA EN ACETAL**  
**ACETAL PRESSED VALVE FOR EXTRA TAPE**  
**VANNE PRESSEE POUR TUYAU PLAT EXTRA ACETAL**  
**VALVULA PRESIONADA FITA EXTRA ACETAL**

Ref.	Ø (mm)			€	Dimensiones A-B-C
1951	16	50	700	1,1326	
1952	22	50	700	1,4200	



**NEW**

**LLAVE CLIPADA CINTA EXTRA - MANGUERA ACETAL**  
**ACETAL PRESSED VALVE FOR EXTRA TAPE - HOSE**  
**VANNE PRESSEE POUR TUYAU PLAT EXTRA - TUYAU EN ACETAL**  
**VALVULA PRESIONADA FITA EXTRA - MANGUEIRA ACETAL**

Ref.	Ø (mm - mm)			€	Dimensiones A-B-C
1961	16 - 16	50	700	0,9800	
1962	22 - 20	50	700	1,4200	



**NEW**

**LLAVE CLIPADA CINTA EXTRA - TOMA GRAN CAUDAL ACETAL**  
**ACETAL PRESSED VALVE FOR EXTRA TAPE - GREAT FLOW INTAKE**  
**VANNE PRESSEE POUR TUYAU PLAT EXTRA - GRAND DEBIT EN ACETAL**  
**VALVULA PRESIONADA FITA EXTRA - TOMA GRAN CAUDAL ACETAL**

Ref.	Ø (mm)			€	Dimensiones A-B-C
1971	16	50	700	0,9800	
1972	20	50	700	1,4200	



**NEW**

**LLAVE CLIPADA CINTA EXTRA - ROSCA MACHO ACETAL**  
**ACETAL PRESSED VALVE FOR EXTRA TAPE - MALE THREADED**  
**VANNE PRESSEE POUR TUYAU PLAT EXTRA - FILETÉ EN ACETAL**  
**VALVULA PRESIONADA FITA EXTRA - RM ACETAL**

Ref.	Ø (" - mm)			€	Dimensiones A-B-C
1981	1/2 - 16	50	700	0,9800	
1982	1/2 - 20	50	700	1,4200	
1983	3/4 - 16	50	700	0,9800	
1984	3/4 - 20	50	700	1,4200	





**LLAVE EXTRA CINTA MEGAROSCADA**  
EXTRA VALVE FOR MEGA-THREADED TAPE  
VANNE EXTRA POUR TUYAU PLAT MEGA-FILETÉ  
VALVULA EXTRA FITA MEGAROSCADA

**LLAVE EXTRA CINTA MEGAROSCADA - MANGUERA**  
EXTRA VALVE FOR MEGA-THREADED TAPE - HOSE  
VANNE EXTRA POUR TUYAU PLAT MEGA-FILETÉ - TUYAU  
VALVULA EXTRA FITA MEGAROSCADA - MANGUEIRA

Ref.	Ø (mm)			€	Dimensiones A-B-C
3410	16	50	700	1,2458	
3411	16	50	700	1,2458	
3412	16	50	700	1,2458	
3413	16	50	700	1,2458	

Ref.	Ø (mm)			€	Dimensiones A-B-C
3420	16	50	700	1,1232	
3421	16	50	700	1,1232	
3422	16	50	700	1,1232	
3423	16	50	700	1,1232	



**LLAVE EXTRA CINTA MEGAROSCADA - TOMA GRAN CAUDAL**  
EXTRA VALVE FOR MEGA-THREADED TAPE - GREAT FLOW INTAKE  
VANNE EXTRA POUR TUYAU PLAT MEGA-FILETÉ - DEPART GRAND DEBIT  
VALVULA EXTRA FITA MEGAROSCADA - TOMA GRAN CAUDAL

**LLAVE EXTRA CINTA MEGAROSCADA - ROSCA MACHO**  
EXTRA VALVE FOR MEGA-THREADED TAPE - MALE THREADED  
VANNE EXTRA POUR TUYAU PLAT MEGA-FILETÉ - FILETÉ  
VALVULA EXTRA FITA MEGAROSCADA - RM

Ref.	Ø (mm)			€	Dimensiones A-B-C
3430	16	50	700	1,1232	
3431	16	50	700	1,1232	
3432	16	50	700	1,1232	
3433	16	50	700	1,1232	

Ref.	Ø (" - mm)			€	Dimensiones A-B-C
3440	1/2 - 16	50	700	1,1232	
3441	1/2 - 16	50	700	1,1232	
3442	1/2 - 16	50	700	1,1232	
3443	1/2 - 16	50	700	1,1232	

- 8 435277 934109
- 8 435277 934116
- 8 435277 934123
- 8 435277 934130
- 8 435277 934208
- 8 435277 934215
- 8 435277 934222
- 8 435277 934239
- 8 435277 934307
- 8 435277 934314
- 8 435277 934321
- 8 435277 934338
- 8 435277 934406
- 8 435277 934413
- 8 435277 934420
- 8 435277 934437



## LLAVE EXTRA CINTA ROSCADA EXTRA VALVE FOR THREADED TAPE VANNE EXTRA POUR TUYAU PLAT FILETÉ VALVULA EXTRA FITA ROSCADA

Ref.	Ø (mm)			€	Dimensiones A-B-C
2955	16	50	700	1,2458	
2965	16	50	700	1,2458	
2975	16	50	700	1,2458	
2985	16	50	700	1,2458	



## LLAVE EXTRA CINTA ROSCADA - MANGUERA EXTRA VALVE FOR THREADED TAPE - HOSE VANNE EXTRA POUR TUYAU PLAT FILETÉ - TUYAU VALVULA EXTRA FITA ROSCADA - MANGUEIRA

Ref.	Ø (mm)			€	Dimensiones A-B-C
2957	16	50	700	1,1232	
2967	16	50	700	1,1232	
2977	16	50	700	1,1232	
2987	16	50	700	1,1232	



## LLAVE EXTRA CINTA ROSCADA - TOMA GRAN CAUDAL EXTRA VALVE FOR THREADED TAPE - GREAT FLOW INTAKE VANNE EXTRA POUR TUYAU PLAT FILETÉ - DEPART GRAND DEBIT VALVULA EXTRA FITA ROSCADA - TOMA GRAN CAUDAL

Ref.	Ø (mm)			€	Dimensiones A-B-C
2959	16	50	700	1,1232	
2969	16	50	700	1,1232	
2979	16	50	700	1,1232	
2989	16	50	700	1,1232	

## Ejemplo de utilización Example of use



\*La tuerca de fijación permite fijar la llave y evitar escapes. Una vez introducida la toma, desenroscamos la tuerca permitiendo que quede apretada contra el tubo.

\*The fixing nut allows to fix the key and avoid leaks. Once the is inserted, we unscrew the nut allowing it to be pressed against the tube.



**LLAVE EXTRA SIMPLE**  
**SIMPLE EXTRA VALVE**  
**VANNE EXTRA SIMPLE**  
**VALVULA EXTRA SIMPLE**

**LLAVE EXTRA SIMPLE - TOMA GRAN CAUDAL**  
**SIMPLE EXTRA VALVE - GREAT FLOW INTAKE**  
**VANNE EXTRA SIMPLE - DEPART GRAND DEBIT**  
**VALVULA EXTRA SIMPLE - TOMA GRAN CAUDAL**

Ref.	Ø (mm)			€	Dimensiones A-B-C
2911	16	50	1.000	0,7502	
2913	20	50	1.000	0,7502	
2915	16	50	1.000	0,9267	
2921	16	50	1.000	0,7502	
2923	20	50	1.000	0,7502	
2931	16	50	1.000	0,7502	
2933	20	50	1.000	0,7502	
2941	16	50	1.000	0,7502	
2943	20	50	1.000	0,7502	

Ref.	Ø (mm)			€	Dimensiones A-B-C
2916	16	50	1.000	0,7502	
2918	20	50	1.000	0,7502	
2926	16	50	1.000	0,7502	
2928	20	50	1.000	0,7502	
2936	16	50	1.000	0,7502	
2938	20	50	1.000	0,7502	
2946	16	50	1.000	0,7502	
2948	20	50	1.000	0,7502	



**LLAVE EXTRA CINTA MEGAROSCADA - TOMA TUERCA FIJACION**  
**EXTRA VALVE FOR MEGA-THREADED TAPE - NUT FIXING INTAKE**



**LLAVE EXTRA SIMPLE - ROSCA MACHO**  
**SIMPLE EXTRA VALVE - MALE THREADED**

*VANNE EXTRA POUR TUYAU PLAT MEGA-FILETÉ - DEPART ECROU DE FIXATION*  
*VALVULA EXTRA FITA MEGAROSCADA - TOMA PORCA FIXA*

**VANNE EXTRA SIMPLE - FILETÉ**  
**VALVULA EXTRA SIMPLE - RM**

Ref.	Ø (mm)			€	Dimensiones A-B-C
1789	16	50	700	1,2458	

Ref.	Ø (" - mm)			€	Dimensiones A-B-C
2951	1/2 - 16	50	1.000	0,9498	
2953	1/2 - 20	50	1.000	0,9498	
2961	1/2 - 16	50	1.000	0,9498	
2963	1/2 - 20	50	1.000	0,9498	
2971	1/2 - 16	50	1.000	0,9498	
2973	1/2 - 20	50	1.000	0,9498	
2981	1/2 - 16	50	1.000	0,9498	
2983	1/2 - 20	50	1.000	0,9498	







**TAPÓN ASA SIMPLE**  
**HANDLED SIMPLE PLUG**  
**BOUCHON SIMPLE AVEC ANNEAU**  
**TAMPAO ASA SIMPLES**

Ref.	Ø (mm)			€	Dimensiones A-B-C
1310	12	100	3.000	0,0631	
1311	16	100	3.000	0,0795	
1313	20	100	3.000	0,0795	



**TAPÓN ASA ACETAL**  
**HANDLED ACETAL PLUG**  
**BOUCHON ACETAL AVEC ANNEAU**  
**TAMPAO ASA ACETAL**

Ref.	Ø (mm)			€	Dimensiones A-B-C
1320	12	100	3.000	0,0715	
1321	16	100	3.000	0,0900	4 Puntas
1326	16	10	1.500	0,1079	4 Puntas



**ESTRANGULADOR FINAL**  
**END LINE CHOKE**  
**ESTRANGLEURS**  
**ANEL FIM LINHA**

Ref.	Ø (mm)			€	Dimensiones A-B-C
1350	12	100	3.000	0,0631	
1351	16	100	3.000	0,0724	
1356	16	10	1.500	0,0869	
1353	20	100	1.500	0,0724	



**TAPÓN COMPRESIÓN**  
**COMPRESION PLUG**  
**BOUCHON COMPRESSION**  
**TACO COMPRESSAO**

Ref.	Ø (mm)			€	Dimensiones A-B-C
2851	16	100	1.000	0,4585	



**TAPON MIXTO**  
**MIXED PLUG**  
**BOUCHON MIXTE**  
**TACO MISTO OCO**

Ref.	Ø (mm)			€	Dimensiones A-B-C
1340	12 - 15 - 16	100	3.000	0,0631	Hueco
1341	16 - 18	100	3.000	0,1735	Hueco
1343	12 - 15 - 16	100	3.000	0,0768	Macizo
1344	16 - 18	100	3.000	0,2083	Macizo

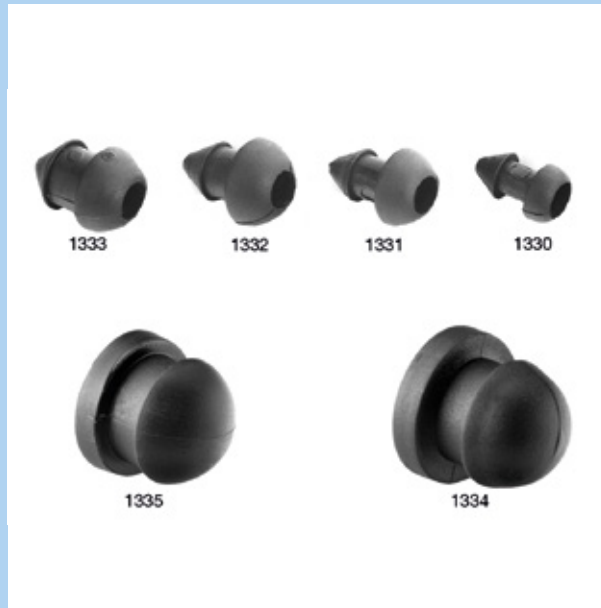

**TAPON PINCHADO CON AGUJERO**  
**INSERTED PLUGS WITH AN ORIFICE**  
**BOUCHON PERFORE**  
**TACO POR ORIFICIOS**

Ref.	Ø (mm)			€	Dimensiones A-B-C
1330	3x3	1.000	10.000	0,0334	
1331	4x4	1.000	10.000	0,0334	
1332	5x5	1.000	10.000	0,0334	
1337	5x5	50	5.000	0,1053	
1333	6x6	1.000	10.000	0,0432	
1334	Toma Normal	1.000	10.000	0,0577	
1335	Toma Gran Caudal	1.000	10.000	0,0721	



**TAPON CINTA ROSCADA Y SUPERROSCADA**  
**THREADED AND SUPER-THREADED TAPE PLUG**  
**BOUCHON TUYAU PLAT FILETÉ ET SUPER-FILETÉ**  
**TACO FITA ROSCADA Y SUPER-ROSCADA**

Ref.	Ø (mm)			€	Dimensiones A-B-C
1551	16	100	1.000	0,3995	
2751	16	100	1.000	0,4168	



**TAPON CINTA MEGA-ROSCADA Y EXTRA**  
**MEGA-THREADED AND EXTRA TAPE PLUG**  
**BOUCHON TUYAU PLAT MEGA-FILETÉ ET EXTRA**  
**TACO FITA MEGAROSCADA Y EXTRA**

Ref.	Ø (mm)			€	Dimensiones A-B-C
3181	16	100	1.000	0,1764	Extra
3183	22	50	1.000	0,4830	Extra
3381	16	100	1.000	0,3821	Megaroscada



8 435277 921123



8 435277 921178



8 435277 921406



8 435277 921413



8 435277 921468



8 435277 921505



8 435277 921512



8 435277 921604



8 435277 921611



8 435277 921635



**GOTERO REGULABLE**  
**ADJUSTABLE DRIPPER**  
**GOUTTEUR REGLABLE**  
**GOTEJADOR REGULAVEL CRAVAR**

Ref.	Cap (l/h)			€	Dimensiones A-B-C
2112	0-6	500	10.000	0,0820	
2117	0-6	25	5.000	0,0980	



**GOTERO LAGO**  
**DRIPPER LAGO**  
**GOUTTEUR LAGO**  
**GOTEJADOR PINCHADO LAGO**

Ref.	Cap (l/h)			€	Dimensiones A-B-C
2140	5	200	4.000	0,1365	
2141	5	200	4.000	0,2013	Interlinea
2146	5	25	2.000	0,2416	Interlinea



**GOTERO INTERLINEA**  
**INTERLINEAL DRIPPER**  
**GOUTTEUR INTERLIGNE**  
**GOTEJADOR INTERLINHA**

Ref.	Cap (l/h)			€	Dimensiones A-B-C
2160	12	100	5.000	0,0471	
2161	16	100	2.500	0,0727	
2163	-	-	1.000	0,2475	



**GOTERO LANZA MIXTA**  
**MIX SPEAR DRIPPER**  
**GOUTTEUR PIEU MIXTE**  
**GOTEJADOR LANÇA MIXTA**

Ref.	Cap (l/h)			€	Dimensiones A-B-C
2150	2x3 a 3x4,5	-	5.000	0,0399	113x1x2
2151	6,5x4,5	-	5.000	0,0638	113x4x11





**GOTERO REGULABLE GRAN CAUDAL**  
**GREAT FLOW ADJUSTABLE DRIPPER**  
**GOUTTEUR REGLABLE GRAND DEBIT**  
**GOTEJADOR REGULAVEL**

**GOTERO REGULABLE GRAN CAUDAL CON ESTACA**  
**GREAT FLOW ADJUSTABLE DRIPPER STAKE MOUNTED**  
**GOUTTEUR REGLABLE GRAND DEBIT AVEC PIEU**  
**GOTEJADOR REGULAVEL CON ESTACA**

Ref.	Cap (l/h)			€	Dimensiones A-B-C
2110	0 - 70	100	5.000	0,1001	
2114	0 - 70	100	5.000	0,1001	
2115	0 - 70	25	2.500	0,1254	

Ref.	Cap (l/h)			€	Dimensiones A-B-C
2192	0 - 40	-	1.000	0,2156	145x28x14
2111	0 - 70	-	1.000	0,2085	145x28x14
2116	0 - 70	-	1.000	0,2085	145x28x14
2193	0 - 100	-	1.000	0,3916	410x24x31



**GOTERO REGULABLE GRAN CAUDAL**  
**GREAT FLOW ADJUSTABLE DRIPPER**  
**GOUTTEUR REGLABLE GRAND DEBIT**  
**GOTEJADOR REGULAVEL**

**GOTERO REGULABLE GRAN CAUDAL**  
**GREAT FLOW ADJUSTABLE DRIPPER**  
**GOUTTEUR REGLABLE GRAND DEBIT**  
**GOTEJADOR REGULAVEL**

Ref.	Cap (l/h)			€	Dimensiones A-B-C
2190	0 - 40	100	5.000	0,1144	

Ref.	Cap (l/h)			€	Dimensiones A-B-C
2191	0 - 100	100	5.000	0,2420	



**GOTERO AUTOCOMPENSANTE DESMONTABLE LAGO**  
**REMOVABLE AUTO-COMPENSATE DRIPPER LAGO**  
**GOUTTEUR AUTO-COMPENSANT DEMONTABLE LAGO**  
**GOTEJADOR REMOVÍVEL AUTOCOMPENSÁVEL LAGO**

Ref.	Cap (l/h)			€	Dimensiones A-B-C
2122	2	200	4.000	0,2557	
2120	4	200	4.000	0,2557	
2125	4	25	2.000	0,3684	
2121	8	200	4.000	0,2557	
2126	8	25	2.000	0,3684	



**GOTERO AUTOCOMPENSANTE CLIPADO LAGO**  
**AUTO-COMPENSATE DRIPPER LAGO**  
**GOUTTEUR AUTO-COMPENSANT LAGO**  
**GOTEJADOR AUTOCOMPENSÁVEL LAGO**

Ref.	Cap (l/h)			€	Dimensiones A-B-C
2170	2	200	4.000	0,2304	
2171	4	200	4.000	0,2304	
2172	8	200	4.000	0,2304	



**GOTERO LABERINTO LAGO**  
**LABYRINT DRIPPER LAGO**  
**GOUTTEUR LABYRINTHE LAGO**  
**GOTEJADOR LABIRINTO LAGO**

Ref.	Cap (l/h)			€	Dimensiones A-B-C
2130	-	200	4.000	0,1797	
2135	-	25	2.000	0,2156	



**ACOPLE GOTERO Y MICROTUBO**  
**UNION FOR DRIPPER AND MICRO-HOSE**  
**RACCORD GOUTTEUR ET MICROTUBE**  
**ACOPLAMIENTO GOTERO E MICROTUBO**

Ref.	(Ø (mm)) - Salidas			€	Dimensiones A-B-C
2240	(4,5x6,5) - 1	1.000	10.000	0,0733	142x12x12
2241	(4,5x6,5) - 2	1.000	10.000	0,1240	142x12x12
2242	(4,5x6,5) - 4	1.000	10.000	0,1791	142x12x12
2243	(5x3) - 1	1.000	10.000	0,0733	142x12x12
2244	(5x3) - 2	1.000	10.000	0,1240	142x12x12
2245	(5x3) - 4	1.000	10.000	0,1791	142x12x12



## PIQUETA RECTA MICROTUBO MICRO-HOSE STRAIGHT STAKE PIEU DROIT MICROTUBE ESTACA RETA MICROTUBO

## PIQUETA CURVA MICROTUBO MICRO-HOSE BENT STAKE PIEU COURBÉ MICROTUBE ESTACA CURVA MICROTUBO

Ref.	Ø (mm)			€	Dimensiones A-B-C
2210	4,5x6,5	-	3.000	0,0572	142x12x12
2211	5x3	-	3.000	0,0572	142x12x12
2230	Laberinto 4,5x6,5	-	3.000	0,0629	151x12x12
2222	Paso lateral 4,5x6,5	-	3.000	0,0629	142x12x12
2224	Abrazadera 4,5x6,5	-	3.000	0,0629	142x12x12
2113	8-20 (l/h)	-	1.000	0,1840	

Ref.	Cap (l/h)			€	Dimensiones A-B-C
2220	4,5x6,5	-	3.000	0,0629	139x12x17
2221	5x3	-	3.000	0,0629	139x12x17
2231	Laberinto 4,5x6,5	-	3.000	0,0629	139x12x17
2223	Paso lateral 4,5x6,5	-	3.000	0,0629	139x12x17
2225	Abrazadera 4,5x6,5	-	3.000	0,0629	139x12x17





**GANCHO COLGAR MANGUERA**  
**HOOK FOR PIPING**  
**CROCHET POUR TUYAU**  
**GANCHO SUPORTE TUBO**

Ref.	Modelo (cm)			€	Dimensiones A-B-C
2410	3	-	5.000	0,0853	36x22x14
2411	9	-	2.000	0,1464	94x22x14
2412	16	-	2.000	0,1601	160x32x6



**PIQUETA SUJETA MICROTUBO**  
**MICRO-HOSE HOLDER STAKE**  
**PIEU POUR MICROTUBE**  
**ESTACA SUPORTE MICROTUBO**

Ref.	Ø (mm)			€	Dimensiones A-B-C
2420	1 a 6	-	5.000	0,0702	118x13x5
2421	Sujeción dentada	-	3.000	0,0944	118x13x5



**PINZA GUIA MANGUERA**  
**PIPING GUIDE PEG STAKE**  
**PIEU GUIDE TUYAU**  
**ESTACA SUPORTE TUBO**

Ref.	Ø (mm)			€	Dimensiones A-B-C
2430	12	-	5.000	0,0501	118x15x5
2431	16	-	2.500	0,0877	118x20x5



**ESTACA GUIA MANGUERA**  
**PIPING GUIDE STAKE**  
**PIEU GUIDE TUYAU**  
**ESTACA GUIA MANGUERA**

Ref.	Ø (mm)			€	Dimensiones A-B-C
2440	16 - 20	-	500	0,2759	190x25x19
2441	25 - 32	-	500	0,3261	200x35x19
2442	16 - 20 Garrote	-	500	0,3261	190x46x19
2443	● 16 - 20 Garrote Plano	-	1.000	0,1760	165x30x19
2444	● 16 - 20 Garrote Plano	-	1.000	0,1837	165x30x19



# ACCESORIOS DE PRESION *PRESSURE ACCESSOIRES*



# *ACCESSOIRES POUR PRESION ACCESORIOS DE PREÇÃO*

PRESSURE  
PRESIÓN

- 8 435277 940100
- 8 435277 940117
- 8 435277 940124
- 8 435277 940131
- 8 435277 940148
- 8 435277 940155
- 8 435277 940162
- 8 435277 940179
- 8 435277 940186
- 8 435277 940193
- 8 435277 940209
- 8 435277 940216
- 8 435277 940223
- 8 435277 940230
- 8 435277 940247
- 8 435277 940254
- 8 435277 940261
- 8 435277 940278
- 8 435277 940285
- 8 435277 940292
- 8 435277 940308
- 8 435277 940315
- 8 435277 940322



**COLLARIN TOMA 2 TORNILLOS**  
**2 BOLTS SADDLE CLAMP**  
**COLLIER DE PRISE 2 VISSES**  
**TOMADA DE CARGA 2 PARAFUSOS**

Ref.	Ø (mm-")			€	Ref. Doble	€
4010	25 - 1/2	1	100	1,7846	4110	2,7830
4011	25 - 3/4	1	100	1,7846	4111	2,7830
4012	32 - 1/2	1	100	2,1340	4112	3,3196
4013	32 - 3/4	1	100	2,1340	4113	3,3196
4014	32 - 1	1	100	2,1340	4114	3,3196
4015	40 - 1/2	1	100	2,4710	4115	3,8563
4016	40 - 3/4	1	100	2,4710	4116	3,8563
4017	40 - 1	1	100	2,4710	4117	3,8563
4018	50 - 1/2	1	50	2,9577	4118	4,6051
4019	50 - 3/4	1	50	2,9577	4119	4,6051
4020	50 - 1	1	50	2,9577	4120	4,6051
4021	50 - 1 1/4	1	50	2,9577	4121	4,6051

**Collarín doble se sirve bajo pedido**  
**Double saddle clamp delivered by order**



**COLLARIN TOMA 4 TORNILLOS**  
**4 BOLTS SADDLE CLAMP**  
**COLLIER DE PRISE 4 VISSES**  
**TOMADA DE CARGA 4 PARAFUSOS**



Ref.	Ø (mm-")			€	Ref. Doble	€
4022	63 - 1/2	1	50	4,0185	4122	6,2774
4023	63 - 3/4	1	50	4,0185	4123	6,2774
4024	63 - 1	1	50	4,0185	4124	6,2774
4025	63 - 1 1/4	1	50	4,0185	4125	6,2774
4026	63 - 1 1/2	1	50	4,0185	4126	6,2774
4027	75 - 1/2	1	50	5,8780	4127	9,1729
4028	75 - 3/4	1	50	5,8780	4128	9,1729
4029	75 - 1	1	50	5,8780	4129	9,1729
4030	75 - 1 1/4	1	50	5,8780	4130	9,1729
4031	75 - 1 1/2	1	50	5,8780	4131	9,1729
4032	75 - 2	1	50	5,8780	4132	9,1729

**Collarín doble se sirve bajo pedido**  
**Double saddle clamp delivered by order**







**COLLARIN TOMA 4 TORNILLOS**  
**4 BOLTS SADDLE CLAMP**  
**COLLIER DE PRISE 4 VISSES**  
**TOMADA DE CARGA 4 PARAFUSOS**

Ref.	Ø (mm-")			€	Ref. Doble	€
4033	90 - 1/2	1	25	6,8515	4133	10,6828
4034	90 - 3/4	1	25	6,8515	4134	10,6828
4035	90 - 1	1	25	6,8515	4135	10,6828
4036	90 - 1 1/4	1	25	6,8515	4136	10,6828
4037	90 - 1 1/2	1	25	6,8515	4137	10,6828
4038	90 - 2	1	25	6,8515	4138	10,6828
4039	110 - 1/2	1	20	7,4505	4139	11,6313
4040	110 - 3/4	1	20	7,4505	4140	11,6313
4041	110 - 1	1	20	7,4505	4141	11,6313
4042	110 - 1 1/4	1	20	7,4505	4142	11,6313
4043	110 - 1 1/2	1	20	7,4505	4143	11,6313
4044	110 - 2	1	20	7,4505	4144	11,6313
4045	125 - 1	-	20	10,3958	4145	16,2115
4046	125 - 1 1/4	-	20	10,3958	4146	16,2115
4047	125 - 1 1/2	-	20	10,3958	4147	16,2115
4048	125 - 2	-	20	10,3958	4148	16,2115

**Collarín doble se sirve bajo pedido**  
**Double saddle clamp delivered by order**

**COLLARIN TOMA 6 TORNILLOS**  
**6 BOLTS SADDLE CLAMP**  
**COLLIER DE PRISE 6 VISSES**  
**TOMADA DE CARGA 6 PARAFUSOS**

Ref.	Ø (mm-")			€	Ref. Doble	€
4049	140 - 1	-	15	19,2566	4149	30,0518
4050	140 - 1 1/4	-	15	19,2566	4150	30,0518
4051	140 - 1 1/2	-	15	19,2566	4151	30,0518
4052	140 - 2	-	15	19,2566	4152	30,0518
4053	160 - 1/2	-	15	19,2566	4153	30,0518
4054	160 - 1	-	15	19,2566	4154	30,0518
4055	160 - 1 1/4	-	15	19,2566	4155	30,0518
4056	160 - 1 1/2	-	15	19,2566	4156	30,0518
4057	160 - 2	-	15	19,2566	4157	30,0518
4058	200 - 2	-	6	41,0092	4158	63,9724
4059	200 - 2 1/2	-	6	41,0092	4159	63,9724
4060	200 - 3	-	6	41,0092	4160	63,9724

**Collarín doble se sirve bajo pedido**  
**Double saddle clamp delivered by order**

- 8 435277 940339
- 8 435277 940346
- 8 435277 940353
- 8 435277 940360
- 8 435277 940377
- 8 435277 940384
- 8 435277 940391
- 8 435277 940407
- 8 435277 940414
- 8 435277 940421
- 8 435277 940438
- 8 435277 940445
- 8 435277 940452
- 8 435277 940469
- 8 435277 940476
- 8 435277 940483
- 8 435277 940490
- 8 435277 940506
- 8 435277 940513
- 8 435277 940520
- 8 435277 940537
- 8 435277 940544
- 8 435277 940551
- 8 435277 940568
- 8 435277 940575
- 8 435277 940582
- 8 435277 940599

PRESSURE  
PRESION

- 8 435277 950116
- 8 435277 950123
- 8 435277 950130
- 8 435277 950147
- 8 435277 950154
- 8 435277 950161
- 8 435277 950215
- 8 435277 950222
- 8 435277 950239
- 8 435277 950246
- 8 435277 950253
- 8 435277 950260
- 8 435277 950314
- 8 435277 950321
- 8 435277 950338
- 8 435277 950345
- 8 435277 950352
- 8 435277 950369
- 8 435277 951113
- 8 435277 951120
- 8 435277 951137
- 8 435277 951144
- 8 435277 951151
- 8 435277 951168
- 8 435277 951212
- 8 435277 951229
- 8 435277 951236



**MANGUITO ENCOLAR PVC  
PVC UNION TO GLUE  
RACCORD PVC A COLLER  
UNIAO PVC COLAR**

Ref.	Ø (mm)		€
5011	20	- 200	0,4919
5012	25	- 200	0,5948
5013	32	- 100	0,7321
5014	40	- 100	1,0753
5015	50	- 50	1,3156
5016	63	- 50	2,1049
5017	75	- 35	4,5093
5018	90	- 25	4,8039
5019	110	- 25	4,8039



**MANGUITO MIXTO PVC  
PVC UNION MIXED  
RACCORD PVC MIXTE  
UNIAO PVC MIXTA**

Ref.	Ø (mm - ")		€
5021	20 - 1/2	- 200	0,8122
5022	25 - 3/4	- 200	0,9152
5023	32 - 1	- 100	1,0982
5024	40 - 1 1/4	- 100	1,6016
5025	50 - 1 1/2	- 50	2,3337
5026	63 - 2	- 50	2,9972
5027	75 - 2 1/2	- 35	7,5684
5028	90 - 3	- 25	10,6048
5029	110 - 4	- 25	16,6551



**TAPON ENCOLAR PVC  
PVC PLUG TO GLUE  
BOUCHON PVC A COLLER  
TACO PVC COLAR**

Ref.	Ø (mm)		€
5031	20	- 200	0,4576
5032	25	- 200	0,4804
5033	32	- 100	0,7321
5034	40	- 100	1,0524
5035	50	- 50	1,4414
5036	63	- 50	1,9791
5037	75	- 50	4,1241
5038	90	- 35	5,0985
5039	110	- 25	11,4659



**CODO PVC HEMBRA A ENCOLAR  
PVC ELBOW TO GLUE  
COUDE PVC A COLLER  
JOELHO PVC F/F COLAR**

Ref.	Ø (mm)		€	Dimensiones A-B-C
5111	20	- 100	0,4804	
5112	25	- 100	0,6749	
5113	32	- 100	0,9724	
5114	40	- 80	1,4643	
5115	50	- 40	1,8304	
5116	63	- 40	3,0201	
5117	75	- 25	5,2571	
5118	90	- 25	8,7014	
5119	110	- 15	15,1368	



**CODO PVC HEMBRA A ENCOLAR - R/HEMBRA  
FEMALE THREADED PVC ELBOW TO GLUE  
COUDE PVC TARAUDE ET A COLLER  
JOELHO PVC F. ROSCA - F.COLAR**

Ref.	Ø (mm)		€	Dimensiones A-B-C
5121	20 - 1/2	- 100	1,0753	
5122	25 - 3/4	- 100	1,1440	
5123	32 - 1	- 100	1,8304	
5124	40 - 1 1/4	- 80	2,2880	
5125	50 - 1 1/2	- 40	2,7456	
5126	63 - 2	- 40	4,9192	
5127	75 - 2 1/2	- 25	15,1368	
5128	90 - 3	- 25	23,7250	
5129	110 - 4	- 15	36,3466	

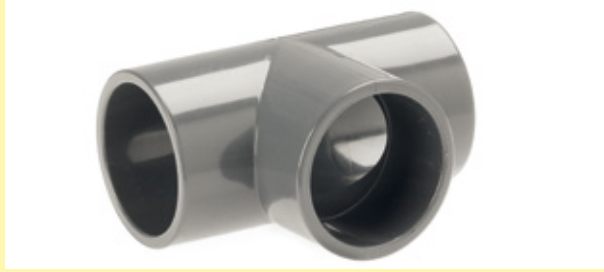

**TE PVC HEMBRA A ENCOLAR  
PVC TEE TO GLUE  
TE PVC A COLLER  
TE PVC F/F COLAR**

Ref.	Ø (mm)		€	Dimensiones A-B-C
5131	20	- 100	0,6292	
5132	25	- 100	0,8684	
5133	32	- 100	1,2116	
5134	40	- 80	1,9219	
5135	50	- 40	2,6312	
5136	63	- 40	3,8324	
5137	75	- 25	7,0019	
5138	90	- 25	11,4206	
5139	110	- 15	19,7595	



**TE PVC HEMBRA A ENCOLAR - R/HEMBRA  
FEMALE THREADED PVC TEE TO GLUE  
TE PVC TARAUDE ET A COLLER  
TE PVC F. ROSCA - F.COLAR**

Ref.	Ø (mm)		€	Dimensiones A-B-C
5141	20 - 1/2	- 100	1,6473	
5142	25 - 3/4	- 100	1,8075	
5143	32 - 1	- 100	2,3795	
5144	40 - 1 1/4	- 80	3,6150	
5145	50 - 1 1/2	- 40	5,2624	
5146	63 - 2	- 40	6,7038	
5147	75 - 2 1/2	- 25	17,6748	
5148	90 - 3	- 25	26,2629	
5149	110 - 4	- 15	42,918	



**VALVULA PVC ENCOLAR ASIENTO PTFE**  
**PVC BALL VALVE TO GLUE WITH PTFE JOINT**  
**VANNE PVC A BILLE A COLLER JOINT PTFE**  
**VALVULA COLAR PTFE**

**VALVULA PVC HEMBRA ASIENTO PTFE**  
**FEMALE THREADED PVC BALL VALVE WITH PTFE JOINT**  
**VANNE PVC A BILLE FEMELLE AVEC JOINT PTFE**  
**VALVULA ROSCAR HEMBRA PTFE**

Ref.	Ø (mm)			€	Dimensiones A-B-C
4211	20	-	40	10,3303	76x51x71
4212	25	-	40	12,7899	98x60x79
4213	32	-	30	16,9083	117x74x99
4214	40	-	20	21,5415	126x88x110
4215	50	-	15	28,6343	142x100x131
4216	63	-	10	36,3219	148x116x147
4218	90	-	2	277,9392	
4219	110	-	2	418,9856	
4255	50 (NPT)	-	15	31,4977	142x100x131
4256	63 (NPT)	-	10	39,9542	148x116x147
4258	90 (NPT)	-	2	305,73312	
4259	110 (NPT)	-	2	460,8769	

Ref.	Ø (")			€	Dimensiones A-B-C
4221	1/2	-	40	10,6792	76x51x71
4222	3/4	-	40	12,9500	98x60x79
4223	1	-	30	17,5718	117x74x99
4224	1 1/4	-	20	22,0563	126x88x110
4225	1 1/2	-	15	29,4008	142x100x131
4226	2	-	10	37,0427	148x116x147
4228	3	-	2	293,1808	
4229	4	-	2	444,1712	
4265	1 1/2 (NPT)	-	15	32,3408	142x100x131
4266	2 (NPT)	-	10	40,7469	148x116x147
4268	3 (NPT)	-	2	322,4988	
4269	4 (NPT)	-	2	488,588	

\*Los articulos NPT se fabricarán bajo pedido



**VALVULA PVC TOMA FITTING ASIENTO PTFE**  
**FITTING PVC BALL VALVE WITH PTFE JOINT**  
**VANNE PVC A BILLE RACCORD FITTING AVEC JOINT PTFE**  
**VALVULA FITTING PVC PTFE**

**VALVULA PVC MACHO ASIENTO PTFE**  
**MALE THREADED PVC BALL VALVE WITH PTFE JOINT**  
**VANNE PVC A BILLE MALE AVEC JOINT PTFE**  
**VALVULA ROSCAR MACHO PTFE**

Ref.	Ø (mm)			€	Dimensiones A-B-C
4231	20	-	40	12,7556	161x51x71
4232	25	-	40	15,4211	190x60x79
4233	32	-	30	21,0839	235x74x99
4234	40	-	20	26,3348	265x88x110
4235	50	-	15	35,1322	310x100x131
4236	63	-	10	44,3757	337x116x147

Ref.	Ø (")			€	Dimensiones A-B-C
4241	1/2	-	40	10,6392	100x51x71
4242	3/4	-	40	12,9500	125x60x79
4243	1	-	30	17,5718	150x74x99
4244	1 1/4	-	20	22,0563	167x88x110
4245	1 1/2	-	15	29,4008	196x100x131
4246	2	-	10	37,0427	221x116x147



PRESSURE  
PRESIÓN





**Extraemos accesorios 1,2,3 y 4 del producto.**  
*We extract 1,2,3 and 4 accessories from the product.*

**Colocamos los accesorios extraídos en el tubo.**  
*We put the extracted accessories in the tube.*



**Introducimos el tubo dentro del cuerpo del producto**  
*We introduce the tube into the product body*



**Juntamos los accesorios 1,2,3 y 4 con el cuerpo del producto.**  
*We join the 1,2,3 and 4 accessories with the product body.*



**Enroscamos el accesorio 1 con el cuerpo del producto y apretamos con la llave.**  
*We screw the accessory 1 with the product body and tighten with the key.*



**\*Llaves de apretar fitting disponibles (Referencias 0550, 0551 y 0552).**

**\*Wrench for fastening fitting available (References 0550, 0551 and 0552).**



**ENLACE FITTING ROSCA HEMBRA**  
**FEMALE THREADED FITTING UNION P.E.**  
**RACCORD PRESSION TARAUDE P.E.**  
**FITTING R/F**

**ENLACE FITTING ROSCA MACHO**  
**MALE THREADED FITTING UNION P.E.**  
**RACCORD PRESSION FILETÉ P.E.**  
**FITTING R/M**

Ref.	Ø (mm - ")			€	Dimensiones A-B-C
4410	16 - 1/2	1	100	1,3384	62x41x41
4411	20 - 1/2	1	100	1,3384	62x41x41
4412	25 - 3/4	1	100	1,6473	76x48x48
4413	32 - 1	1	100	2,2536	88x57x57
4414	40 - 1 1/4	-	50	3,2718	102x68x68
4415	50 - 1 1/2	-	50	4,9420	119x83x83
4416	63 - 2	-	30	6,8754	140x103x103
4417	75 - 2 1/2	-	8	13,5335	166x119x119
4418	90 - 3	-	6	23,1888	175x145x145

Ref.	Ø (mm - ")			€	Dimensiones A-B-C
4420	16 - 1/2	1	100	1,1783	69x41x41
4421	20 - 1/2	1	100	1,1783	69x41x41
4422	25 - 3/4	1	100	1,5444	82x48x48
4423	32 - 1	1	100	2,3337	101x57x57
4424	40 - 1 1/4	-	50	3,1574	113x68x68
4425	50 - 1 1/2	-	50	4,1412	113x68x83
4426	63 - 2	-	26	6,3720	156x103x103
4427	75 - 2 1/2	-	8	11,5887	177x118x118
4428	90 - 3	-	6	18,3612	193x144x144



PRESSURE  
PRESIÓN

- 8 435277 944306
- 8 435277 944313
- 8 435277 944320
- 8 435277 944337
- 8 435277 944344
- 8 435277 944351
- 8 435277 944368
- 8 435277 944375
- 8 435277 944382
- 8 435277 944429
- 8 435277 944436
- 8 435277 944443
- 8 435277 944450
- 8 435277 944467
- 8 435277 944474
- 8 435277 944481
- 8 435277 944528
- 8 435277 944535
- 8 435277 944603
- 8 435277 944610
- 8 435277 944627
- 8 435277 944634
- 8 435277 944641
- 8 435277 944658
- 8 435277 944665
- 8 435277 944672
- 8 435277 944689



**MANGUITO FITTING P.E.**  
**FITTING UNION P.E.**  
**RACCORD PRESSION P.E.**  
**FITTING UNIAO P.E.**

Ref.	Ø (mm)			€	Dimensiones A-B-C
4430	16	1	100	1,8761	104x41x41
4431	20	1	100	1,8761	104x41x41
4432	25	1	100	2,2994	119x48x48
4433	32	1	100	3,2832	139x57x57
4434	40	-	50	5,2052	162x67x67
4435	50	-	30	7,3559	185x83x83
4436	63	-	24	11,0510	212x103x103
4437	75	-	10	18,3612	272x118x118
4438	90	-	6	30,7278	292x145x145



**TAPON FITTING P.E.**  
**FITTING PLUG P.E.**  
**BOUCHON PRESSION P.E.**  
**FITTING TACO P.E.**

Ref.	Ø (mm)			€	Dimensiones A-B-C
4460	16	1	100	1,3270	59x41x41
4461	20	1	100	1,3270	59x41x41
4462	25	1	100	1,6816	72x48x48
4463	32	1	100	2,3223	84x57x57
4464	40	-	50	3,1460	98x68x68
4465	50	-	50	5,5484	118x83x83
4466	63	-	30	8,3969	127x104x104
4467	75	-	8	19,3600	155x118x118
4468	90	-	6	29,5838	166x145x145



**MANGUITO FITTING REDUCIDO P.E.**  
**REDUCING FITTING UNION P.E.**  
**RACCORD PRESSION REDUIT P.E.**  
**FITTING UNIAO REDUCAO P.E.**

Ref.	Ø (mm)			€	Dimensiones A-B-C
4442	25 - 20	1	50	2,2994	129x57x57
4443	32 - 25	1	60	3,2832	129x57x57
4444	40 - 32	-	30	5,2052	148x67x67
4445	50 - 40	-	10	7,3559	175x83x83
4446	63 - 50	-	20	11,0052	205x103x103
4447	75 - 63	-	10	21,0429	236x121x121
4448	90 - 75	-	6	31,8489	269x144x144



**MANGUITO FITTING PASAMUROS P.E.**  
**FITTING TANK CONNECTOR UNION P.E.**  
**RACCORD PRESSION TRAVERSE-PAROI P.E.**  
**FITTING UNIAO PASSA MUROS P.E.**

Ref.	Ø (mm - ")			€	Dimensiones A-B-C
4452	25 - 3/4	1	50	4,0268	128x52x52
4453	32 - 1	1	50	6,1089	152x60x60







**TE FITTING IGUAL P.E.**  
**TEE FITTING P.E.**  
**TE PRESSION P.E.**  
**FITTING TE P.E.**

**TE FITTING MACHO P.E.**  
**MALE THREADED FITTING TEE P.E.**  
**TE PRESSION FILETÉ P.E.**  
**FITTING TE MACHO P.E.**

Ref.	Ø (mm)			€	Dimensiones A-B-C
4510	16	1	100	2,9286	125x82x82
4511	20	1	100	2,9286	125x82x82
4512	25	1	100	3,6036	1455x97x48
4513	32	1	70	5,1973	175x116x57
4514	40	-	30	7,9050	202x133x68
4515	50	-	16	11,8289	240x160x83
4516	63	-	10	16,8396	283x193x103
4517	75	-	5	38,3899	
4518	90	-	4	52,6240	

Ref.	Ø (mm - ")			€	Dimensiones A-B-C
4530	16 - 1/2	1	100	2,4138	124x56x41
4531	20 - 1/2	1	100	2,4138	124x56x41
4532	25 - 3/4	1	100	3,3748	145x65x48
4533	32 - 1	1	80	4,2338	174x176x57
4534	40 - 1 1/4	-	40	5,5255	202x89x67
4535	50 - 1 1/2	-	16	7,7220	140x113x83
4536	63 - 2	-	10	12,1492	283x138x103
4537	75 - 2 1/2	-	6	29,7439	
4538	90 - 3	-	3	40,0400	



**TE FITTING REDUCIDO P.E.**  
**REDUCING FITTING TE P.E.**  
**TE PRESSION REDUIT P.E.**  
**FITTING TE REDUCAO P.E.**

**TE FITTING HEMBRA P.E.**  
**FEMALE THREADED FITTING TEE P.E.**  
**TE PRESSION TARAUE P.E.**  
**FITTING TE HEMBRA P.E.**

Ref.	Ø (mm)			€	Dimensiones A-B-C
4542	25 - 20	1	100	3,4548	146x89x48
4543	32 - 25	1	70	4,4959	173x106x57
4544	40 - 32	-	50	7,0356	203x125x68
4545	50 - 40	-	16	9,8384	239x146x83
4546	63 - 50	-	10	14,8376	284x184x104

Ref.	Ø (mm - ")			€	Dimensiones A-B-C
4521	20 - 1/2	1	100	2,5740	124x51x41
4522	25 - 3/4	1	100	3,6951	145x57x48
4523	32 - 1	1	80	5,2509	175x69x57
4524	40 - 1 1/4	-	40	6,5780	203x79x67
4525	50 - 1 1/2	-	16	9,5066	240x98x83
4526	63 - 2	-	10	15,0436	183x121x103

- 8 435277 945105
- 8 435277 945112
- 8 435277 945129
- 8 435277 945136
- 8 435277 945143
- 8 435277 945150
- 8 435277 945167
- 8 435277 945174
- 8 435277 945181
- 8 435277 945211
- 8 435277 945228
- 8 435277 945235
- 8 435277 945242
- 8 435277 945259
- 8 435277 945266
- 8 435277 945303
- 8 435277 945310
- 8 435277 945327
- 8 435277 945334
- 8 435277 945341
- 8 435277 945358
- 8 435277 945365
- 8 435277 945372
- 8 435277 945389
- 8 435277 945426
- 8 435277 945433
- 8 435277 945440

PRESSURE  
PRESIÓN

- 8 435277 946102
- 8 435277 946119
- 8 435277 946126
- 8 435277 946133
- 8 435277 946140
- 8 435277 946157
- 8 435277 946164
- 8 435277 946171
- 8 435277 946188
- 8 435277 946201
- 8 435277 946218
- 8 435277 946225
- 8 435277 946232
- 8 435277 946249
- 8 435277 946256
- 8 435277 946263
- 8 435277 946270
- 8 435277 946287
- 8 435277 946317
- 8 435277 946324
- 8 435277 946331
- 8 435277 946348
- 8 435277 946355
- 8 435277 946362



**CODO FITTING IGUAL P.E.**  
**FITTING ELBOW P.E.**  
**COUDE PRESSION P.E.**  
**FITTING JOELHO P.E.**

Ref.	Ø (mm)			€	Dimensiones A-B-C
4610	16	1	100	1,9905	88x88x41
4611	20	1	100	1,9905	88x88x41
4612	25	1	100	2,3566	104x104x48
4613	32	1	100	3,3976	125x125x57
4614	40	-	40	5,4454	142x142x67
4615	50	-	20	7,7334	172x172x83
4616	63	-	12	11,9433	205x205x104
4617	75	-	6	28,5009	
4618	90	-	6	41,1839	



**CODO FITTING MACHO P.E.**  
**MALE THREADED FITTING ELBOW P.E.**  
**COUDE PRESSION FILETÉ P.E.**  
**FITTING JOELHO MACHO P.E.**

Ref.	Ø (mm - ")			€	Dimensiones A-B-C
4620	16 - 1/2	1	100	1,8674	82x67x41
4621	20 - 1/2	1	100	1,8647	82x67x41
4622	25 - 3/4	1	100	2,2994	97x76x48
4623	32 - 1	1	100	2,7227	116x87x57
4624	40 - 1 1/4	-	30	3,5235	135x104x68
4625	50 - 1 1/2	-	30	4,6904	160x125x93
4626	63 - 2	-	20	6,5208	192x157x103
4627	75 - 2 1/2	-	6	24,20	
4628	90 - 3	-	6	33,4399	



**CODO FITTING HEMBRA P.E.**  
**FEMALE THREADED FITTING ELBOW P.E.**  
**COUDE PRESSION TARAUDE P.E.**  
**FITTING JOELHO HEMBRA P.E.**

Ref.	Ø (mm)			€	Dimensiones A-B-C
4631	20 - 1/2	1	100	2,6998	84x54x41
4632	25 - 3/4	1	100	3,1803	97x61x48
4633	32 - 1	1	100	3,8781	117x80x57
4634	40 - 1 1/4	-	30	4,7361	137x98x68
4635	50 - 1 1/2	-	30	6,1547	161x101x82
4636	63 - 2	-	20	7,4016	195x124x103



**CARACTERISTICAS FITTING**

- Accesorios para tubería de presión, fabricados en P.D.F.V. ingles (Polipropileno con Fibra de Vidrio) en las proporciones adecuadas en cuerpos y tuercas.
- Prisioneros de Poliamida.
- Arandela en A.B.S.
- Juntas tóricas.

Este producto, por su especial diseño tanto exterior como interior, está preparado pa tuberías de 4-6-10-16 ATM P.E.B.D. (Polietileno Baja Densidad). Además tener en cuenta evidentemente los diámetros de tuberías que están calibrados en su medida , toda uniforme.

Las distintas referencias de roscas machos y roscas hembras están preparadas pa a ser roscadas en accesorios que presten las medidas adecuadas en sus roscas en producto P.P.

Se recomienda que la manguera tenga un corte limpio y homogéneo en su círculo, n presentar la manguera chafada, por lo que ganaremos rapidez en su montaje y obtendremos un resultado positivo en todo su conjunto de ensamblaje.

**FITTING CHARACTERISTICS**

- Accessories for pressure pipes, made of P.D.F.V. (polyethylene with fibreglass) with bodies and threaded connectors made in adequate proportions.
- Polyamide fasteners.
- A.B.S. washers.
- O-Rings

This product is ready for 4-6-10-16 ATM P.E.B.D. (low density polyethylene) thanks t both its outer and interior design. Please, bear in mind that the pipe diameters are eve and proporcionally well calibrated.

Different referencies of male and female threaded connectors are ready to be screw on/in accessories that present suitable measures on their threaded connectors, and o P.P. product.

It is recommended to have the hose with a clean uniform cut on the diameter. Do not present a squashed hose, so we can speed up the installation process and obtain positive results in the assembly.



PRESSURE  
PRESIÓN

**CODO FITTING 3 SALIDAS (2 FITTING - 1 R/HEMBRA) P.E.**  
**3 OULETS FITTING ELBOW (2 FITTING - 1 FEMALE) P.E.**  
**COUDE PRESSION 3 SORTIES (2 PRESSION - 1 TARAUDÉ) P.E.**  
**JOELHO FITTING 3 SAIDAS (2 FITTING - 1 R/H)**

**CODO FITTING 3 SALIDAS (1 FITTING - 1 R/HEMBRA - 1 R/MACHO) P.E.**  
**3 OULETS FITTING ELBOW (1 FITTING - 1 FEMALE - 1 MALE) P.E.**  
**COUDE PRESSION 3 SORTIES (1 PRESSION - 1 FILETÉ - 1 TARAUDÉ) P.E.**  
**JOELHO FITTING 3 SAIDAS (1 FITTING - 1 R/H - 1 R/M)**

Ref.	Ø (mm - ")			€	Dimensiones A-B-C
4642	25 - 25 - (1/2)	1	50	5,1365	102x102x53
4643	32 - 32 - (3/4)	1	50	6,2691	122x122x59

Ref.	Ø (mm - ")			€	Dimensiones A-B-C
4652	25 - 3/4 - (1/2)	1	50	4,5416	93x73x53
4653	32 - 1 - (3/4)	1	50	5,7428	115x88x59



**CODO FITTING 3 SALIDAS (1 FITTING - 1 R/HEMBRA - 1 R/MACHO) P.E.**  
**3 OULETS FITTING ELBOW (1 FITTING - 1 FEMALE - 1 MALE) P.E.**  
**COUDE PRESSION 3 SORTIES (1 PRESSION - 1 FILETÉ - 1 TARAUDÉ) P.E.**  
**JOELHO FITTING 3 SAIDAS (1 FITTING - 1 R/H - 1 R/M)**

**CODO FITTING PARA GRIFO P.E.**  
**TAP COUPLING FITTING ELBOW P.E.**  
**COUDE PRESSION FILETÉ POUR ROBINET P.E.**  
**FITTING JOELHO TOQUE P.E.**

Ref.	Ø (mm - ")			€	Dimensiones A-B-C
4662	25 - 3/4 - (1/2)	1	50	5,1365	98x63x53
4663	32 - 1 - (3/4)	1	50	6,3263	118x80x60

Ref.	Ø (mm - ")			€	Dimensiones A-B-C
4671	20 - 1/2	1	100	3,6379	53x49x89
4672	25 - 3/4	1	100	3,9753	64x59x102



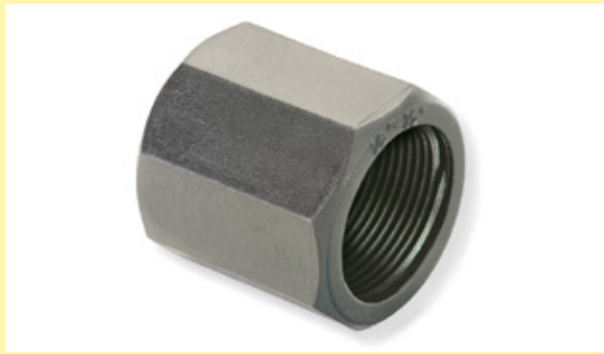

**MANGUITO ROSCA HEMBRA**  
**FEMALE THREADED UNION**  
**MANCHON FEMELLE**  
**UNIAO FEMEA**

Ref.	Ø (")			€	Dimensiones A-B-C
1520	3/8	-	500	0,4728	
4711	1/2	-	200	0,4728	30x30x30
4712	3/4	-	200	0,5438	37x35x35
4719	3/4 (Largo)	-	200	0,6380	
4713	1	-	100	1,4659	41x44x44
4714	1 1/4	-	100	1,6550	40x52x52
4715	1 1/2	-	100	2,3410	55x62x62
4716	2	-	100	3,7361	61x76x76
4717	2 1/2	-	20	11,2314	98x95x95
4718	3	-	10	12,4139	113x111x111

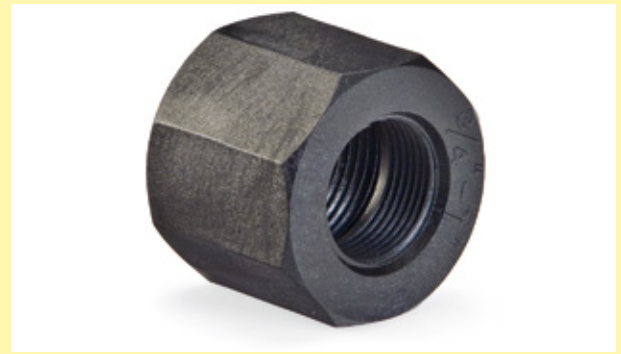

**MANGUITO ROSCA HEMBRA REDUCIDO**  
**REDUCING FEMALE THREADED UNION**  
**MACHON FEMELLE REDUIT**  
**UNIAO FEMEA REDUCAO**

Ref.	Ø (" - ")			€	Dimensiones A-B-C
4722	3/4 - 1/2	-	200	0,5438	35x35x35
4723	1 - 3/4	-	100	1,4659	41x44x44
4724	1 1/4 - 1	-	100	1,6550	42x52x52
4725	1 1/2 - 1 1/4	-	100	2,3410	55x61x61
4726	2 - 1 1/2	-	100	3,7361	61x76x76
4727	2 1/2 - 2	-	20	11,2314	99x93x93
4728	3 - 2 1/2	-	10	12,4139	113x111x111



**RACOR MARSELLA**  
**MARSELLA UNION**  
**RACCORD MARSELLA**  
**UNIAO PP F/M**

Ref.	Ø (" - ")			€	Dimensiones A-B-C
4730	1/2 - 3/4	-	200	1,0229	37x35x35
4731	1/2 - 1	-	200	1,2738	40x45x45
4732	1/2 - 1 1/4	-	100	1,7177	51x52x52
4733	3/4 - 1	-	200	1,4012	40x45x45
4734	3/4 - 1 1/4	-	100	1,7177	51x52x52
4735	3/4 - 1 1/2	-	200	2,6442	52x62x62
4736	1 - 1 1/4	-	200	1,7177	
4737	1 - 1 1/2	-	200	2,6442	
4738	1 - 2	-	100	3,9662	





**TUERCA REDUCCION**  
**REDUCING THREADED UNION MALE - FEMALE**  
**RACCORD DE REDUCTION MALE - FEMELLE**  
**UNIAO PP M/F**

Ref.	Ø (" - ")			€	Dimensiones A-B-C
4742	3/4 - 1/2	-	200	0,4257	31x30x30
4743	1 - 3/4	-	200	0,4964	45x36x36
4756	1 - 3/4 (Sinfin)	-	200	0,5957	
4744	1 1/4 - 1	-	100	0,8133	44x50x50
4745	1 1/2 - 1 1/4	-	100	1,6550	40x53x53
4746	2 - 1 1/2	-	100	2,1281	39x63x63
4747	2 1/2 - 2	-	50	2,8374	44x79x79
4748	3 - 2 1/2	-	25	5,2020	51x93x93
4750	1 - 1/2	-	200	0,5957	45x36x36
4751	1 1/4 - 3/4	-	200	0,5957	47x45x45
4752	1 1/2 - 3/4	-	100	1,9806	39x43x43
4753	1 1/2 - 1	-	100	1,9860	39x53x53
4754	2 - 1	-	100	2,5538	39x62x62
4755	2 - 1 1/4	-	100	2,5538	39x63x63



**MACHON ROSCADO**  
**MALE THREADED UNION**  
**MACHON FILETÉ**  
**CASQUILHO DUPLO**

**MACHON ROSCADO REDUCIDO**  
**MALE REDUCING THREADED UNION**  
**MANCHON FILETÉ REDUIT**  
**CASQUILHO PP RED M/M**

Ref.	Ø (")			€	Dimensiones A-B-C
4819	1/4	-	250	0,2245	27x17x17
4810	3/8	-	250	0,2245	34x19x19
4811	1/2	-	250	0,2245	33x29x29
4812	3/4	-	200	0,2835	37x35x35
4813	1	-	150	0,4257	40x39x39
4814	1 1/4	-	150	0,5910	51x45x45
4815	1 1/2	-	100	0,9458	64x53x53
4816	2	-	100	1,5369	64x62x62
4817	2 1/2	-	30	1,8914	73x79x79
4818	3	-	30	2,8374	85x93x93

Ref.	Ø (")			€	Dimensiones A-B-C
4822	3/4 - 1/2	-	200	0,2835	38x35x35
4823	1 - 3/4	-	150	0,4257	40x39x39
4824	1 1/4 - 1	-	150	0,5910	47x45x45
4825	1 1/2 - 1 1/4	-	100	0,9458	59x53x53
4826	2 - 1 1/2	-	100	1,5369	65x63x63
4827	2 1/2 - 2	-	30	1,8914	69x79x79
4828	3 - 2 1/2	-	30	2,8374	81x93x93



**CODO MACHO**  
**MALE THREADED ELBOW**  
**COUDE FILETÉ**  
**JOELHO MAHCO**

**TE MACHO**  
**MALE THREADED TE**  
**TE FILETE**  
**TE MACHO**

Ref.	Ø (")			€	Dimensiones A-B-C
4831	1/2	-	100	1,0078	
4832	3/4	-	100	1,1365	
4833	1	-	100	1,5654	
4834	1 1/4	-	50	2,0587	
4835	1 1/2	-	50	3,3800	
4836	2	-	50	6,4550	

Ref.	Ø (")			€	Dimensiones A-B-C
4841	1/2	-	100	1,3725	
4842	3/4	-	100	1,5654	
4843	1	-	100	2,0587	
4844	1 1/4	-	50	2,8308	
4845	1 1/2	-	50	4,8893	
4846	2	-	50	9,0282	

- 8 435277 948106
- 8 435277 948113
- 8 435277 948120
- 8 435277 948137
- 8 435277 948144
- 8 435277 948151
- 8 435277 948168
- 8 435277 948175
- 8 435277 948182
- 8 435277 948199
- 8 435277 948229
- 8 435277 948236
- 8 435277 948243
- 8 435277 948250
- 8 435277 948267
- 8 435277 948274
- 8 435277 948281
- 8 435277 948311
- 8 435277 948328
- 8 435277 948335
- 8 435277 948342
- 8 435277 948359
- 8 435277 948366
- 8 435277 948410
- 8 435277 948427
- 8 435277 948434
- 8 435277 948441

PRESSURE  
PRESIÓN

- 8 435277 949103
- 8 435277 949110
- 8 435277 949127
- 8 435277 949134
- 8 435277 949141
- 8 435277 949158
- 8 435277 949165
- 8 435277 949172
- 8 435277 949189
- 8 435277 949196
- 8 435277 949219
- 8 435277 949226
- 8 435277 949233
- 8 435277 949240
- 8 435277 949257
- 8 435277 949264
- 8 435277 949318
- 8 435277 949325
- 8 435277 949332
- 8 435277 949417
- 8 435277 949424
- 8 435277 949431



**TAPON MACHO**  
**MALE PLUG**  
**BOUCHON MALE**  
**TACO MACHO**

Ref.	Ø (")		€	Dimensiones A-B-C
4919	1/4	- 250	0,2245	17x17x17
4910	3/8	- 250	0,2245	21x19x19
4911	1/2	- 250	0,2245	22x29x29
4912	3/4	- 200	0,2835	27x35x35
4913	1	- 150	0,5910	29x39x39
4914	1 1/4	- 150	0,7096	36x45x45
4915	1 1/2	- 100	0,9458	42x52x52
4916	2	- 100	1,5369	42x62x62
4917	2 1/2	- 30	1,8914	48x78x78
4918	3	- 30	2,8374	57x92x92



**TAPON HEMBRA**  
**FEMALE PLUG**  
**BOUCHON FEMELLE**  
**TACO FEMEA**

Ref.	Ø ( " - ")		€	Dimensiones A-B-C
4921	1/2	- 250	0,5791	20x39x39
4922	3/4	- 200	0,6756	21x42x42
4923	1	- 150	1,0229	25x45x45
4924	1 1/4	- 150	1,4090	
4925	1 1/2	- 100	1,8528	
4926	2	- 100	3,4742	
4928	3	- 50	6,5000	



**TAPON MACHO HEXAGONAL LARGO**  
**MALE LONG PLUS WITH HEXAGON HEAD**  
**LONG BOUCHON MALE TETE HEXAGONAL**  
**TACO MACHO HEXAGONAL COMPIMIDO PRETO**

Ref.	Ø ( " - ")		€	Dimensiones A-B-C
4931	1/2	- 500	0,4043	69x20x12
4932	1/2	- 500	0,4698	69x20x12
4933	1/2	- 500	0,4698	69x20x12

**TAPÓN MACHO HEXAGONAL LARGO**  
Largo idóneo para salvar el alcatado en las PRUEBAS de obras.  
Incorpora una junta para asegurar su estanqueidad

**CARACTERÍSTICAS ROSCADAS**  
Accesorios auxiliares fabricados con materia prima de alta calidad, elaborados a las temperaturas adecuadas para poder ofrecer un margen de tolerancia entre los mismos.  
A merced de su diseño presenta un acabado limpio, teniendo como elemento auxiliar de la propia pieza una de las partes hexagonales para poder roscar con más seguridad y firmeza.

Las distintas referencias de roscas machos y roscas hembras están preparadas para ser roscadas en accesorios que presten las medidas adecuadas en sus roscas, en producto P.P.



**TAPON MACHO HEXAGONAL**  
**MALE PLUG WITH HEXAGON HEAD**  
**BOUCHON MALE TETE HEXAGONALE**  
**TACO MACHO HEXAGONAL PRETO**

Ref.	Ø ( " - ")		€	Dimensiones A-B-C
4941	1/2	- 500	0,1515	24x24x19
4942	1/2	- 500	0,2120	24x24x19
4943	1/2	- 500	0,2120	24x24x19

**LARGE HEXAGONAL MALE PLUG**  
Ideal length to overcome the tiling  
It includes a joint to secure its watertightness.

**THREADED CONNECTORS CHARACTERISTICS**  
Assistant accessories made of the highest quality raw material and manufactured at the right temperatures to offer a tolerant margin between them.

At the mercy of their design, they presents a clean finish, having as an assistant component (part of their body) an hexagonal part, so that they can be screwed in much safer and with firmness.

The difference references of male and female threaded connectors are ready to be screwed on/in accessories that present suitable measures on their threaded connectors (and on PP product)



# ACCESORIOS DE EVACUACIÓN

## EVACUATION ACCESSOIRES

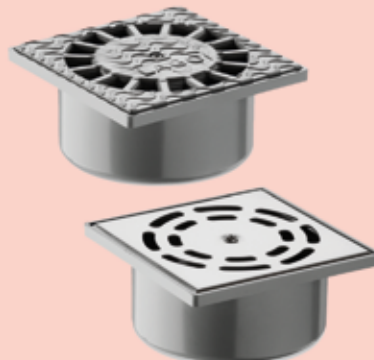

ACCESSOIRES POUR L'EVACUATION

ACCESORIOS DE EVACUAÇÃO

- 8 435277 960108
- 8 435277 960115
- 8 435277 960207
- 8 435277 960214
- 8 435277 960221
- 8 435277 960238
- 8 435277 960245
- 8 435277 960252
- 8 435277 960306
- 8 435277 960313
- 8 435277 960320
- 8 435277 960337
- 8 435277 960405
- 8 435277 960412
- 8 435277 960504
- 8 435277 960511
- 8 435277 960528



**L-98**

**SUMIDERO SIFONICO VERTICAL**  
**VERTICAL DRAIN FLOOR**  
**AVALOIR SORTIE VERTICALE COLAR**  
**SUMIDOURO SIFONICO VERTICAL COLAR**

Ref.	Sup (mm) - Ø (mm)			€	Dimensiones A-B-C
6024	104x104 - 50-40	-	50	4,4935	104x104x45
6025	104x104 Inox - 50-40	-	50	6,5400	104x104x45



**L-99**

Incluye un tapón  
It includes a cap

**SUMIDERO SIFONICO VERTICAL Y HORIZONTAL**  
**VERTICAL OR HORIZONTAL DRAIN FLOOR**  
**SIPHON DE COUR SORTIE VERTICALE OU HORIZONTALE**  
**SUMIDOURO SIFONICO VERTICAL/HORIZONTAL PVC COLAR**

Ref.	Sup (mm) - Ø (mm)			€	Dimensiones A-B-C
6010	104x104 - 50	1	30	5,2852	90x104x104
6011	104x104 Inox - 50	1	30	6,9513	90x104x104



**L-100**

**SUMIDERO SIFONICO VERTICAL**  
**VERTICAL DRAIN FLOOR**  
**AVALOIR SORTIE VERTICALE COLAR**  
**SUMIDOURO SIFONICO VERTICAL COLAR**

Ref.	Sup (mm) - Ø (mm)			€	Dimensiones A-B-C
6020	150x150 - 50-75	-	48	6,9669	151x151x65
6021	200x200 - 90-110	-	20	10,5476	200x200x85
6022	250x250 - 90-110	-	12	15,1236	247x247x87
6023	300x300 - 110-125	-	6	29,2406	300x300x100



**L-103 Alta Resistencia**

**SUMIDERO SIFONICO VERTICAL**  
**VERTICAL DRAIN FLOOR**  
**AVALOIR SORTIE VERTICALE COLAR**  
**SUMIDOURO SIFONICO VERTICAL COLAR**

Ref.	Sup (mm) - Ø (mm)			€	Dimensiones A-B-C
6050	150x150 - 50-75	-	48	15,4440	151x151x65
6051	200x200 - 90-110	-	20	22,3080	200x200x85
6052	250x250 - 90-110	-	12	29,1720	247x247x87



**L-101**

**CALDERETA SIFONICA VERTICAL**  
**VERTICAL BELL DRAIN**  
**SIPHON DE COUR SORTIE VERTICALE AVEC ENTONNOIR**  
**CAIXA SIFONICA EXTENSIVEL VERTICAL COLAR**

Ref.	Sup (mm) - Ø (mm)			€	Dimensiones A-B-C
6030	150x150 - 50-75	-	22	10,1358	216x210x104
6031	200x200 - 90-110	-	12	18,3040	289x275x128
6032	250x250 - 90-110	-	6	22,3194	341x338x143
6033	300x300 - 110-125	-	3	43,8609	423x423x187



**L-102**

**CALDERETA SIFONICA HORIZONTAL**  
**HORIZONTAL BELL DRAIN**  
**SIPHON DE COUR SORTIE HORIZONTAL AVEC ENTONNOIR**  
**CAIXA SIFONICA EXTENSIVEL HORIZONTAL COLAR**

Ref.	Sup (mm) - Ø (mm)			€	Dimensiones A-B-C
6040	150x150 - 75	-	20	10,1358	210x210x106
6041	200x200 - 90	-	10	18,3040	276x276x130
6042	250x250 - 110	-	6	20,2904	333x333x141

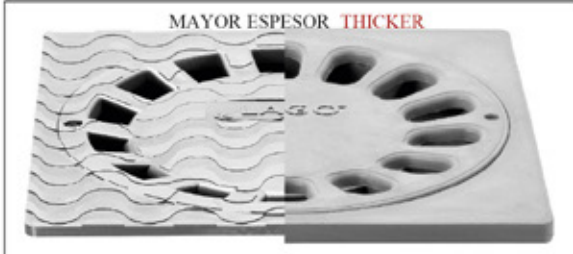
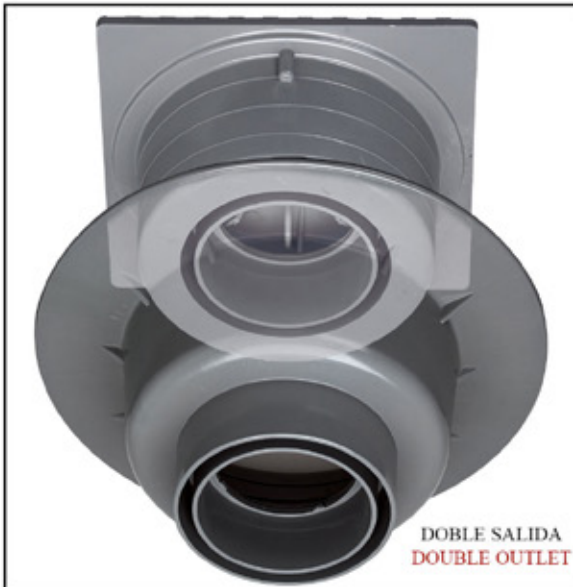

ACTA Nº: AE111139  
MATERIAL ENSAYADO: SUMIDERO  
ALBARÁN Nº: 60514-1

**AIDICO**  
INSTITUTO TECNOLÓGICO DE LA CONSTRUCCIÓN

**SUMIDEROS Y SIFONES PARA EDIFICIOS. MÉTODOS DE ENSAYO. ENSAYO DE CARGA (UNE- EN 1253-2:2004)**

CLASE DE EQUIPO DE CUBRIÓN DE CIERRE	L15
FECHA DEL ENSAYO	27/05/2011

**RESULTADOS DEL ENSAYO:**

COTA DE PASO (mm)	198
DIMENSIÓN PLATO DE CARGA (mm)	Ø 110
FUERZA DE CONTROL (kN)	15
VELOCIDAD DE CARGA (kN/s)	3

FLECHA RESIDUAL (mm) (después de aplicar los 2/3 de la fuerza de control 5 veces):	0,21
---	------

RESULTADO (APARICIÓN O NO DE FISURAS) (después de la aplicación de la fuerza de control):	SATISFACTORIO
--	---------------



Ensayos realizados sobre un sumidero sifónico vertical de 250x250 "ALTA RESISTENCIA" contra la norma UNE-EN- 1253-2:2004 por AIDICO. El resultado es SATISFACTORIO para la categoría L15. La rotura se produjo a 67,72 kN.

La categoría L15 es para, según la norma, "zonas con tráfico de vehículos ligeros, excluidas las carretillas elevadoras de horquilla, utilizadas en recintos comerciales." Para más información consultar la norma de referencia.

Tests performed at a 250x250 vertical drain trap "ALTA RESISTENCIA" against UNE-EN- 1253-2:2004 for AIDICO. The result is SATISFACTORY for the L15 category. The break occurred at 67,72 kN.

The category L15 is for, according to the standard, "areas with light vehicle traffic, other than a forklift, used in commercial venues." For more information see the reference standard.





8 435277 962102



8 435277 962119



8 435277 962201



8 435277 962218



8 435277 962300



8 435277 962409



8 435277 963109



8 435277 963116



8 435277 963130



**L-104**

**BOTE SIFONICO**  
**FLOOR TRAP**  
**BOITE SIPHONIQUE**  
**SIFAO PVC**

Ref.	Ø (mm)			€	Dimensiones A-B-C
6310	110	1	20	8,9481	169x169x103
6311	110 - Corto	1	20	8,9481	169x169x90



**L-104**

**TAPA BOTE SIFONICO**  
**COVER FOR FLOOR TRAP**  
**COUVERCLE POUR BOITE SIPHONIQUE**  
**TAMPA SIFAO PVC**

Ref.	Ø (mm)			€	Dimensiones A-B-C
6313	110	1	50	4,6550	



**L-105**

**MANGUITO INODORO RECTO**  
**SANITARY CONNECTOR**  
**PIPE SANITAIRE**  
**CANHAO SANITA RECTO**

Ref.	Ø (mm)			€	Dimensiones A-B-C
6210	90	-	40	3,8667	137x137x145
6211	110	-	35	3,8667	135x135x146



**L-105**

**MANGUITO INODORO EXCENTRICO**  
**ECCENTRIC SANITARY CONNECTOR**  
**PIPE SANITAIRE EXCENTRIQUE**  
**CANHAO SANITA EXCENTRICO**

Ref.	Ø (mm)			€	Dimensiones A-B-C
6220	90	-	40	3,8667	142x137x146
6221	110	-	35	3,8667	137x137x146



**L-106**

**MANGUITO INODORO RECTO JUNTA LABIADA**  
**SANITARY CONNECTOR WITH LIP JOIN**  
**PIPE SANITAIRE AVEC JOINT A LEVRE**  
**CANHAO SANITA RECTO JUNTA LABIADA**

Ref.	Ø (mm)			€	Dimensiones A-B-C
6230	90	-	35	5,1480	137x137x145



**L-106**

**MANGUITO INODORO EXCENTRICO JUNTA LABIADA**  
**ECCENTRIC SANITARY CONNECTOR WITH LIP JOIN**  
**PIPE SANITAIRE EXCENTRIQUE AVEC JOINT A LEVRE**  
**CANHAO SANITA EXCENTRICO JUNTA LABIADA**

Ref.	Ø (mm)			€	Dimensiones A-B-C
6240	90	-	35	5,1480	135x135x146

## JUNTA ADAPTA

\* La Junta Adapta es la única que se ajusta a la válvula garantizando que no se cae durante su instalación y permite desmontarla y montarla cuando lo necesitamos.

\* La superficie de contacto es la mayor del mercado, ajustándose perfectamente al sanitario.

\* This adjustable joint is the only one that can be adjusted to a valve guaranteeing that it does not fall out during its installation and we can assemble or dismantle it when we need it.

\* The surface contact is the largest of the market, and it can be perfectly adjusted to any bathroom fittings.



**EXCLUSIVA**  
¡La única JUNTA ADAPTA ajustable y con mayor superficie!

**EXCLUSIVE**  
¡The only JUNTA ADAPTA with the largest surface!

Ejemplo sin JUNTA ADAPTA  
Example with no

## SISTEMA ANTI-FUGA

La Junta tórica garantiza la estanqueidad, los topes imposibilitan que se desmonte la pieza durante la instalación del plato de ducha.

The O-Ring guarantees its stagnancy and the tops prevent the piece from being falling apart during the installation of the shower plate.

**EXCLUSIVA**  
¡El único SISTEMA ANTI-FUGA que no permite error humano!

**EXCLUSIVE**  
¡The only SISTEMA ANTI-FUGA that does not olerates human errors!



## SIFON ON-Off

- El casquillo extraíble permite hacerlo sifón según la voluntad del usuario. Es el único que permite acceder a la válvula para su limpieza y desatasque sin desmontar el plato de ducha.

You can convert it to a siphon by removing its ferrule. It is the only one that allows you to access the valve to clean and unblock it without removing the shower plate.

**EXCLUSIVA**  
¡El único SIFON ON-Off de fácil acceso y limpieza!

**EXCLUSIVE**  
¡The only SIFON ON-Off with easy access to clean it!





8 435277 965110



8 435277 965127



8 435277 965134



8 435277 965141



8 435277 965158



8 435277 965165



8 435277 965172



8 435277 965301



8 435277 965318



8 435277 965325



L-2

L-2T

REF.: 6512

REF.: 6513

**SIFON BOTELLE EXTENSIBLE CON / SIN TOMA**  
**ADJUSTABLE BOTTLE TRAP WITH OR WITHOUT INTAKE**  
**SIPHON EVIER EXTENSIBLE AVEC OU SANS PRISE**  
**SIFAO GARRAFA EXTENSIBLE**

Ref.	Ø (" - mm)			€	Dimensiones A-B-C
6512	1 1/2 - 40	1	40	5,6409	76x95x193 (281)
6513	1 1/2 - 40	1	40	6,2025	76x95x193 (281)



L-5

**SIFON BOTELLA EXTENSIBLE 2 TOMAS**  
**ADJUSTABLE BOTTLE TRAP WITH 2 INTAKES**  
**SIPHON EVIER EXTENSIBLE AVEC 2 PRISES**  
**SIFAO GARRAFA EXTENSIBLE 2 TOMAS**

Ref.	Ø (" - mm)			€	Dimensiones A-B-C
6511	1 1/2 - 40	1	30	8,1993	228x95x357 (421)



L-3

**SIFON BOTELLA CON VALVULA Y TAPON**  
**BOTTLE TRAP WITH VALVE AND PLUG**  
**SIPHON EVIER AVEC BONDE EXTENSIBLE ET BOUCHON**  
**SIFAO GARRAFA EXTENSIBLE CON VALVULA Y TACO**

Ref.	Ø (" - mm) - chapa			€	Dimensiones A-B-C
6514	1 1/2 - 40 - 70	1	35	8,3865	78x95x190 (264)
6515	1 1/2 - 40 - 85	1	35	8,8680	78x95x190 (264)
6516	1 1/2 - 40 - 115	1	35	9,9091	78x95x190 (264)



L-4

**SIFON BOTELLA CON VALVULA, TAPON Y CADENA**  
**BOTTLE TRAP WITH VALVE, CHAIN AND PLUG**  
**SIPHON EVIER AVEC BONDE EXTENSIBLE, CHAINE ET BOUCHON**  
**SIFAO GARRAFA EXTENSIBLE CON VALVULA, TACO E CORRENTE**

Ref.	Ø (" - mm) - chapa			€	Dimensiones A-B-C
6517	1 1/2 - 40 - 70	1	35	9,1852	78x95x190 (264)



L-6

L-7

REF.: 6530

REF.: 6531

**SIFON "Y" / SIFON "Y" EXTENSIBLE**  
**"Y" BOTTLE TRAP / ADJUSTABLE "Y" BOTTLE TRAP**  
**SIPHON EVIER "Y" / SIPHON EVIER "Y" EXTENSIBLE**  
**SIFAO "Y" / SIFAO "Y" EXTENSIBLE**

Ref.	Ø (" - mm)			€	Dimensiones A-B-C
6530	1 1/2 - 40	1	50	3,8812	127x55x132
6531	1 1/2 - 40	1	50	4,5926	127x55x206 (272)



L-8

**SIFON "Y" CON VALVULA, TAPON Y CADENA**  
**BOTTLE TRAP WITH VALVE, PLUG AND CHAIN**  
**SIPHON EVIER "Y" AVEC BONDE, BOUCHON ET CHAINE**  
**SIFAO Y CON VALVULA, TACO E CORRENTE**

Ref.	Ø (" - mm) - chapa			€	Dimensiones A-B-C
6532	1 1/2 - 40 - 70	1	50	7,2883	141x75x136 (276)





**SIFON CURVO EXTENSIBLE CON O SIN TOMA**  
 ADJUSTABLE U-BEND BOTTLE TRAP WITH OR WITHOUT INTAKE  
 SIFON COURBE EXTENSIBLE AVEC OU SANS PRISE  
 SIFAO CURVO EXTENSIBLE CON/SIN TOMA

Ref.	Ø (" - mm)			€	Dimensiones A-B-C
6520	1 1/2 - 40	1	40	5,2665	140x55x215 (276)
6521	1 1/2 - 40	1	40	5,8281	140x55x215 (276)



**SIFON CURVO TOMA ELECTRODOMESTICO**  
 U-BEND BOTTLE TRAP WITH WATER EVACUATE INTAKE  
 SIFON COURBE POUR EVACUATION D'EAU  
 SIFAO CURVO TOMA ELECTRODOMESTICO

Ref.	Ø (" - mm)			€	Dimensiones A-B-C
6526	1 1/2 - 40	1	40	4,8422	164x55x190



**SIFON CURVO CON VALVULA Y TAPON**  
 ADJUSTABLE U-BEND BOTTLE TRAPE WITH VALVE AND PLUG  
 SIFON EVIER COURBE EXTENSIBLE AVEC BONDE ET BOUCHON  
 SIFAO CURVO CON VALVULA E TACO

Ref.	Ø (" - mm) - chapa			€	Dimensiones A-B-C
6522	1 1/2 - 40 - 70	1	35	8,0121	157x78x193 (256)
6523	1 1/2 - 40 - 85	1	35	8,4739	157x78x193 (256)
6524	1 1/2 - 40 - 115	1	35	9,5347	



**SIFON CURVO CON VALVULA, TAPON Y CADENA**  
 ADJUSTABLE U-BEND BOTTLE TRAP WITH VALVE, CHAIN AND PLUG  
 SIFON EVIER COURBE EXTENSIBLE AVEC BONDE, BOUCHON ET CHAINE  
 SIFAO CURVO CON VALVULA, TACO E CORRENTE

Ref.	Ø (" - mm) - chapa			€	Dimensiones A-B-C
6525	1 1/2 - 40 - 70	1	35	8,5113	157x78x193 (256)



**SIFON CURVO EXTENSIBLE CON CODO**  
 ADJUSTABLE U-BEND BOTTLE TRAP WITH ELBOW  
 SIFON COURBE ADJUSTABLE AVEC COUDE  
 SIFAO CURVO DUPLO DESLOCADO

Ref.	Ø (" - mm)			€	Dimensiones A-B-C
6540	1 1/2 - 40	1	25	7,8124	362x55x314 (372)
6541	1 1/2 - 40 - 70 y Valvula	1	25	11,1820	378x78x440 (497)



**SIFON BOTELLA DOBLE EVACUACION CON REBOSADERO**  
 DOUBLE EVACUATE BOTTLE TRAP WITH OVERFLOW  
 SIFON A DOUBLE EVACUATION AVEC TROP PLEIN  
 SIFAO DUPLO CON REPIRO

Ref.	Ø (" - mm) - chapa			€	Dimensiones A-B-C
6616	1 1/2 - 40 - 70	1	10	23,6870	
6617	1 1/2 - 40 - 85	1	10	24,6230	
6618	1 1/2 - 40 - 115	1	10	26,7321	





**VALVULA FREGADERO**  
**SANITARY SINK DRAIN VALVE**  
**BONDE POUR EVIER**  
**VALVULA CON TACO**

Ref.	Ø (" - mm) - chapa			€	Dimensiones A-B-C
6410	1 1/2 - 40 - 70	1	50	5,1792	78x78x63
6411	1 1/2 - 40 - 85	1	50	5,6534	
6412	1 1/2 - 40 - 115	1	50	6,7142	



**VALVULA LAVABO-BIDET**  
**SANITARY DRAIN BASIN**  
**BONDE SANITAIRE**  
**VALVULA CON TACO E CORRENTE**

Ref.	Ø (" - mm) - chapa			€	Dimensiones A-B-C
6415	1 1/2 - 40 - 70	1	50	6,0028	78x78x63



**VALVULA SIFONICA PLATO DUCHA**  
**SHOWER PLATE DRAIN VALVE**  
**SIPHON PLATEAU DOUCHE**  
**BASE CHUVEIRO SIFONICA**

Ref.	Ø (" - mm) - chapa			€	Dimensiones A-B-C
6420	1 1/2 - 40 - 80	1	50	3,8188	120x90x72
6421	1 1/2 - 40 - 70 y Tapón	1	50	4,3430	120x90x72



**VALVULA PLATO DUCHA EXTRAPLANA**  
**FLAT DRAIN VALVE FOR SHOWER PLATE**  
**SIPHON PLAT PLATEAU DOUCHE**  
**VALVULA BASE CHUEIRO SALIDA HORIZONTAL**

Ref.	Ø (" - mm) - chapa			€	Dimensiones A-B-C
6425	1 1/2 - 40 - 80	1	50	4,5676	131x82x57



**DOBLE SIFÓN CURVO EXTENSIBLE CON TOMA**  
**U-BEND ADJUSTABLE DOUBLE SIPHON WITH INTAKE**  
**DOUBLE SIPHON COURBE EXTENSIBLE**  
**SIFAO DUPLO CURVO EXTENSIBLE**

Ref.	Ø (" - mm)			€	Dimensiones A-B-C
6630	1 1/2 - 40	1	15	11,9808	554(606)x55x260(287)



**DOBLE SIFÓN CURVO EXTENSIBLE CON VALVULA Y TAPÓN**  
**U-BEND DOUBLE SIPHON WITH VALVE AND PLUG**  
**SIPHON DOUBLE COURBE AVEC BONDE ET BOUCHON**  
**SIFAO DUPLO CURVO CON VALVULA E TACO**

Ref.	Ø (" - mm) - chapa			€	Dimensiones A-B-C
6631	1 1/2 - 40 - 70	1	15	17,3222	571(637)x78x260(265)
6632	1 1/2 - 40 - 85	1	15	18,2707	
6633	1 1/2 - 40 - 115	1	15	20,3673	



**L-15**

**SIFÓN BOTELLA CON DOBLE EVACUACIÓN**  
**BOTTLE TRAP WITH DOUBLE EVACUATE**  
**SIPHON BOUTEILLE A DOUBLE EVACUATION**  
**SIFAO DUPLO CON TOMA**

Ref.	Ø (" - mm)			€	Dimensiones A-B-C
6610	1 1/2 - 40	1	20	9,4598	442(503)x95x276(335)



**L-18**

**SIFON CURVO CON DOBLE EVACUACIÓN**  
**U-BEND SIPHON WITH DOUBLE EVACUATE**  
**SIPHON COURBE A DOUBLE EVACUATION**  
**SIFAO DUPLO CURVO CON TOMA**

Ref.	Ø (" - mm)			€	Dimensiones A-B-C
6620	1 1/2 - 40	1	20	7,5712	463(525)x155x279(340)



**L-16**

**SIFON BOTELLA CON DOBLE EVACUACIÓN EXTENSIBLE**  
**BOTTLE TRAP WITH DOUBLE ADJUSTABLE EVACUATE**  
**SIPHON BOUTEILLE A DOUBLE EVACUATION ADJUSTABLE**  
**SIFAO DUPLO EXTENSIBLE CON TOMA**

Ref.	Ø (" - mm)			€	Dimensiones A-B-C
6611	1 1/2 - 40	1	20	10,8700	442(503)x95x341(433)



**L-19**

**SIFON CURVO CON DOBLE EVACUACIÓN EXTENSIBLE**  
**U-BEND SIPHON WITH DOUBLE ADJUSTABLE EVACUATE**  
**SIPHON COURBE A DOUBLE EVACUATION AJUSTABLE**  
**SIFAO DUPLO EXTENSIBLE CURVO CON TOMA**

Ref.	Ø (" - mm)			€	Dimensiones A-B-C
6621	1 1/2 - 40	1	20	5,8281	463(525)x155x355(431)



**L-17**

**SIFON BOTELLA CON DOBLE EVACUACIÓN, VALVULA Y TAPÓN**  
**BOTTLE TRAP WITH DOUBLE EVACUATE, VALVE AND PLUG**  
**SIPHON BOUTEILLE A DOUBLE EVACUATION AVEC BONDE ET BOUCHON**  
**SIFAO DUPLO EXTENSIBLE CON VALVULA E TOMA**

Ref.	Ø (" - mm) - chapa			€	Dimensiones A-B-C
6612	1 1/2 - 40 - 70	1	15	16,5359	463(525)x95x333(410)
6613	1 1/2 - 40 - 85	1	15	17,4844	463(525)x95x333(410)
6614	1 1/2 - 40 - 115	1	15	19,5935	



**L-20**

**SIFON CURVO CON DOBLE EVACUACIÓN, VALVULA Y TAPÓN**  
**U-BEND SIPHON WITH DOUBLE ADJUSTABLE VALVE AND PLUG**  
**SIPHON COURBE A DOUBLE EVACUATION AVEC BONDE ET BOUCHON**  
**SIFAO DUPLO EXTENSIBLE CON TOMA**

Ref.	Ø (" - mm) - chapa			€	Dimensiones A-B-C
6622	1 1/2 - 40 - 70	1	15	16,1616	442(503)x95x341(433)
6623	1 1/2 - 40 - 85	1	15	17,1100	
6624	1 1/2 - 40 - 115	1	15	19,2067	





8 435277 967107



8 435277 967114



8 435277 967121



8 435277 967152



8 435277 967206



8 435277 967251



8 435277 967305



8 435277 967350



**L-24**

**VALVULA VERTICAL FREGADERO REBOSADERO**  
**VERTICAL SINK DRAIN VALVE WITH OVERFLOW**  
**BONDE D'EVIER VERICALE AVEC TROP PLEIN**  
**VALVULA CON RESPIRO**

Ref.	Ø (" - mm) - chapa			€	Dimensiones A-B-C
6710	1 1/2 - 40 - 70	1	50	9,4494	78x75x447
6711	1 1/2 - 40 - 85	1	25	10,2388	78x75x447
6712	1 1/2 - 40 - 115	1	25	11,1654	



**L-25**

**CONJUNTO VALVULA VERTICAL BAÑERA REBOSADERO**  
**VERTICAL BATHTUB DRAIN VALVE KIT WITH OVERFLOW**  
**KIT BONDE DE BAINOIRE VERICALE AVEC TROP PLEIN**  
**JOGO BANHEIRA SAIDA VERTICAL**

Ref.	Ø (" - mm) - chapa			€	Dimensiones A-B-C
6715	1 1/2 - 40 - 70	1	25	10,4561	78x75x795



**L-26**

**CONJUNTO VALVULA HORIZONTAL BAÑERA REBOSADERO**  
**HORIZONTAL BATHTUB DRAIN VALVE KIT WITH OVERFLOW**  
**KIT BONDE DE BAINOIRE HORIZONTALE AVEC TROP PLEIN**  
**JOGO BANHEIRA SAIDA HORIZONTAL**

Ref.	Ø (" - mm) - chapa			€	Dimensiones A-B-C
6720	1 1/2 - 40 - 70	1	25	11,1311	77x143x800



**L-27**

**CONJUNTO VALVULA VERTICAL BAÑERA REBOSADERO SALIDA PVC**  
**VERTICAL BATHTUB DRAIN VALVE KIT WITH OVERFLOW AND PVC OUTPUT**  
**KIT BONDE DE BAINOIRE VERICALE AVEC TROP PLEIN ET SORTIE PVC**  
**JOGO BAHEIRA SAIDA VERTICAL**

Ref.	Ø (" - mm) - chapa			€	Dimensiones A-B-C
6725	1 1/2 - 40 - 70	1	25	10,7536	78x105x871



**L-28**

**CONJUNTO VALVULA EXTRAPLANA BAÑERA CON REBOSADERO**  
**FLAT BATHTUB VALVE KIT WITH OVERFLOW**  
**KIT BONDE PLATE AVEC TROP PLEIN**  
**JOGO BANHEIRA SAIDA HORIZONTAL EXTRAPLANA**

Ref.	Ø (" - mm) - chapa			€	Dimensiones A-B-C
6730	1 1/2 - 40 - 70	1	25	10,8222	79x69x825



**L-33**

**CONJUNTO VALVULA SIFONICA BAÑERA CON REBOSADERO**  
**SIPHON BATHTUB VALVE KIT WITH OVERFLOW**  
**KIT SIPHON BAINOIRE AVEC TROP PLEIN**  
**JOGO BANHEIRA SAIDA HORIZONTAL SIFONICA**

Ref.	Ø (" - mm) - chapa			€	Dimensiones A-B-C
6735	1 1/2 - 40 - 80	1	25	9,9413	79x69x825



**L-300**

TE TUBOS LISOS TOMA ELECTR.

TEE FOR PLAIN TUBES WITH ELECTR.

TE POUR TUYAU PLAT AVEC PRISELECTR.

TE PARA TUBOS LISOS CON TOMA

Ref. Ø (" - mm) €  
6800 1 1/2 - 40 1 50 4,4075



**L-307**

TE TUBOS LISOS Y MACHO TOMA ELECTR.

TEE FOR MALE PLAIN TUBES WITH ELECTR.

TE POUR TUYAU ET MALE AVEC PRISELECTR.

TE PARA TUBOS LISOS TOMA MACHO

Ref. Ø (" - mm) €  
6801 1 1/2 - 40 1 50 4,1776



**L-305**

ENLACE MACHO PVC

MALE PVC CONNECTOR

RACCORD MALE PVC

UNIAO MISTA PVC

Ref. Ø (" - mm) €  
6802 1 1/2 - 40 1 50 1,7305



**L-316**

90°

ENLACE MACHO PVC TOMA ELECT.

MALE PVC CONNECTOR WITH ELECTR.

RACCORD MALE PVC AVEC PRISE ELECTR.

UNIAO MISTA PVC CON TOMA

Ref. Ø (" - mm) €  
6817 1 1/2 - 40 1 50 3,8350



**L-301**

CODO PARA TUBOS LISOS

ELBOW FOR PLAIN TUBES

COUDE POUR TUYAU PLAT

JOELHO PARA TUBOS LISOS

Ref. Ø (" - mm) €  
6804 1 1/2 - 40 1 50 2,7580



**L-302**

CODO PARA TUBO LISO Y HEMBRA

ELBOW FOR PLAIN TUBES FEMALE

COUDE POUR TUYAU PLAT ET FEME

JOELHO PARA TUBOS LISO E FEMEA

Ref. Ø (" - mm) €  
6805 1 1/2 - 40 1 50 2,5282



**L-303**

ALARGADERA EXTENSIBLE CON TUERCA

ADJUSTABLE EXTENSION WITH SLIDING

PROLONGADOR CON PORCA LOURCA

PROLONGADOR CON PORCA LOUCA

Ref. Ø (" - mm) €  
6806 1 1/2 - 40 1 50 1,9063



**L-310**

VALVULA EXTENSIBLE CON TAPÓN Y CADENA

ADJUSTABLE VALVE WITH PLUG AND CHAI

VANNE EXTENSIBLE AVEC BOUHCON

VALVULA EXTR. C/TACO E CORRENTE

Ref. Ø (" - mm) €  
6807 1 1/2-40-70 1 50 4,8807



**L-311**

JUNTA LABIADA

LIP JOINT

JOINT LABIAL

VEDACAO LABIADA

Ref. Ø (" - mm) €  
6809 90 1 100 2,3254



**L-309**

MANGUITO PARA TUBOS LISOS

CONNECTOR FOR PLAIN TUBES

MANCHON POUR TUYAU PLAT

UNIAO PARA TUBOS LISOS

Ref. Ø (" - mm) €  
6808 1 1/2 - 40 1 50 1,5808



**L-312**

CONJUNTO PARA VALVULA C/ TAPON Y CADENA

SET FOR VALVES WITH PLUG AND CHAIN

COMPLEMENTS POUR VANNE AVEC

CONI PARA VALVULA C/TACO

Ref. Ø (" - mm) €  
6811 1 1/2-40-70 1 50 4,2452



**L-314**

PLAFON

CEILING

PLAFOND

ESPELHO

Ref. Ø (" - mm) €  
6814 40 1 50 0,5948



**L-315**

PLAFON CON ALARGADERA

CEILING WITH ADJUSTABLE

PLAFOND AVEC PROLONGEUR

ESPELHO PROLONGADOR 40

Ref. Ø (" - mm) €  
6815 40 1 50 1,1897



**L-313**

TOMA ELECTRODOMESTICO 90°

ELECTRODOMESTIC INTAKE 90°

PRISE ELECTROMENAGE 90°

TOMA ELECTRODOMESTICO 90°

Ref. Ø (" - mm) €  
6812 1 1 50 2,2848  
6813 1 1/2 1 50 2,2848



8 435277 944009  
8 435277 944016  
8 435277 944023  
8 435277 944030  
8 435277 944047  
8 435277 944054  
8 435277 944061  
8 435277 944078  
8 435277 944085  
8 435277 945006  
8 435277 945013  
8 435277 945020  
8 435277 945037  
8 435277 945044  
8 435277 945051  
8 435277 945068  
8 435277 945075  
8 435277 945082  
8 435277 946003  
8 435277 946010  
8 435277 946027  
8 435277 946034  
8 435277 946041  
8 435277 946058  
8 435277 946065  
8 435277 946072  
8 435277 946089



**FITTING TUERCA**  
THREADED FITTING  
ECROU FITTING  
FITTING PORCA

Ref.	Ø (" - mm)	Icon	Icon	€
4400	16	-	-	0,5381
4401	20	-	-	0,5381
4402	25	-	-	0,8072
4403	32	-	-	0,9821
4404	40	-	-	1,3991
4405	50	-	-	1,7220
4406	63	-	-	2,7714
4407	75	-	-	5,5159
4408	90	-	-	10,6013



**FITTING PRISIONERO**  
PRISONER FITTING  
PRISONNIER FITTING  
FITTING PRISIONERO

Ref.	Ø (" - mm)	Icon	Icon	€
4500	16	-	-	0,3767
4501	20	-	-	0,3767
4502	25	-	-	0,4439
4503	32	-	-	0,4708
4504	40	-	-	0,4977
4505	50	-	-	0,5650
4506	63	-	-	0,5919
4507	75	-	-	0,6322
4508	90	-	-	0,6861



**FITTING TUERCA**  
THREADED FITTING  
ECROU FITTING  
FITTING PORCA

Ref.	Ø (" - mm)	Icon	Icon	€
4600	16	-	-	0,4109
4601	20	-	-	0,4109
4602	25	-	-	0,4843
4603	32	-	-	0,5136
4604	40	-	-	0,5430
4605	50	-	-	0,6163
4606	63	-	-	0,6457
4607	75	-	-	0,6897
4608	90	-	-	0,7485



**FITTING JUNTA**  
O-RING FITTING  
JOINT FITTING  
FITTING BORRACHA

Ref.	Ø (" - mm)	Icon	Icon	€
4700	16	-	-	0,3767
4701	20	-	-	0,3767
4702	25	-	-	0,4439
4703	32	-	-	0,4708
4704	40	-	-	0,4977
4705	50	-	-	0,5650
4706	63	-	-	0,5919
4707	75	-	-	0,6322
4708	90	-	-	0,6861



**TUERCA SANITARIO**  
THREADS  
ECROUS  
PORCA

Ref.	Ø (" - mm)	Icon	Icon	€
6400	1	-	-	0,3657
6401	1 1/2	-	-	0,3974



**TAPON**  
PLUG  
BOUCHON  
TACO

Ref.	Ø (" - mm)	Icon	Icon	€
6402	46	-	-	1,2776



**TAPON Y CADENA**  
PLUG AND CHAIN  
BOUCHON ET CHAINE  
TACO E CORRENTE

Ref.	Ø (" - mm)	Icon	Icon	€
6403	270	-	-	4,3088
6404	380	-	-	6,6937



**CAZOLETA INOX**  
INOX GRILLE  
BOUCHE D'EGOUT  
CACOLETA INOX

Ref.	Ø (" - mm)	Icon	Icon	€
6405	70	-	-	1,4786
6406	85	-	-	1,57396
6407	115	-	-	1,7171



**REBOSADERO INOX**  
OVERFLOW  
DEVERSOIRS  
REBOSADERO INOX

Ref.	Ø (" - mm)	Icon	Icon	€
6408	80	-	-	1,7171



**TORNILLO INOX**  
INOX SCREW  
VISSE INOX  
PARAFUSO INOX

Ref.	Ø (" - mm)	Icon	Icon	€
6409	65	-	-	0,7098
6500	45	-	-	0,4929
6501	35	-	-	0,4452



**CADENA DE BOLAS**  
BALL CHAIN  
CHAINE A BILLES  
CORRENTE DE BOLAS

Ref.	Ø (" - mm)	Icon	Icon	€
6502	270	-	-	1,7171
6503	380	-	-	2,4961



**JUNTA ESTANQUEIDAD**  
WATERTIGHTNESS JOINT  
JOINT D'ETANCHEITE  
VEDACAO PLANA

Ref.	Ø (" - mm)	Icon	Icon	€
6504	70	-	-	0,3974
6505	85	-	-	0,4258



**JUNTA BASE**  
BASE JOINT  
JOINT BASE  
VEDACAO BASE

Ref.	Ø (" - mm)	Icon	Icon	€
6506	70	-	-	0,2839
6507	85	-	-	0,3339
6508	115	-	-	0,4134



**JUNTA CONICA**  
CONICAL JOINT  
JOINT CONIQUE  
VEDACAO CONICA

Ref.	Ø (" - mm)	Icon	Icon	€
6509	1	-	-	0,3020
6600	1 1/2	-	-	0,3497



**JUNTA REDUCCION**  
REDUCTION JOINT  
JOINT DE REDUCCION  
VEDACAO REDUCCION

Ref.	Ø (" - mm)	Icon	Icon	€
6601	1 1/2 - 1 1/4	-	-	0,3974







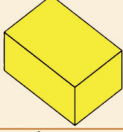

**JUNTA REGISTRO**  
ENTRY JOINT  
JOINT D'ENTREE  
VEDACAO REGISTRO PEQUENA

Ref.	Ø (" - mm)	Icon	Icon	€
6602	Pequeña	-	-	0,3020
6603	Grande	-	-	0,3497

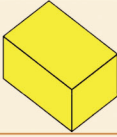

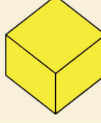

Tipo de caja Type of boxes	REF	Dimensiones (mm) / largo x ancho x alto Size (mm) / length x width x high	Volumen (m3) Volume (m3)	Tipo de caja Type of boxes	REF	Dimensiones (mm) / largo x ancho x alto Size (mm) / length x width x high	Volumen (m3) Volume (m3)
	A5	300 x 200 x 150	0,0090		A3	600 x 400 x 335	0,0804
	A1	400 x 200 x 220	0,0176		A7	600 x 400 x 400	0,0960
	A2	400 x 200 x 440	0,0352		A8	400 x 200 x 500	0,0400
	A4	400 x 400 x 350	0,0560				

#### CONDICIONES GENERALES DE VENTA

- El suministro de materiales, objeto del pedido, se hará conforme a las condiciones generales que se detallan a continuación, las cuales se consideran aceptadas por el cliente una vez realizado el pedido.
- La factura de los distintos materiales, se realizará de acuerdo con los precios de la tarifa vigente en el momento del suministro.
- Las operaciones de compraventa, sea cual sea el lugar de entrega de la mercancía, se entienden realizadas en el domicilio social de ABANILLA RIEGOS, S.A. por lo tanto ambas partes aceptan la competencia de los Juzgados y Tribunales de Alicante, con renuncia a su propio fuero y domicilio.
- Todos nuestros artículos son garantizados por un año de fecha factura, o entrega, de todo defecto de fabricación. Esta garantía queda limitada única y exclusivamente a la sustitución del material que sea considerado como defectuoso, una vez revisado por nuestro técnico de ABANILLA RIEGOS, S.A. teniendo en cuenta que no se admitirán devoluciones ni reclamaciones de material transcurridos 8 días de su recepción, en caso de acuerdo dentro de este plazo, el material deberá sernos remitido perfectamente embalado y dirigido a portes pagados a nuestros almacenes.
- ABANILLA RIEGOS, S.A. se reserva los derechos sin previo aviso de modificar medidas, diseño y variación, composición de materiales, siempre encaminado a la mejora de nuestro producto, a lo que también puede variar las tarifas de precios.
- Esta tarifa anula las anteriores.

#### GENERAL SALE CONDITIONS

- The delivery of the material, object of an order, will be done according to the general conditions that are explained below. Once the client makes an order, it is understood that he/she has accepted these conditions.
- The invoice for different materials will be sent out according to the current price list and normally attached to their supply.
- The buying and selling deals, no matter what the delivery destination is, are understood to be done in ABANILLA RIEGOS, S.A. registered address, thus both parts accept the court of Alicante competence, renouncing to their own privilege and address.
- All our accessories are guaranteed for one year counting from the date printed on the invoice, or delivery, for all manufactured faulties. This guarantee is only limited to the replacement of the material that is considered faulty, once it has been checked by our ABANILLA RIEGOS, S.A. technician. Please, bear in mind that material returns and claims will not be accepted after 8 days of the check in. In case of agreement within this term, this material must be sent to our store fully packed and free of any charge of transport.
- ABANILLA RIEGOS, S.A. reserves its right to modify measures, design and variation, raw material composition without warning, always aimed to improve our product, to which a change of prices can be also applied.
- This price list cancel previous ones.





## ABANILLA RIEGOS, S.A.

C/Camino de Borja 29-31  
(Continuación de Av. Zodiaco)  
03006 Alicante (España)  
Apdo. Correos 5051 - 03080

Tlf.: +34 965 104 874  
Fax: +34 965 104 666  
abrisa@riegos.com

[www.riegos.com](http://www.riegos.com)

